

Installation, Operation and Maintenance Instructions 1100 °C Chamber Furnace - ELF Model: 14 Litres No Controller

ELF 11/14B + No Controller

Contents

This manual is for guidance on the use of the Carbolite Gero product specified on the front cover. This manual should be read thoroughly before unpacking and using the furnace or oven. The model details and serial number are shown on the back of this manual. Use the product for the purpose for which it is intended.

1.0	Symbols and Warnings	4
1.1	Switches and Lights	4
1.2	General Warnings	4
1.3	Prerequisites to Use	5
2.0	Installation	6
2.1	Unpacking and Handling	6
2.2	Siting and Setting Up	6
2.3	Chimney	7
2.4	Hearth	8
2.5	Door Vents	8
2.6	Electrical Connections	8
3.0	Temperature Controller	10
4.0	Operation	11
4.1	Operating Cycle	11
4.2	General Operating Notes	11
4.3	Use of Probes and Metal Sheathed Thermocouples	12
4.4	Atmospheres	12
4.5	Operator Safety	12
4.6	Power Adjustment	13
5.0	Maintenance	14
5.1	General Maintenance	14
5.2	Maintenance Schedule	14
5.2.1	Cleaning	16
5.3	Safety Switch	16
5.4	Calibration	16
5.5	After-Sales Service	17
5.6	Recommended Spare Parts and Spare Parts Kit	17
6.0	Repairs and Replacements	18
6.1	Safety Warning - Disconnection from Power Supply	18
6.2	Safety Warning - Refractory Fibre Insulation	18
6.3	Temperature Controller Replacement	18
6.4	Solid-state Relay Replacement	19

6.5	Thermocouple Replacement	19
6.6	Element Replacement	20
6.7	Fuse Replacement	21
6.8	Door Plug Replacement	21
6.9	Air Inlet Adjustment	22
7.0	Fault Analysis	23
A.	Furnace Does Not Heat Up	23
B.	Product Overheats	24
8.0	Wiring Diagrams	25
8.1	WA-11-30	25
8.2	WA-11-31	26
9.0	Fuses and Power Settings	27
9.1	Fuses	27
9.2	Power Limit	27
10.0	Specifications	28
10.1	Environment	28

1.0 Symbols and Warnings

1.1 Switches and Lights



Instrument switch: when the instrument switch is operated the temperature control circuit is energised.



Heat light: the adjacent light glows or flashes to indicate that power is being supplied to the elements.

1.2 General Warnings



DANGER – Electric shock. Read any warning printed next to this symbol.

WARNING: Risk of fatal injury.



DANGER – Hot surface. Read any warning printed next to this symbol.

WARNING: All surfaces of a product may be hot.



DANGER – Read any warning printed next to this symbol.

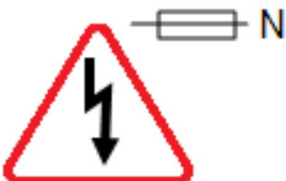

Caution – Double Pole/Neutral Fusing

1.3 Prerequisites to Use

Prior to the commissioning and use of this product, all personnel involved in its installation, operation and maintenance must be deemed competent and have:

- Read and understood the information contained within this manual
- Received the relevant training with regard to safety and operation of the product
- Been provided with the appropriate PPE (Personal Protective Equipment) required for the safe operation of this product

Note: The customer is responsible for ensuring that all of the above conditions are satisfied before the product is commissioned for use.



Note: Unless otherwise specified, the customer is responsible for the installation of this product and the safe connection of any additional equipment and gas or liquid supply lines.

2.0 Installation

2.1 Unpacking and Handling

When unpacking and handling the product, always lift it by its base. Do not use the door or any other projecting cover or component to support the equipment when moving it. Use two or more people to carry the product where possible.

Carefully remove any packing material from inside and around the product before use. Avoid damaging the surrounding insulation when removing packing materials.



NOTE: This product contains Refractory Ceramic Fibre (also known as Alumino Silicate Wool - ASW). For precautions and advice on handling this material see section 6.2.

2.2 Siting and Setting Up

Place the product on a level surface in a well ventilated area.

Site away from other sources of heat and on a non-flammable surface that is resistant to accidental spillage or hot materials.

The surface on which the equipment is mounted should be stable and not subject to movement or vibrations.

The height of the mounting surface is important to avoid operator strain when loading and unloading samples.

Unless otherwise stated elsewhere in this manual, ensure that there is **at least 150 mm** of free space around the back and sides of the product. Clear space is required above the product to dissipate heat.

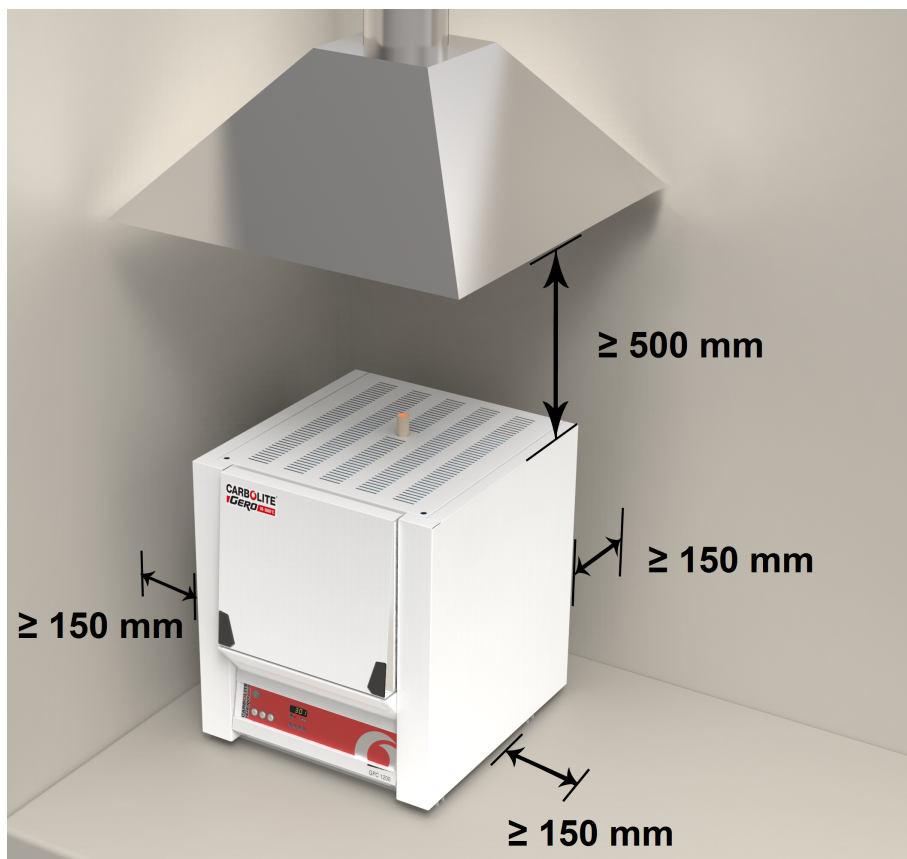

Depending on the application of the product, it may be appropriate to position it under an extraction hood. Ensure the extraction hood is switched on during use.

Ensure that the product is placed in such a way that it can be quickly switched off or disconnected from the electrical supply.



Under no circumstances should any objects be placed on top of the product. Always ensure that any vents on the top of the product are clear of any obstruction. Always ensure all cooling vents and cooling fans (if fitted) are clear of any obstruction.

2.3 Chimney

The chimney is a length of tubing. If it is supplied unfitted, then fit it through the hole in the top of the case.

If the product is to be used to heat substances that emit fumes, a fume extraction duct of approximately 75 mm - 150 mm inlet diameter may be placed directly above the chimney outlet.

Do not make a sealed connection to the product chimney as this causes excessive airflow through the chamber and results in poor temperature uniformity.

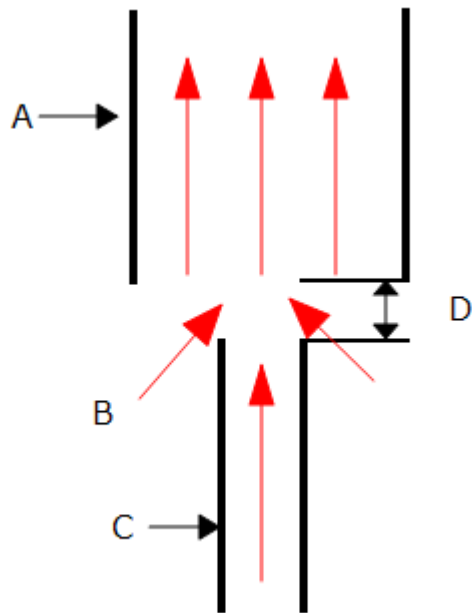

Key	
A	Duct (75mm-150mm diameter)
B	Ambient air is drawn into duct
C	Chimney
D	25mm vertical gap between chimney and duct

2.4 Hearth

The chamber floor (hearth) is supplied with a ceramic tile. This may already be in position in the chamber. If it is packed separately, unwrap it and place it carefully on the chamber floor.

2.5 Door Vents

There is a plate fixed to the inner door panel (door plug carrier), accessible by removing the door insulation piece. This can be positioned to open up holes in the inner door, to allow an increased air flow in the chamber. Decide on the required position and fix the plate accordingly (see section 6.9).

2.6 Electrical Connections



Connection by a qualified electrician is recommended.

The product covered by this manual normally requires a single phase A.C. supply, which may be Live to Neutral non-reversible, Live to Neutral reversible or Live to Live. Some models may be ordered for 3-phase use, which may be with or without neutral.

Check the product rating label before connection. The supply voltage should agree with the voltage on the label and the supply capacity should be sufficient for the current on the label.

The supply should be fused at the next size equal to, or higher than the current on the label. This manual contains a table of the most common fuse ratings.

When the mains cable is factory fitted, internal fuses are also fitted. It is essential that the operator ensures that the product is correctly fused.

Products with a factory fitted supply cable are designed to be wired directly to an isolator or fitted with a line plug.

Products without a factory fitted supply cable require a permanent connection to a fused and isolated supply. The product's electrical access panel should be temporarily removed, and connections made to the internal terminals.

When connecting the product to the power supply, the plug or isolating switch should be accessible, easy to remove, and within reach of the operator.

The supply **MUST** incorporate an earth (ground).

Electrical Connection Details:

Supply	Terminal Label	Cable Colour	Supply Types	
			Live - Neutral	Reversible or Live-Live
1-phase	L1	Brown	to live	to either power conductor (For USA 200-240V, connect L1)
	N / L2	Blue	to neutral	to the other power conductor (For USA 200-240V, connect L2)
	PE	Green/ Yellow	to earth (ground)	to earth (ground)

3-phase	L1	Black	to phase 1
	L2	Black	to phase 2
	L3	Black	to phase 3
	N	Light Blue	to neutral (if fitted)
	PE	Green/ Yellow	to earth (ground)



DO NOT connect a product ordered for three phase use to a single phase supply or to the wrong type of three phase supply.

3.0 Temperature Controller

If this product is fitted with a temperature controller, instructions are provided separately.

4.0 Operation

4.1 Operating Cycle

This product is fitted with an instrument switch which cuts off power to the control circuit.

Connect the product to the electrical supply.

Turn on the instrument switch to activate the temperature controllers. The controllers illuminate and go through a short test cycle.

As the product heats up, the heat light glows steadily at first and then flashes as the product approaches the desired temperature. For more information on temperature control see the controller instructions.

To turn the product off, set the instrument switch to its off position. The controller display will go blank. If the product is to be left unattended, isolate it from the electrical supply.

4.2 General Operating Notes



Heating element life is shortened by overheating. Do not leave the product at high temperature when it is not required. The maximum temperature is shown on the product rating label and in section 10.0 towards the back of this manual.

When heating large objects, in particular poor conductors, avoid shielding the thermocouple from the heating elements. The thermocouple is intended to sense the temperature near the heating elements. However, if a large object is placed in the chamber it may record the average temperature of the object and the elements, this can lead to overheating of the elements. Allow large objects to gain heat at a lower temperature and then reset the controller to a temperature close to the desired maximum, or heat using a slowly controlled ramp rate. For more information refer to the controller instructions.

When heating materials that produce smoke or fumes, the chimney must be correctly fitted and unobstructed. If not, soot will accumulate in the chamber and could possibly cause an electrical breakdown of the heating element. If the furnace is used to heat materials that emit smoke or fumes, regularly heat it up to maximum temperature for one hour with the chamber empty to burn away the soot.

Materials such as case hardening compounds and other reactive salts may penetrate the furnace chamber lining and attack the wire elements, causing premature failure. Use of a hearth tile may be advisable: please consult the Carbolite Gero technical department.

4.3 Use of Probes and Metal Sheathed Thermocouples



Any metal object used to probe into the product chamber while the product is connected to the electrical supply must be earthed. This applies in particular to metal sheathed thermocouples, where the sheaths must be earthed. The refractory material of the chamber lining becomes partly conductive at high temperatures and the electric potential inside the chamber can be at any value between zero and the supply voltage. Unearthed probes can cause serious electric shock.

4.4 Atmospheres

When an optional gas inlet is fitted, there is a label near the inlet saying "INERT GAS ONLY". In practice, inert or oxidising gases may be used, but not combustible or toxic gases.

The chamber is not gas tight, the gas usage may be high and the chamber is always likely to contain some air. Residual oxygen of approximately 1% to 2% is to be expected.

4.5 Operator Safety



This product incorporates a safety switch which interrupts the heating element circuit when the furnace is opened. This prevents the operator touching a live heating element and also prevents the product from heating up if the furnace is left open. The operation of this switch should be checked periodically.



Depending on use, the surfaces in the working chamber and the chamber load may still be very hot after the appliance is switched off. Touching these surfaces may cause burns. Use suitable personal protective equipment or wait until the appliance cools down to ambient temperature.

Before removing a hot object from the product, make sure there is a safe place to put it down. If necessary use tongs, face masks and heat resistant gloves. Heat resistant clothing and face protection can guard against the effects of radiated heat when the furnace is open.

When the product is opened during operation there is considerable radiated heat. Do not keep any flammable objects near the product, nor objects which could be damaged by radiated heat.

4.6 Power Adjustment

The product control system incorporates electronic power limiting. Depending on the model and the destination country the power limit may be set to 100% or a lower figure. Where appropriate the power limit parameter OP.Hi is accessible to the operator, but it should not generally be altered.

See section 9.0 for details of the power limit settings. DO NOT adjust the power to a level higher than the design level states; this may cause a fuse to blow and could damage the heating elements.

The power limit may be set to a lower limit if the product is to be used at a low temperature only: this may give better control stability. It may be set to zero to permit demonstration of the controls without the heating elements taking power; to resume heating reset it to its standard value.

5.0 Maintenance

5.1 General Maintenance

Preventive rather than reactive maintenance is recommended. The type and frequency depends on the product use; the following are recommended.















5.2 Maintenance Schedule

 CUSTOMER

 QUALIFIED PERSONNEL



DANGER! ELECTRIC SHOCK. Risk of fatal injury. Only electrically qualified personnel should attempt these maintenance procedures.

Maintenance Procedure	Method	Frequency				
		Daily	Weekly	Monthly	Bi-Annually	Annually
Safety						
Safety Switch Function	Set a safe temperature above ambient, and open the door to see if the heater light goes out					
Safety Switch Function	Electrical measurement 					
Over-Temperature Safety Circuit (if fitted)	Set an over-temperature setpoint lower than the displayed temperature and check for an over-temperature alarm as detailed in this manual					
Over-Temperature Safety Circuit (if fitted)	Electrical measurement 					
Door Plug	Visual inspection, checking the seal and whether it is free of damage					
Door Plug	Replacement where necessary					
Chimney / Extraction	Check and clean if necessary					
Electrical Safety (external)	Visual check of external cables and plugs					
Electrical Safety (internal)	Physically check all connections and cleaning of the power plate area					
Function						
Temperature Calibration	Tested using certified equipment, frequency dependent on the standard required					

Operational Check	Check that all functions are working normally					
Operational Check	Thorough inspection and report incorporating a test of all functions					6
Performance						
Element Circuit	Electrical measurement 					6
Power Consumption	Measure the current drawn on each phase / circuit					6
Hearth	Visual check for fit and damage					
Cooling Fans (if fitted)	Check whether the cooling fans are working					

5.2.1 Cleaning

Soot deposits may form inside the furnace, depending on the process. At appropriate intervals remove these by heating as indicated in the General Operation Notes.



The product's outer surface may be cleaned with a damp cloth. Do not allow water to enter the interior of the case or chamber. Do not clean with organic solvents.

5.3 Safety Switch

When correctly functioning, the safety switch will isolate all live conductors (live and neutral connections) within the heating element circuit(s) when the product door is opened. The safety switch should be checked regularly to ensure that this occurs.

The safety switch should not fail under normal working conditions, however rough handling, exposure to corrosive materials/ environments, or exceptionally frequent use, could compromise the safety system.

Weekly check:

The following check can be carried out by a general operator:

- On the temperature controller, set a safe temperature above ambient. The heater lights should illuminate.
- Open the door and check the heater lights. They should no longer be illuminated.

If the heater lights remain illuminated when the door is open, discontinue use and contact Carbolite Gero Service.

Annual check:

The following checks should be carried out by a qualified electrician, as specified in the "Maintenance Schedule" section of this manual:

- Remove the element access panel and take a voltage measurement from the heating element terminals. Do not attempt to take a reading from the heating element itself as surface oxidation will give an unreliable contact.
- Ensure that power to the heating elements is switched off when the door is opened.

Contact Carbolite Gero Service and discontinue use of the product if it is found that the heating elements are not fully isolated during these checks.

5.4 Calibration

After prolonged use, the controller and/or thermocouple may require recalibration. This is important for processes that require accurate temperature readings or for those that

use the product close to its maximum temperature. A quick check using an independent thermocouple and temperature indicator should be made from time to time to determine whether full calibration is required. Carbolite Gero can supply these items.

Depending on the controller fitted, the controller instructions may contain calibration instructions.

5.5 After-Sales Service

Carbolite Gero Service has a team of Service Engineers who can offer repair, calibration and preventive maintenance of furnace and oven products both at the Carbolite Gero factory and at customers' premises throughout the world. A telephone call or email often enables a fault to be diagnosed and the necessary parts to be despatched.

In all correspondence please quote the serial number and model type given on the rating label of the product. The serial number and model type are also given on the back of this manual when supplied with the product.

Carbolite Gero Service and Carbolite Gero contact information can be found on the back page of this manual.

5.6 Recommended Spare Parts and Spare Parts Kit

Carbolite Gero can supply individual spare parts or a kit of the items most likely to be required. Ordering a kit in advance can save time in the event of a breakdown.

Each kit consists of one thermocouple and sheath, one solid state relay, one door insulation piece and one complete heating chamber.

When ordering spare parts please quote the model details as requested above.

6.0 Repairs and Replacements

6.1 Safety Warning - Disconnection from Power Supply



Immediately switch the product off in the event of unforeseen circumstances (e.g. large amount of smoke). Allow the product to return to room temperature before inspection.



Always ensure that the product is disconnected from the electrical supply before repair work is carried out.

Caution: Double pole/neutral fusing may be used in this product.

6.2 Safety Warning - Refractory Fibre Insulation



Insulation made from High Temperature Insulation Wool Refractory Ceramic Fibre, better known as (Alumina silicate wool - ASW).

This product contains **alumino silicate wool** products in its thermal insulation. These materials may be in the form of blanket or felt, formed board or shapes, slab or loose fill wool.

Typical use does not result in any significant level of airborne dust from these materials, but much higher levels may be encountered during maintenance or repair.

Whilst there is no evidence of any long term health hazards, it is strongly recommended that safety precautions are taken whenever the materials are handled.

Exposure to fibre dust may cause respiratory disease.

When handling the material, always use approved respiratory protection equipment (RPE-eg. FFP3), eye protection, gloves and long sleeved clothing.

Avoid breaking up waste material. Dispose of waste in sealed containers.

After handling, rinse exposed skin with water before washing gently with soap (not detergent). Wash work clothing separately.

Before commencing any major repairs it is recommended to make reference to the European Association representing the High Temperature Insulation Wool industry (www.ecfia.eu).

Further information can be provided on request. Alternatively, Carbolite Gero Service can quote for any repairs to be carried out either on site or at the Carbolite Gero factory.

6.3 Temperature Controller Replacement

Refer to the controller instructions for more information on how to replace the temperature controller.

6.4 Solid-state Relay Replacement



Disconnect the product from the power supply and remove the appropriate cover as given above.

1. Make a note of the wire connections to the solid state relay, then disconnect them.
2. Remove the solid state relay from the base panel or aluminium plate.
3. Replace and reconnect the solid state relay ensuring that the bottom of it has good thermal contact with the base panel or aluminium plate.
4. Replace the access panel.

6.5 Thermocouple Replacement



Disconnect the product from the power supply. Remove the appropriate panel to gain access to the thermocouple connections. Make a note of the thermocouple connections.

Thermocouple cable colour codings are:

Thermocouple leg	Colour
positive (type K)	green
negative	white

Disconnect the thermocouple from its terminal block and withdraw the thermocouple from its sheath by bending the metal tag or releasing the screw to release. It is also advisable to remove the sheath and shake out any broken pieces of thermocouple.

Re-assemble with a new thermocouple, observing the colour coding, ensuring that the thermocouple is not twisted as it is being inserted and that the metal tag is bent back to grip the sheath.

Refit the element access panel.

6.6 Element Replacement



See section 6.2 - wearing a face mask is required.

The element is supplied in the form of a complete inner chamber.

Disconnect the furnace from the electrical supply and remove the furnace case back panel. Pull the chimney out of the top of the furnace.

Make a note of the wiring connections. Also see section 6.5 for details on the thermocouple colours.

Disconnect the element power leads and the thermocouple connections. Remove the thermocouple and sheath.

Using a socket spanner undo the four bolts that fasten the insulation box. These are located under the insulation box in the two cross supports.

Remove the insulation box by carefully sliding it out through the back of the furnace case.

Take the new insulation box and carefully slide it into the back of the furnace up to the front face. DO NOT support the insulation box by putting your hand inside it – the insulation is fragile.

Locate the insulation box fixing holes and replace the four bolts.

Refit the chimney, thermocouple support tube and thermocouple.

Remake all the thermocouple and element connections according to the notes made. If in doubt, see the diagram below: on the 200-240 V models there are two heating coils in series; on the 100-120 V models two in parallel.

If necessary, cut off any excess wire.

Refit the back panel and operate the furnace for 30 minutes at 800 °C without interruption to ensure complete burn-off of any organic binders. Smoke may be observed during this process, so it should be carried out in a well-ventilated area.

Check that the furnace is controlling properly to rule out the possibility that previous element failed because of a fault elsewhere in the control circuit.

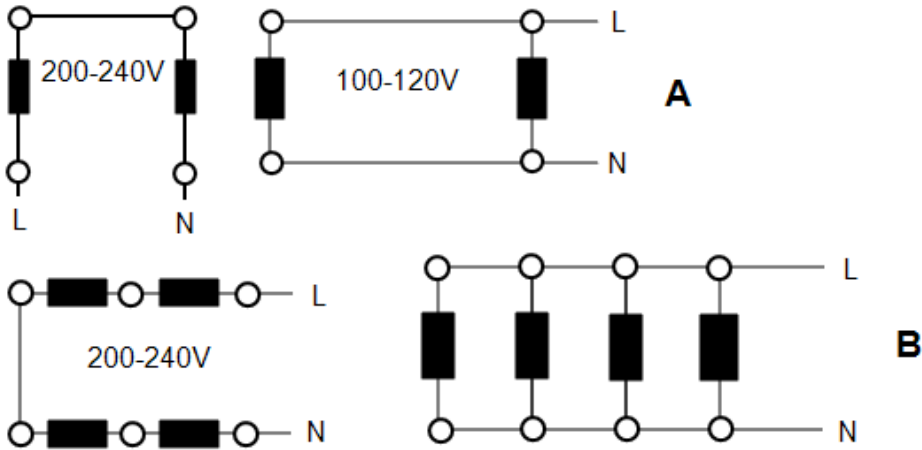
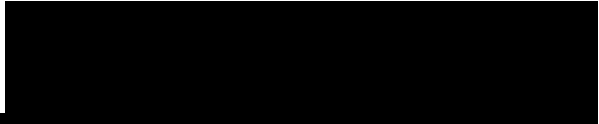

Key	
	Element
A	ELF 11/6 & 11/14
B	ELF 11/23
L	Live
N	Neutral

6.7 Fuse Replacement

Fuses are marked on the wiring diagram with type codes, e.g. F1, F2. For more information on fuses refer to section 9.0.

Depending on model and voltage, the different fuse types may or may not be fitted.

If any fuse has failed, it is advisable for an electrician to check the internal circuits.

Replace any failed fuses with the correct type. For safety reasons do not fit larger capacity fuses without first consulting Carbolite Gero.

The fuses are located at the cable entry point. Remove the back panel or control box back panel to gain access to the fuses.

6.8 Door Plug Replacement



See section 6.2 - wearing a face mask is required.

The “door plug” is also known as the “door insulation piece”.

Lower the furnace door to the fully open position.

Loosen the four M6 Screws, two on either side of the door plug carrier.

Remove the door plug and carrier.

Remove the air inlet blanking plate screws (see section 6.9).

Slide the door plug upwards out of the carrier.

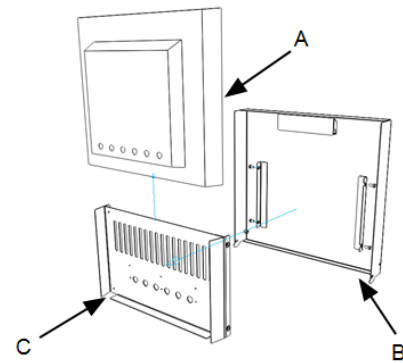

Slide the new door plug into the carrier ensuring that the air inlet holes are aligned and re-assemble in the reverse order.

Key	
A	Door Plug
B	Door
C	Door Plug Carrier

6.9 Air Inlet Adjustment

The air inlet is on the inner door panel (door plug carrier), and is supplied in the closed position. It can be altered to the open position as follows. Remove the door plug and carrier as described in section 6.8.

Remove the three screws holding the blanking plate into position and remove the blanking plate. Position the blanking plate in the upper position clear of the air inlet holes and align the screw holes. Replace the three screws to hold the blanking plate in new position.

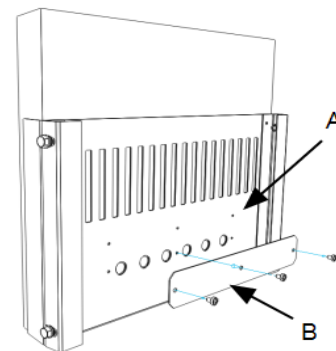

Key	
A	Air Inlet Open Position
B	Blanking Plate

Note that the screws must be replaced to fix the door plug into position.

7.0 Fault Analysis

A. Furnace Does Not Heat Up					
1.	The HEAT light is ON	▶	The heating element has failed	▶	Check also that the SSR is working correctly
2.	The HEAT light is OFF	▶	The controller shows a very high temperature or code such as S.br	▶	The thermocouple has broken or has a wiring fault
		▶	The controller shows a low temperature	▶	The door switch(es) (if fitted) may be faulty or need adjustment
				▶	The contactor/relay (if fitted) may be faulty
				▶	The heater switch (if fitted) may be faulty or need adjustment
				▶	The SSR could be failing to switch on due to internal failure, faulty logic wiring from the controller, or faulty controller
		▶	There are no lights glowing on the controller	▶	Check the supply fuses and any fuses in the furnace control compartment
				▶	The controller may be faulty or not receiving a supply due to a faulty switch or a wiring fault.

B. Product Overheats

1.	Product only heats up when the instrument switch is ON	▶	The controller shows a very high temperature	▶	The controller is faulty
		▶	The controller shows a low temperature	▶	The thermocouple may be faulty or may have been removed out of the heating chamber
				▶	The thermocouple may be connected the wrong way around
				▶	The controller may be faulty
2.	Product heats up when the instrument switch is OFF	▶	The SSR has failed "ON"	▶	Check for an accidental wiring fault that could have overloaded the SSR

8.0 Wiring Diagrams

8.1 WA-11-30

Connections below show single phase with indirect safety switch(es).

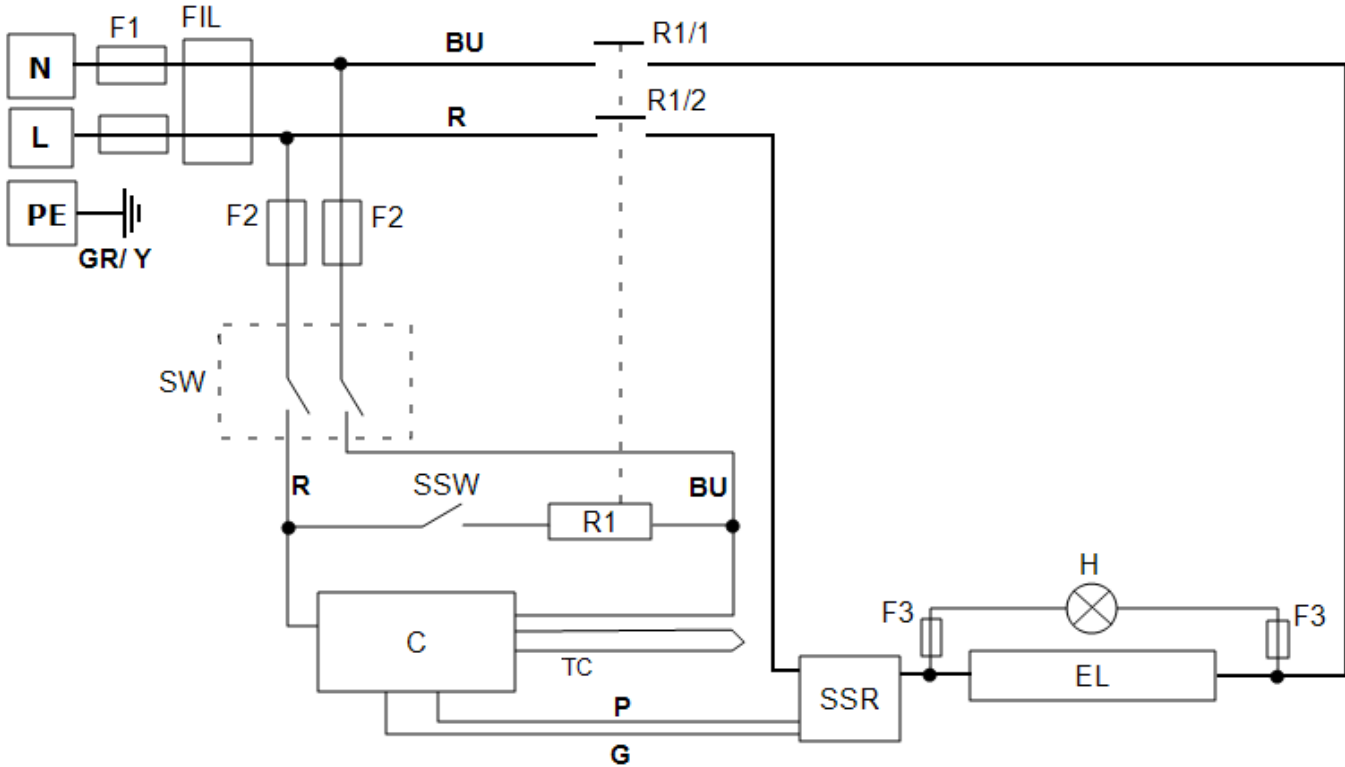

Key	
F1, F2, F3	Fuses
FIL	Filter
R1/1, R1/2	Relay Contactor
R1	Relay
C	Temperature Controller
TC	Control Thermocouple
SSR	Solid State Relay
SSW	Safety Switch
H	Heat Lamp
EL	Element(s)
SW	Instrument Switch(es)
N	Neutral
L	Live
PE	Earth

Cables	
BU	Blue
R	Red
GR/Y	Green + Yellow
G	Grey
P	Pink

8.2 WA-11-31

Connections below show single phase with safety switches and over-temperature control.

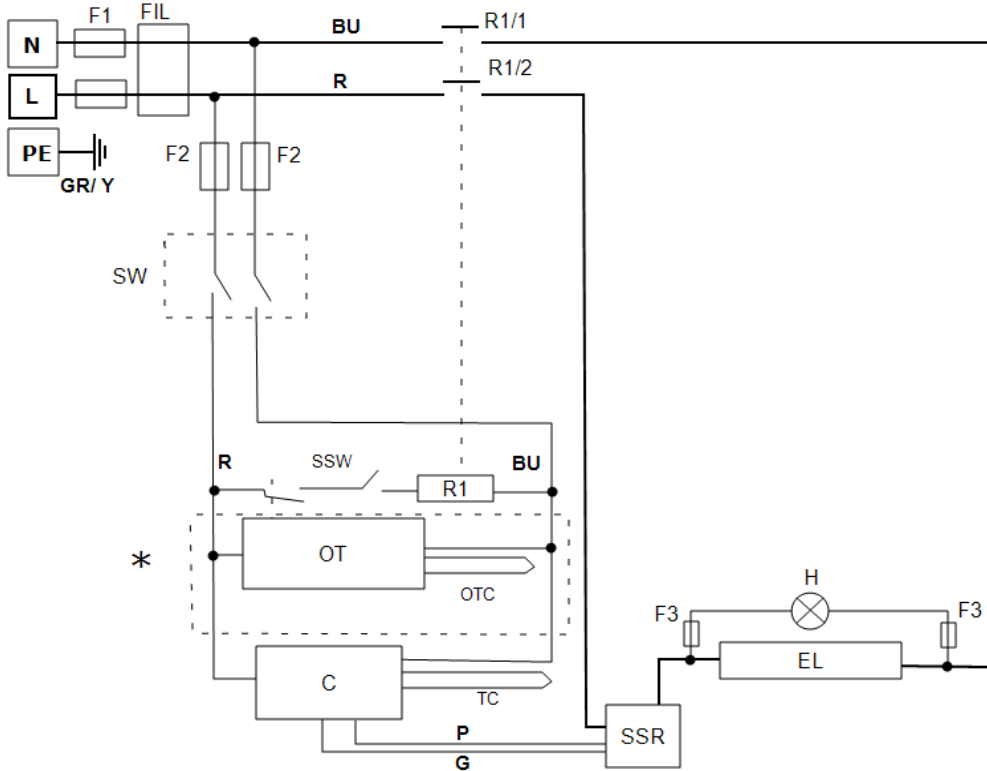

Key	
F1, F2, F3	Fuses
FIL	Filter
R1/1, R1/2	Relay Contactor
R1	Relay
C	Temperature Controller
OT	Over-Temperature Controller
OTC	Over-Temperature Thermocouple
TC	Control Thermocouple
SSR	Solid State Relay
SSW	Safety Switch
H	Heat Lamp
EL	Element(s)
SW	Instrument Switch(es)
N	Neutral
L	Live
PE	Earth
*	If Fitted

Cables	
BU	Blue
R	Red
GR/Y	Green + Yellow
G	Grey
P	Pink

9.0 Fuses and Power Settings

9.1 Fuses

F1 - F2: Refer to the circuit diagrams.

F1	Internal Supply Fuses	Fitted if supply cable fitted. Fitted on board to some types of EMC filter.	38 mm x 10 mm type F fitted on EMC filter circuit board(s)
F2	Auxiliary Circuit Fuses	Fitted on board to some types of EMC filter. May be omitted up to 25 Amp/phase supply rating.	2 Amps glass type F On board: 20 mm x 5 mm Other: 32 mm x 6 mm
	Customer Fuses	Required if no supply cable fitted. Recommended if cable fitted.	See rating label for current; See table below for fuse rating.

Model	Phases	Volts	Supply fuse Ratings (Amps) F1	Aux. Fuse F2	Customer Fuse Rating
ELF 11/14B	1-phase	200 - 240 V	16 A	2 A	13 A
ELF 11/14B	1-phase	100 - 120 V	25 A	2 A	25 A

9.2 Power Limit

The furnace control system incorporates electronic power control, including a "power limit" parameter that is used to reduce the effective voltage to 208 V (or 104 V); the values of the power limit for different voltages are as follows:

Voltage:	100 V	104 V	110 V	115 V	120 V
	200 V	208 V	220 V	230 V	240 V
Power (%):	100	100	89	81	75

Please refer to the rating label for product specific information.

10.0 Specifications

Carbolite Gero reserves the right to change the specification without notice.

Model	Max Temp (°C)	Max Power (kW)	Chamber Size (mm)			Approx Capacity (l)	Net Weight (kg)
			H	W	D		
Chamber furnaces heated by coiled resistance wire embedded in light weight ceramic fibre forming the furnace chamber.							
ELF 11/14B	1100	2.6	200	220	315	13.8	31

10.1 Environment

The models listed in this manual contain electrical parts and should be stored and used in indoor conditions as follows:

Temperature: 5 °C - 40 °C

Relative humidity: Maximum 80 % up to 31 °C decreasing linearly to 50 % at 40 °C

Notes

.....

.....

.....

.....

.....

.....

.....

.....

.....

.....

.....

.....

.....

.....

Service Record

Engineer Name	Date	Record of Work

ProductLabel

The products covered in this manual are only a small part of the wide range of ovens, chamber furnaces and tube furnaces manufactured by Carbolite Gero for laboratory and industrial use. For further details of our standard or custom built products please contact us at the address below, or ask your nearest stockist.

For preventive maintenance, repair and calibration of all furnace and oven products, please contact:

Carbolite Gero Service

Telephone: + 44 (0) 1433 624242

Fax: +44 (0) 1433 624243

Email: ServiceUK@carbolite-gero.com

Carbolite Gero Ltd,

Parsons Lane, Hope, Hope Valley,
S33 6RB, England.

Telephone: + 44 (0) 1433 620011

Fax: + 44 (0) 1433 621198

Email: Info@carbolite-gero.com

www.carbolite-gero.com

CARBOLITE
GERO 30-3000°C

Copyright © 2021 Carbolite Gero Limited



Installation, Operation and Maintenance Instructions
Controller Manual
301 Controller

301 Controller

Contents

This manual is for guidance on the use of the Carbolite Gero product specified on the front cover. This manual should be read thoroughly before unpacking and using the furnace or oven. The model details and serial number are shown on the back of this manual. Use the product for the purpose for which it is intended.

1.0	301 Controller	4
1.1	PID control	4
1.2	Basic Operation of the 301 Controller	4
1.2.1	Menu System	5
1.2.2	Navigation Diagram	5
1.2.3	Basic Function Guide	7
1.2.4	Home Display	8
1.2.5	Hold Mode	8
1.2.6	Checking the Temperature Setpoint from the Home Display	9
1.2.7	Changing the Temperature Setpoint	9
1.2.8	Changing the Temperature Setpoint Ramp Rate	9
1.2.9	Changing the Timer Time	10
1.3	Advanced Operation	10
1.3.1	Entering the Setup menu	10
1.3.2	Changing the Timer Type	10
1.3.3	Changing the Timer Band	11
1.3.4	Changing the Maximum Output Power	11
1.3.5	Changing the Customer Calibration Type	12
1.3.6	Calibration Password	12
1.4	Temperature Setpoint Ramp Rate	12
1.4.1	Setpoint Ramp Rate	12
1.4.2	Limitations of Setpoint Ramp Rate	12
1.5	The Timer	13
1.5.1	Starting the Timer	13
1.5.2	Checking the Time Remaining	13
1.5.3	Pausing the Timer	13
1.5.4	Resetting the Timer	14
1.5.5	Timer Function Description	14
1.5.6	The Timer Temperature Band	15
1.5.7	Timer Function Table	16
1.6	Ramp Dwell Programming	17
1.6.1	Setting up a Ramp Dwell program	17
1.7	Maximum Output Setting	19
1.8	Customer Calibration	19
1.8.1	Factory Calibration - FAct	19

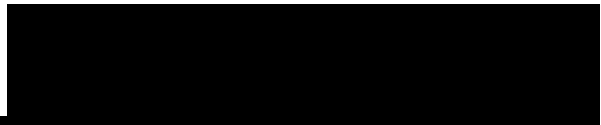

- 1.8.2 Single Point Calibration - C.CL1 20
- 1.8.3 Changing the Single Point Calibration Offset - OFSt 20
- 1.8.4 Dual Point Calibration - C.CL2 20
- 1.8.5 Changing the Calibration, Low Temperature - CAL.L 21
- 1.8.6 Changing the Calibration, Low Temperature Offset - OFS.L 21
- 1.8.7 Changing the Calibration, High Temperature - CAL.H 21
- 1.8.8 Changing the Calibration, High Temperature Offset - OFS.H 22
- 1.9 Over-Temperature Protection 23
 - 1.9.1 Over-Temperature (O/T) home display 23
 - 1.9.2 Changing the Over-Temperature Limit 24
 - 1.9.3 Checking the Over-Temperature Sensor Temperature 24
 - 1.9.4 Over-Temperature Protection Calibration 25
 - 1.9.5 Over-Temperature Activation 25
 - 1.9.6 Resetting Over-Temperature Activation 26
- 1.10 RS232 Communication Option 27
- 1.11 Temperature Controller Replacement 27
- 1.12 Glossary of Terms 28
- 1.13 Controller Fault 28

1.0 301 Controller

Due to the complex nature of the furnace or oven control the use of technical terms throughout this manual is unavoidable. Explanations of these terms can be found in the "Glossary of Terms".

1.1 PID control

This controller uses PID (Proportional Integral Derivative) temperature control. This type of control uses a complex mathematical control system to adjust the heating power and achieve the desired temperature.

1.2 Basic Operation of the 301 Controller

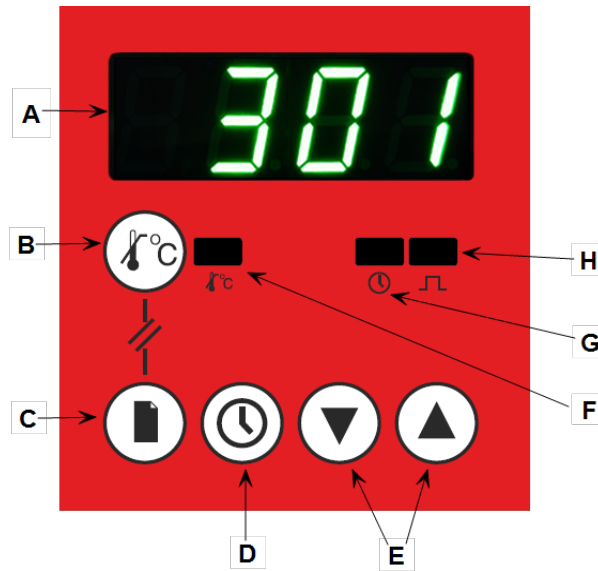

Key		Description
A	Display	
B	Over-Temperature Key (if fitted)	The Over-Temperature key is used to access the over-temperature menu. Note: Over-Temperature is an option.
C	Page Key	The Page key is used to scroll through the parameters and switch between menus.
D	Timer Key	The Timer key is used to start, view, pause and reset the timer.
E	Arrow Keys	The Arrow keys are used to adjust the value of the selected parameter and pause the output power.
F	Over-Temperature Indicator (if fitted)	The Over-Temperature indicator shows green in normal use. It flashes red when over-temperature is triggered and is constantly red when over-temperature is reset and waiting for the temperature to drop.

G	Timer Indicator	The Timer indicator shows when the timer is active.
H	Output Indicator	The Output indicator shows when the controller is switching on the heating elements.

1.2.1 Menu System

The 301 Controller is divided into two menus; the Home Menu and the Setup Menu. The Home Menu contains all the basic operating controls: setpoint, setpoint ramp rate and timer time. The Setup menu contains all the set up features: timer type, timer band, output power and customer calibration. The features available vary depending on operator input or product specification.

1.2.2 Navigation Diagram

The following diagram details how to navigate to the various menu options within the 301 Controller. At each option, values can be set using the arrow keys.

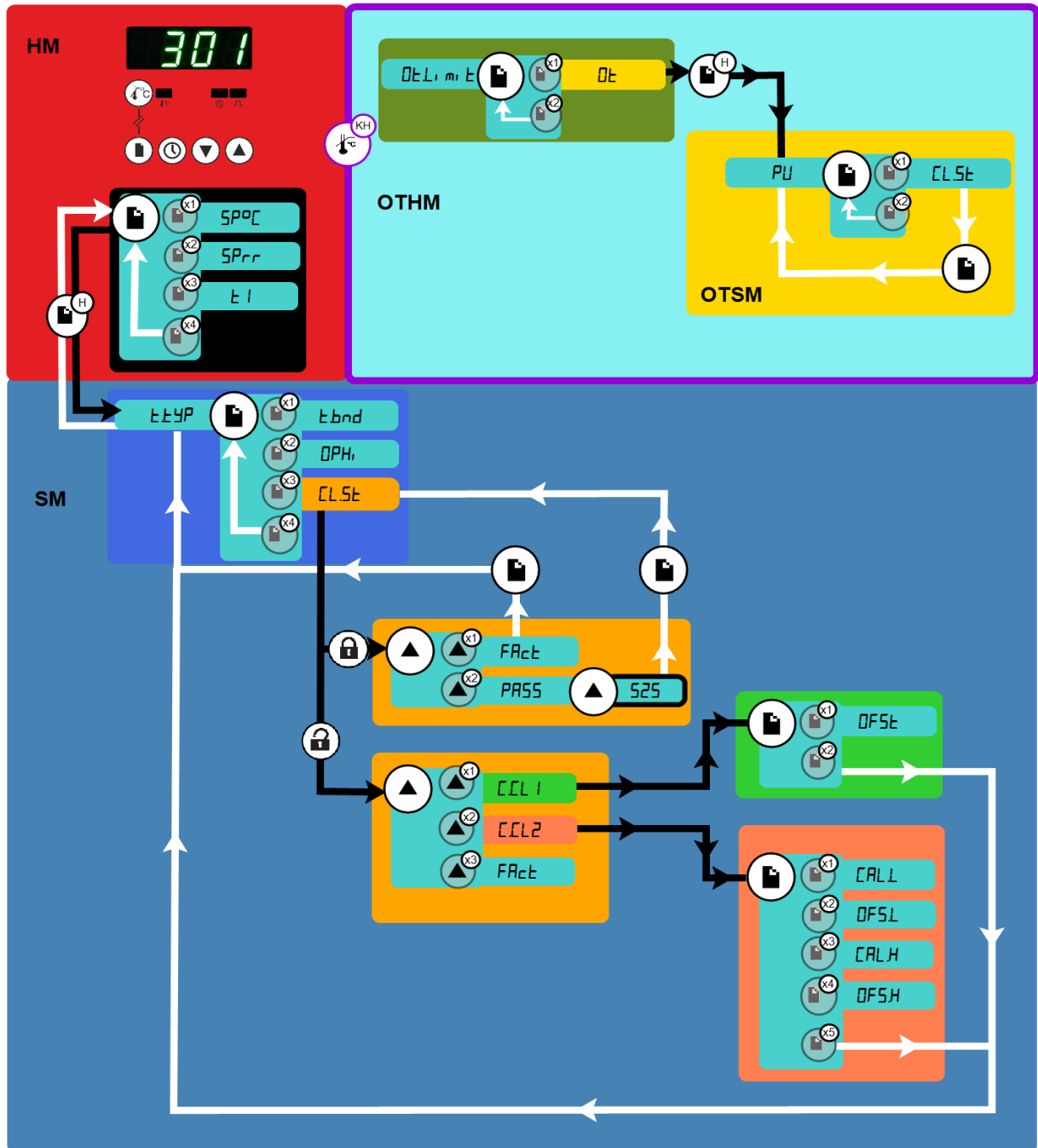

HM	Home Menu		Page Key		Black = Progress
SM	Setup Menu		Hold for 1.5 seconds		White = Return
OTHM	Over-Temperature Home Menu		Keep Held		
OTSM	Over-Temperature Setup Menu		Press Page Key multiple times		

Please note that the Over-Temperature Menu is only available when the Over-Temperature Protection option is fitted.

1.2.3 Basic Function Guide

<i>HOLD</i>	Used to pause the current program and set new parameters.
<i>SP°C</i>	Used to set the desired temperature (setpoint) of the product (°C).
<i>SPrr</i>	Used to set the heating rate of the product, e.g. increase by 5°C per minute.
<i>t1, t2, t3, t4, t5</i>	Indicates the timer type in use. See section 1.5 for more details.
<i>tYP</i>	Used to set the timer type.
<i>tband</i>	Available when <i>t1</i> or <i>t4</i> is in use. Allows the timer to start the countdown before the desired setpoint is reached.
<i>rSt</i>	Used to reset the timer.
<i>OPH_i</i>	Used to set the maximum output power.
<i>CLSt</i>	Used to set the customer calibration type.
<i>FAcSt</i>	Used to select the factory calibration settings.
<i>PASS</i>	Flashes when a password is required to access further options.
<i>CC1</i>	Select to access the single point calibration option.
<i>CC2</i>	Select to access the dual point calibration options.
<i>DFSt</i>	Used to set the single point calibration offset temperature (°C).
<i>CALL</i>	Used to set the low temperature point (°C) for dual point calibration.
<i>CALH</i>	Used to set the high temperature point (°C) for dual point calibration.
<i>DFSL</i>	Used to set the offset value for the low temperature point (°C) for dual point calibration.
<i>DFSH</i>	Used to set the offset value for the high temperature point (°C) for dual point calibration.
<i>OLt</i>	Used to set the Over-Temperature limit (°C).
<i>OLt</i>	Displayed when the Over-Temperature protection has been activated.
<i>PU</i>	Displayed before the current temperature when checking the Over-Temperature sensor temperature.

1.2.4 Home Display

The Home Display is the first display you see when the controller is switched on, it shows the actual temperature of the product. When entering the menus, the controller will automatically return to the Home Display if no keys are pressed for 30 seconds.

Finding the Home Display

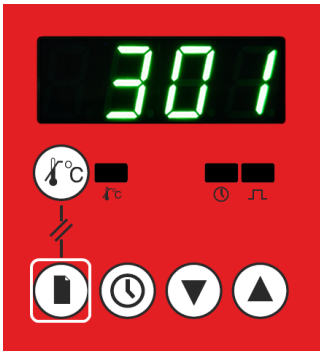

- To find the Home Display from the Home Menu, press the Page key until the current temperature is shown on the display.
- To find the Home Display from the Setup Menu, press and hold the Page key for 1.5 seconds.

1.2.5 Hold Mode

'Hold' mode turns the output off; this allows parameters to be set without the controller instantly trying to control at the new settings.

When the output indicator is off, the Home Display flashes between the current temperature and *HOLD*.

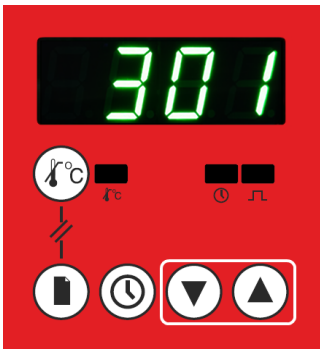

To enter 'Hold' mode:

- Start at the Home Display.
- Press and hold the up and down Arrow keys together for 1.5 seconds
- The display will flash *HOLD* to show that 'Hold' mode has been entered.

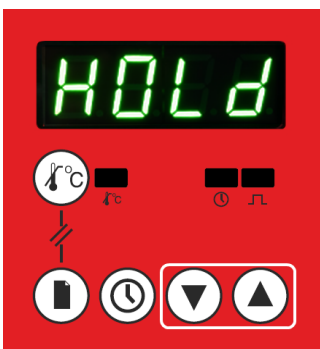

To exit 'Hold' mode:

- Start at the Home Display.
- Press and hold the up and down Arrow keys together for 1.5 seconds OR start the timer (See "The Timer").
- Note: The 'Hold' mode function is disabled when the timer function is operating.

1.2.6 Checking the Temperature Setpoint from the Home Display

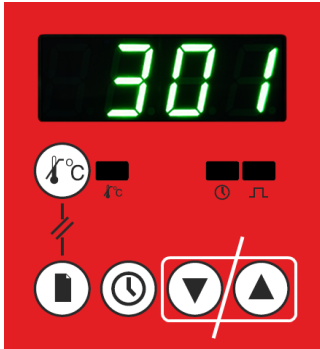

- Start at the Home Display.
- Press either the up or down Arrow key.
- The setpoint will show on the display for 3 seconds before returning to the home display.

1.2.7 Changing the Temperature Setpoint

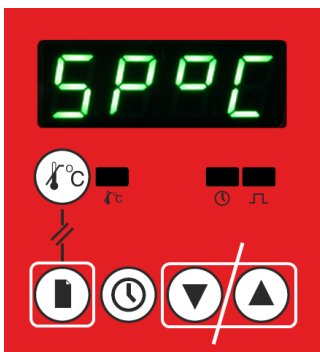

- Start at the Home Display.
- Repeatedly press the Page key to scroll through the Home Menu until SP00 is displayed.
- Use the up and down Arrow keys to alter the value.
- A single press of the up or down Arrow key shows the current setting.
- To alter this, either keep the key pressed or press it again. The value will then be stored without any further input.

1.2.8 Changing the Temperature Setpoint Ramp Rate

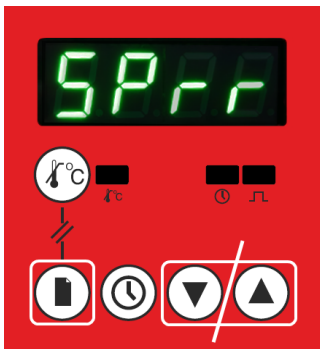

- Start at the Home Display.
- Repeatedly press the Page key to scroll through home menu until SPrr is displayed.
- Use the up and down Arrow keys to turn off or alter the value.
- A single press of either the up or down Arrow key shows the current setting. To alter, either keep pressed or press again. The value will then be stored without any further input.
- See section 1.4 for more information.

This will cause the product to heat as quickly as possible which may not be appropriate where the product contains sensitive ceramic components. For products with ceramic components, e.g. a tube furnaces fitted with a long ceramic work tube, use the ramp rate feature set with a low heating rate such as 5°C per minute (300°C per hour), to prevent damage.

1.2.9 Changing the Timer Time

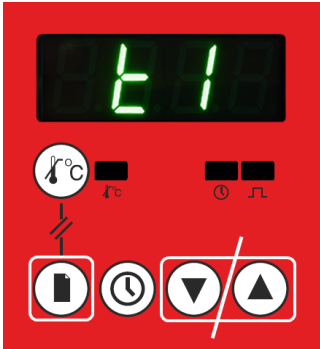

- Start at the Home Display.
- Repeatedly press the Page key to scroll through the Home Menu until $E1$, $E2$, $E3$, $E4$ or $E5$ shows on the display.
- Use the up and down Arrow keys to turn off, or alter the value.
- A single press of either the up or down Arrow key shows the current setting (Hr:Min).
- To alter this, either keep pressed or press again. The value will then be stored without any further input.
- See 1.5 for more information.

1.3 Advanced Operation

1.3.1 Entering the Setup menu

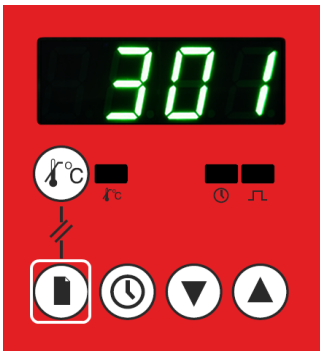

- Start at the Home Display.
- Press and hold the Page key for 1.5 seconds
- The display will change to the first parameter in the Setup Menu.

1.3.2 Changing the Timer Type

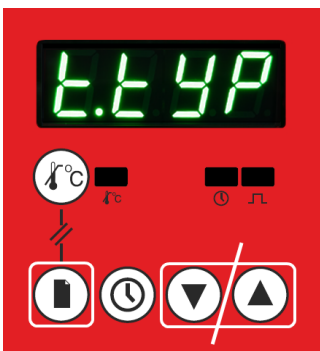

- Start at the Home Display.
- Hold the Page key for 1.5 seconds to enter the set-up menu.
- Once entered, repeatedly press the Page key until $E1YP$ is displayed.
- Use the up and down Arrow keys to alter the value.

To alter this, either keep pressed or press again. The value will then be stored without any further input. A single press of the up or down key shows the current setting.

Note: This function is disabled when the timer is operating. see section 1.5 for more information on the timer types and functions.

1.3.3 Changing the Timer Band

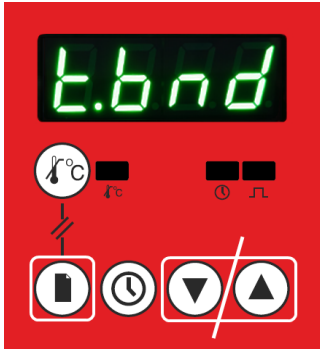

- Start at the Home Display.
- Hold the Page key for 1.5 seconds to enter the Setup Menu.
- Once entered, repeatedly press the Page key until *t.bnd* is displayed.
- Use the up and down Arrow keys to turn off or alter the value.

A single press of the up or down key shows the current setting. To alter this, either keep pressed or press again. The value will then be stored without any further input. see section 1.5 for more information .

Note: This is only available when timer type 1 or 4 is selected.

1.3.4 Changing the Maximum Output Power

Note: Output Power is a product specific setting and will not appear on all furnaces and ovens.

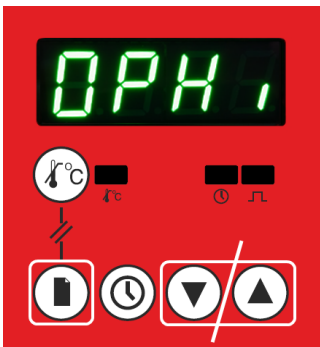

- Start at the Home Display.
- Hold the Page key for 1.5 seconds to enter the set-up menu.
- Once entered, repeatedly press the Page key until *OPH* is displayed.
- Use the up and down Arrow keys to alter the value.

A single press shows the current setting. To alter this, either keep pressed or press again. The value will then be stored without any further input.



Caution: Do not increase the power limit value to a value above the design level for the oven or furnace model, or to a value above that correctly calculated for silicon carbide elements. The heating elements could burn out, or other damage could be caused. Refer to the Fuses and Power Settings section of your product manual for more information on power limits.

1.3.5 Changing the Customer Calibration Type

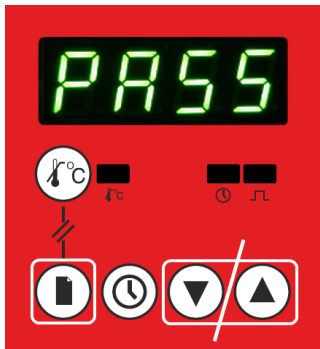
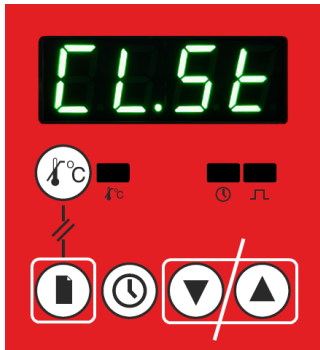

- Start at the Home Display.
- Hold page key for 1.5 seconds to enter the set-up menu.
- Once entered, repeatedly press page key until **CL5E** is displayed.
- Use the up and down Arrow keys to display the current calibration type.
- Use the up and down Arrow keys to display the password screen.
- Use the up and down Arrow keys to enter the Calibration Password (see 1.3.6).
- Press the page key to confirm password. The value will then be stored without any further input.
- See section 1.8 for more information.

1.3.6 Calibration Password

Once entered the calibration password remains active for 30 seconds after leaving the set up menu to allow time to revisit if necessary.

The Calibration Password for this instrument is: **525**

1.4 Temperature Setpoint Ramp Rate

1.4.1 Setpoint Ramp Rate

The SPrr controls the rate at which the temperature in a furnace or oven changes per minute. When SPrr has a numeric value, e.g. 5 °C/ min, the product will attempt to heat or cool at that rate. When the value of Sprr = off, the product will heat or cool as quickly as possible.

Setpoint ramp rate is useful when materials susceptible to thermal shock are being heated.

1.4.2 Limitations of Setpoint Ramp Rate

The setpoint ramp rate should not be set higher than the maximum heat up or cool down rate of the furnace or oven.

The setpoint ramp rate only resets its start position when the ramp rate is changed or the controller is taken out of 'Hold' mode.

Changes in the temperature setpoint do not affect the ramp rate.

If the temperature is set below the current temperature of the furnace or oven then after a period of time adjusted to a temperature higher than the current temperature

without adjustment of the ramp rate, the controller can become out of step and appear to switch off.

Putting the controller into, then out of 'Hold' mode will reset the ramp rate and force the controller back into control.

1.5 The Timer

1.5.1 Starting the Timer

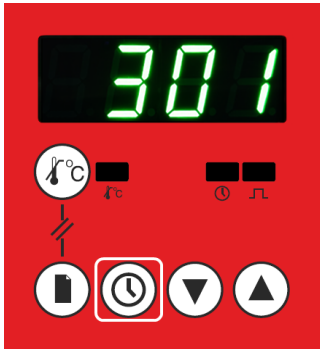

- Start at the Home Display.
- Press the Timer key once to start the timer.

If the 301 Controller is in 'Hold' mode, pressing the Timer key will automatically exit 'Hold' mode and the controller will start to operate.

1.5.2 Checking the Time Remaining

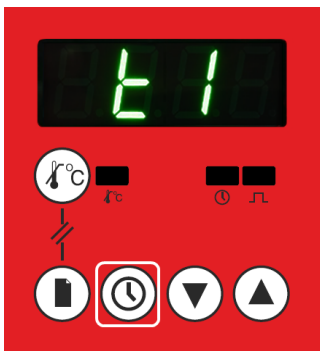

- Start at the Home Display
- Press the Timer key once to check the time remaining.
- The display will flash E1 3 times.
- It will return to the Home Display automatically.

1.5.3 Pausing the Timer

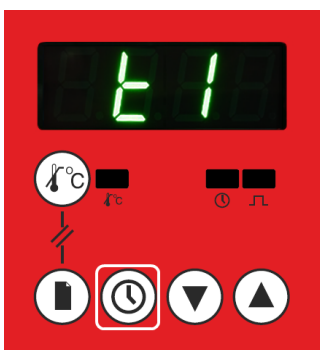

- Start at the Home Display
- Press and hold the Timer key for 1.5 seconds; the display alternately shows E1 and the current temperature.
- To resume the timer, press the Timer key once.

1.5.4 Resetting the Timer

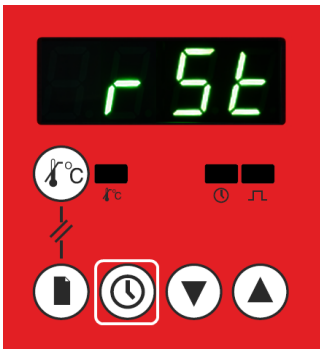

- When the timer count has ended, or the timer is paused, start at the Home Display.
- Press and hold the Timer key for 1.5 seconds.
- **r 5t** is displayed to indicate timer reset.

1.5.5 Timer Function Description

The 301 Controller has an in-built timer, which can be set to one of five types:

Timer Type t1

On pressing the Timer key; 'Timer Type 1' waits for the setpoint to be reached, then begins the countdown. On completion of the countdown, the product switches off power to the elements ('End' flashes on the display).

Timer Type t2

On pressing the Timer key; 'Timer Type 2' starts the countdown immediately. On completion of the countdown, the product switches off power to the elements ('End' flashes on the display).

Timer Type t3

On pressing the Timer key; 'Timer Type 3' immediately switches the product heating off and starts to countdown. On completion of the countdown, the furnace or oven switches on the power to the elements. This can be used to delay the start of heating.

Timer Type t4

On pressing the Timer key; 'Timer Type 4' waits for the setpoint to be reached, then begins the countdown. On completion of the countdown, the product continues to control as normal ('End' flashes on the display).

Timer Type t5

On pressing the Timer key; 'Timer Type 5' starts the countdown immediately. On completion of the countdown, the product continues to control as normal ('End' flashes on the display).

1.5.6 The Timer Temperature Band

Timer type *t1* or *t4* starts the countdown when the setpoint temperature is reached. It is possible to set the timer running before the setpoint is reached by adjustment of the timer temperature band '*tband*', e.g. '*tband*' set to a value of 3 will result in the timer starting to countdown 3°C before the temperature setpoint is reached. This is useful when furnaces or ovens that take a long time to reach setpoint, are at a sufficiently high temperature for a specific customer process to occur.

1.5.7 Timer Function Table

t.typ		On Pressing the Timer Key	During the Countdown	Completion of the Countdown
t1	Heating	ON	ON	OFF
	Timer	Starts when setpoint reached	Counts Down	OFF
	Display	Flashes t1 3 times. Shows Time remaining.	Current Temperature	Cycling Current Temperature/ End
	Timer Indicator	Flashing until setpoint reached	ON	OFF
t2	Heating	ON	ON	OFF
	Timer	Start Immediately	Counts Down	OFF
	Display	Flashes t2 3 times Shows Time remaining.	Current Temperature	Cycling Current Temperature/ End
	Timer Indicator	ON	ON	OFF
t3	Output	OFF	OFF	ON
	Timer	Starts Immediately	Counts Down	OFF
	Display	Flashes t3 3 times Shows Time remaining	Time Remaining	END shows for 3 seconds then the Current Temperature.
	Indicator	ON	ON	OFF
t4	Heating	ON	ON	ON
	Timer	Starts when setpoint reached	Counts Down	OFF
	Display	Flashes t4 3 times Shows time remaining	Current Temperature	Cycling Current Temperature/ End
	Timer Indicator	ON	ON	OFF
t5	Heating	ON	ON	ON
	Timer	Starts Immediately	Counts Down	OFF
	Display	Flashes t 3 times Shows Time remaining	Current Temperature	Cycling Current Temperature/ End
	Timer Indicator	ON	ON	OFF

1.6 Ramp Dwell Programming

The 301 Controller has the capability to follow a Ramp Dwell program.

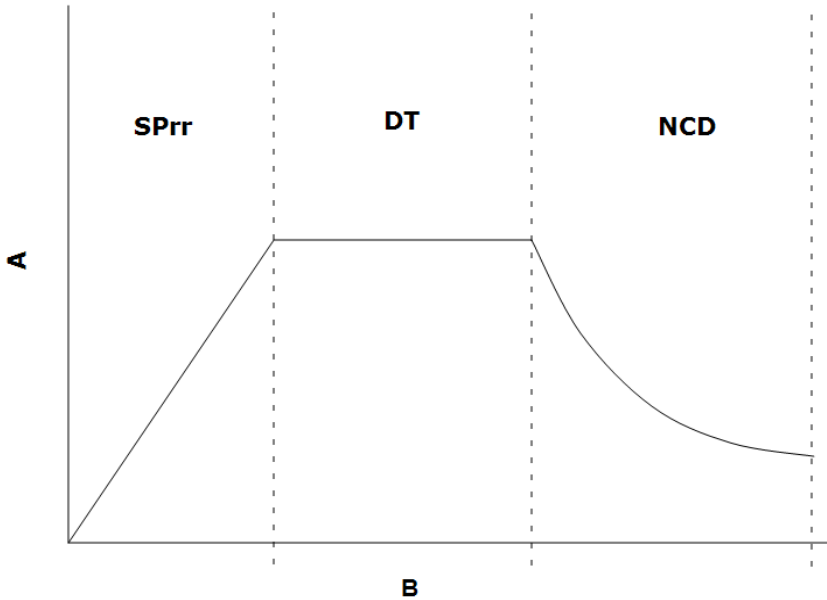

Key	
A	Temperature
B	Time
SPrr	Setpoint Ramp Rate (SPrr)
DT	Dwell Time t1
NCD	Natural Cool Down

1.6.1 Setting up a Ramp Dwell program

Set the Controller to Hold Mode:

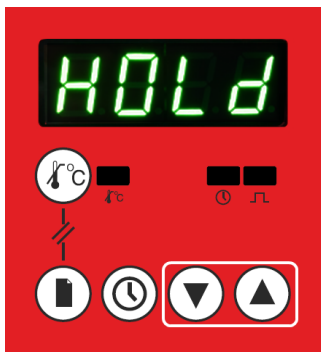

- Start at the home display
- Press and hold the up and down keys together for 1.5 seconds.
- The display will flash *HOLD* to show that 'Hold' mode has been entered.

Set the Timer Type to $t1$

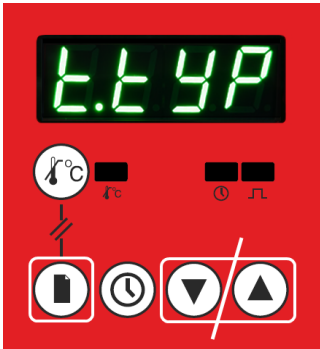

- Start at the home display
- Press and hold the Page key for 1.5 seconds to enter the Setup Menu.
- Repeatedly press the Page key until $t.tYP$ shows on the display.
- Use the up and down Arrow keys to set the value to $t1$.
- The value will then be stored without any further input.
- See the 1.5 for more information.
- Press and hold down the page key for 1.5 seconds to return to Home Menu.

Set the Temperature Setpoint

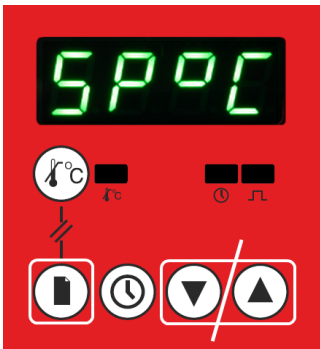

- Start at the Home Display.
- Repeatedly press the Page key until $SP0C$ shows on the display.
- Use the up and down Arrow keys to alter the value ($^{\circ}C$).
- The value will then be stored without any further input.
- Press and hold down the Page key for 1.5 seconds to return to the Home Menu.

Set the Setpoint Ramp Rate

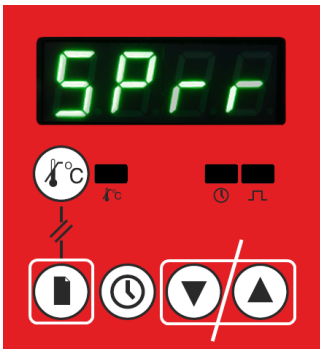

- Start at the Home Display.
- Repeatedly press the Page key until $SPrr$ shows on the display.
- Use the up and down Arrow keys to alter the value ($^{\circ}C/Min$).
- The value will then be stored without any further input.
- Press and hold down the Page key for 1.5 seconds to return to the Home Menu.

Set the Dwell Time

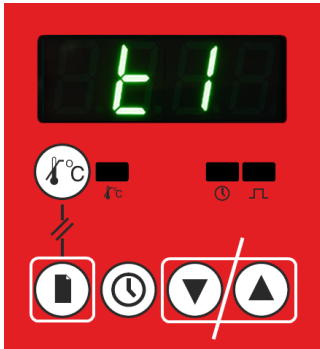

- Start at the Home Display.
- Repeatedly press the Page key until *E 1* shows on the display.
- Use the up and down Arrow keys to either switch off or alter the value (Hr:Min)
- The value will then be stored without any further input.
- Press and hold down the Page key for 1.5 seconds to return to the Home Menu.

Start the Timer

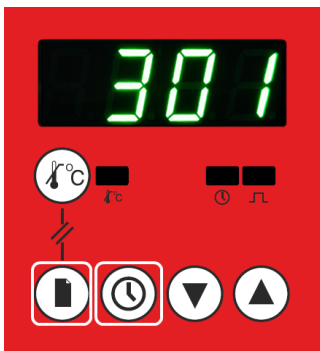

- Start at the Home Display.
- Pressing the Timer key starts the program.
- Pressing the Timer key will automatically exit 'Hold' mode if set (see section 1.2.5 for more information) and the controller will start to operate.
- Press and hold down the Page key for 1.5 seconds to return to the Home Menu.

1.7 Maximum Output Setting

Depending on the furnace or oven model the maximum output power setting OP.Hi may be accessible or hidden.

For silicon carbide heated furnaces the parameter is accessible to allow compensation for element ageing, see the Fuses and Power Settings section of your product manual for more information on power limits.

In many models the maximum output power setting depends on the supply voltage, refer to the Fuses and Power Settings section of your product manual .

1.8 Customer Calibration

The controller is calibrated for life at manufacture, there may however be sensor or other system errors which affect the accuracy of the measured temperature. Customer calibration is used to compensate for these errors. Access to this function is disabled when the timer is operating.

The 301 Controller has three types of customer calibration: factory calibration, single point calibration and dual point calibration. See sections 1.3.5 & 1.3.6 to access these.

1.8.1 Factory Calibration - *FACT*

Factory calibration is the default setting, which has no offset adjustment. It simply displays the temperature measured by the control thermocouple.

1.8.2 Single Point Calibration - $CL1$

Single point calibration uses an offset value to adjust the temperature over its whole range.

Single point calibration accurately sets the temperature for setpoint values close to the temperature at which the calibration offset is made. The accuracy is reduced for setpoint temperatures which are significantly higher or lower than the calibration offset.

Table showing examples of how to determine offset values:

Measured Calibration Temp (°C)	Displayed Temp (°C)	Old Offset Value (°C)	New Offset Adjustment	New Offset Value (°C)
252	250	0	2	2
248	250	0	-2	-2
252	250	2	2	4

The calibration temperature may be measured at the centre of the chamber or through a specially fitted port.

New Offset Value = Old Offset Value + New Offset adjustment

New Offset Adjustment = Measured Calibration Temperature – Displayed Temperature



Caution! - The procedure to determine the calibration temperature at the centre of a chamber is not covered in these instructions. If you are unsure how to do this safely, then seek advice as there is a risk of electric shock if done incorrectly.

1.8.3 Changing the Single Point Calibration Offset - $OFFSE$

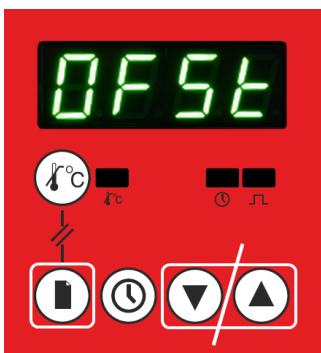

- Start at the home display.
- Hold the Page Key for 1.5 seconds to access the Setup Menu.
- Repeatedly press the Page key until $CL5E$ is displayed.
- Press the up or down Arrow keys to display the current calibration offset.
- If a password is required to access $CL1$, enter the password using the up and down Arrow keys and press the Page key to accept. You will be returned to $CL5E$.
- Use the up and down Arrow keys to scroll to $CL1$.
- Press the Page key to access $OFFSE$.
- Press the up or down Arrow keys to change the offset value.
- The value will then be stored without any further input.

Once $CL1$ has been selected as the customer calibration type, it is possible to start from the home display and go to $OFFSE$ directly, and enter the password at this point when the calibration adjustment is required again.

1.8.4 Dual Point Calibration - $CL2$

Dual point calibration uses two offset values at two corresponding temperatures to progressively change the calibration as the temperature increases or decreases. This is a more accurate representation of how the temperature difference will occur.



Caution! - Do not make **CALL** and **CALH** the same value as the controller will not work correctly and could cause the furnace or oven to overheat.

1.8.5 Changing the Calibration, Low Temperature - **CALL**

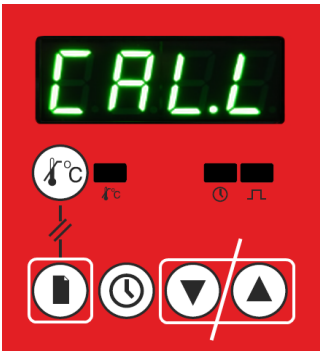

- Start at the home display.
- Hold the Page Key for 1.5 seconds to access the Setup Menu.
- Press the Page key until **CLSE** is displayed.
- Press the up or down Arrow keys to display the current calibration offset.
- If a password is required to access **CALL2**, enter the password using the up and down Arrow keys and press the Page key to accept. You will be returned to **CLSE**.
- Use the up and down Arrow keys to scroll to **CALL2**.
- Press the Page key to access **CALL**.
- Press the up or down Arrow keys to change the offset value.
- The value will then be stored without any further input.

Once **CALL2** has been selected as the customer calibration type, it is possible to start from the home display and go to **CALL** directly (or any of the other settings in **CALL2**) and enter the password at this point when calibration adjustment is required again.

1.8.6 Changing the Calibration, Low Temperature Offset - **DFSL**

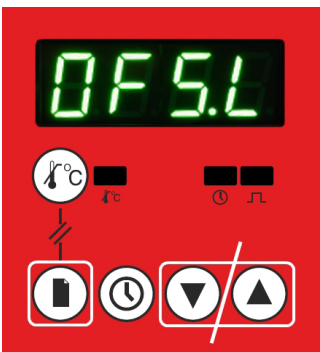

- Start at the home display.
- Hold the Page Key for 1.5 seconds to access the Setup Menu.
- Repeatedly press the Page key until **CLSE** is displayed.
- Press the up or down Arrow keys to display the current calibration offset.
- If a password is required to access **CALL2**, enter the password using the up and down Arrow keys and press the Page key to accept. You will be returned to **CLSE**.
- Use the up and down Arrow keys to scroll to **CALL2**.
- Press the Page key twice to access **DFSL**.
- Press the up or down Arrow keys to change the offset value.
- The value will then be stored without any further input.

1.8.7 Changing the Calibration, High Temperature - **CALH**



- Start at the home display.
- Hold the Page Key for 1.5 seconds to access the Setup Menu.
- Repeatedly press the Page key until **CLSE** is displayed.
- Press the up or down Arrow keys to display the current calibration offset.
- If a password is required to access **CALL2**, enter the password using the up and down Arrow keys and press the Page key to accept. You will be returned to **CLSE**.
- Use the up and down Arrow keys to scroll to **CALL2**.
- Press the Page key three times to access **CALH**.
- Press the up or down Arrow keys to change the offset value.

- The value will then be stored without any further input.

1.8.8 Changing the Calibration, High Temperature Offset - *DFSH*

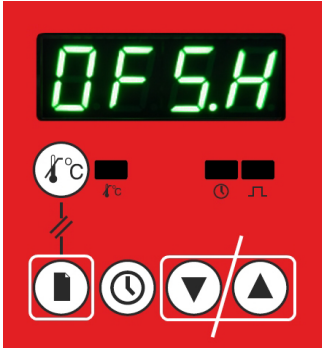

- Start at the home display.
- Hold the Page Key for 1.5 seconds to access the Setup Menu.
- Repeatedly press the Page key until *CLSE* is displayed.
- Press the up or down Arrow keys to display the current calibration offset.
- If a password is required to access *CLL2*, enter the password using the up and down Arrow keys and press the Page key to accept. You will be returned to *CLSE*.
- Use the up and down Arrow keys to scroll to *CLL2*.
- Press the Page key four times to access *DFSH*.
- Press the up or down Arrow keys to change the offset value.
- The value will then be stored without any further input.

1.9 Over-Temperature Protection

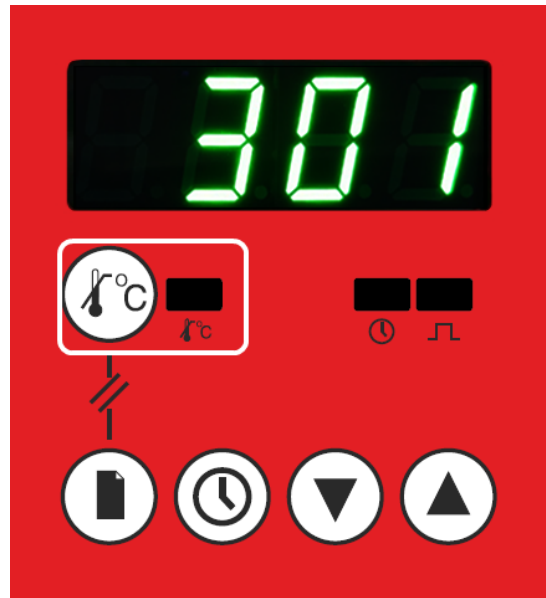

This controller may be fitted with the over-temperature protection option. If the over-temperature option is fitted the 301 display will include the Over-Temperature key and indicator (as shown in the diagram above). An independent control circuit and temperature sensor provide the over-temperature protection.

There are two uses for over-temperature protection:

1. To prevent a sample being heated in a furnace or oven from over-heating.
2. To provide an extra safety system to prevent the furnace or oven from heating in the event of a fault.

1.9.1 Over-Temperature (O/T) home display

When the Over-Temperature key is pressed and held the O/T home display is shown.

The home display shows the over-temperature limit setting.

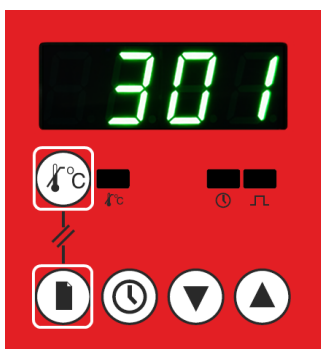

Finding the O/T home display from the O/T Home Menu:

- Press and hold the Over-Temperature key.
- Repeatedly press the Page key until the O/T limit value shows on the display.

Finding the O/T home display from the O/T Setup Menu:

- Press and hold the Over-Temperature key.
- Press and hold the Page key for 1.5 seconds.

1.9.2 Changing the Over-Temperature Limit

Note: If protection of the sample being processed is required, the over-temperature limit is normally set 15 °C above the temperature setpoint of the controller. If protection of the furnace or oven is required, the over-temperature limit is normally set 15 °C above the maximum setpoint of the furnace or oven.

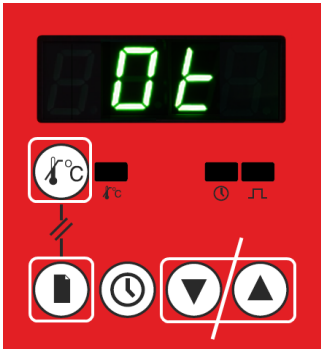

- Start at the home display.
- Press and hold the Over-Temperature key.
- Repeatedly press the Page key until **0t** shows on the display.
- Use the up and down Arrow keys to change the offset value.

A single press shows the current setting. To alter either keep pressed or press again. The value will then be stored without any further input.

1.9.3 Checking the Over-Temperature Sensor Temperature

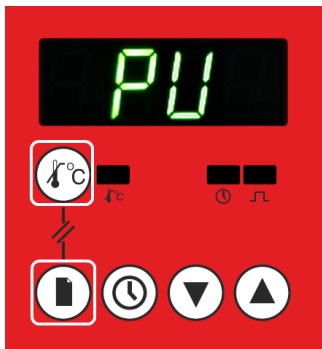

- Start at the home display.
- Press and hold the Over-Temperature key.
- Press and hold the Page key for 1.5 seconds.
- Current temperature (**PU**) is displayed for 1 second, followed by the over-temperature sensor value for 3 seconds; this sequence is then repeated.

1.9.4 Over-Temperature Protection Calibration

The over-temperature protection circuit can be calibrated in the same way as the main controller. However, this is not normally necessary as the level of accuracy required for over-temperature protection is not as critical as it is for the main control temperature.

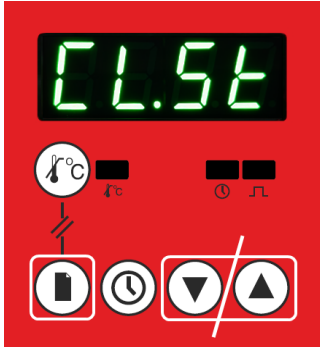

- Start at the home display.
- Press and hold the Over-Temperature key.
- Press and hold the Page key for 1.5 seconds.
- Repeatedly press the Page key until **CL.5t** is displayed.

Now follow the procedure in "Customer Calibration".

1.9.5 Over-Temperature Activation

During normal operation, the over-temperature indicator is green. If the temperature of the furnace or oven goes above the over-temperature limit, the over-temperature circuit activates. The power supply to the heating elements is switched off and the over-temperature indicator changes to flashing red.

Pressing the over-temperature key shows **OLt** in the display to indicate that the over-temperature has been triggered.

The reason for the over-temperature activation must be investigated; an incorrect setting in the over-temperature limit is may be the cause. When you are satisfied with the reason for the over-temperature activation it can be reset.

1.9.6 Resetting Over-Temperature Activation

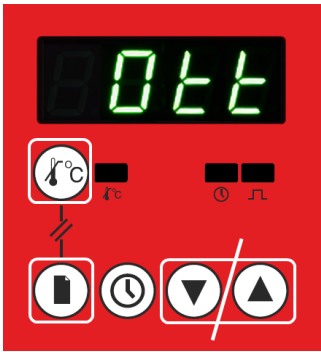

- Start at the home display.
- Press and hold the Over-Temperature key until **0tE** is displayed.
- Repeatedly press the Page key until **0tE** is displayed and the red indicator stops flashing.
- Press the up or down Arrow key to check the over-temperature limit value.
- Press the up or down Arrow key to alter the value if necessary.
- Press the Page key to return to the over-temperature display.

The over-temperature has now been reset.

If the temperature is still above the over-temperature setpoint then over-temperature indicator will be red but not flashing.

When the temperature falls below the over-temperature limit, the indicator changes back to green.

When the current temperature falls below the over-temperature setpoint, the furnace/oven starts to heat again.

1.10 RS232 Communication Option

The 301 Controller can be supplied with the capability to communicate with other devices via an RS232 link. If this option has been ordered, the furnace or oven will be supplied with a 9 pin 'D' socket for connecting to an external device. Plugging this into a computer will allow the controller to be accessed from that computer. The computer must have appropriate communication software installed such as Eurotherm's 'i-Tools'.

RS232 Communication Addressing:

- Modbus Address (Main) = 2
- Modbus Address (O/Temp) = 3
- Baud Rate = 9600
- Byte Format = 8

RS232 Communication Cables

Connecting the furnace or oven to a computer is done via a "straight" cable as follows:

Product end of cable female 9-pin	RS232 Cable: product to PC	Computer end of cable 9-pin male
Rx 3	_____	3 Tx
Tx 2	_____	2 Rx
Com 5	_____	5 Com

1.11 Temperature Controller Replacement



Before handling the controller: wear an anti-static wrist strap or otherwise avoid any possibility of damage to the unit by static electricity. Refer to the detailed instructions supplied with the replacement controller.

If the temperature controller is fitted to the back of the control panel it can be separated from the base by removal of the screws. If the temperature controller is fitted inside the product base it can be separated from the top by removal of the screws.

1.12 Glossary of Terms

Setpoint (SP)	The target temperature the furnace or oven is trying to reach.	°C
Setpoint Ramp Rate (SPrr)	The speed at which the furnace or oven is allowed to heat up or cool down	°C/ Min
Element	The heating device used in the furnace or oven.	-
Thermocouple	A thermoelectric device for measuring temperature.	-
PID	Proportional Integral Derivative: the control system used by the controller	-
Over-Temperature	The condition which a furnace or oven may enter if part of the main control circuit fails.	-
Over-Temperature Protection	A system to prevent the product or process being damaged if it has gone into an Over-Temperature condition.	-
Furnace or Oven	This refers to the product purchased from Carbolite Gero	-

1.13 Controller Fault

Fault Code Diagnostic Table

Error Code	Explanation	Actions
<i>5br</i>	Temperature sensor failure	Check all terminal connections between the temperature sensor (thermocouple) and temperature controller. It is recommended to loosen then tighten the screws in the terminal blocks in case the connections are oxidised. If this does not correct the error then replace the furnace or oven temperature sensor (thermocouple).
<i>0000</i>	Input over range	
<i>-000</i>	Input under range	
<i>E-</i> followed by numerical code	Controller Error	Turn the furnace or oven off and back on to see if this clears the error. If not contact Carbolite Gero Service – (see back cover)

Notes

Service Record

Engineer Name	Date	Record of Work

ProductLabel

The products covered in this manual are only a small part of the wide range of ovens, chamber furnaces and tube furnaces manufactured by Carbolite Gero for laboratory and industrial use. For further details of our standard or custom built products please contact us at the address below, or ask your nearest stockist.

For preventive maintenance, repair and calibration of all furnace and oven products, please contact:

Carbolite Gero Service

Telephone: + 44 (0) 1433 624242

Fax: +44 (0) 1433 624243

Email: ServiceUK@carbolite-gero.com

Carbolite Gero Ltd,

Parsons Lane, Hope, Hope Valley,
S33 6RB, England.

Telephone: + 44 (0) 1433 620011

Fax: + 44 (0) 1433 621198

Email: Info@carbolite-gero.com

www.carbolite-gero.com

CARBOLITE
GERO 30-3000°C

Copyright © 2018 Carbolite Gero Limited