

MIKRO 185

Ⓧ DE	Bedienungsanleitung	9
Ⓧ EN	Operating Manual	42
Ⓧ FR	Mode d'emploi	75
Ⓧ IT	Istruzioni per l'uso	108

Andreas Hettich GmbH & Co. KG
Föhrenstraße 12, D-78532 Tuttlingen / Germany
Phone +49 (0)7461 / 705-0
Fax +49 (0)7461 / 705-1125
info@hettichlab.com, service@hettichlab.com
www.hettichlab.com



© 2015 by Andreas Hettich GmbH & Co. KG

All rights reserved. No part of this publication may be reproduced without the prior written permission of the copyright owner.

Änderungen vorbehalten! , Modifications reserved! , Sous réserve de modifications ! , Con riserva di modifiche!

AB1203DEENFRIT / Rev. 03 / 01.18

EG-Konformitätserklärung
EC Declaration of conformity
Déclaration de conformité CE
Dichiarazione di conformità CE

des Herstellers / of the manufacturer / du fabricant / del costruttore
Andreas Hettich GmbH & Co. KG • Föhrenstraße 12 • D-78532 Tuttlingen • Germany

Hiermit erklären wir in alleiniger Verantwortung, dass das bezeichnete Gerät, inklusive dem mit dem Gerät konformitätsbewertetem Zubehör laut Zubehörliste der technischen Dokumentation dieses Geräts, der Richtlinie über In-vitro-Diagnostika 98/79/EG entspricht.

We hereby declare under our sole responsibility that the designated device and its accessories, which are listed in the technical documentation for this device and whose conformity has been assessed together with the device, conform to the Directive 98/79/EC on in vitro diagnostic medical devices.

Par la présente, nous déclarons sous notre seule responsabilité que l'appareil désigné, incluant ses accessoires attestés conformes d'après la liste des accessoires de la documentation technique du dit-appareil, répond à la directive 98/79/CE sur le diagnostic In-vitro.

Si dichiara nella nostra sola responsabilità, che l'apparecchiatura indicata, comprensiva dei conformi accessori come da elenco della documentazione tecnica di questa apparecchiatura, risponde alle direttive per Diagnostica In-Vitro 98/79/CE.

Geräteart / Type of device / Type d'appareil / Tipo di apparecchio:

Laborzentrifuge / Laboratory centrifuge / Centrifugeuse de laboratoire / Centrifuga di laboratorio

Typenbezeichnung / Type designation / Désignation du type / Denominazione del tipo:

MIKRO 185

Das Konformitätsbewertungsverfahren wurde nach Anhang III der Richtlinie 98/79/EG durchgeführt.

The conformity evaluation process was performed in accordance with appendix III of Directive 98/79/EC.

La procédure d'évaluation de la conformité a été réalisée conformément à l'annexe III de la directive 98/79/CE.

La procedura di valutazione di conformità è stata eseguita conformemente all'appendice III delle direttive 98/79/CE.

Folgende weitere europäische Richtlinien und Verordnungen wurden angewandt:

- Maschinenrichtlinie 2006/42/EG
- EMV-Richtlinie 2014/30/EU
- Niederspannungsrichtlinie 2014/35/EU
- RoHS II Richtlinie 2011/65/EU (ohne Beteiligung einer benannten Stelle)
- Verordnung (EG) Nr. 1907/2006 (REACH) (ohne Beteiligung einer benannten Stelle)

Angewandte Normen:

Gemäß Liste der angewandten Normen, die Teil der Produktakte ist.

The following additional European directives and ordinances have been applied:

- Machinery Directive 2006/42/EU
- EMC directive 2014/30/EU
- Low voltage directive 2014/35/EU
- RoHS II Directive 2011/65/EU (without involvement of a notified body)
- Ordinance (EC) No. 1907/2006 (REACH) (without involvement of a notified body)

Applied standards:

According to the list of applied standards, which is part of the product file.

Les autres directives et normes européennes suivantes ont été appliquées:

- Directive 2006/42/UE relative aux machines
- Directive CEM 2014/30/UE
- Directive basse tension 2014/35/UE
- Directive RoHS II 2011/65/UE (sans participation d'un organisme désigné)
- Directive (CE) no. 1907/2006 (REACH) (sans participation d'un organisme désigné)

Normes appliquées:

Conformément à la liste des normes appliquées relatives aux cycles du produit.

Sono state applicate le seguenti direttive e regolamenti europei:

- Direttive per macchine 2006/42/EU
- Direttive per compatibilità elettromagnetica 2014/30/EU
- Direttive per basse tensioni 2014/35/EU
- RoHS II direttive 2011/65/EU (senza concorso di un citato collaboratore)
- Regolamento (CE) n. 1907/2006 (REACH) (senza concorso di un citato collaboratore)

Norme applicate:

Conformemente alla lista delle norme applicate, che sono parte degli atti del prodotto.

Tuttlingen, 2016-07-20



Klaus-Günter Eberle
Geschäftsführer, Manager,
Directeur, Gerente



Für dieses Gerät gültige Normen und Vorschriften

Das Gerät ist ein Produkt mit einem sehr hohen technischen Niveau. Es unterliegt umfangreichen Prüf- und Zertifizierungsverfahren gemäß folgenden Normen und Vorschriften in deren jeweils gültigen Fassung:

Elektrische und mechanische Sicherheit für Konstruktion und Endprüfung:

Normbaureihe: IEC 61010 (entspricht der Normenreihe DIN EN 61010)

- IEC 61010-1 "Sicherheitsbestimmungen für elektrische Mess-, Steuer-, Regel- und Laborgeräte - Teil 1: Allgemeine Anforderungen" (Verschmutzungsgrad 2, Überspannungskategorie II)
- IEC 61010-2-010 "Sicherheitsbestimmungen für elektrische Mess-, Steuer-, Regel- und Laborgeräte – Teil 2-010: Besondere Anforderungen an Laborgeräte für das Erhitzen von Stoffen" (nur für Zentrifugen mit Heizung gültig)
- IEC 61010-2-020 "Sicherheitsbestimmungen für elektrische Mess-, Steuer-, Regel- und Laborgeräte - Teil 2-020: Besondere Anforderungen an Laborzentrifugen"
- IEC 61010-2-101 "Sicherheitsbestimmungen für elektrische Mess-, Steuer-, Regel- und Laborgeräte - Teil 2-101: Besondere Anforderungen an In-vitro-Diagnostik (IVD) Medizingeräte"

Elektromagnetische Verträglichkeit:

- EN 61326-1 "Elektrische Mess-, Steuer-, Regel- und Laborgeräte - EMV-Anforderungen - Teil 1: Allgemeine Anforderungen"

Risikomanagement:

- DIN EN ISO 14971 "Anwendung des Risikomanagements auf Medizinprodukte"

Beschränkung gefährlicher Stoffe (RoHS II):

- EN 50581 „Technische Dokumentation zur Beurteilung von Elektro- und Elektronikgeräten hinsichtlich der Beschränkung gefährlicher Stoffe“

Für Konformitätsbewertungsverfahren geltende Europäische Richtlinien:

- Richtlinie 98/79/EC über In-vitro-Diagnosegeräte
EG-Konformitätsbewertungsverfahren gemäß Anhang III "EG-Konformitätserklärung" – Eigenerklärung des Herstellers
- Richtlinie 2011/65/EU zur Beschränkung der Verwendung bestimmter gefährlicher Stoffe in Elektro- und Elektronikgeräten. Das EG-Konformitätsbewertungsverfahren erfolgt hierzu in alleiniger Verantwortung des Herstellers, ohne Beteiligung einer benannten Stelle.

Außerhalb Europas geltende Richtlinien für Medizinprodukte:

- **USA:** QSR, 21CFR 820 "CFR Title 21 - Food and Drugs: TITLE 21 - FOOD AND DRUGS, CHAPTER I - FOOD AND DRUG ADMINISTRATION DEPARTMENT OF HEALTH AND HUMAN SERVICES, SUBCHAPTER H - MEDICAL DEVICES, Part 820 QUALITY SYSTEM REGULATIONS"
- **Kanada:** CMDR, SOR/98-282 "Medical Devices Regulations"

Zertifiziertes Qualitätsmanagementsystem gemäß

- ISO 9001 "Qualitätsmanagementsysteme - Anforderungen"
- ISO13485 "Qualitätsmanagementsysteme für Medizinprodukte - Anforderungen für regulatorische Zwecke"

Umweltmanagementsystem gemäß

- ISO 14001 "Umweltmanagementsysteme - Spezifikation mit Anleitung zur Anwendung"

Standards and regulations which apply to this device

The device is a high-end technical product. It is subject to extensive testing and certification procedures according to the following standards and regulations in their respectively valid version:

Electrical and mechanical safety for design and final testing:

Standard series: IEC 61010 (conform to standards of DIN EN 61010)

- IEC 61010-1 "Safety requirements for electrical equipment for measurement, control, and laboratory use - Part 1: General requirements" (Pollution Degree 2, Excess-voltage category II)
- IEC 61010-2-010 "Safety requirements for electrical equipment for measurement, control and laboratory use - Part 2-010: Particular requirements for laboratory equipment for the heating of materials" (applied to heated centrifuges only)
- IEC 61010-2-020 "Safety requirements for electrical equipment for measurement, control, and laboratory use - Part 2-020: Particular requirements for laboratory centrifuges"
- IEC 61010-2-101 "Safety requirements for electrical equipment for measurement, control and laboratory use - Part 2-101: Particular requirements for in vitro diagnostic (IVD) medical equipment"

Electromagnetic Compatibility:

- EN 61326-1 "Electrical equipment for measurement, control and laboratory use - EMC requirements - Part 1: General requirements"

Risk management:

- DIN EN ISO 14971 "Application of risk management to medical devices"

Restriction of Hazardous Substances (RoHS II):

- EN 50581 "Technical documentation for assessing electric and electronic devices with regard to the restriction of hazardous substances"

European directives applied for conformity assessment procedures:

- In vitro diagnostic device directive 98/79/EG
EC conformity assessment procedure according to annex III "EC DECLARATION OF CONFORMITY" – self-declaration by the manufacturer
- Directive 2011/65/EU for the restriction of use of certain hazardous substances in electric and electronic devices. Carrying out the EC conformity assessment process is the sole responsibility of the manufacturer, without the involvement of a notified body.

Applied medical device regulations outside Europe:

- **USA:** QSR, 21CFR 820 "CFR Title 21 - Food and Drugs: TITLE 21- FOOD AND DRUGS, CHAPTER I - FOOD AND DRUG ADMINISTRATION DEPARTMENT OF HEALTH AND HUMAN SERVICES, SUBCHAPTER H - MEDICAL DEVICES, Part 820 QUALITY SYSTEM REGULATIONS"
- **Canada:** CMDR, SOR/98-282 "Medical Devices Regulations"

Certified quality management system according to

- ISO 9001 "Quality management systems – Requirements"
- ISO13485 "Medical devices - Quality management systems - Requirements for regulatory purposes"

Environmental management system according to

- ISO 14001 "Environmental management systems - Requirements with guidance for use"

Normes et règles en vigueur pour cet appareil

Cet appareil est un produit avec un très haut niveau technique. Il est soumis à des vastes procédures de vérification et de certification, d'après les normes et prescriptions suivantes, dans leur version actuelle :

Sécurité électrique et mécanique pour la construction et l'inspection finale :

Série de normes : IEC 61010 (correspond à la série de norme DIN EN 61010)

- IEC 61010-1 "Règles de sécurité pour appareils électriques de mesurage, de régulation et de laboratoire - partie 1 : Prescriptions générales" (niveau de saleté 2, catégorie de surtension II)
- IEC 61010-2-010 "Règles de sécurité pour appareils électriques de mesurage, de régulation et de laboratoire – partie 2-010 : Prescriptions particulières pour appareils de laboratoire utilisés pour l'échauffement des matières" (seulement valable pour centrifugeuses avec chauffage)
- IEC 61010-2-020 "Règles de sécurité pour appareils électriques de mesurage, de régulation et de laboratoire – partie 2-020 : Prescriptions particulières pour centrifugeuses de laboratoire"
- IEC 61010-2-101 "Règles de sécurité pour appareils électriques de mesurage, de régulation et de laboratoire – partie 2-101 : Prescriptions particulières pour les appareils médicaux de diagnostic in vitro" (DIV)

Compatibilité électromagnétique :

- EN 61326-1 "Matériel électrique de mesure, de commande et de laboratoire – Exigences relatives à la CEM - partie 1 : Exigences générales"

Gestion des risques :

- DIN EN ISO 14971 "Application de la gestion des risques aux dispositifs médicaux"

Restrictions relatives aux substances dangereuses (RoHS II):

- Norme européenne 50581 „Documentation technique pour l'évaluation des produits électriques et électroniques par rapport à la restriction des substances dangereuses“

Directives européennes valables pour des procédures d'évaluation de la conformité :

- directive 98/79/EC relative aux dispositifs médicaux de diagnostic in vitro
procédure d'évaluation de la conformité CE d'après l'annexe III "Déclaration CE de conformité" – déclaration spécifique du fabricant
- Directives 2011/65/UE concernant les restrictions relatives à l'utilisation de certaines substances dangereuses dans les appareils électriques et électroniques. La procédure d'évaluation de la conformité CE est sous la seule responsabilité du fabricant, sans participation d'un organisme désigné.

Directives pour dispositifs médicaux, valables en dehors de l'Europe :

- **USA** : QSR, 21CFR 820 "CFR Title 21 - Food and Drugs : TITLE 21- FOOD AND DRUGS, CHAPTER I - FOOD AND DRUG ADMINISTRATION DEPARTMENT OF HEALTH AND HUMAN SERVICES, SUBCHAPTER H - MEDICAL DEVICES, Part 820 QUALITY SYSTEM REGULATIONS"
- **Canada**: CMDR, SOR/98-282 "Medical Devices Regulations"

Système de management de la qualité certifié d'après

- ISO 9001 "Systèmes de management de la qualité - Prescriptions"
- ISO13485 "Dispositifs médicaux - Systèmes de management de la qualité - Exigences à des fins réglementaires"

Système de management environnemental d'après

- ISO 14001 "Systèmes de management environnemental - Spécification avec description pour application"

Norme e direttive valide per questo apparecchio

L'apparecchio è un dispositivo di elevatissimo livello tecnico. È sottoposto a numerosi procedimenti di collaudo e certificazione, in conformità alle seguenti norme e direttive nella corrispondente versione di validità:

Sicurezza elettrica e meccanica per la costruzione ed il collaudo finale:

Serie di norma: IEC 61010 (corrisponde alla serie di norma DIN EN 61010)

- IEC 61010-1 "Norme di sicurezza per apparecchiature elettriche di misurazione, di comando, di regolazione e di laboratorio - parte 1: Requisiti generali" (grado di imbrattamento 2, Categoria di sovratensione II)
- IEC 61010-2 -010 "Norme di sicurezza per apparecchiature elettriche di misurazione, di comando, di regolazione e di laboratorio - parte 2-010: Requisiti particolari per le apparecchiature di laboratorio per il riscaldamento di materiali" (valido solo per centrifughe con riscaldamento)
- IEC 61010-2 -020 "Norme di sicurezza per apparecchiature elettriche di misurazione, di comando, di regolazione e di laboratorio - parte 2-020: Requisiti particolari per centrifughe di laboratorio"
- IEC 61010-2 -101 "Norme di sicurezza per apparecchiature elettriche di misurazione, di comando, di regolazione e di laboratorio - parte 2-101: Requisiti particolari per la diagnostica In-vitro (IVD) apparecchiature medicali"

Compatibilità elettromagnetica:

- EN 61326-1 "Apparecchiature elettriche di misurazione, di comando, di regolazione e di laboratorio - requisiti di compatibilità elettromagnetica - parte 1: Requisiti generali"

Gestione dei rischi:

- DIN EN ISO 14971 "Applicazione della gestione dei rischi ai dispositivi medici"

Restrizione per prodotti pericolosi (RoHS II):

- EN 50581 „Documentazione tecnica per la stesura di un protocollo di valutazione delle apparecchiature elettriche ed elettroniche per quanto riguarda la restrizione per prodotti pericolosi“

Direttive europee che sono di validità per il procedimento di valutazione della conformità:

- Direttive 98/79/CE per apparecchiature di diagnosi In-vitro
Procedimento di valutazione di conformità CE conforme all'appendice III "Dichiarazione di conformità CE" – Dichiarazione propria del costruttore
- Direttive 2011/65/EU per la restrizione di impiego di particolari prodotti pericolosi nelle apparecchiature elettriche ed elettroniche. Il procedimento di valutazione della conformità CE avviene al riguardo nella sola responsabilità del costruttore, senza concorso di un citato collaboratore.

Direttive valide al di fuori dell'ambito europeo per i prodotti medicali:

- **USA:** QSR, 21CFR 820 "CFR Title 21 - Food and Drugs: TITLE 21- FOOD AND DRUGS, CHAPTER I - FOOD AND DRUG ADMINISTRATION DEPARTMENT OF HEALTH AND HUMAN SERVICES, SUBCHAPTER H - MEDICAL DEVICES, Part 820 QUALITY SYSTEM REGULATIONS"
- **Kanada:** CMDR, SOR/98-282 "Medical Devices Regulations"

Certificato sistema di gestione della qualità, conforme a

- ISO 9001 "Requisiti per sistemi di gestione qualità"
- ISO13485 "Sistemi di gestione qualità per prodotti medicali - Requisiti per impieghi di regolazione"

Sistema di gestione ambientale, conforme a

- ISO 14001 "Sistemi di gestione ambientale - Specificazione con istruzioni per l'applicazione"

Inhaltsverzeichnis

1	Anwendung dieser Bedienungsanleitung.....	11
2	Bedeutung der Symbole	11
3	Bestimmungsgemäße Verwendung.....	11
4	Restrisiken.....	11
5	Technische Daten.....	12
6	Sicherheitshinweise	13
7	Transport und Lagerung	15
7.1	Transport	15
7.2	Lagerung	15
8	Lieferumfang.....	15
9	Transportsicherung entfernen.....	16
10	Inbetriebnahme	16
11	Deckel öffnen und schließen	17
11.1	Deckel öffnen	17
11.2	Deckel schließen.....	17
12	Ein- und Ausbau des Rotors.....	17
13	Beladen des Rotors.....	18
14	Verschließen von Bio-Sicherheitssystemen	18
15	Bedien- und Anzeigeelemente	19
15.1	Angezeigte Symbole	19
15.2	Tasten des Bedienfeldes.....	19
15.3	Einstellmöglichkeiten.....	20
16	Zentrifugations-Parameter eingeben	21
16.1	Direkte Eingabe der Zentrifugations-Parameter	21
16.1.1	Drehzahl (RPM)	21
16.1.2	Relative Zentrifugalbeschleunigung (RCF) und Zentrifugerradius (RAD).....	21
16.1.3	Laufzeit	21
16.2	Eingabe der Zentrifugations-Parameter mit der Taste "SELECT"	22
17	Zentrifugation	24
17.1	Zentrifugation mit Zeitvorwahl.....	24
17.2	Dauerlauf	25
17.3	Kurzzeitzentrifugation.....	26
18	Not-Stopp	26
19	Zyklenzähler	27
20	Einstellungen und Abfragen	27
20.1	System-Informationen abfragen.....	28
20.2	Akustisches Signal.....	30
20.3	Optisches Signal nach Beendigung des Zentrifugationslaufes	31
20.4	Automatisches Entriegeln des Deckels nach dem Zentrifugationslauf.....	32
20.5	Hintergrundbeleuchtung der Anzeige.....	33
20.6	Die Betriebsstunden und die Anzahl der Zentrifugationsläufe abfragen.....	34
20.7	Zyklenzähler auf Null zurücksetzen.....	35
21	Relative Zentrifugalbeschleunigung (RCF).....	36

22	Zentrifugation von Stoffen oder Stoffgemischen mit einer höheren Dichte als $1,2 \text{ kg/dm}^3$	36
23	Notentriegelung	36
24	Pflege und Wartung	37
24.1	Zentrifuge (Gehäuse, Deckel und Schleuderraum)	37
24.1.1	Oberflächenreinigung und -pflege	37
24.1.2	Oberflächendesinfektion	37
24.1.3	Entfernen radioaktiver Verunreinigungen	37
24.2	Rotoren und Zubehör	38
24.2.1	Reinigung und Pflege	38
24.2.2	Desinfektion	38
24.2.3	Entfernen radioaktiver Verunreinigungen	38
24.2.4	Rotoren und Zubehör mit begrenzter Verwendungsdauer	38
24.3	Autoklavieren	39
24.4	ZentrifugiergefäÙe	39
25	Störungen	40
26	Netzeingangssicherungen wechseln	41
27	Rücksendung von Geräten	41
28	Entsorgung	41
29	Anhang / Appendix	141
29.1	Rotoren und Zubehör / Rotors and accessories	141

1 Anwendung dieser Bedienungsanleitung

- Vor Benutzung der Zentrifuge ist die Bedienungsanleitung zu lesen und zu beachten.
- Die Bedienungsanleitung ist Teil des Gerätes. Sie muss stets griffbereit aufbewahrt werden.
- Wird das Gerät an einem anderen Ort aufgestellt, muss die Bedienungsanleitung mitgegeben werden.

2 Bedeutung der Symbole



Symbol am Gerät:

Achtung, allgemeine Gefahrenstelle.

Vor Benutzung des Gerätes unbedingt die Bedienungsanleitung lesen und die sicherheitsrelevanten Hinweise beachten!



Symbol in diesem Dokument:

Achtung, allgemeine Gefahrenstelle.

Dieses Symbol kennzeichnet sicherheitsrelevante Hinweise und deutet auf mögliche gefährliche Situationen hin.

Das Nichtbeachten dieser Hinweise kann zu Sach- und Personenschäden führen.



Symbol am Gerät und in diesem Dokument:

Warnung vor Biogefährdung.



Symbol in diesem Dokument:

Dieses Symbol deutet auf wichtige Sachverhalte hin.



Symbol am Gerät und in diesem Dokument:

Symbol für die getrennte Sammlung von Elektro- und Elektronikgeräten, gemäß der Richtlinie 2002/96/EG (WEEE). Das Gerät gehört zur Gruppe 8 (Medizinische Geräte).

Verwendung in den Ländern der Europäischen Union sowie in Norwegen und der Schweiz.

3 Bestimmungsgemäße Verwendung

Bei dem vorliegenden Gerät handelt es sich um ein Medizinprodukt (Laborzentrifuge) im Sinne der IVD-Richtlinie 98/79/EG.

Die Zentrifuge dient zum Trennen von Stoffen bzw. Stoffgemischen mit einer Dichte von max. 1,2 kg/dm³.

Darunter fallen Probenvorbereitungen für molekularbiologische Untersuchungen im klinischen Bereich. Die Zentrifugation ist dabei ein entscheidender Schritt bei der Extraktion und Reinigung von DNA und RNA aus Patientenproben. Dazu werden in der Routine vielfach spezielle Kits verwendet. Kommen Kits mit Spin columns zum Einsatz, erfüllt die Zentrifuge mit einer ausreichend hohen Zentrifugalbeschleunigung und ihrem speziell für die Zentrifugation von Spin column-Kits konzipierten Rotor die Anforderungen der Probenvorbereitung in der Infektionsdiagnostik.

Die Zentrifuge ist nur für diesen Verwendungszweck bestimmt.

Eine andere oder darüber hinausgehende Benutzung gilt als nicht bestimmungsgemäß. Für hieraus entstehende Schäden haftet die Firma Andreas Hettich GmbH & Co. KG nicht.

Zur bestimmungsgemäßen Verwendung gehört auch das Beachten aller Hinweise aus der Bedienungsanleitung und die Einhaltung der Inspektions- und Wartungsarbeiten.

Wird die Zentrifuge in ein anderes Gerät eingebaut oder in ein System integriert, so ist der Hersteller des Gesamtsystems für dessen Sicherheit verantwortlich.

4 Restrisiken

Das Gerät ist nach dem Stand der Technik und den anerkannten sicherheitstechnischen Regeln gebaut. Bei unsachgemäßer Verwendung und Behandlung können Gefahren für Leib und Leben des Benutzers oder Dritter bzw. Beeinträchtigungen an dem Gerät oder an anderen Sachwerten entstehen. Das Gerät ist nur für die bestimmungsgemäße Verwendung, und nur in sicherheitstechnisch einwandfreiem Zustand zu benutzen.

Störungen, die die Sicherheit beeinträchtigen können, sind umgehend zu beseitigen.

5 Technische Daten

Hersteller	Andreas Hettich GmbH & Co. KG D-78532 Tuttlingen	
Modell	MIKRO 185	
Typ	1203	1203-01
Netzspannung ($\pm 10\%$)	200 - 240 V 1~	100 - 127 V 1~
Netzfrequenz	50 - 60 Hz	50 - 60 Hz
Anschlusswert	390 VA	390 VA
Stromaufnahme	1.8 A	3.6 A
Kapazität max.	24 x 1.5 / 2.0 ml	
zulässige Dichte	1.2 kg/dm ³	
Drehzahl (RPM)	14000	
Beschleunigung (RCF)	18845	
Kinetische Energie	2450 Nm	
Prüfpflicht (BGR 500)	nein	
Umgebungsbedingungen (EN / IEC 61010-1)	<p>nur in Innenräumen bis zu 2000 m über Normal-Null 2°C bis 40°C maximale relative Luftfeuchte 80% für Temperaturen bis 31°C, linear abnehmend bis 50% relativer Luftfeuchte bei 40°C.</p>	
– Aufstellungsort		
– Höhe		
– Umgebungstemperatur		
– Luftfeuchtigkeit		
– Überspannungskategorie (IEC 60364-4-443)	II	
– Verschmutzungsgrad	2	
Geräteschutzklasse	I	
nicht für den Einsatz in explosionsgefährdeter Umgebung geeignet.		
EMV		
– Störaussendung, Störfestigkeit	EN / IEC 61326-1, Klasse B	FCC Class B
Geräuschpegel (rotorabhängig)	≤ 59 dB(A)	
Abmessungen		
– Breite	261 mm	
– Tiefe	353 mm	
– Höhe	228 mm	
Gewicht	ca. 11 kg	

6 Sicherheitshinweise



Werden nicht alle Hinweise in dieser Bedienungsanleitung befolgt, kann beim Hersteller kein Gewährleistungsanspruch geltend gemacht werden.



- Die Zentrifuge ist so aufzustellen, dass sie standsicher betrieben werden kann.
- Vor Benutzung der Zentrifuge unbedingt den Rotor auf festen Sitz prüfen.
- Während eines Zentrifugationslaufes dürfen sich gemäß EN / IEC 61010-2-020, in einem Sicherheitsbereich von 300 mm um die Zentrifuge herum, keine Personen, Gefahrstoffe und Gegenstände befinden.
- Rotoren, Gehänge und Zubehörteile, die starke Korrosionsspuren oder mechanische Schäden aufweisen, oder deren Verwendungsdauer abgelaufen ist, dürfen nicht mehr verwendet werden.
- Die Zentrifuge darf nicht mehr in Betrieb genommen werden, wenn der Schleuderraum sicherheitsrelevante Schäden aufweist.
- Bei Zentrifugen ohne Temperaturregelung kann es bei erhöhter Raumtemperatur und/oder bei häufigem Gebrauch des Gerätes zur Erwärmung des Schleuderraums kommen. Eine temperaturbedingte Veränderung des Probenmaterials kann deshalb nicht ausgeschlossen werden.

- **Vor Inbetriebnahme der Zentrifuge ist die Bedienungsanleitung zu lesen und zu beachten. Nur Personen, die die Bedienungsanleitung gelesen und verstanden haben, dürfen das Gerät bedienen.**
- Neben der Bedienungsanleitung und den verbindlichen Regelungen der Unfallverhütung sind auch die anerkannten fachtechnischen Regeln für sicherheits- und fachgerechtes Arbeiten zu beachten. Die Bedienungsanleitung ist um Anweisungen aufgrund bestehender nationaler Vorschriften des Verwenderlandes zur Unfallverhütung und zum Umweltschutz zu ergänzen.
- Die Zentrifuge ist nach dem Stand der Technik gebaut und betriebssicher. Es können aber von ihr Gefahren für den Benutzer oder Dritte ausgehen, wenn sie nicht von geschultem Personal oder unsachgemäß oder zu nicht bestimmungsgemäßem Gebrauch eingesetzt wird.
- Die Zentrifuge darf während des Betriebs nicht bewegt oder angestoßen werden.
- Im Störfall bzw. bei der Notentriegelung nie in den sich drehenden Rotor greifen.
- Um Schäden durch Kondensat zu vermeiden, muss bei Wechsel von einem kalten in einen warmen Raum, die Zentrifuge entweder mindestens 3 Stunden im warmen Raum aufwärmen bevor sie an das Netz angeschlossen werden darf oder 30 Minuten im kalten Raum warmlaufen.
- Es dürfen nur die vom Hersteller für dieses Gerät zugelassenen Rotoren und das zugelassene Zubehör verwendet werden (siehe Kapitel "Anhang/Appendix, Rotoren und Zubehör/Rotors and accessories"). Bevor Zentrifugiergefäße verwendet werden, die nicht in Kapitel "Anhang/Appendix, Rotoren und Zubehör/Rotors and accessories" aufgeführt sind, hat sich der Benutzer beim Hersteller zu vergewissern, ob diese verwendet werden dürfen.
- Der Rotor der Zentrifuge darf nur entsprechend dem Kapitel "Beladen des Rotors" beladen werden.
- Bei der Zentrifugation mit maximaler Drehzahl darf die Dichte der Stoffe oder Stoffgemische $1,2 \text{ kg/dm}^3$ nicht überschreiten.
- Zentrifugationen mit unzulässiger Unwucht sind nicht erlaubt.
- Die Zentrifuge darf nicht in explosionsgefährdeter Umgebung betrieben werden.
- Eine Zentrifugation mit:
 - brennbaren oder explosiven Materialien
 - Materialien, die chemisch mit hoher Energie miteinander reagieren ist verboten.

- Bei der Zentrifugation von gefährlichen Stoffen bzw. Stoffgemischen, die toxisch, radioaktiv oder mit pathogenen Mikroorganismen verseucht sind, sind durch den Benutzer geeignete Maßnahmen zu treffen.
Es müssen grundsätzlich Zentrifugiergefäße mit speziellen Schraubverschlüssen für gefährliche Substanzen verwendet werden. Bei Materialien der Risikogruppe 3 und 4 ist zusätzlich zu den verschließbaren Zentrifugiergefäßen ein Bio-Sicherheitssystem zu verwenden (siehe Handbuch "Laboratory Bio-safety Manual" der Weltgesundheitsorganisation).
Bei einem Bio-Sicherheitssystem verhindert eine Bioabdichtung (Dichtring) das Austreten von Tröpfchen und Aerosolen.
Beschädigte Dichtringe dürfen nicht mehr zum Abdichten des Bio-Sicherheitssystems verwendet werden.
Ohne Verwendung eines Bio-Sicherheitssystems ist eine Zentrifuge im Sinne der Norm EN / IEC 61010-2-020 nicht mikrobiologisch dicht.
Beim Verschließen eines Bio-Sicherheitssystems sind die Anweisungen in Kapitel "Bio-Sicherheitssysteme verschließen" zu befolgen.
Lieferbare Bio-Sicherheitssysteme siehe Kapitel "Anhang/Appendix, Rotoren und Zubehör/Rotors and accessories". Im Zweifelsfall sind entsprechende Informationen beim Hersteller einzuholen.
- Der Betrieb der Zentrifuge mit stark korrodierenden Stoffen, welche die mechanische Festigkeit von Rotoren, Gehäusen und Zubehörteilen beeinträchtigen können, ist nicht erlaubt.
- Reparaturen dürfen nur von einer vom Hersteller autorisierten Person ausgeführt werden.
- Es dürfen nur Originalersatzteile und zugelassenes Originalzubehör der Firma Andreas Hettich GmbH & Co. KG verwendet werden.
- Es gelten die folgenden Sicherheitsbestimmungen:
EN / IEC 61010-1 und EN / IEC 61010-2-020 sowie deren nationalen Abweichungen.
- Die Sicherheit und Zuverlässigkeit der Zentrifuge ist nur dann gewährleistet, wenn:
 - die Zentrifuge nach der Bedienungsanleitung betrieben wird.
 - die elektrische Installation, am Aufstellungsort der Zentrifuge, den Anforderungen von EN / IEC Festlegungen entspricht.
 - die in den jeweiligen Ländern vorgeschriebenen Prüfungen für die Sicherheit des Gerätes, z. B. in Deutschland nach BGV A1 und BGR 500, durch einen Sachkundigen durchgeführt werden.

7 Transport und Lagerung

7.1 Transport



Die Transportsicherung muss, vor dem Transport des Gerätes, eingebaut werden.

Beim Transport des Gerätes und des Zubehörs müssen folgende Umgebungsbedingungen eingehalten werden:

- Umgebungstemperatur: -20°C bis $+60^{\circ}\text{C}$
- Relative Luftfeuchtigkeit: 20% bis 80%, nicht kondensierend

7.2 Lagerung



Das Gerät und das Zubehör dürfen nur in geschlossenen und trockenen Räumen gelagert werden.

Bei der Lagerung des Gerätes und des Zubehörs müssen folgende Umgebungsbedingungen eingehalten werden:

- Umgebungstemperatur: -20°C bis $+60^{\circ}\text{C}$
- Relative Luftfeuchtigkeit: 20% bis 80%, nicht kondensierend

8 Lieferumfang

Folgendes Zubehör wird mit der Zentrifuge geliefert:

- 1 Netzkabel
- 2 Sicherungen
- 1 Sechskant-Stiftschlüssel
- 1 Bedienungsanleitung
- 1 Hinweisblatt Transportsicherung
- 1 Hinweisblatt Notentriegelung

Rotor(en) und das entsprechende Zubehör werden je nach Bestellung mitgeliefert.

9 Transportsicherung entfernen



Die Transportsicherung muss unbedingt entfernt werden.

Die Transportsicherung aufbewahren, da sie vor dem Transport des Gerätes, wieder eingebaut werden muss.

Das Gerät darf nur mit eingebauter Transportsicherung transportiert werden.

Um das Gerät während des Transports vor Beschädigungen zu schützen, wird der Motor fixiert. Diese Transportsicherung muss bei der Inbetriebnahme des Gerätes entfernt werden.

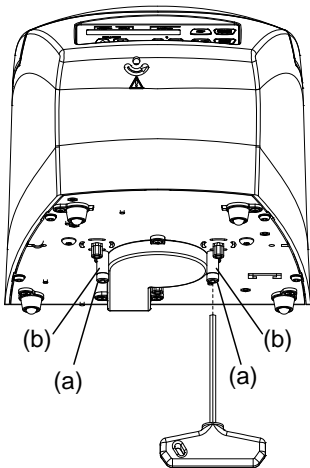

- Die beiden Schrauben (a) und Abstandshülsen (b) entfernen.



Der Einbau der Transportsicherung erfolgt in umgekehrter Reihenfolge.

10 Inbetriebnahme

- Die Transportsicherung am Gehäuseboden entfernen, siehe Kapitel "Transportsicherung entfernen".
- **Die Zentrifuge an einem geeigneten Platz standsicher aufstellen und nivellieren. Bei der Aufstellung ist der geforderte Sicherheitsbereich gemäß EN / IEC 61010-2-020, von 300 mm um die Zentrifuge herum, einzuhalten.**



Während eines Zentrifugationslaufes dürfen sich gemäß EN / IEC 61010-2-020, in einem Sicherheitsbereich von 300 mm um die Zentrifuge herum, keine Personen, Gefahrstoffe und Gegenstände befinden.

- Lüftungsöffnungen dürfen nicht zugestellt werden.
Es muss ein Abstand von 300 mm zu den Lüftungsschlitzen und Lüftungsöffnungen der Zentrifuge eingehalten werden.
- Prüfen, ob die Netzspannung mit der Angabe auf dem Typenschild übereinstimmt.
- Die Zentrifuge mit dem Netzkabel an eine genormte Netzsteckdose anschließen. Anschlusswert siehe Kapitel "Technische Daten".
- Den Netzschalter einschalten (Schalterstellung "I").
Nacheinander erscheinen folgende Anzeigen:
 1. das Zentrifugen-Modell
 2. die Typ-Nummer und die Programmversion
 3. die zuletzt benutzten Zentrifugations-Daten



Wenn der Deckel geschlossen ist, wird die Meldung "Open the lid" angezeigt.
In diesem Fall den Deckel öffnen, damit die Zentrifugations-Daten angezeigt werden.

11 Deckel öffnen und schließen

11.1 Deckel öffnen

 Der Deckel lässt sich nur öffnen, wenn die Zentrifuge eingeschaltet ist und der Rotor stillsteht. Sollte dies nicht möglich sein, siehe Kapitel "Notentriegelung".

 Wenn der Zyklenzähler aktiviert ist, wird nach einem Zentrifugationslauf, während dem Öffnen des Deckels, kurzzeitig die verbleibende Anzahl der Laufzyklen (Zentrifugationsläufe) angezeigt.

Beispiel:

>RCF<	RPM	t/min:s
RemCycles= 16703		





- Taste drücken.
Der Deckel entriegelt motorisch.
 : Deckel entriegelt.

Beispiel:

>RCF<	RPM	t/min:s
	4500	5:00

11.2 Deckel schließen

 Mit den Fingern nicht zwischen Deckel und Gehäuse greifen.
Den Deckel nicht zuschlagen.

- Den Deckel auflegen und die Deckelvorderkante leicht niederdrücken.
Der Deckel verriegelt motorisch.
 : Deckel verriegelt.

Beispiel:

>RCF<	RPM	t/min:s
	4500	5:00

12 Ein- und Ausbau des Rotors

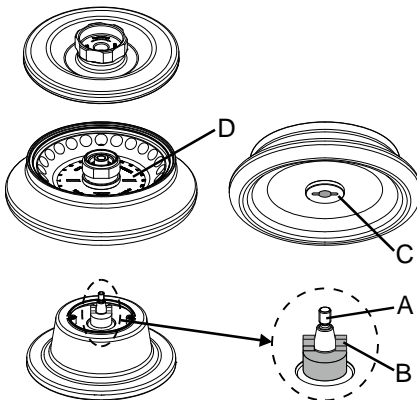

Einbau:

- Die Motorwelle (A) und die Bohrung des Rotors reinigen und anschließend die Motorwelle leicht einfetten. Schmutzpartikel zwischen der Motorwelle und dem Rotor verhindern einen einwandfreien Sitz des Rotors und verursachen einen unruhigen Lauf.
- Den Rotor vertikal auf die Motorwelle aufsetzen. Der Mitnehmer (B) an der Motorwelle muss sich in der Nut (C) des Rotors befinden. Auf dem Rotor ist die Ausrichtung der Nut gekennzeichnet (D).
- Die Spannmutter des Rotors mit dem mitgelieferten Sechskant-Stiftschlüssel durch Drehen im Uhrzeigersinn anziehen.
- Den Rotor auf festen Sitz prüfen.

Ausbau:

- Mit dem mitgelieferten Sechskant-Stiftschlüssel die Spannmutter des Rotors durch Drehen entgegen dem Uhrzeigersinn lösen und bis zum Abhebe-Druckpunkt drehen. Nach Überwindung des Abhebe-Druckpunkts löst sich der Rotor vom Konus der Motorwelle. Die Spannmutter drehen, bis sich der Rotor von der Motorwelle abheben lässt.
- Den Rotor von der Motorwelle abheben.

13 Beladen des Rotors



Standard-ZentrifugiergefäÙe aus Glas sind belastbar bis RZB 4000 (DIN 58970 Teil 2).

- Den Rotor auf festen Sitz prüfen.
- Die Rotoren dürfen nur symmetrisch beladen werden. Die ZentrifugiergefäÙe müssen gleichmäÙig auf alle Plätze des Rotors verteilt werden. Zugelassene Kombinationen siehe Kapitel "Anhang/Appendix, Rotoren und Zubehör/Rotors and accessories".

Beispiel:

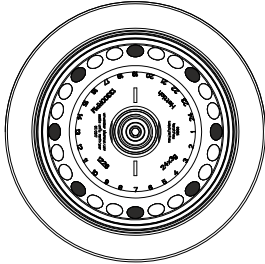

Rotor ist gleichmäÙig beladen

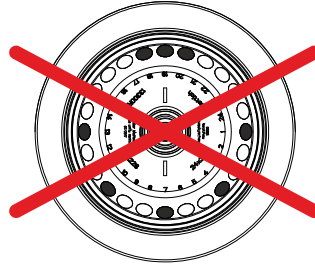

Nicht zulässig!
Rotor ist ungleichmäÙig beladen

- Die ZentrifugiergefäÙe dürfen nur außerhalb der Zentrifuge befüllt werden.
- Die vom Hersteller angegebene maximale Füllmenge der ZentrifugiergefäÙe darf nicht überschritten werden.

Die ZentrifugiergefäÙe dürfen nur soweit befüllt werden, dass während des Zentrifugationslaufes keine Flüssigkeit aus den GefäÙen herausgeschleudert werden kann.

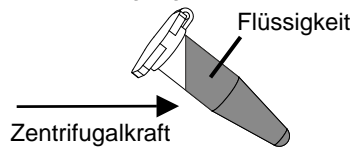

- Beim Beladen des Rotors darf keine Flüssigkeit in den Rotor und in den Schleuderraum gelangen.
- Um die Gewichtsunterschiede innerhalb der ZentrifugiergefäÙe möglichst gering zu halten, ist auf eine gleichmäÙige Füllhöhe in den GefäÙen zu achten.
- Auf jedem Rotor ist das Gewicht der zulässigen Füllmenge angegeben. Dieses Gewicht darf nicht überschritten werden.

14 Verschließen von Bio-Sicherheitssystemen



Um Dichtigkeit zu gewährleisten, muss der Deckel eines Bio-Sicherheitssystems fest verschlossen werden.

Um ein Verdrehen des Dichtungsringes während dem Öffnen und Schließen des Deckels zu vermeiden, muss der Dichtungsring mit Talkum-Puder oder einem Gummi-Pflegemittel leicht eingerieben werden.

Lieferbare Bio-Sicherheitssysteme siehe Kapitel "Anhang/Appendix, Rotoren und Zubehör/Rotors and accessories". Im Zweifelsfall sind entsprechende Informationen beim Hersteller einzuholen.

Deckel mit Schraubverschluss und Drehgriff

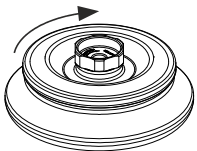

- Den Deckel mittig auf den Rotor aufsetzen.
- Den Deckel von Hand, durch Drehen des Drehgriffs im Uhrzeigersinn, fest verschließen.

15 Bedien- und Anzeigeelemente

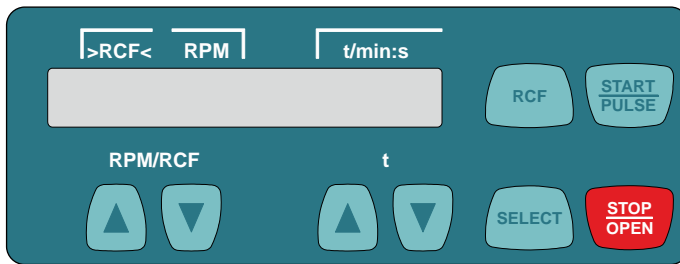

15.1 Angezeigte Symbole



Deckel entriegelt.



Deckel verriegelt.



Rotationsanzeige. Die Rotationsanzeige leuchtet rotierend gegen den Uhrzeigersinn auf, solange sich der Rotor dreht.

15.2 Tasten des Bedienfeldes

RPM/RCF



- Die Drehzahl direkt eingeben.
- Bei Gedrückthalten der Taste ändert sich der Wert mit zunehmender Geschwindigkeit.

t



- Die Laufzeit direkt eingeben. Einstellbar bis 1 Minute in 1 Sekunden-Schritten und ab 1 Minute in 1 Minuten-Schritten.
- Die Zentrifugations-Parameter eingeben.
- Bei Gedrückthalten der Taste ändert sich der Wert mit zunehmender Geschwindigkeit.



- Wähltaste zum Anwählen der einzelnen Parameter. Durch jeden weiteren Tastendruck wird der nachfolgende Parameter angewählt.
- Das "MACHINE MENU" aufrufen (die Taste 8 Sekunden gedrückt halten).
- Im "Machine Menu" die Menüs Info , Settings und Time \& Cycles auswählen.
- In den Menüs vorwärts blättern.



- Umschalten zwischen RPM-Anzeige (RPM) und RCF-Anzeige (RCF). RCF-Werte werden in Klammern RCF angezeigt.
- RPM : Drehzahl
- RCF : Relative Zentrifugalbeschleunigung



- Den Zentrifugationslauf starten.
- Kurzzeitzentrifugation. Der Zentrifugationslauf erfolgt, solange die Taste gedrückt gehalten wird.
- Die Menüs Info , Settings und Time \& Cycles aufrufen.



- Den Zentrifugationslauf beenden. Der Rotor läuft mit vorgewählter Bremsstufe aus. Zweimaliges Drücken der Taste löst den Not-Stopp aus.
- Den Deckel entriegeln.

15.3 Einstellmöglichkeiten

t/min **Laufzeit.** Einstellbar von 1 - 99 min, in 1 Minuten-Schritten.

t/sec **Laufzeit.** Einstellbar von 1 - 59 s, in 1 Sekunden-Schritten.

Dauerlauf "--:--". Parameter **t/min** und **t/sec** auf Null stellen.

RPM **Drehzahl**

Einstellbar ist ein Zahlenwert von 200 RPM bis zur maximalen Drehzahl des Rotors.
Einstellbar von 200 RPM bis 10000 RPM in 10er Schritten und über 10000 RPM in 100er Schritten.
Maximale Drehzahl des Rotors siehe Kapitel "Anhang/Appendix, Rotoren und Zubehör/Rotors and accessories".

▷RCF◁ **Relative Zentrifugalbeschleunigung**

Einstellbar ist ein Zahlenwert, der eine Drehzahl zwischen 200 RPM und der maximalen Drehzahl des Rotors ergibt.

Einstellbar bis 10000 in 1er Schritten und über 10000 in 10er Schritten.



Die Eingabe der relativen Zentrifugalbeschleunigung (RCF) ist nur möglich, wenn die RCF-Anzeige (▷RCF◁) angewählt ist.

Die relative Zentrifugalbeschleunigung (RCF) ist vom Zentrifugerradius (RAD) abhängig. Nach der Eingabe der RCF überprüfen, dass der korrekte Zentrifugerradius eingestellt ist.

RAD/mm **Zentrifugerradius**

Einstellbar von 10 mm bis 250 mm, in 1 Millimeter-Schritten.

Zentrifugerradius siehe Kapitel "Anhang/Appendix, Rotoren und Zubehör/Rotors and accessories".





Die Eingabe des Zentrifugerradius ist nur möglich, wenn die RCF-Anzeige (▷RCF◁) angewählt ist.

↵_DEC **Bremsstufe.** **fast** = kurze Auslaufzeit, **slow** = lange Auslaufzeit.

16 Zentrifugations-Parameter eingeben

16.1 Direkte Eingabe der Zentrifugations-Parameter

Die Drehzahl (RPM), die relative Zentrifugalbeschleunigung (RCF), der Zentrifugerradius (RAD) und die Laufzeit

können direkt mit den Tasten   eingegeben werden, ohne dass zuvor die Taste  gedrückt werden muss.

 Die eingestellten Zentrifugations-Parameter werden erst nach Start des Zentrifugationslaufes gespeichert.

16.1.1 Drehzahl (RPM)



- Bei Bedarf die Taste drücken, um die RPM-Anzeige (RPM) anzuwählen.



- Mit den Tasten den gewünschten Wert einstellen.

Beispiel:

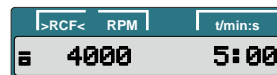
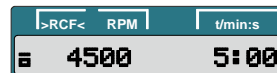

16.1.2 Relative Zentrifugalbeschleunigung (RCF) und Zentrifugerradius (RAD)



- Bei Bedarf die Taste drücken, um die RCF-Anzeige (>RCF<) anzuwählen.



- Mit den Tasten den gewünschten RCF-Wert einstellen.

Beispiel:

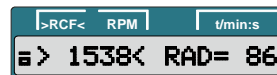
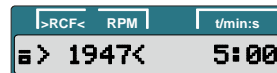

- Bei Bedarf mit den Tasten den gewünschten Zentrifugerradius einstellen.

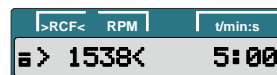
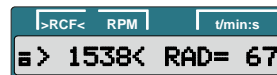

16.1.3 Laufzeit

 Die Laufzeit kann bis 1 Minute in 1 Sekunden-Schritten und ab 1 Minute nur in 1 Minuten-Schritten eingestellt werden.

Um den Dauerlauf einzustellen müssen die Parameter **t/min** und **t/sec** auf Null gestellt werden. In der Zeit-Anzeige (t/min:s) erscheint "--:--".

Beispiel:

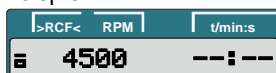

Beispiel:



- Mit den Tasten den gewünschten Wert einstellen.



16.2 Eingabe der Zentrifugations-Parameter mit der Taste "SELECT"



Die Laufzeit kann in Minuten und Sekunden eingestellt werden (Parameter **t/min** und **t/sec**).

Um den Dauerlauf einzustellen müssen die Parameter **t/min** und **t/sec** auf Null gestellt werden. In der Zeit-Anzeige (t/min:s) erscheint "--:--".

Beispiel:



Die relative Zentrifugalbeschleunigung (RCF) ist vom Zentrifugerradius (RAD) abhängig. Während der Eingabe der RCF wird der eingestellte Zentrifugerradius angezeigt.

Wird nach der Anwahl oder während der Eingabe von Parametern 8 Sekunden lang keine Taste gedrückt, werden in der Anzeige wieder die vorherigen Werte angezeigt. Die Eingabe der Parameter muss dann erneut durchgeführt werden.

Durch Drücken der Taste  werden die Einstellungen gespeichert.

Bei Eingabe von mehreren Parametern muss die Taste  erst nach der Einstellung des letzten Parameters gedrückt werden.

Die Eingabe der Parameter kann jederzeit durch Drücken der Taste  abgebrochen werden. In diesem Fall werden die Einstellungen nicht gespeichert.



- Bei Bedarf die Taste drücken, um die RPM-Anzeige (RPM) oder die RCF-Anzeige (>RCF<) anzuwählen.



- Die Taste drücken. **t/min** : Laufzeit, Minuten.



- Mit den Tasten den gewünschten Wert einstellen.



- Die Taste drücken. **t/sec** : Laufzeit, Sekunden.

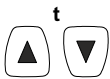

- Mit den Tasten den gewünschten Wert einstellen.



Fortsetzung nächste Seite

Beispiel: RPM-Anzeige (RPM)

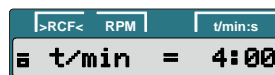
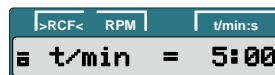
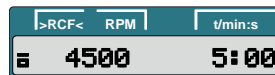

Beispiel: RCF-Anzeige (>RCF<)

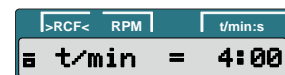
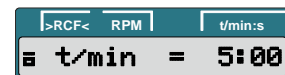
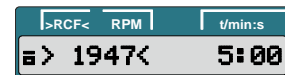



- Die Taste drücken.
RPM : Drehzahl.
RAD/mm : Zentrifugerradius.
 Die Anzeige und Eingabe des Zentrifugerradius ist nur möglich, wenn die RCF-Anzeige (>RCF<) angewählt ist.

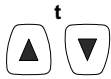

- Mit den Tasten den gewünschten Wert einstellen.



- Die Taste drücken.
R : Zentrifugerradius.
RCF : Relative Zentrifugalbeschleunigung.



- Mit den Tasten den gewünschten Wert einstellen.



- Die Taste drücken.
 \sim_DEC : Bremsstufe.
fast : kurze Auslaufzeit.
slow : lange Auslaufzeit.

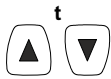

- Mit den Tasten den gewünschten Wert einstellen.



- Die Taste drücken, um die Einstellungen zu speichern.

**Beispiel:
RPM-Anzeige (RPM)**

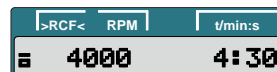

**Beispiel:
RCF-Anzeige (>RCF<)**

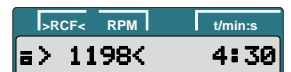
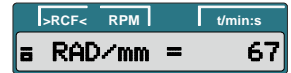
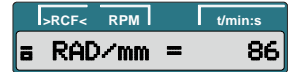

17 Zentrifugation



Während eines Zentrifugationslaufes dürfen sich gemäß EN / IEC 61010-2-020, in einem Sicherheitsbereich von 300 mm um die Zentrifuge herum, keine Personen, Gefahrstoffe und Gegenstände befinden.



Nach jedem Zentrifugationslauf, während dem Entriegeln des Deckels, wird kurzzeitig die verbleibende Anzahl der Laufzyklen (Zentrifugationsläufe) angezeigt.

Beispiel:



Wurde der zulässige Gewichtsunterschied innerhalb der Beladung des Rotors überschritten, wird der Zentrifugationslauf während des Anlaufs abgebrochen und es erscheint folgende Anzeige:



Ein Zentrifugationslauf kann jederzeit durch Drücken der Taste  abgebrochen werden.

Während eines Zentrifugationslaufes können Zentrifugations-Parameter angewählt und geändert werden. Die geänderten Werte sind jedoch nur für den aktuellen Zentrifugationslaufes gültig und werden nicht gespeichert.

Mit der Taste  kann jederzeit zwischen der RPM-Anzeige (RPM) und der RCF-Anzeige (>RCF<) umgeschaltet werden. Wird mit der RCF-Anzeige (>RCF<) gearbeitet, ist die Eingabe des Zentrifugerradius notwendig.

Erscheint folgende Anzeige



so ist eine weitere Bedienung der Zentrifuge erst nach Öffnen des Deckels möglich.

Bedienfehler und Störungen werden angezeigt (siehe Kapitel "Störungen").

- Den Netzschalter einschalten. Schalterstellung I.
- Den Rotor beladen und den Zentrifugendeckel schließen.

17.1 Zentrifugation mit Zeitvorwahl



- Bei Bedarf die Taste drücken, um die RPM-Anzeige (RPM) oder die RCF-Anzeige (>RCF<) anzuwählen.



- Die gewünschten Zentrifugations-Parameter eingeben (siehe Kapitel "Zentrifugations-Parameter eingeben").



- Die Taste drücken, um den Zentrifugationslauf zu starten. Während des Zentrifugationslaufes werden die Drehzahl des Rotors oder der daraus resultierende RCF-Wert, und die verbleibende Zeit angezeigt.



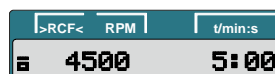

Fortsetzung nächste Seite

Beispiel:
RPM-Anzeige (RPM)

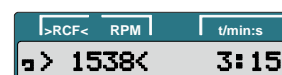
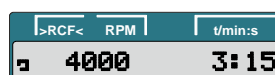
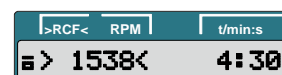
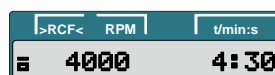
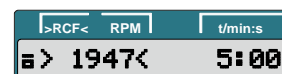

Beispiel:
RCF-Anzeige (>RCF<)



- Nach Ablauf der Zeit oder bei Abbruch des Zentrifugationslaufes durch Drücken der Taste , erfolgt der Auslauf mit der eingestellten Bremsstufe. Die Bremsstufe wird angezeigt. Beispiel $\sim f$

17.2 Dauerlauf



- Bei Bedarf die Taste drücken, um die RPM-Anzeige (RPM) oder die RCF-Anzeige (>RCF<) anzuwählen.



- Die gewünschten Zentrifugations-Parameter eingeben. Die Parameter **t/min** und **t/sec** auf Null stellen (siehe Kapitel "Zentrifugations-Parameter eingeben").



- Die Taste drücken, um den Zentrifugationslauf zu starten. Während des Zentrifugationslaufes werden die Drehzahl des Rotors oder der daraus resultierende RCF-Wert, und die gelaufene Zeit angezeigt.



- Die Taste drücken, um den Zentrifugationslauf zu beenden. Der Auslauf erfolgt mit der eingestellten Bremsstufe. Die Bremsstufe wird angezeigt. Beispiel $\sim f$

Beispiel: RPM-Anzeige (RPM)



Beispiel: RCF-Anzeige (>RCF<)

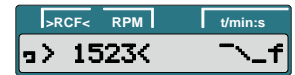

Beispiel: RPM-Anzeige (RPM)

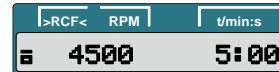

Beispiel: RCF-Anzeige (>RCF<)

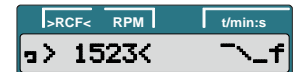
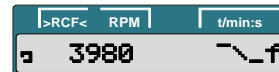
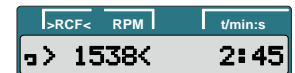
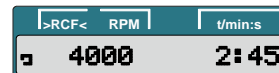
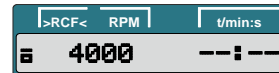
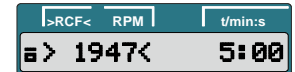

17.3 Kurzzeitzentrifugation



- Bei Bedarf die Taste drücken, um die RPM-Anzeige (RPM) oder die RCF-Anzeige (>RCF<) anzuwählen.



- Die gewünschten Zentrifugations-Parameter eingeben (siehe Kapitel "Zentrifugations-Parameter eingeben").



- Die Taste drücken und gedrückt halten. Während des Zentrifugationslaufes werden die Drehzahl des Rotors oder der daraus resultierende RCF-Wert, und die gelaufene Zeit angezeigt.



- Die Taste wieder loslassen um den Zentrifugationslauf zu beenden. Der Auslauf erfolgt mit der eingestellten Bremsstufe. Die Bremsstufe wird angezeigt. Beispiel \sim_f .

Beispiel: RPM-Anzeige (RPM)

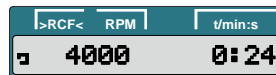

Beispiel: RCF-Anzeige (>RCF<)

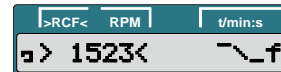
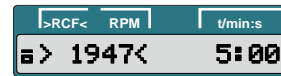

18 Not-Stopp



- Die Taste zweimal drücken. Beim Not-Stopp erfolgt der Auslauf mit Bremsstufe "fast" (kurze Auslaufzeit). Die Bremsstufe \sim_f wird angezeigt.

Beispiel: RPM-Anzeige (RPM)

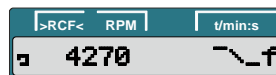

Beispiel: RCF-Anzeige (>RCF<)

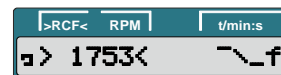

19 Zyklenzähler

 Die Verwendungsdauer des Rotors ist auf 50000 Laufzyklen (Zentrifugationsläufe) begrenzt.

Die Zentrifuge ist mit einem Zyklenzähler ausgestattet, der die Laufzyklen (Zentrifugationsläufe) zählt.

Nach jedem Zentrifugationslauf, während dem Entriegeln des Deckels, wird kurzzeitig die verbleibende Anzahl der Laufzyklen (Zentrifugationsläufe) angezeigt.

Beispiel:

```
>RCF< RPM | t/min:s
RemCycles= 16703
```

Ist die maximal zulässige Anzahl der Laufzyklen des Rotors überschritten, erscheint nach jedem Start eines Zentrifugationslaufes folgende Anzeige und der Zentrifugationslauf muss erneut gestartet werden.

```
>RCF< RPM | t/min:s
Cycles Passed
```



Erscheint folgende Anzeige

```
>RCF< RPM | t/min:s
Cycles Passed
```

muss der Rotor aus Sicherheitsgründen sofort gegen einen neuen Rotor ausgetauscht werden.

Nachdem der Rotor ausgetauscht wurde, muss der Zyklenzähler wieder auf "0" zurückgesetzt werden (siehe Kapitel "Zyklenzähler auf "0" zurücksetzen").

20 Einstellungen und Abfragen

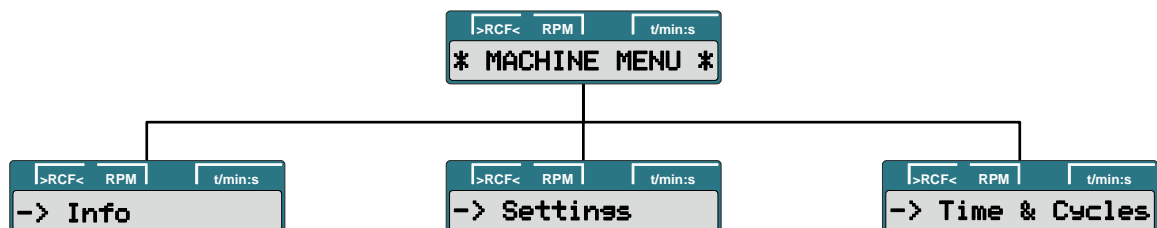

Abfrage:

- System-Informationen

Einstellung:

- Akustisches Signal
- Automatisches Entriegeln des Deckels nach dem Zentrifugationslauf
- Automatische Abschaltung der Hintergrundbeleuchtung
- Optisches Signal nach Beendigung des Zentrifugationslaufes

Abfrage:

- Betriebsstunden
- Anzahl der durchgeführten Zentrifugationsläufe

Einstellung:

- Zyklenzähler

20.1 System-Informationen abfragen

Folgende System-Informationen können abgefragt werden:

- Geräte-Modell und dessen maximale Drehzahl,
- Programmversion des Gerätes,
- Typ-Nummer des Gerätes,
- Herstellungsdatum des Gerätes,
- Seriennummer des Gerätes,
- Typ des Frequenzumrichters,
- Programmversion des Frequenzumrichters

Die Abfrage kann, bei Stillstand des Rotors, wie folgt durchgeführt werden:

Der Vorgang kann jederzeit durch Drücken der Taste  abgebrochen werden.



- Die Taste 8 Sekunden gedrückt halten.



- Die Taste drücken.



- Die Taste drücken.
Geräte-Modell und dessen maximale Drehzahl



- Die Taste drücken.
Programmversion des Gerätes.

Beispiel:



- Die Taste drücken.
Type#1 : Typ-Nummer des Gerätes.

Beispiel:



- Die Taste drücken.
Type#2 : Fortsetzung der Typ-Nummer, wenn diese mehr Stellen als das Anzeigefeld "Type#1" hat.

Beispiel:



- Die Taste drücken.
Herstellungsdatum des Gerätes.

Beispiel:



Fortsetzung nächste Seite



- Die Taste drücken.
Seriennummer des Gerätes.

Beispiel:

>RCF<	RPM	t/min:s
Serial#: 0016234		



- Die Taste drücken.
Typ des Frequenzumrichters.

Beispiel:

>RCF<	RPM	t/min:s
FC type LC 300VA		



- Die Taste drücken.
Programmversion des Frequenzumrichters.

Beispiel:

>RCF<	RPM	t/min:s
FC FW= D 1.04		



- Die Taste zweimal drücken, um das Menü "→ Info" zu verlassen oder dreimal drücken, um das "* MACHINE MENU *" zu verlassen.

Beispiel:

>RCF<	RPM	t/min:s
* MACHINE MENU *		

Beispiel:

>RCF<	RPM	t/min:s
⏪	4500	5:00

20.2 Akustisches Signal

Das akustische Signal ertönt:

- nach Auftreten einer Störung im 2 s-Intervall.
- nach Beendigung des Zentrifugationslaufes und Stillstand des Rotors im 30 s-Intervall.

Durch Drücken einer beliebigen Taste wird das akustische Signal beendet.

Das akustische Signal kann, bei Stillstand des Rotors, wie folgt eingestellt werden:

 Der Vorgang kann jederzeit durch Drücken der Taste  abgebrochen werden. In diesem Fall werden die Einstellungen nicht gespeichert.

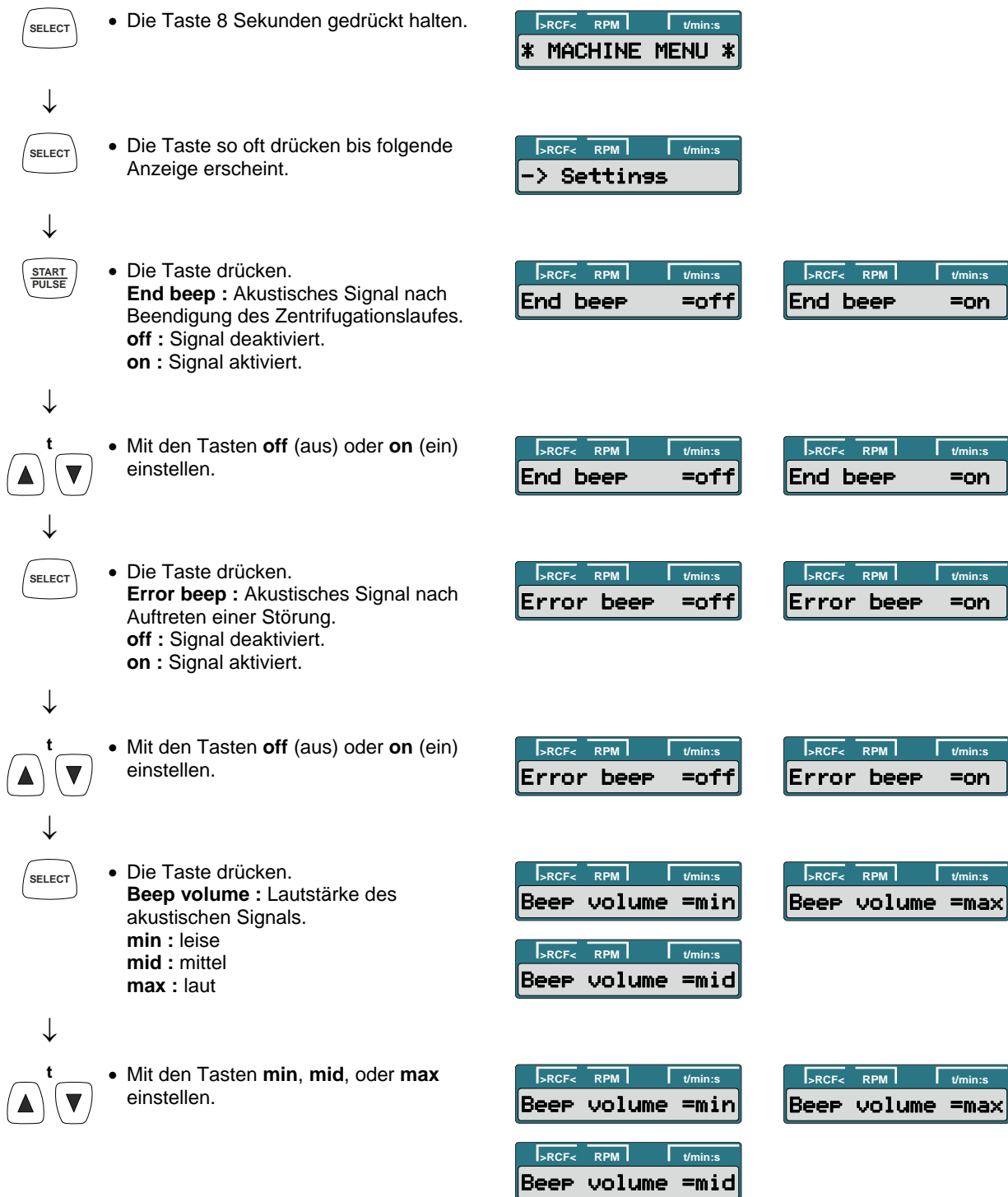

Fortsetzung nächste Seite



- Die Taste drücken, um die Einstellung zu speichern.



- Die Taste einmal drücken, um das Menü "-> Settings" zu verlassen oder zweimal drücken, um das "* MACHINE MENU *" zu verlassen.



Beispiel:



20.3 Optisches Signal nach Beendigung des Zentrifugationslaufes

Die Hintergrundbeleuchtung der Anzeige blinkt nach dem Zentrifugationslauf, um optisch zu signalisieren, dass der Zentrifugationslauf beendet ist.

Das optische Signal kann, bei Stillstand des Rotors, wie folgt ein- oder ausgeschaltet werden:

Der Vorgang kann jederzeit durch Drücken der Taste abgebrochen werden.



- Die Taste 8 Sekunden gedrückt halten.



- Die Taste so oft drücken bis folgende Anzeige erscheint.



- Die Taste drücken.



- Die Taste so oft drücken bis eine der beiden Anzeigen erscheint.
End blinking : Blinken der Hintergrundbeleuchtung der Anzeige nach dem Zentrifugationslauf.
off : Hintergrundbeleuchtung blinkt nicht.
on : Hintergrundbeleuchtung blinkt.



- Mit den Tasten **off** (aus) oder **on** (ein) einstellen.



- Die Taste drücken, um die Einstellung zu speichern.



- Die Taste einmal drücken, um das Menü "-> Settings" zu verlassen oder zweimal drücken, um das "* MACHINE MENU *" zu verlassen.





Beispiel:





















20.4 Automatisches Entriegeln des Deckels nach dem Zentrifugationslauf

Es kann eingestellt werden, ob der Deckel, nach dem Zentrifugationslauf, automatisch entriegelt oder nicht.

Bei Stillstand des Rotors kann dies wie folgt eingestellt werden:

 Der Vorgang kann jederzeit durch Drücken der Taste  abgebrochen werden. In diesem Fall werden die Einstellungen nicht gespeichert.

	<ul style="list-style-type: none"> Die Taste 8 Sekunden gedrückt halten. 		
↓			
	<ul style="list-style-type: none"> Die Taste so oft drücken bis folgende Anzeige erscheint. 		
↓			
	<ul style="list-style-type: none"> Die Taste drücken. 		
↓			
	<ul style="list-style-type: none"> Die Taste so oft drücken bis eine der beiden Anzeigen erscheint. Lid AutoOpen : Automatisches Entriegeln des Deckels nach dem Zentrifugationslauf. off : Deckel entriegelt nicht automatisch. on : Deckel entriegelt automatisch. 		
↓			
	<ul style="list-style-type: none"> Mit den Tasten off oder on einstellen. 		
↓			
	<ul style="list-style-type: none"> Die Taste drücken, um die Einstellung zu speichern. 		
↓			
	<ul style="list-style-type: none"> Die Taste einmal drücken, um das Menü "-> Settings" zu verlassen oder zweimal drücken, um das "* MACHINE MENU *" zu verlassen. 		<p>Beispiel:</p> 

20.5 Hintergrundbeleuchtung der Anzeige

Zum Einsparen von Energie kann eingestellt werden, dass nach einem Zentrifugationslauf, die Hintergrundbeleuchtung der Anzeige nach 2 Minuten ausschaltet.

Bei Stillstand des Rotors kann dies wie folgt eingestellt werden:

 Der Vorgang kann jederzeit durch Drücken der Taste  abgebrochen werden. In diesem Fall werden die Einstellungen nicht gespeichert.

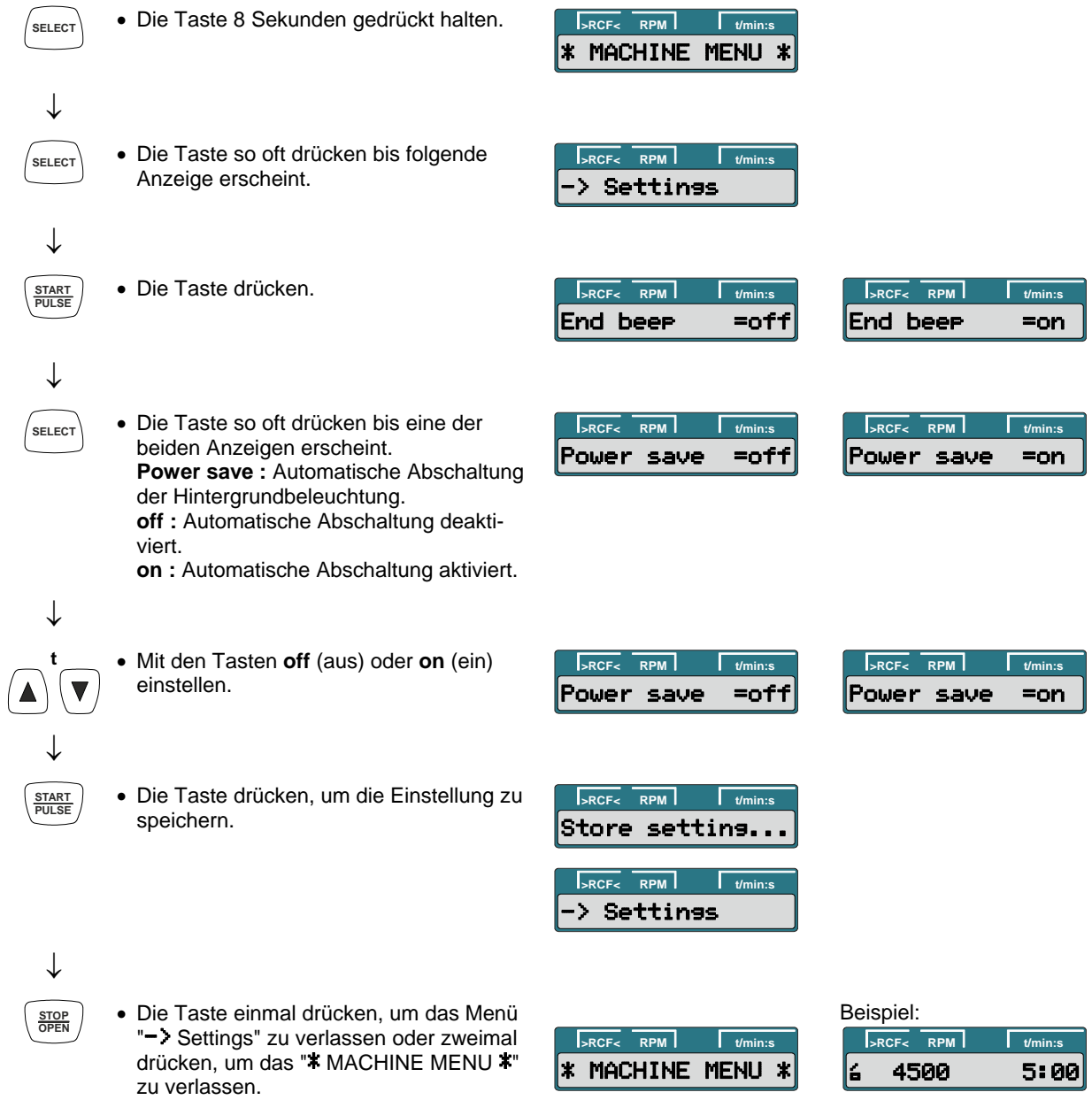

20.6 Die Betriebsstunden und die Anzahl der Zentrifugationsläufe abfragen

Die Betriebsstunden sind in interne und externe Betriebsstunden aufgeteilt.

Interne Betriebsstunden: Gesamte Zeit, die das Gerät eingeschaltet war.

Externe Betriebsstunden: Gesamte Zeit der bisherigen Zentrifugationsläufe.

Die Abfrage kann, bei Stillstand des Rotors, wie folgt durchgeführt werden:

 Der Vorgang kann jederzeit durch Drücken der Taste  abgebrochen werden.

SELECT

- Die Taste 8 Sekunden gedrückt halten.





SELECT

- Die Taste so oft drücken bis folgende Anzeige erscheint.





START PULSE

- Die Taste drücken.
TimeExt : Externe Betriebsstunden.

Beispiel:





SELECT

- Die Taste drücken.
TimeInt : Interne Betriebsstunden.

Beispiel:





SELECT

- Die Taste drücken.
Starts : Anzahl aller Zentrifugationsläufe.

Beispiel:





STOP OPEN

- Die Taste zweimal drücken, um das Menü "-> Time & Cycles" zu verlassen oder dreimal drücken, um das "* MACHINE MENU *" zu verlassen.



Beispiel:

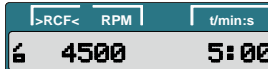

20.7 Zyklenzähler auf Null zurücksetzen

Nachdem der Rotor ausgetauscht wurde, muss der Zyklenzähler wieder auf Null zurückgesetzt werden.

 Der Zyklenzähler darf nur auf Null zurückgesetzt werden, wenn zuvor der Rotor gegen einen neuen Rotor ausgetauscht wurde.

Der Zyklenzähler kann, bei Stillstand des Rotors, wie folgt zurückgesetzt werden:

 Der Vorgang kann jederzeit durch Drücken der Taste  abgebrochen werden. In diesem Fall werden die Einstellungen nicht gespeichert.



- Die Taste 8 Sekunden gedrückt halten.



- Die Taste so oft drücken bis folgende Anzeige erscheint.



- Die Taste drücken.



- Die Taste so oft drücken bis folgende Anzeige erscheint.
Cyc sum : Anzahl der durchgeführten Laufzyklen.



- Die Taste drücken.



t



- Die Taste drücken.
Die Anzahl der durchgeführten Laufzyklen wird auf Null zurückgesetzt.



- Die Taste drücken, um die Einstellung zu speichern.



- Die Taste zweimal drücken, um das Menü "-> Time & Cycles" zu verlassen oder dreimal drücken, um das "* MACHINE MENU *" zu verlassen.



Beispiel:

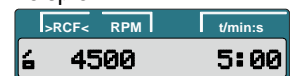

21 Relative Zentrifugalbeschleunigung (RCF)

Die relative Zentrifugalbeschleunigung (RCF) wird als Vielfaches der Erdbeschleunigung (g) angegeben. Sie ist ein einheitsfreier Zahlenwert und dient zum Vergleich der Trenn- und Sedimentationsleistung.

Die Berechnung erfolgt nach der Formel:

$$\text{RCF} = \left(\frac{\text{RPM}}{1000} \right)^2 \times r \times 1,118 \quad \Rightarrow \quad \text{RPM} = \sqrt{\frac{\text{RCF}}{r \times 1,118}} \times 1000$$

RCF = Relative Zentrifugalbeschleunigung

RPM = Drehzahl

r = Zentrifugierradius in mm = Abstand von der Mitte der Drehachse bis zum Zentrifugiergefäßboden.
Zentrifugierradius siehe Kapitel "Anhang/Appendix, Rotoren und Zubehör/
Rotors and accessories".

 Die relative Zentrifugalbeschleunigung (RCF) ist von der Drehzahl und dem Zentrifugierradius abhängig.

22 Zentrifugation von Stoffen oder Stoffgemischen mit einer höheren Dichte als 1,2 kg/dm³

Bei der Zentrifugation mit maximaler Drehzahl darf die Dichte der Stoffe oder Stoffgemische 1,2 kg/dm³ nicht überschreiten.

Bei Stoffen oder Stoffgemischen mit einer höheren Dichte muss die Drehzahl reduziert werden.

Die erlaubte Drehzahl lässt sich nach folgender Formel berechnen:

$$\text{Reduzierte Drehzahl (n}_{\text{red}}) = \sqrt{\frac{1,2}{\text{höhere Dichte [kg/dm}^3]}} \times \text{maximale Drehzahl [RPM]}$$

z.B.: Maximale Drehzahl 4000 RPM, Dichte 1,6 kg/dm³

$$n_{\text{red}} = \sqrt{\frac{1,2 \text{ kg/dm}^3}{1,6 \text{ kg/dm}^3}} \times 4000 \text{ RPM} = 3464 \text{ RPM}$$

Bei eventuellen Unklarheiten ist Auskunft beim Hersteller einzuholen.

23 Notentriegelung

Bei einem Stromausfall kann der Deckel nicht motorisch entriegelt werden. Es muss eine Notentriegelung von Hand durchgeführt werden.

 Zur Notentriegelung die Zentrifuge vom Netz trennen.
Den Deckel nur bei Stillstand des Rotors öffnen.

 VORSICHT! Beschädigung des Verschlusses, während der Notentriegelung, durch Drehen des Sechskant-Stiftschlüssels im Uhrzeigersinn (nach rechts).
Der Sechskant-Stiftschlüssel darf nur entgegen dem Uhrzeigersinn (nach links) gedreht werden, siehe Abbildung.

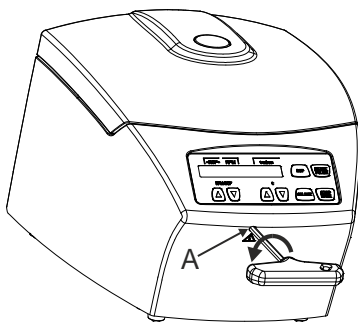

- Den Netzschalter ausschalten (Schalterstellung "0").
- Durch das Fenster im Deckel schauen, um sich zu vergewissern, dass der Rotor stillsteht.
- Den Sechskant-Stiftschlüssel waagrecht in die Bohrung (A) einführen und solange vorsichtig entgegen dem Uhrzeigersinn (nach links) drehen, bis der Deckel öffnet.
- Den Sechskant-Stiftschlüssel wieder aus der Bohrung herausziehen.

24 Pflege und Wartung



Das Gerät kann kontaminiert sein.



Vor der Reinigung den Netzstecker ziehen.

Bevor ein anderes als das vom Hersteller empfohlene Reinigungs- oder Dekontaminationsverfahren angewandt wird, hat sich der Benutzer beim Hersteller zu vergewissern, dass das vorgesehene Verfahren das Gerät nicht schädigt.

- Zentrifugen, Rotoren und das Zubehör dürfen nicht in Spülmaschinen gereinigt werden.
- Es darf nur eine Handreinigung und eine Flüssig-Desinfektion durchgeführt werden.
- Die Wassertemperatur muss 20 – 25°C betragen.
- Es dürfen nur Reinigungs- oder Desinfektionsmittel verwendet werden, die:
 - im pH-Bereich 5 - 8 liegen,
 - keine Ätzalkalien, Peroxide, Chlorverbindungen, Säuren und Laugen enthalten.
- Um Korrosionserscheinungen durch Reinigungs- oder Desinfektionsmittel zu vermeiden sind die speziellen Anwendungshinweise vom Hersteller des Reinigungs- oder Desinfektionsmittels unbedingt zu beachten.

24.1 Zentrifuge (Gehäuse, Deckel und Schleuderraum)

24.1.1 Oberflächenreinigung und -pflege

- Das Gehäuse der Zentrifuge und den Schleuderraum regelmäßig säubern und bei Bedarf mit Seife oder einem milden Reinigungsmittel und einem feuchten Tuch reinigen. Dies dient zum einen der Hygiene und es verhindert Korrosion durch anhaftende Verunreinigungen.
- Inhaltsstoffe geeigneter Reinigungsmittel:
Seife, anionische Tenside, nichtionische Tenside.
- Nach dem Einsatz von Reinigungsmitteln, die Reste des Reinigungsmittels, durch Nachwischen mit einem feuchten Tuch, entfernen.
- Die Flächen müssen unmittelbar nach der Reinigung getrocknet werden.
- Bei Bildung von Kondenswasser den Schleuderraum, durch Auswischen mit einem saugfähigen Tuch, trocknen.
- Der Schleuderraum ist jährlich auf Schäden zu überprüfen.



Werden sicherheitsrelevante Schäden festgestellt, darf die Zentrifuge nicht mehr in Betrieb genommen werden. In diesem Fall ist der Kundendienst zu benachrichtigen.

24.1.2 Oberflächendesinfektion

- Gelangt infektiöses Material in den Schleuderraum, so ist dieser umgehend zu desinfizieren.
- Inhaltsstoffe geeigneter Desinfektionsmittel:
Äthanol, n-Propanol, Ethylhexanol, anionische Tenside, Korrosionsinhibitoren.
- Nach dem Einsatz von Desinfektionsmitteln, die Reste des Desinfektionsmittels, durch Nachwischen mit einem feuchten Tuch, entfernen.
- Die Flächen müssen unmittelbar nach der Desinfektion getrocknet werden.

24.1.3 Entfernen radioaktiver Verunreinigungen

- Das Mittel muss speziell für das Entfernen radioaktiver Verunreinigungen ausgewiesen sein.
- Inhaltsstoffe geeigneter Mittel für das Entfernen radioaktiver Verunreinigungen:
Anionische Tenside, nichtionische Tenside, polyhydrierter Äthanol.
- Nach dem Entfernen der radioaktiven Verunreinigungen, die Reste des Mittels, durch Nachwischen mit einem feuchten Tuch, entfernen.
- Die Flächen müssen unmittelbar nach dem Entfernen der radioaktiven Verunreinigungen getrocknet werden.

24.2 Rotoren und Zubehör

24.2.1 Reinigung und Pflege

- Um einer Korrosion und Materialveränderungen vorzubeugen müssen die Rotoren und das Zubehör regelmäßig mit Seife oder einem milden Reinigungsmittel und einem feuchten Tuch gereinigt werden.. Die Reinigung wird mindestens einmal wöchentlich empfohlen. Verschmutzungen müssen sofort entfernt werden.
- Inhaltsstoffe geeigneter Reinigungsmittel:
Seife, anionische Tenside, nichtionische Tenside.
- Nach dem Einsatz von Reinigungsmitteln, die Reste des Reinigungsmittels, durch Nachspülen mit Wasser (nur außerhalb der Zentrifuge) oder Nachwischen mit einem feuchten Tuch, entfernen.
- Die Rotoren und das Zubehör müssen unmittelbar nach der Reinigung getrocknet werden.
- Bei Bio-Sicherheitssystemen (lieferbare Bio-Sicherheitssysteme siehe Kapitel "Anhang/Appendix, Rotoren und Zubehör/Rotors and accessories") sind die Dichtungsringe regelmäßig (wöchentlich) zu prüfen und zu reinigen. Bei Anzeichen von Rissbildung, Versprödung oder Abnutzung ist der Dichtungsring sofort auszutauschen. Um ein Verdrehen des Dichtungsringes während dem Öffnen und Schließen des Deckels zu vermeiden, muss der Dichtungsring mit Talkum-Puder oder einem Gummi-Pflegemittel leicht eingerieben werden.
- Um Korrosion infolge Feuchtigkeit zwischen Rotor und Motorwelle zu verhindern, sollte der Rotor mindestens einmal im Monat ausgebaut, gereinigt und die Motorwelle leicht gefettet werden.
- Die Rotoren und das Zubehör sind monatlich auf Verschleiß und Korrosionsschäden zu überprüfen.



Rotoren und Zubehör dürfen bei Anzeichen von Verschleiß oder Korrosion nicht mehr verwendet werden.

- Den Rotor wöchentlich auf festen Sitz prüfen.

24.2.2 Desinfektion

- Gelangt infektiöses Material auf die Rotoren oder auf das Zubehör, so muss eine geeignete Desinfektion durchgeführt werden.
- Inhaltsstoffe geeigneter Desinfektionsmittel:
Äthanol, n-Propanol, Ethylhexanol, anionische Tenside, Korrosionsinhibitoren.
- Nach dem Einsatz von Desinfektionsmitteln, die Reste des Desinfektionsmittels, durch Nachspülen mit Wasser (nur außerhalb der Zentrifuge) oder Nachwischen mit einem feuchten Tuch, entfernen.
- Die Rotoren und das Zubehör müssen unmittelbar nach der Desinfektion getrocknet werden.

24.2.3 Entfernen radioaktiver Verunreinigungen

- Das Mittel muss speziell für das Entfernen radioaktiver Verunreinigungen ausgewiesen sein.
- Inhaltsstoffe geeigneter Mittel für das Entfernen radioaktiver Verunreinigungen:
Anionische Tenside, nichtionische Tenside, polyhydrierter Äthanol.
- Nach dem Entfernen der radioaktiven Verunreinigungen, die Reste des Mittels, durch Nachspülen mit Wasser (nur außerhalb der Zentrifuge) oder Nachwischen mit einem feuchten Tuch, entfernen.
- Die Rotoren und das Zubehör müssen unmittelbar nach dem Entfernen der radioaktiven Verunreinigungen getrocknet werden.

24.2.4 Rotoren und Zubehör mit begrenzter Verwendungsdauer

Die Verwendungsdauer der Rotoren ist auf eine bestimmte Anzahl von Laufzyklen (Zentrifugationsläufe) begrenzt. Die maximal zulässige Anzahl der Laufzyklen ist auf dem Rotor ersichtlich.



Aus Sicherheitsgründen darf der Rotor nicht mehr verwendet werden, wenn die darauf gekennzeichnete maximal erlaubte Anzahl der Laufzyklen erreicht ist.

Das Gerät ist mit einem Zyklenzähler ausgestattet, der die Laufzyklen (Zentrifugationsläufe) zählt. Beschreibung siehe Kapitel "Zyklenzähler".

24.3 Autoklavieren



Die Rotoren dürfen bei 121°C / 250°F (20 min) autoklaviert werden.

Nach 10 Autoklavierungen muss der Rotor aus Sicherheitsgründen ausgetauscht werden.

Nach dem Autoklavieren muss gewartet werden, bis der Rotor auf Umgebungstemperatur abgekühlt ist, bevor er wieder verwendet werden darf.

Über den Sterilitätsgrad kann keine Aussage gemacht werden.



Die Deckel der Rotoren und Behälter müssen vor dem Autoklavieren abgenommen werden.

Das Autoklavieren beschleunigt den Alterungsprozess von Kunststoffen. Außerdem kann es bei Kunststoffen Farbveränderungen verursachen.

24.4 Zentrifugiergefäße

- Bei Undichtigkeit oder nach dem Bruch von Zentrifugiergefäßen, sind zerbrochene Gefäßteile, Glassplitter und ausgelaufenes Zentrifugiergut vollständig zu entfernen.
- Die Gummieinlagen sowie die Kunststoff-Hülsen der Rotoren sind nach einem Glasbruch zu ersetzen.



Verbleibende Glassplitter verursachen weiteren Glasbruch !

- Handelt es sich um infektiöses Material so ist umgehend eine Desinfektion durchzuführen.

25 Störungen



Lässt sich der Fehler laut Störungstabelle nicht beheben, so ist der Kundendienst zu benachrichtigen.

Bitte den Zentrifugentyp und die Seriennummer angeben. Beide Nummern sind auf dem Typenschild der Zentrifuge ersichtlich.



Einen NETZ-RESET durchführen:

- Den Netzschalter ausschalten (Schalterstellung "0").
- Mindestens 10 Sekunden lang warten und anschließend den Netzschalter wieder einschalten (Schalterstellung "I").

Anzeige		Ursache	Beseitigung
keine Anzeige		keine Spannung. Netzeingangssicherungen defekt.	<ul style="list-style-type: none"> - Versorgungsspannung überprüfen. - Netzeingangssicherungen überprüfen, siehe Kapitel "Netzeingangssicherungen wechseln". - Netzschalter EIN.
IMBALANCE		Der Rotor ist ungleichmäßig beladen.	<ul style="list-style-type: none"> - Nach Stillstand des Rotors den Deckel öffnen. - Die Beladung des Rotors überprüfen, siehe Kapitel "Beladen des Rotors". - Den Zentrifugationslauf wiederholen.
MAINS INTER	11	Netzunterbrechung während des Zentrifugationslaufes. (Der Zentrifugationslauf wurde nicht beendet.)	<ul style="list-style-type: none"> - Nach Stillstand des Rotors den Deckel öffnen. - Taste  drücken. - Bei Bedarf den Zentrifugationslauf wiederholen.
MAINS INTERRUPT			
TACHO ERROR	1, 2	Ausfall der Drehzahlimpulse.	<ul style="list-style-type: none"> - Nach Stillstand des Rotors einen NETZ-RESET durchführen.
LID ERROR	4.1 – 4.127	Fehler Deckelverriegelung	
OVER SPEED	5	Überdrehzahl	
VERSION ERROR	12	Falsches Zentrifugen-Modell erkannt. Fehler / Defekt Elektronik	<ul style="list-style-type: none"> - Nach Stillstand des Rotors einen NETZ-RESET durchführen.
UNDER SPEED	13	Unterdrehzahl	
CTRL ERROR	25.1, 25.2	Fehler / Defekt Elektronik	
CRC ERROR	27.1		
COM ERROR	31 – 36		
FC ERROR	60, 61.1 – 61.21, 61.64 – 61.142		
FC ERROR	61.23	Fehler Drehzahlmessung	<ul style="list-style-type: none"> - Das Gerät darf nicht ausgeschaltet werden, solange die Rotationsanzeige  rotierend aufleuchtet. Warten bis das Symbol  (Deckel verriegelt) angezeigt wird (nach ca. 120 Sekunden). Anschließend einen NETZ-RESET durchführen.
TACHO ERR	61.22		
FC ERROR	61.153	Fehler / Defekt Elektronik	<ul style="list-style-type: none"> - Einen NETZ-RESET durchführen. - Die Beladung des Rotors überprüfen, siehe Kapitel "Beladen des Rotors". - Den Zentrifugationslauf wiederholen.

26 Netzeingangssicherungen wechseln



Den Netzschalter ausschalten und das Gerät vom Netz trennen!

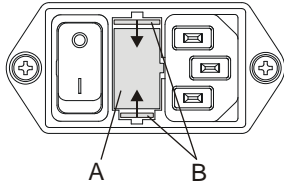

Der Sicherungshalter (A) mit den Netzeingangssicherungen befindet sich neben dem Netzschalter.

- Das Anschlusskabel aus dem Gerätestecker ziehen.
- Den Schnappverschluss (B) gegen den Sicherungshalter (A) drücken und diesen herausziehen.
- Defekte Netzeingangssicherungen austauschen.



Nur Sicherungen mit dem, für den Typ, festgelegten Nennwert verwenden, siehe nachfolgende Tabelle.

- Den Sicherungshalter wieder hineinschieben bis der Schnappverschluss einrastet.
- Das Gerät wieder ans Netz anschließen.

Modell	Typ	Sicherung	Best.-Nr.
MIKRO 185	1203	T 3,15 AH/250V	E997
MIKRO 185	1203-01	T 6,3 AH/250V	2266

27 Rücksendung von Geräten



Vor der Rücksendung des Gerätes muss die Transportsicherung eingebaut werden.

Wird das Gerät oder dessen Zubehör an die Firma Andreas Hettich GmbH & Co. KG zurückgesandt, so muss dieses, zum Schutz von Personen, Umwelt und Material, vor dem Versand dekontaminiert und gereinigt werden.

Eine Annahme von kontaminierten Geräten oder Zubehör behalten wir uns vor.

Anfallende Kosten für Reinigungs- und Desinfektionsmaßnahmen werden dem Kunden in Rechnung gestellt.

Wir bitten dafür um Ihr Verständnis.

28 Entsorgung

Vor der Entsorgung muss das Gerät, zum Schutz von Personen, Umwelt und Material, dekontaminiert und gereinigt werden.

Bei der Entsorgung des Geräts sind die jeweiligen gesetzlichen Vorschriften zu beachten.

Gemäß der Richtlinie 2002/96/EG (WEEE) dürfen alle nach dem 13.08.2005 gelieferten Geräte nicht mehr mit dem Hausmüll entsorgt werden. Das Gerät gehört zur Gruppe 8 (Medizinische Geräte) und ist in den Business-to-Business-Bereich eingeordnet.



Mit dem Symbol des durchgestrichenen Abfalleimers wird darauf hingewiesen, dass das Gerät nicht mit dem Hausmüll entsorgt werden darf.

Die Entsorgungsvorschriften der einzelnen EU-Länder können unterschiedlich sein. Im Bedarfsfall wenden Sie sich bitte an Ihren Lieferanten.

Contents

1	How to use these operating instructions	44
2	Symbol meanings	44
3	Intended use	44
4	Remaining risks	44
5	Technical specifications	45
6	Notes on safety	46
7	Transport and storage	48
7.1	Transport	48
7.2	Storage	48
8	Scope of delivery	48
9	Removing the transport securing device	49
10	Initial operation	49
11	Opening and closing the lid	50
11.1	Opening the lid	50
11.2	Closing the lid	50
12	Installation and removal of the rotor	50
13	Loading the rotor	51
14	Closing biosafety systems	51
15	Operating and display elements	52
15.1	Displayed symbols	52
15.2	Control panel keys	52
15.3	Setting options	53
16	Entering centrifugation parameters	54
16.1	Direct input of the centrifugation parameters	54
16.1.1	Speed (RPM)	54
16.1.2	Relative centrifugal force (RCF) and centrifugal radius (RAD)	54
16.1.3	Runtime	54
16.2	Input of the centrifugation parameters with the "SELECT" key	55
17	Centrifugation	57
17.1	Centrifugation with preset time	57
17.2	Continuous run	58
17.3	Short-term centrifugation	59
18	Emergency Stop	59
19	Cycle counter	60
20	Settings and queries	60
20.1	Querying system information	61
20.2	Acoustic signal	63
20.3	Optical signal after ending the centrifugation run	64
20.4	Automatic unlocking of the lid after the centrifugation run	65
20.5	Backlighting of the display	66
20.6	Querying the hours of operation and the number of centrifugation runs	67
20.7	Resetting the cycle counter to zero	68
21	Relative centrifugal force (RCF)	69

22	Centrifugation of materials or mixtures of materials with a density higher than 1.2 kg/dm ³	69
23	Emergency unlocking	69
24	Maintenance and servicing	70
24.1	Centrifuge (housing, lid and centrifuging chamber).....	70
24.1.1	Surface cleaning and care	70
24.1.2	Surface disinfection.....	70
24.1.3	Removal of radioactive contaminants	70
24.2	Rotors and Attachments.....	71
24.2.1	Cleaning and care.....	71
24.2.2	Disinfection	71
24.2.3	Removal of radioactive contaminants	71
24.2.4	Rotors and accessories with limited service lives	71
24.3	Autoclaving	72
24.4	Centrifuge containers	72
25	Faults	73
26	Change mains input fuses	74
27	Returning Devices	74
28	Disposal	74
29	Anhang / Appendix	141
29.1	Rotoren und Zubehör / Rotors and accessories.....	141

1 How to use these operating instructions

- Before using the centrifuge, read the operating instructions and observe them.
- The operating instructions are a part of the device. They must always be kept readily available.
- If the device is set up at a different location, the operating instructions must be provided with it.

2 Symbol meanings



Symbol on the device:

Attention, general hazard area.

Before using the device, make sure you read the operating instructions and observe the safety information!



Symbol in this document:

Attention, general hazard area.

This symbol refers to safety relevant warnings and indicates possibly dangerous situations.

The non-adherence to these warnings can lead to material damage and injury to personal.



Symbol on the device and in this document:

Beware of biohazard.



Symbol in this document:

This symbol refers to important circumstances.



Symbol on the device and in this document:

Symbol for the separate collection of electric and electronic devices according to the guideline 2002/96/EG (WEEE). The device belongs to Group 8 (medical devices).

Applies in the countries of the European Union, as well as in Norway and Switzerland.

3 Intended use

This device is a medical product (laboratory centrifuge) within the context of the IVD Directive 98/79/EC.

The centrifuge was designed only for the separation of materials or mixtures with a density of no more than 1.2 kg/dm³.

This includes sample preparations for molecular biological investigations in the clinical area. Here, centrifugation is a decisive step for extracting and purifying DNA and RNA from patient samples. In addition, many special kits are used routinely. If kits and spin columns are used, the centrifuge, with a sufficiently high centrifugal acceleration and its specially designed rotor for the centrifugation of spin column kits, meets the requirements for sample preparation in infection diagnostics.

The centrifuge is only meant for this purpose.

Another use or one which goes beyond this, is considered to be non-intended. The company Andreas Hettich GmbH & Co. KG is not liable for damage resulting from this.

Observing all information in the operating instructions and complying with the measures described therein is also a part of the intended use.

If the centrifuge is installed in another device or in a system, the manufacturer of the overall system is responsible for its safety.

4 Remaining risks

The device is built according to the state-of-the-art and the recognized safety regulations. If used and handled improperly, there could be life-threatening danger to the user or third parties, or the device could be impaired or there could be other property damage. The device is only to be used for its intended purpose and only when it is in safe working condition.

Malfunctions which could affect safety must be corrected immediately.

5 Technical specifications

Manufacturer	Andreas Hettich GmbH & Co. KG D-78532 Tuttlingen	
Model	MIKRO 185	
Type	1203	1203-01
Mains voltage ($\pm 10\%$)	200 - 240 V 1~	100 - 127 V 1~
Mains frequency	50 - 60 Hz	50 - 60 Hz
Connected load	390 VA	390 VA
Current consumption	1.8 A	3.6 A
Max. capacity	24 x 1.5 / 2.0 ml	
Allowed density	1.2 kg/dm ³	
Speed (RPM)	14000	
Force (RCF)	18845	
Kinetic energy	2450 Nm	
Obligatory inspection (BGR 500)	no	
Ambient conditions (EN / IEC 61010-1)	<p>Indoors only</p> <p>Up to 2000 m above sea level</p> <p>2°C to 40°C</p> <p>Maximum relative humidity 80% for temperatures up to 31°C, linearly decreasing to 50% relative humidity at 40°C.</p>	
– Set-up site		
– Altitude		
– Ambient temperature		
– Humidity		
– Excess-voltage category (IEC 60364-4-443)	II	
– Pollution degree	2	
Device protection class	I	
Not suitable for use in explosion-endangered areas.		
EMC		
– Emitted interference, Interference immunity	EN / IEC 61326-1, Class B	FCC Class B
Noise level (dependent on rotor)	≤ 59 dB(A)	
Dimensions		
– Width	261 mm	
– Depth	353 mm	
– Height	228 mm	
Weight	approx. 11 kg	

6 Notes on safety



No claim of warranty will be considered by the manufacturer unless ALL instructions in this manual have been followed.



- **The centrifuge should be installed on a good, stable base.**
- **Before using the centrifuge absolutely check the rotor for firm placement.**
- **When the centrifuge is running, according to EN / IEC 61010-2-020, no persons, dangerous substances or objects may be within the safety margin of 300 mm around the centrifuge.**
- **Rotors, suspensions and accessories that possess traces of corrosion or mechanical damage or if their term of use has expired may not be used any longer.**
- **The centrifuge may no longer be put into operation when the centrifuging chamber has safety-related damages.**
- **For centrifuges without temperature control, when the room temperature is increased and/or if the device is frequently used, the centrifuging chamber could be heated up. Therefore, it can't be ruled out that the sample material might be changed due to the temperature.**

- **Before the initial operation of your centrifuge you should read and pay attention to the operating instructions. Only personnel that has read and understood the operating instructions are allowed to operate the device.**
- Along with the operating instructions and the legal regulations on accident prevention, you should also follow the recognised professional regulations for working in a safe and professional manner. These operating instructions should be read in conjunction with any other instructions concerning accident prevention and environmental protection based on the national regulations of the country where the device is to be used.
- This centrifuge is a state-of-the-art piece of equipment which is extremely safe to operate. However, it can lead to danger for users or others if used by untrained staff, in an inappropriate way or for a purpose other than that it was designed for.
- The centrifuge must not be moved or knocked during operation.
- In case of fault or emergency release, never touch the rotor before it has stopped turning.
- To avoid damage due to condensate, when changing from a cold to a warm room the centrifuge must either heat up for at least 3 hours in the warm room before being connected to the mains, or run hot for 30 minutes in the cold room.
- Only the rotors and accessories approved by the manufacturer for this device may be used (see chapter "Anhang/Appendix, Rotoren und Zubehör/Rotors and accessories"). Before centrifuge vessels are used which are not listed in the chapter "Appendix, Rotors and accessories", the user must make sure they can be used by asking the manufacturer.
- The centrifuge rotor may only be loaded in accordance with the chapter "Loading the rotor".
- When centrifuging with maxim revolutions per minute the density of the materials or the material mixtures may not exceed 1.2 kg/dm^3 .
- The centrifuge may only be operated when the balance is within the bounds of acceptability.
- The centrifuge may not be operated in explosion-endangered areas.
- The centrifuge must not be used with:
 - inflammable or explosive materials
 - materials that react with one another producing a lot of energy.

- If users have to centrifuge hazardous materials or compounds contaminated with toxic, radioactive or pathogenic micro-organisms, they must take appropriate measures.
For hazardous substances centrifuge containers with special screw caps must strictly be used. In addition to the screw cap centrifuge containers, for materials in hazard category 3 and 4 a biosafety system must be used (see the World Health Organisation's "Laboratory Biosafety Manual").
In a biosafety system, droplets and aerosols are prevented from escaping by a bioseal (packing ring).
Damaged packing rings must not be used to seal the biosafety system.
Without the use of a biosafety system the centrifuge is not microbiologically sealed in the sense of the EN / IEC 61010-2-020 standard.
When closing a biosafety system, please observe the instructions provided in the chapter, "Closing Biosafety Systems".
For further details of available biosafety systems see chapter "Anhang/Appendix, Rotoren und Zubehör/Rotors and accessories". If in doubt, you should obtain relevant information from the manufacturer.
- The centrifuge must not be operated with highly corrosive substances which could impair the mechanical integrity of rotors, hangers and accessories.
- Repairs must only be carried out by personnel authorised to do so by the manufacturer.
- Only original spare parts and original accessories licensed by the Andreas Hettich GmbH & Co. KG company are allowed to be utilised.
- The following safety regulations apply:
EN / IEC 61010-1 and EN / IEC 61010-2-020 as well as their national deviations.
- The safe operation and reliability of the centrifuge can only be guaranteed if:
 - the centrifuge is operated in accordance with the operating instructions,
 - the electrical installation on the site where the centrifuge is installed conforms to the demands of EN / IEC stipulations,
 - the tests for device safety required in the respective countries, e.g. in Germany in acc. with BGV A1 and BGR 500, are carried out by an expert.

7 Transport and storage

7.1 Transport



Before transporting the device, the transport securing device must be installed.

When the device and accessories are transported, the following ambient conditions must be complied with:

- Ambient temperature: -20°C to +60°C
- Relative humidity: 20% to 80%, non-condensing

7.2 Storage



The device and the accessories may only be stored in closed and dry rooms.

When the device and accessories are stored, the following ambient conditions must be complied with:

- Ambient temperature: -20°C to +60°C
- Relative humidity: 20% to 80%, non-condensing

8 Scope of delivery

The following accessories are delivered with the centrifuge:

- 1 Power cord
- 2 fuses
- 1 hex head wrench
- 1 operating manual
- 1 information sheet, transport securing device
- 1 information sheet, emergency unlocking

The rotor(s) and associated accessories are included in the delivery in the quantity ordered.

9 Removing the transport securing device



It is imperative that the transport securing device be removed.

Keep the transport securing device in a safe place since it must be installed again before transporting the device.

The device may only be transported with the transport securing device installed.

To protect the device from damage during transport, the motor is fixed in place. This transport securing device must be removed when the device is put into operation.

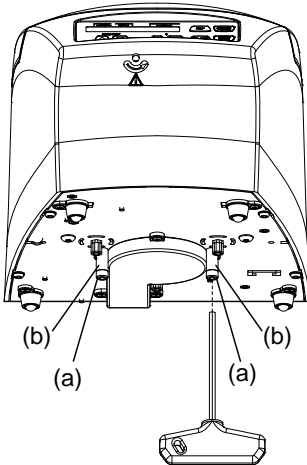

- Remove the two screws (a) and spacer sleeves (b).



The transport securing device is installed in the opposite order.

10 Initial operation

- Remove the transport securing device from the housing floor; see the "Removing the transport securing device" chapter.
- **Position the centrifuge in a stable and level manner in a suitable place. During set-up, the required safety margin of 300 mm around the centrifuge is to be kept according to EN / IEC 61010-2-020.**



When the centrifuge is running, according to EN / IEC 61010-2-020, no persons, dangerous substances or objects may be within the safety margin of 300 mm around the centrifuge.

- Ventilation openings may not be blocked.
A distance of 300 mm must be maintained from the ventilation slots and openings of the centrifuge.
- Check whether the mains voltage tallies with the statement on the type plate.
- Connect the centrifuge with the power cord to a standard mains socket. For connection ratings refer to Chapter "Technical specifications".
- Switch on the mains switch (switch position "I").
The following displays appear one after the other:
 1. The centrifuge model
 2. The type number and program version
 3. The last used centrifugation data



If the lid is closed, the message "Open the lid" is displayed.
In this case, open the lid to display the centrifugation data.

11 Opening and closing the lid

11.1 Opening the lid

 The lid can only be opened if the centrifuge is switched on and the rotor is stationary. If this shouldn't be possible, see the "Emergency unlock" chapter.

 When the cycle counter is activated, after a centrifugation run, while opening the lid, the remaining number of running cycles (centrifugation runs) is briefly displayed.

Example:



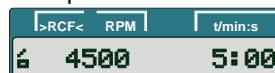

- Press the key.
The lid is unlocked by the motor.
 : Lid unlocked.

Example:



11.2 Closing the lid

 Do not reach with your fingers between the lid and housing.
Do not slam the lid closed.

- Put the lid on and lightly press the front edge of the lid down.
The lid is locked by the motor.
 : Lid locked.

Example:

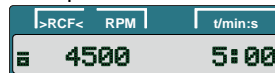

12 Installation and removal of the rotor

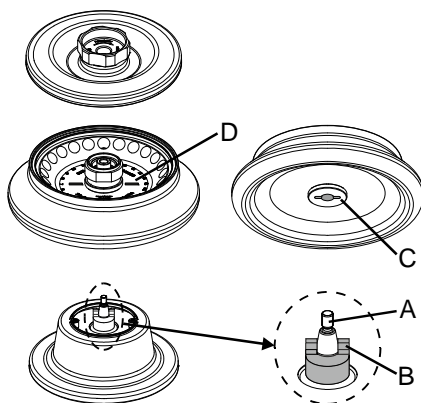

Installation:

- Clean the motor shaft (A) and the bore of the rotor and then apply a thin coat of grease to the motor shaft. Dirt particles between the motor shaft and rotor prevent the rotor from having a perfect seat and cause it to run unsteadily.
- Place the rotor vertically onto the motor shaft. The motor shaft dog (B) has to fit in the rotor slot (C). The alignment of the groove is labelled on the rotor (D).
- Tighten the clamping nut of the rotor with the Allen wrench (included in delivery) by turning clockwise.
- Check the rotor to make sure it is seated firmly.

Removal:

- Loosen the rotor's clamping nut by turning counter-clockwise with the Allen wrench (included in delivery) and turn up to the lifting pressure point. After overcoming the lifting pressure point, the rotor is released from the cone of the motor shaft. Turn the clamping nut until the rotor can be lifted up from the motor shaft.
- Lift up the rotor from the motor shaft.

13 Loading the rotor



Standard centrifuge containers of glass will not stand RCF values exceeding 4000 (DIN 58970, pg. 2).

- Check the rotor for firm seating.
- The rotors must be loaded symmetrically. The centrifuge containers have to be distributed evenly on all rotor positions. For authorised combinations see Chapter "Anhang/Appendix, Rotoren und Zubehör/Rotors and accessories".

Example:

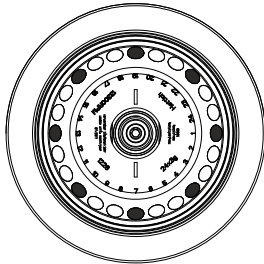

Rotor is evenly loaded

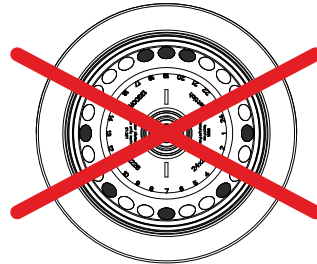

Not permitted!

Rotor is not evenly loaded

- The centrifuge containers may only be filled outside of the centrifuge.
- The maximum filling quantity for the centrifuge containers specified by the manufacturer must not be exceeded.

The centrifuging vessels may only be filled so far that no fluid can be expelled from them while the centrifuge is running.

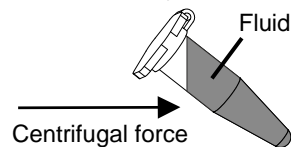

- When loading the rotor, no liquid may enter the rotor or the centrifuging chamber.
- In order to maintain the weight differences within the centrifuge container as marginal as possible, a consistent fill level in the containers is to be heeded.
- The weight of the permissible filling quantity is specified on each rotor. This weight may not be exceeded.

14 Closing biosafety systems



In order to guarantee that it is sealed, the lid to the biosafety system has to be firmly closed.

In order to prevent the packing ring from twisting when opening and closing the cover, the packing ring must be lightly rubbed with talcum powder or a rubber care product.

For further details of available biosafety systems see chapter "Anhang/Appendix, Rotoren und Zubehör/Rotors and accessories". If in doubt, you should obtain relevant information from the manufacturer.

Lid with screw closure and turning handle

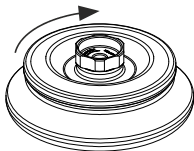

- Place the lid centred on the rotor.
- Tightly seal the lid by hand by turning the turning handle clockwise.

15 Operating and display elements

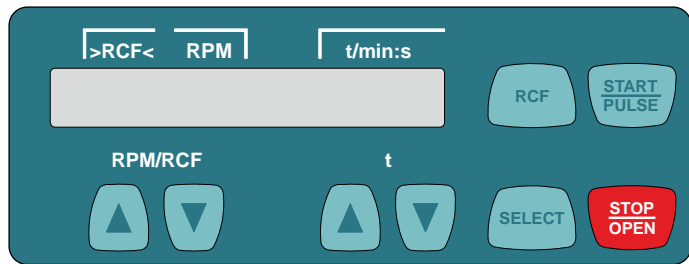

15.1 Displayed symbols



Lid unlocked.



Lid locked.



Rotation display. The rotation display lights up, rotating counterclockwise, as long as the rotor is turning.

15.2 Control panel keys

RPM/RCF



- Input the speed directly.
- If the key is kept pressed, the value changes with increasing speed.

t



- Input the runtime directly.
- Adjustable in steps of 1 second up to a minute, and in steps of 1 minute starting from 1 minute.
- Input the centrifuging parameters.
- If the key is kept pressed, the value changes with increasing speed.



- Selection key for activating the individual parameters. Every time the key is pressed, the next parameter is activated.
- Call up the "MACHINE MENU" (keep the key pressed for 8 seconds).
- In the "Machine Menu", select the menus "-> Info", "-> Settings" and "-> Time & Cycles".
- Scroll forward in the menus.



- Switching between the RPM display (RPM) and RCF display (>RCF<). RCF values are displayed in parentheses ><.
- RPM Speed
- RCF : Relative centrifugal acceleration



- Start the centrifugation run.
- Short-term centrifugation. Centrifugation is run as long as the key is kept pressed.
- Call up the menus "-> Info", "-> Settings" and "-> Time & Cycles".



- Finish the centrifugation run. The rotor runs down with a pre-selected brake stage. Pressing the key twice triggers the Emergency Stop.
- Unlock the lid.

15.3 Setting options

t/min Runtime. Adjustable from 1 - 99 min, in steps of 1 minute.

t/sec Runtime. Adjustable from 1 - 59 s, in steps of 1 second.

Continuous run "--:--". Set the parameters **t/min** and **t/sec** to zero.

RPM Speed

A number value from 200 rpm to the maximum speed of the rotor can be set. Adjustable from 200 RPM to 10000 RPM in steps of 10, and above 10000 RPM, in steps of 100. For the maximum rotor speed, see the chapter "Appendix, Rotors and accessories".

>RCF< Relative centrifugal force

A number value can be set which results in a speed between 200 rpm and the maximum rotor speed. Adjustable up to 10000 in steps of 1, and above 10000, in steps of 10.



It is only possible to input the relative centrifugal force (RCF) if the RCF display (>RCF<) is activated.

The relative centrifugal force (RCF) depends on the centrifuging radius (RAD). After entering the RCF, check to make sure that the correct centrifuging radius has been set.

RAD/mm Centrifuging radius

Adjustable from 10 mm to 250 mm, in steps of 1 mm. For the centrifuging radius, see the chapter "Appendix, Rotors and accessories".





It is only possible to input the centrifuging radius if the RCF display (>RCF<) is activated.

~_DEC Brake stage. **fast** = short run-out time, **slow** = long run-out time.

16 Entering centrifugation parameters

16.1 Direct input of the centrifugation parameters

The speed (RPM), the relative centrifugal force (RCF), the centrifuging radius (RAD) and the runtime can be input directly with the keys   without previously having to press the  key.



The set centrifugation parameters are only stored after starting the centrifugation run.

16.1.1 Speed (RPM)



- Press the key to activate the RPM display (RPM) as needed.

Example:



- Set the desired value with the keys.

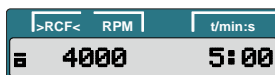

16.1.2 Relative centrifugal force (RCF) and centrifugal radius (RAD)



- Press the key to activate the RCF display (>RCF<) as needed.

Example:

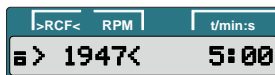

- Set the desired RCF value with the keys.

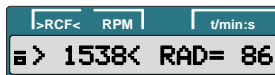

- Set the desired centrifuging radius with the keys as needed.

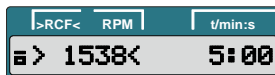

16.1.3 Runtime



Up to 1 minute, the runtime can be set in steps of 1 second, and starting from 1 minute, it can only be set in steps of 1 minute.

In order to set the continuous run, the parameters **t/min** and **t/sec** must be set to zero. In the time display (t/min:s), "--:--" appears.

Example:

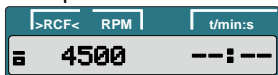

Example:

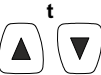

- Set the desired value with the keys.



16.2 Input of the centrifugation parameters with the "SELECT" key



The runtime can be set in minutes and seconds (parameters **t/min** and **t/sec**).

In order to set the continuous run, the parameters **t/min** and **t/sec** must be set to zero. In the time display (t/min:s), "--:--" appears.

Example:





The relative centrifugal acceleration (RCF) depends on the centrifuging radius (RAD).

During the input of the RCF, the set centrifuging radius is displayed.

If no key is pressed for 8 seconds after selection or during parameter input, the previous values are shown on the display. The parameters must then be input again.

By pressing the  button, the settings will be saved.

If several parameters are input, the  key must be pressed after setting the last parameter.

Entering parameters can be cancelled at any time by pressing the  key. In this case, the settings are not stored.

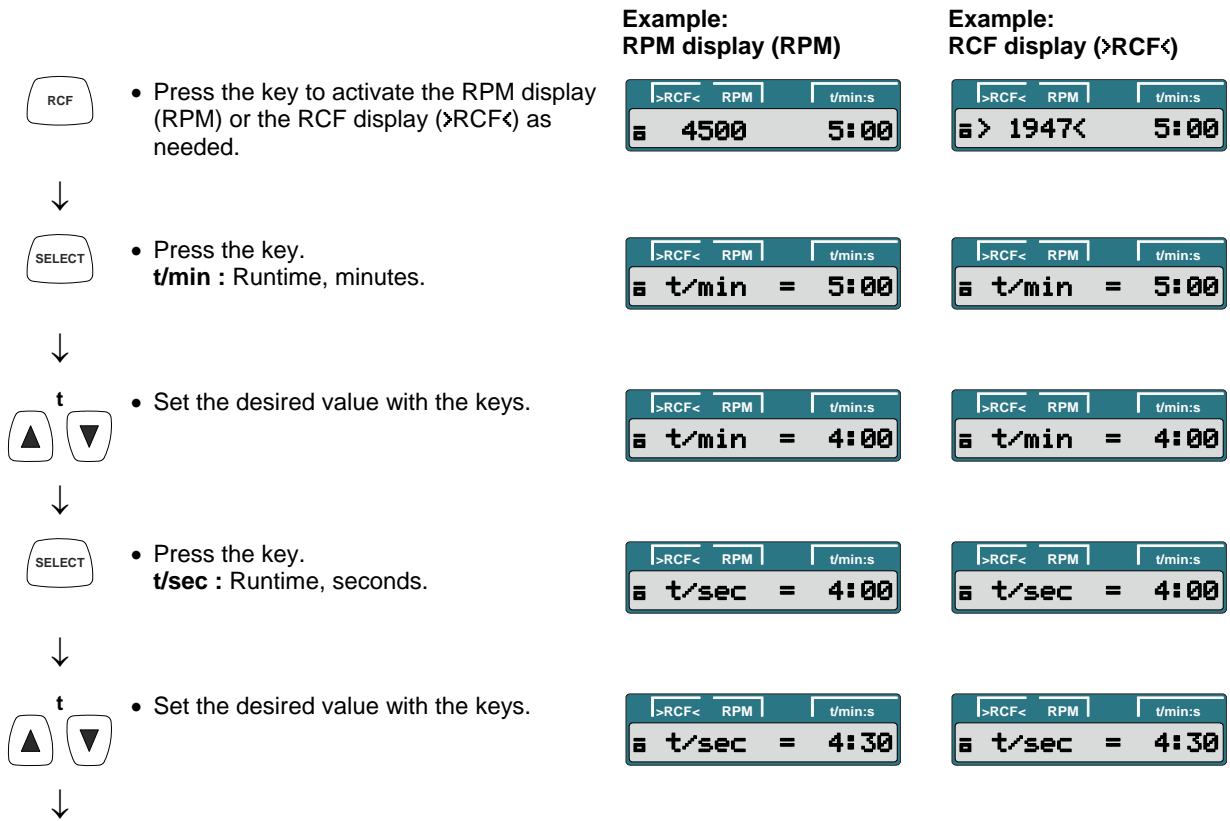

Continued on next page



- Press the key.
RPM : Speed.
RAD/mm : Centrifuging radius.
 It is only possible to display and input the centrifuging radius if the RCF display (>RCF<) is activated.



- Set the desired value with the keys.



- Press the key.
R : Centrifuging radius.
RCF : Relative centrifugal force



- Set the desired value with the keys.



- Press the key.
_DEC : Brake stage.
fast : short run-out time.
slow : long run-out time.



- Set the desired value with the keys.



- Press the button to save the settings.

**Example:
RPM display (RPM)**

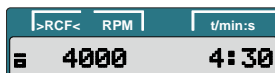

**Example:
RCF display (>RCF<)**

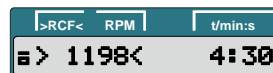

17 Centrifugation

 In accordance with EN / IEC 61010-2-020, no persons, hazardous substances or objects may be within a safety range 300 mm around the centrifuge during a centrifugation run.

 After each centrifugation run, while the lid is unlocking, the remaining number of running cycles (centrifugation runs) will be briefly displayed.

Example:



If the permissible weight difference was exceeded within the rotor load, the centrifugation run is aborted during start-up and the following will appear on the display:



A centrifugation run can be aborted at any time by pressing the  key.

During a centrifugation run, centrifugation parameters can be selected and changed. The changed values, however, only apply to the current centrifugation run and are not saved.

With the  key, you can toggle between the RPM display (RPM) and RCF display (>RCF<) at any time. If the RCF display (>RCF<) is worked with, the centrifuging radius must be input.

The following is displayed:



Further operation of the centrifuge is then only possible after opening the lid.

Operation errors and malfunctions will be shown (see the chapter on "Malfunctions").

- Plug in the mains switch. Switch position I.
- Load the rotor and close the centrifuge lid.

17.1 Centrifugation with preset time



- Press the key to activate the RPM display (RPM) or the RCF display (>RCF<) as needed.



- Enter the desired centrifugation parameters (see the chapter "Entering centrifugation parameters").



- Press the key to start the centrifugation run.
During the centrifugation run, the rotor speed or the resulting RCF value and remaining time are displayed.



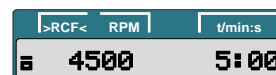

Press the key

Example:
RPM display (RPM)

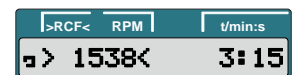
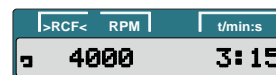
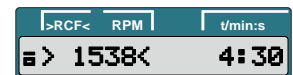
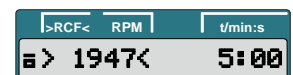

Example:
RCF display (>RCF<)



- After the time elapses or if the centrifugation run is aborted by pressing the  key, the run-out occurs with the set brake stage. The brake stage is displayed. Example 

Example:
RPM display (RPM)

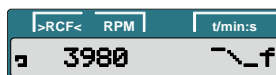

Example:
RCF display (>RCF<)

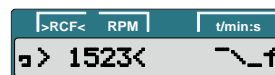

17.2 Continuous run



- Press the key to activate the RPM display (RPM) or the RCF display (>RCF<) as needed.



- Input the desired centrifugation parameters. Set the parameters **t/min** and **t/sec** to zero (see the chapter “Entering centrifugation parameters”).



- Press the key to start the centrifugation run. During the centrifugation run, the rotor speed or the resulting RCF value and elapsed time are displayed.



- Press the key to end the centrifugation run. The run-out occurs with the set brake stage. The brake stage is displayed. Example 

Example:
RPM display (RPM)

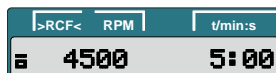

Example:
RCF display (>RCF<)

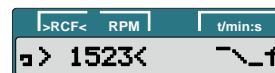
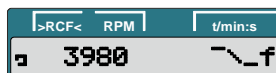
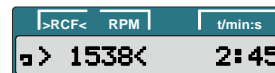
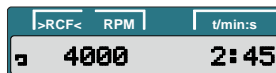
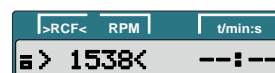
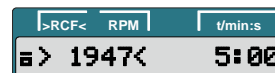

17.3 Short-term centrifugation



- Press the key to activate the RPM display (RPM) or the RCF display (>RCF<) as needed.



- Enter the desired centrifugation parameters (see the chapter “Entering centrifugation parameters”).



- Press the key and keep it pressed.
During the centrifugation run, the rotor speed or the resulting RCF value and elapsed time are displayed.



- Release the key again to end the centrifugation run.
The run-out occurs with the set brake stage. The brake stage is displayed. Example ~_f.

Example:
RPM display (RPM)

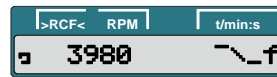
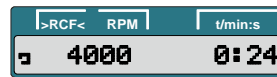

Example:
RCF display (>RCF<)

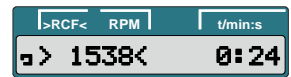

18 Emergency Stop



- Press the key twice.
During the Emergency Stop, the run-out occurs with the “fast” brake stage (short run-out time). Brake stage ~_f is displayed.

Example:
RPM display (RPM)



Example:
RCF display (>RCF<)



19 Cycle counter

 The period of use of the rotor is limited to 50000 running cycles (centrifugation runs).

The centrifuge is equipped with a cycle counter, which counts the running cycles (centrifugation runs).

After each centrifugation run, while the lid is unlocking, the remaining number of running cycles (centrifugation runs) will be briefly displayed.

Example:

```
>RCF< RPM | t/min:s
RemCycles= 16703
```

If the maximum permissible number of rotor running cycles has been exceeded, the following is displayed every time the centrifugation run is started and the centrifugation run must be restarted.

```
>RCF< RPM | t/min:s
Cycles Passed
```

 The following is displayed:

```
>RCF< RPM | t/min:s
Cycles Passed
```

the rotor must be immediately exchanged for a new rotor for safety reasons.

After the rotor has been exchanged, the cycle counter must be reset to "0" (see chapter "Resetting the cycle counter to '0'").

20 Settings and queries

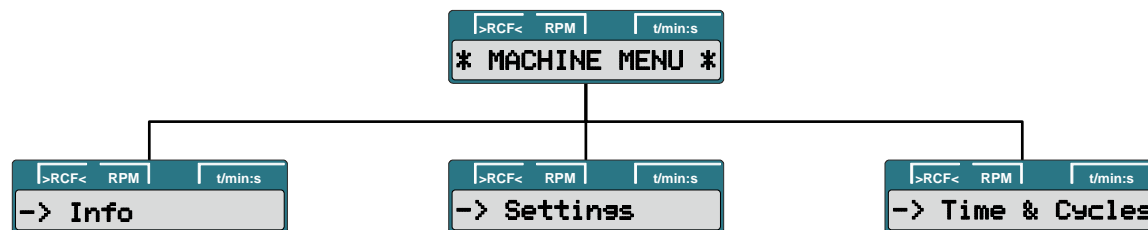

Query:

- System information

Setting:

- Acoustic signal
- Automatic unlocking of the lid after the centrifugation run
- Automatic switch-off of the background lighting
- Optical signal after ending the centrifugation run

Query:

- Hours of operation
- Number of completed centrifugation runs

Setting:



- Cycle counter

20.1 Querying system information

The following system information can be queried:

- Device model and its maximum speed,
- Program version of the device,
- Type number of the device,
- Device date of manufacture,
- Device serial number,
- Frequency converter type
- Frequency converter program version

With the rotor at a standstill, the query can proceed as follows:

 The procedure can be aborted at any time by pressing the  key.



- Press and hold the button for eight seconds.



- Press the key.



- Press the key.
Device model and its maximum speed.

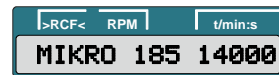

- Press the key.
Program version of the device.

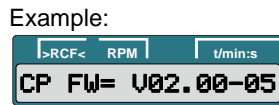

- Press the key.
Type#1 : Type number of the device.

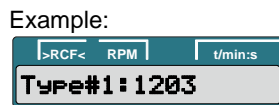

- Press the key.
Type#2 : Continuation of the type number if this has more positions than the "Type#1" display field.

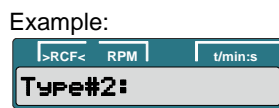

- Press the key.
Device date of manufacture.

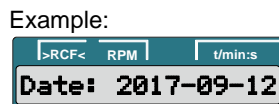

Continued on next page



- Press the key.
Device serial number.

Example:



- Press the key.
Frequency converter type.

Example:



- Press the key.
Frequency converter program version.

Example:



- Press the key twice to exit the "-> Info" menu or press three times to exit the "* MACHINE MENU *".

Example:

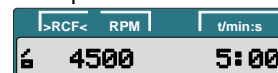



20.2 Acoustic signal

The acoustic signal sounds:

- after a malfunction occurs in a 2-second interval.
- after ending the centrifugation run and the rotor is at a standstill in a 30-second interval.

The acoustic signal is ended by pressing any key.

If the rotor is at a standstill, the acoustic signal can be set as follows:

 The procedure can be aborted at any time by pressing the  key. In this case, the settings are not stored.

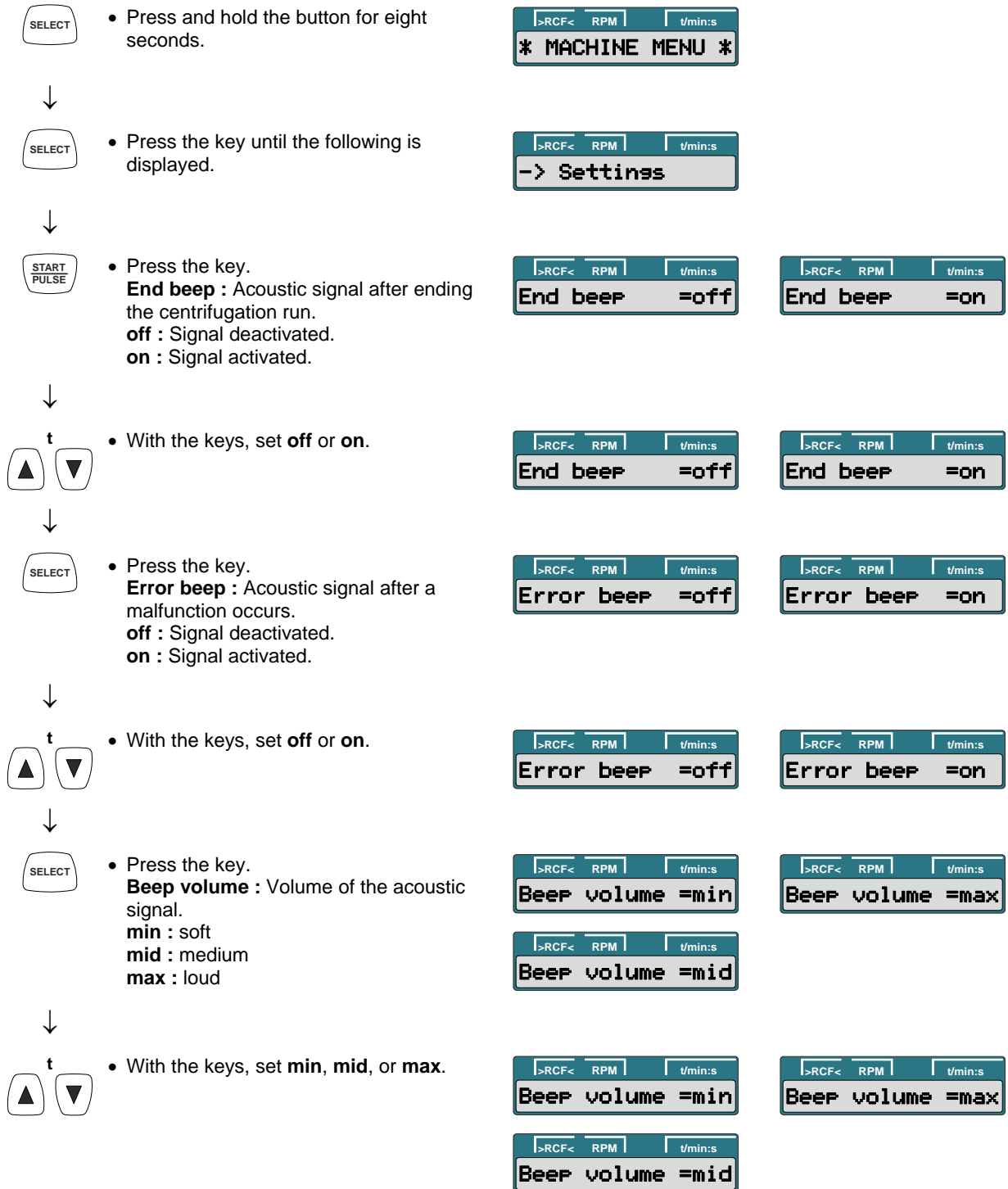

Continued on next page



- Press the button to save the setting.



- Press the key once to exit the "-> Settings" menu or press twice to exit the "* MACHINE MENU *".



Example:

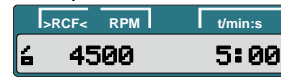

20.3 Optical signal after ending the centrifugation run

The backlighting of the display flashes after the centrifugation run to visually signalize that the centrifugation run has finished.

The optical signal can be switched on or off when the rotor is at a standstill:

The procedure can be aborted at any time by pressing the key.



- Press and hold the button for eight seconds.



- Press the key until the following is displayed.



- Press the key.



- Press the key until one of the following is displayed:
End blinking : Backlighting of display flashes after the centrifugation run.
off : Backlighting does not flash.
on : Backlighting flashes.



- With the keys, set **off** or **on**.



- Press the button to save the setting.



- Press the key once to exit the "-> Settings" menu or press twice to exit the "* MACHINE MENU *".



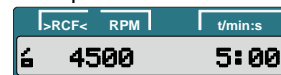

Example:



















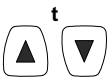

20.4 Automatic unlocking of the lid after the centrifugation run

It can be set whether the lid should automatically unlock or not after the centrifugation run.

With the rotor at a standstill, this can be set as follows:



 The procedure can be aborted at any time by pressing the  key. In this case, the settings are not stored.



















	<ul style="list-style-type: none"> Press and hold the button for eight seconds. 		
↓			
	<ul style="list-style-type: none"> Press the key until the following is displayed. 		
↓			
	<ul style="list-style-type: none"> Press the key. 		
↓			
	<ul style="list-style-type: none"> Press the key until one of the following is displayed: Lid AutoOpen : Automatic unlocking of the lid after the centrifugation run. off : Lid does not unlock automatically. on : Lid unlocks automatically. 		
↓			
	<ul style="list-style-type: none"> With the keys, set off or on. 		
↓			
	<ul style="list-style-type: none"> Press the button to save the setting. 		
↓			
	<ul style="list-style-type: none"> Press the key once to exit the "-> Settings" menu or press twice to exit the "* MACHINE MENU *". 		<p>Example:</p> 

20.5 Backlighting of the display

To save energy, it can be set that, after a centrifugation run, the backlighting of the display switches off after 2 minutes.

With the rotor at a standstill, this can be set as follows:

 The procedure can be aborted at any time by pressing the  key. In this case, the settings are not stored.

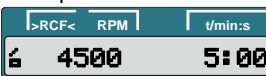
	<ul style="list-style-type: none"> Press and hold the button for eight seconds. 			
↓		<ul style="list-style-type: none"> Press the key until the following is displayed. 		
↓		<ul style="list-style-type: none"> Press the key. 		
↓		<ul style="list-style-type: none"> Press the key until one of the following is displayed: Power save : Automatic shutdown of the backlighting. off : Automatic shutdown deactivated. on : Automatic shutdown activated. 		
↓		<ul style="list-style-type: none"> With the keys, set off or on. 		
↓		<ul style="list-style-type: none"> Press the button to save the setting. 		
↓		<ul style="list-style-type: none"> Press the key once to exit the "-> Settings" menu or press twice to exit the "* MACHINE MENU *". 		<p>Example:</p> 



20.6 Querying the hours of operation and the number of centrifugation runs

The hours of operation are divided into internal and external hours of operation.

Internal hours of operation: Total time the device was switched on.

External hours of operation: Total time of the previous centrifugation runs.

With the rotor at a standstill, the query can proceed as follows:

 The procedure can be aborted at any time by pressing the  key.



- Press and hold the button for eight seconds.



- Press the key until the following is displayed.



- Press the key.
TimeExt : External hours of operation.

Example:



- Press the key.
TimeInt : Internal hours of operation.

Example:



- Press the key.
Starts : Number of all centrifugation runs.

Example:



- Press the key twice to exit the "-> Time & Cycles" menu or press three times to exit the "* MACHINE MENU *".



Example:

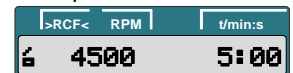

20.7 Resetting the cycle counter to zero

After the rotor has been exchanged, the cycle counter must be reset to zero again.



The cycle counter may only be reset to zero if the rotor has been exchanged for a new rotor first.

With the rotor at a standstill, the cycle counter can be reset as follows:



The procedure can be aborted at any time by pressing the  key. In this case, the settings are not stored.



- Press and hold the button for eight seconds.



- Press the key until the following is displayed.



- Press the key.

Example:



- Press the key until the following is displayed:
Cyc sum : Number of completed run cycles.



- Press the key.



- Press the key.
The number of completed run cycles is reset to zero.



- Press the button to save the setting.



- Press the key twice to exit the "-> Time & Cycles" menu or press three times to exit the "* MACHINE MENU *".



Example:

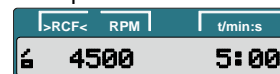

21 Relative centrifugal force (RCF)

The relative centrifugal force (RCF) is given as a multiple of the acceleration of gravity (g). It is a unit-free value and serves to compare the separation and sedimentation performance.

These values are calculated using the formula below:

$$\text{RCF} = \left(\frac{\text{RPM}}{1000} \right)^2 \times r \times 1,118 \quad \Rightarrow \quad \text{RPM} = \sqrt{\frac{\text{RCF}}{r \times 1,118}} \times 1000$$

RCF = relative centrifugal force

RPM = rotational speed (revolutions per minute)

r = centrifugal radius in mm = distance from the centre of the turning axis to the bottom of the centrifuge container. For more on the centrifugal radius see the chapter "Anhang/Appendix, Rotoren und Zubehör/Rotors and accessories".



The relative centrifugal force (RCF) stands in relation to the revolutions per minute and the centrifugal radius.

22 Centrifugation of materials or mixtures of materials with a density higher than 1.2 kg/dm³

When centrifuging with maximum revolutions per minute the density of the materials or the material mixtures may not exceed 1.2 kg/dm³.

The speed must be reduced for materials or mixtures of materials with a higher density.

The permissible speed can be calculated using the following formula:

$$\text{Reduced speed (n}_{\text{red}}) = \sqrt{\frac{1.2}{\text{Greater density [kg/dm}^3]}} \times \text{maximum speed [RPM]}$$

e.g.: maximum speed RPM 4000, density 1.6 kg/dm³

$$n_{\text{red}} = \sqrt{\frac{1.2 \text{ kg/dm}^3}{1.6 \text{ kg/dm}^3}} \times 4000 \text{ RPM} = 3464 \text{ RPM}$$

If in doubt you should obtain clarification from the manufacturer.

23 Emergency unlocking

In the event of a power failure, the lid cannot be unlocked with the motor. Emergency unlocking must be done by hand.



To unlock in an emergency, disconnect the centrifuge from the mains. Open the lid only when the rotor is at a standstill.



CAUTION! Damage to the lock during emergency unlocking by turning the hexagon Allen key in clockwise direction (to the right).

The Allen key may only be turned counter clockwise (to the left); see figure.

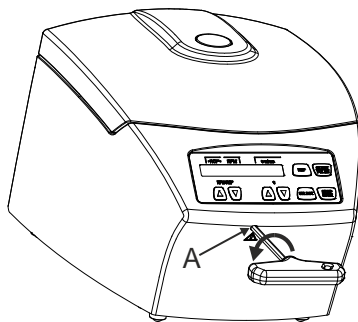

- Switch off the mains switch (switch setting "0").
- Look through the window in the lid to make sure that the rotor is at a standstill.
- Insert the Allen key horizontally in the bore (A) and turn carefully counter clockwise (to the left) until the lid opens.
- Pull the Allen key back out of the bore.

24 Maintenance and servicing



The device can be contaminated.



Pull the mains plug before cleaning.

Before any other cleaning or decontamination process other than that recommended by the manufacturer is applied, the user has to check with the manufacturer that the planned process does not damage the device.

- Centrifuges, rotors and accessories must not be cleaned in rinsing machines.
- They may only be cleaned by hand and disinfected with liquids.
- The water temperature must be between 20 – 25°C.
- Only detergents/disinfectants may be used which:
 - have a pH between 5 - 8
 - do not contain caustic alkalis, peroxides, chlorine compounds, acids and alkaline solutions
- In order to prevent appearances of corrosion through cleaning agents or disinfectants, the application guide from the manufacturer of the cleaning agent or disinfectant are absolutely to be heeded.

24.1 Centrifuge (housing, lid and centrifuging chamber)

24.1.1 Surface cleaning and care

- Clean the centrifuge housing and the centrifuging chamber regularly, using soap or a mild detergent and a damp cloth if required. For one thing, this services purposes of hygiene, and it also prevents corrosion through adhering impurities.
- Ingredients of suitable detergents: soap, anionic tensides, non-ionic tensides.
- After using detergents, remove the detergent residue by wiping with a damp cloth.
- The surfaces must be dried immediately after cleaning.
- In the event of condensation water formation, dry the centrifugal chamber by wiping out with an absorbent cloth.
- The centrifuging chamber is to be checked for damage once a year.



If damage is found which is relevant to safety, the centrifuge may no longer be put into operation. In this case, notify Customer Service.

24.1.2 Surface disinfection

- If infectious materials penetrates into the centrifugal chamber this is to be disinfected immediately.
- Ingredients of suitable disinfectants: ethanol, n-propanol, ethyl hexanol, anionic tensides, corrosion inhibitors.
- After using disinfectants, remove the disinfectant residue by wiping with a damp cloth.
- The surfaces must be dried immediately after disinfecting.

24.1.3 Removal of radioactive contaminants

- The agent must be specifically labelled as being an agent for removing radioactive contaminants.
- Ingredients of suitable agents for removing radioactive contaminants: anionic tensides, non-ionic tensides, polyhydrated ethanol.
- After removing the radioactive contaminants, remove the agent residue by wiping with a damp cloth.
- The surfaces must be dried directly after removing the radioactive contaminants.

24.2 Rotors and Attachments

24.2.1 Cleaning and care

- In order to avoid corrosion and changes in materials, the rotors and accessories have to be cleaned regularly with soap or with a mild cleaning agent and a moist cloth. Cleaning is recommended at least once a week. Contaminants must be removed immediately.
- Ingredients of suitable detergents:
soap, anionic tensides, non-ionic tensides.
- After using detergents, remove detergent residue by rinsing with water (only outside of the centrifuge) or wipe off with a damp cloth.
- The rotors and accessories must be dried directly after cleaning.
- In the case of biosafety systems (for further details of available biosafety systems see chapter "Anhang/Appendix, Rotoren und Zubehör/Rotors and accessories"), the packing rings must be checked and cleaned regularly (weekly). The sealing ring is to be replaced immediately upon indication of crack formation, embrittlement or abrasive wear. In order to prevent the packing ring from twisting when opening and closing the cover, the packing ring must be lightly rubbed with talcum powder or a rubber care product.
- In order to prevent corrosion as a result of moisture between the rotor and the motor shaft, the rotor should be disassembled and cleaned at least once a month, and the motor shaft should be lightly greased.
- The rotors and accessories have to be checked monthly for wear and tear and damage due to corrosion.



Rotors and attachments may no longer be utilised upon indication of wear and tear or corrosion.

- Check the firm seating of the rotor on a weekly basis.

24.2.2 Disinfection

- If infectious material should get on the rotors or accessories, they must be appropriately disinfected.
- Ingredients of suitable disinfectants:
ethanol, n-propanol, ethyl hexanol, anionic tensides, corrosion inhibitors.
- After using disinfectants, remove disinfectant residue by rinsing with water (only outside of the centrifuge) or wipe off with a damp cloth.
- The rotors and accessories must be dried directly after disinfection.

24.2.3 Removal of radioactive contaminants

- The agent must be specifically labelled as being an agent for the removal of radioactive contaminants.
- Ingredients of suitable agents for removing radioactive contaminants:
anionic tensides, non-ionic tensides, polyhydrated ethanol.
- After removing the radioactive contaminants, remove agent residue by rinsing with water (only outside of the centrifuge) or wipe off with a damp cloth.
- The rotors and accessories must be dried directly after removing the radioactive contaminants.

24.2.4 Rotors and accessories with limited service lives

The usage period of the rotors is limited to a certain number of run cycles (centrifugation runs). The maximum permissible number of run cycles can be seen on the rotor.



For safety reasons, the rotor may no longer be used when the maximum allowed number of running cycles (marked on it) has been reached.

The device is equipped with a cycle counter which counts the running cycles (centrifugation runs). For a description, see the "Cycle counter" chapter.

24.3 Autoclaving



The rotors may be autoclaved at 121°C / 250°F (20 min).

After 10 autoclaving cycles, the rotor must be exchanged for safety reasons.

After autoclaving, it must be waited until the rotor has cooled down to the ambient temperature before it may be used again.

No statement can be made about the degree of sterility.



The lids of the rotors and containers must be removed prior to autoclaving.

Autoclaving accelerates the ageing process of plastics. In addition, it can cause discolourations in plastics.

24.4 Centrifuge containers

- With leakiness or after the breakage of centrifuging containers broken container parts, glass splinters and leaked centrifugation material are to be completely removed.
- The rubber inserts as well as the plastic sleeves of the rotors are to be replaced after a glass breakage.



Remaining glass splinters cause further glass breakage!

- If this concerns infectious material, a disinfection process is to be executed immediately.

25 Faults



If the fault cannot be eliminated with the help of the fault table, please inform Customer Service.

Please specify the type of centrifuge and the serial number. Both numbers can be found on the name plate of the centrifuge.



Perform a MAINS RESET:

- Switch off the mains switch (switch position "0").
- Wait at least 10 seconds and then switch on the mains switch again (switch position "I").

Message / fault		Cause	Remedy	
No display		No voltage Mains input fuses defective.	<ul style="list-style-type: none"> - Check distribution voltage. - Check mains power input fuse, refer to Chapter "Change mains input fuse". - Mains switch ON. 	
IMBALANCE		The rotor is unevenly loaded.	<ul style="list-style-type: none"> - Open the lid after the rotor is at a standstill. - Check the loading of the rotor, see chapter "Loading the rotor". - Repeat the centrifugation run. 	
MAINS INTER	11	Power failure during the centrifugation run. (The centrifugation run was not finished.)	<ul style="list-style-type: none"> - Open the lid after the rotor is at a standstill. - Push  button. - Repeat the centrifugation run if necessary. 	
MAINS INTERRUPT				
TACHO ERROR	1, 2	Failure of speed impulses during operation.	<ul style="list-style-type: none"> - Perform a MAINS RESET when the rotor has been stationary. 	
LID ERROR	4.1 – 4.127	Error in lid locking or lid closure.		
OVER SPEED	5	Rotation too fast		
VERSION ERROR	12	Incorrect centrifuge model recognized. Error / defect electronics	<ul style="list-style-type: none"> - Perform a MAINS RESET when the rotor has been stationary. 	
UNDER SPEED	13			Rotation too slow
CTRL ERROR	22.1, 25.2			Error / defect electronics
CRC ERROR	27.1			
COM ERROR	31 – 36			
FC ERROR	60, 61.1 – 61.21, 61.64 – 61.142			
FC ERROR	61.23	Speed measurement error	<ul style="list-style-type: none"> - The device may not be switched off as long as the rotation display  is lit up and rotating. Wait until the symbol  (lid locked) is displayed (after approx. 120 seconds). Afterwards, carry out a MAINS RESET. 	
TACHO ERR	61.22			
FC ERROR	61.153	Error / defect electronics	<ul style="list-style-type: none"> - Perform a MAINS RESET. - Check the loading of the rotor, see chapter "Loading the rotor". - Repeat the centrifugation run. 	

26 Change mains input fuses



Switch off the mains switch and separate the device from the mains!

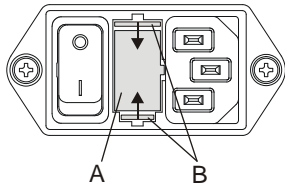

The fuse holder (A) with the mains input fuses is located next to the mains switch.

- Remove the connecting cable from the machine plug socket.
- Press the snap-fit (B) against the fuse holder (A) and remove.
- Exchange defective mains input fuses.



Only use fuses with the rating defined for the type. See the following table.

- Reinsert the fuse holder until the snap-fit clicks shut.
- Reconnect the device to the mains supply.

Model	Type	Fuse	Order no.
MIKRO 185	1203	T 3,15 AH/250V	E997
MIKRO 185	1203-01	T 6,3 AH/250V	2266

27 Returning Devices



Before returning the device, a transport securing device has to be installed.

If the device or its accessories are returned to Andreas Hettich GmbH & Co. KG, in order to provide protection for people, the environment and materials, it has to be decontaminated and cleaned before being shipped.

We reserve the right to refuse contaminated devices or accessories.

Costs incurred for cleaning and disinfection are to be charged to the customer.

We ask for your understanding in this matter.

28 Disposal

Before disposal, the device must be decontaminated and cleaned to protect people, the environment and property.

When you are disposing of the device, the respective statutory rules must be observed.

Pursuant to guideline 2002/96/EC (WEEE), all devices supplied after August 13, 2005 may not be disposed as part of domestic waste. The device belongs to group 8 (medical devices) and is categorized in the business-to-business field.



The icon of the crossed-out trash can shows that the device may not be disposed as part of domestic waste.

The waste disposal guidelines of the individual EC countries might vary. If necessary, contact your supplier.

Table des matières

1	Utilisation de ce mode d'emploi	77
2	Signification des symboles.....	77
3	Utilisation conforme	77
4	Risques résiduels	77
5	Données techniques	78
6	Consignes de sécurité	79
7	Transport et stockage	81
7.1	Transport	81
7.2	Stockage.....	81
8	Etendue de la livraison.....	81
9	Retirer les dispositifs de sécurité pour le transport	82
10	Mise en service	82
11	Ouvrir et fermer le couvercle	83
11.1	Ouvrir le couvercle	83
11.2	Fermer le couvercle	83
12	Montage et démontage du rotor	83
13	Chargement du rotor	84
14	Fermeture des systèmes de sécurité biologique	84
15	Éléments de commande et d'affichage.....	85
15.1	Pictogrammes	85
15.2	Touches du champ de commande	85
15.3	Réglages possibles	86
16	Saisir les paramètres de centrifugation	87
16.1	Saisie directe des paramètres de centrifugation	87
16.1.1	Vitesse de rotation (RPM).....	87
16.1.2	Accélération centrifuge relative (RCF) et rayon de centrifugation (RAD)	87
16.1.3	Durée de fonctionnement.....	87
16.2	Saisie des paramètres de centrifugation avec la touche "SELECT"	88
17	Centrifugation	90
17.1	Centrifugation avec présélection temps	90
17.2	Cycle de centrifugation court.....	92
18	Arrêt d'urgence.....	92
19	Compteur de cycles.....	93
20	Réglages et demandes	93
20.1	Demander des informations sur le système	94
20.2	Signal sonore	96
20.3	Signal optique à la fin du cycle de centrifugation	97
20.4	Déverrouillage automatique du couvercle après le cycle de centrifugation.....	98
20.5	Eclairage d'arrière-plan de l'affichage	99
20.6	Demander les heures de fonctionnement et le nombre de cycles de centrifugation	100
20.7	Remettre le compteur de cycles à zéro.....	101
21	Accélération centrifuge relative (RCF).....	102
22	Centrifugation de matières et de mélanges d'une densité supérieure à 1,2 kg/dm ³	102

23	Déverrouillage de secours.....	102
24	Entretien et maintenance	103
24.1	Centrifugeuse (boîtier, couvercle et cuve)	103
24.1.1	Entretien et nettoyage des surfaces	103
24.1.2	Désinfection des surfaces.....	103
24.1.3	Décontamination de substances radioactives.....	103
24.2	Rotors et accessoires	104
24.2.1	Nettoyage et entretien	104
24.2.2	Désinfection	104
24.2.3	Décontamination de substances radioactives.....	104
24.2.4	Rotors et accessoires à durée d'utilisation limitée	104
24.3	Autoclave	105
24.4	Réservoirs de centrifugation	105
25	Défauts.....	106
26	Changer les fusibles d'entrée de secteur	107
27	Renvoi d'appareils au fabricant	107
28	Élimination des déchets	107
29	Anhang / Appendix.....	141
29.1	Rotoren und Zubehör / Rotors and accessories.....	141

1 Utilisation de ce mode d'emploi

- Lisez et respectez impérativement les consignes et indications contenues dans le mode d'emploi avant d'utiliser la centrifugeuse.
- Le mode d'emploi fait partie intégrante de l'appareil. Vous devez le conserver de manière à toujours être à portée de main.
- Si vous changez l'appareil de place, le mode d'emploi doit suivre l'appareil.

2 Signification des symboles



Symbole sur l'appareil :

Attention, zone de danger général.

Avant utilisation de l'appareil, il est indispensable de lire le mode d'emploi et de respecter les consignes relatives à la sécurité!



Symbole dans ce document:

Attention, zone de danger général.

Ce symbole indique des consignes de sécurité et signale des situations pouvant être sources de danger. Le non-respect de ces instructions peut entraîner des dégâts matériels et personnels.



Symbole sur l'appareil et dans ce document:

Avertissement de menace biologique pour l'environnement.



Symbole dans ce document:

Ce symbole signale des informations importantes.



Symbole sur l'appareil et dans ce document:

Symbole pour la collecte séparée des appareils électriques et électroniques, conformément à la directive 2002/96(EG (WEEE). L'appareil fait partie du groupe 8 (appareils de médecine).

Utilisation dans les pays de l'Union Européenne ainsi qu'en Norvège et en Suisse.

3 Utilisation conforme

L'appareil dont il est question est un produit médical (centrifugeuse de laboratoire) dans l'esprit de la directive IVD 98/79/CE.

La centrifugeuse sert à la séparation de substances ou mélanges de substances d'une densité maximum de 1,2 kg/dm³.

Les préparations de prélèvements pour examens biomoléculaires dans le domaine clinique en font partie. La centrifugation constitue alors une étape décisive lors de l'extraction et du nettoyage d'ADN et d'ARN provenant de prélèvements de patients. Pour cela, on utilise de nombreuses fois, dans la routine, des kits spéciaux. Si on utilise des kits avec des tubes à vis, la centrifugeuse, avec une accélération centrifuge suffisamment élevée et son rotor spécialement conçu pour la centrifugation de kits à tubes à vis, satisfait aux exigences de la préparation de prélèvements dans le diagnostic d'infection.

La centrifugeuse est exclusivement destinée à cette plage d'utilisation.

Toute utilisation en dehors ou au delà de ce cadre est considérée comme non conforme. L'entreprise Andreas Hettich GmbH & Co. KG décline toute responsabilité pour tout dommage en résultant.

L'utilisation conforme comprend également le respect de toutes les indications contenues dans le mode d'emploi et des travaux d'inspection et d'entretien.

Si la centrifugeuse est montée dans un autre appareil ou intégrée dans un système, c'est le fabricant du système complet qui est responsable de sa sécurité.

4 Risques résiduels

L'appareil est construit conformément au niveau actuel de la technologie et des règles de sécurité éprouvées. L'utilisation et la manipulation non conforme de cet appareil risquent de menacer la santé et l'intégrité corporelle de l'utilisateur ou de tierces personnes, ou de détériorer l'appareil ou autres biens matériels. Utilisez exclusivement l'appareil conformément à l'usage pour lequel il a été conçu et uniquement s'il est dans un état de fonctionnement technique irréprochable.

Remédier sans attendre à tout dérangement susceptible de porter atteinte à la sécurité.

5 Données techniques

Fabricant	Andreas Hettich GmbH & Co. KG D-78532 Tuttlingen	
Modèle	MIKRO 185	
Type	1203	1203-01
Tension du réseau ($\pm 10\%$)	200 - 240 V 1~	100 - 127 V 1~
Fréquence du réseau	50 - 60 Hz	50 - 60 Hz
Charge de connexion	390 VA	390 VA
Consommation de courant	1.8 A	3.6 A
Capacité max.	24 x 1.5 / 2.0 ml	
Densité admise	1.2 kg/dm ³	
Vitesse de rotation (RPM)	14000	
Accélération (RCF)	18845	
Energie cinétique	2450 Nm	
Obligation de contrôle (BGR 500)	non	
Conditions ambiantes (EN / IEC 61010-1)	uniquement dans les intérieurs Jusqu'à 2000 m au dessus du niveau de la mer 2°C à 40°C humidité de l'air max. relative 80% pour températures jusqu'à 31°C, décroissant en linéaire jusqu'à 50% de l'humidité relative pour 40°C.	
– Emplacement		
– Hauteur		
– Température ambiante		
– Humidité de l'air		
– Catégorie de surtension (IEC 60364-4-443)	II	
– Degré d'encrassement	2	
Catégorie de protection de l'appareil	I	
Non approprié pour l'usage dans un environnement exposé aux explosions.		
EMV		
– Emission de parasites, Résistance aux interférences	EN / IEC 61326-1, catégorie B	FCC Class B
Niveau du bruit (en fonction du rotor)	≤ 59 dB(A)	
Dimensions		
– Largeur	261 mm	
– Profondeur	353 mm	
– Hauteur	228 mm	
Poids	env. 11 kg	

6 Consignes de sécurité



Aucune demande garantie ne pourra être revendiquée auprès du fabricant si les indications données dans ce mode d'emploi ne sont pas toutes respectées.



- **Veiller à la stabilité de la centrifugeuse.**
- **Avant d'utiliser la centrifugeuse, il est indispensable de vérifier la fixation correcte du rotor.**
- **Durant un processus de centrifugation, aucune personne, matière dangereuse et aucun objet ne doivent se trouver dans une zone de sécurité de 300 mm autour de la centrifugeuse selon EN / IEC 61010-2-020.**
- **Les rotors, balanciers et accessoires qui présentent d'importantes traces de corrosion ou des défauts mécaniques ou dont la durée d'utilisation a expiré ne doivent plus être utilisés.**
- **Suspendre immédiatement l'utilisation de la centrifugeuse si la cuve de centrifugeuse présente des dommages susceptibles de porter atteinte à la sécurité.**
- **Concernant les centrifugeuses sans réglage de température, il peut y avoir un réchauffement dans la cuve de centrifugeuse en cas de température ambiante élevée et/ou d'utilisation fréquente de l'appareil. Il n'est donc pas possible d'exclure une modification de l'échantillon due à la température.**

- **Il importe de lire et de respecter le mode d'emploi avant la mise en service de la centrifugeuse. Seules les personnes ayant lu et compris le mode d'emploi sont autorisées à manipuler l'appareil.**
- Outre le mode d'emploi et les réglementations contraignantes relatives à la prévention des accidents, il importe également de respecter les règles spécifiques et communément admises en matière de sécurité et de travail. Le mode d'emploi doit être complété des dispositions nationales applicables à la prévention des accidents et à la protection de l'environnement.
- La centrifugeuse a été construite conformément à l'état actuel de la technique et son fonctionnement est sûr. Elle peut cependant présenter des dangers pour l'utilisateur ou des tiers si son utilisation n'est pas confiée à un personnel dûment formé, est inadéquate ou non conforme à sa destination.
- Pendant le fonctionnement, la centrifugeuse ne devra pas être déplacée ou être heurtée.
- En cas de défaillance ou en cas de déverrouillage d'urgence, ne jamais intervenir dans l'appareil lorsque le rotor tourne.
- Afin d'éviter les dommages causés par la condensation en passant d'un local froid à un local chaud, il faut soit réchauffer la centrifugeuse en la laissant pendant au moins 3 heures dans le local chaud avant de la raccorder au secteur, soit la faire fonctionner pendant 30 minutes dans le local froid pour la chauffer.
- Pour cet appareil, vous ne devez utiliser que des rotors et des accessoires homologués par le fabricant (voir chapitre "Anhang/Appendix, Rotoren und Zubehör/Rotors and accessories"). Avant d'utiliser des récipients de centrifugation qui ne sont pas présentés dans le chapitre "Annexe/Appendix, rotors et accessoire/Rotors and accessories", l'utilisateur doit s'assurer auprès du fabricant qu'il peut les utiliser.
- Le rotor de la centrifugeuse doit uniquement être chargé conformément au chapitre "Chargement du rotor".
- Dans le cas de la centrifugation à la vitesse maximale, la densité des substances et des mélanges de substances ne doit pas excéder $1,2 \text{ kg/dm}^3$.
- Il est interdit de procéder à des centrifugations en présence de défauts d'équilibrage.
- La centrifugeuse ne doit pas être exploitée dans un environnement explosif.
- Il est interdit de procéder à des centrifugations :
 - avec des matières inflammables ou explosives,
 - avec des matières susceptibles de réagir chimiquement ou de dégager d'importantes quantités d'énergie.

- En cas de centrifugation de substances dangereuses ou de substances mixtes toxiques, radioactives ou contaminées par des micro-organismes pathogènes, il incombe à l'utilisateur de prendre les mesures ad hoc.
Il faut systématiquement utiliser des récipients de centrifugation avec des bouchons spéciaux à vis destinés aux substances dangereuses. Dans le cas des substances des groupes de risques 3 et 4, il faut utiliser un système de sécurité biologique en plus des récipients de centrifugation pouvant être obturés (voir le manuel "Laboratory Biosafety Manual" publié par l'Organisation Mondiale de la Santé).
Dans un système de sécurité biologique, un joint biologique (bague d'étanchéité) empêche la fuite de gouttelettes et d'aérosols.
Les bagues endommagées ne doivent plus être utilisées pour assurer l'étanchéité le système de sécurité biologique.
En l'absence d'un système de sécurité biologique, une centrifugeuse n'est pas étanche du point de vue microbiologique au sens de la norme EN / IEC 61010-2-020.
Lors de la fermeture d'un système de sécurité biologique, il faut se conformer aux instructions du chapitre "Fermeture des systèmes de sécurité biologique".
Pour ce qui concerne les systèmes à sécurité biologique, voir le chapitre "Anhang/Appendix, Rotoren und Zubehör/Rotors and accessories". Dans le doute vous pouvez obtenir les informations auprès du fabricant.
- Il est interdit de centrifuger des matières fortement corrosives pouvant réduire la résistance mécanique des rotors, des supports et des accessoires.
- Les réparations ne peuvent être effectuées que par une personne autorisée à cet effet par le fabricant.
- Utiliser uniquement les pièces de rechange originales et les accessoires d'origine homologués par les Etablissements Andreas Hettich GmbH & Co. KG.
- Les dispositions de sécurité suivantes font foi :
EN / IEC 61010-1 et EN / IEC 61010-2-020 ainsi que les dérogations nationales.
- La sécurité et la fiabilité de la centrifugeuse seront uniquement garanties si :
 - la centrifugeuse est utilisée conformément aux instructions du mode d'emploi,
 - l'installation électrique du site de la centrifugeuse est conforme aux prescriptions EN / IEC,
 - les contrôles prescrits dans les différents pays en matière de sécurité de l'appareil, par ex. en Allemagne selon BGV A1 et BGR 500 sont effectués par un professionnel.

7 Transport et stockage

7.1 Transport



Installer le dispositif de sécurité pour le transport avant de transporter l'appareil.

Respecter les conditions ambiantes suivantes pour transporter l'appareil et ses accessoires :

- Température ambiante : -20°C à +60°C
- Humidité relative de l'air : 20% à 80%, non condensante

7.2 Stockage



Ne stocker l'appareil et ses accessoires que dans une pièce fermée au sec.

Respecter les conditions ambiantes suivantes pour stocker l'appareil et ses accessoires :

- Température ambiante : -20°C à +60°C
- Humidité relative de l'air : 20% à 80%, non condensante

8 Etendue de la livraison

Les accessoires suivants sont fournis avec la centrifugeuse:

- 1 Cordon de raccordement au secteur
- 2 fusibles
- 1 clé mâle six-pans
- 1 mode d'emploi
- 1 fiche de notes concernant la sécurité du transport
- 1 fiche de notes concernant le déverrouillage de secours

Le(s) rotor(s) et accessoires correspondant sont livrés selon les spécifications de la commande.

9 Retirer les dispositifs de sécurité pour le transport



Retirez impérativement les dispositifs de sécurité pour le transport.

Conservez ces dispositifs de sécurité afin de les réutiliser lors du transport ultérieur de l'appareil (leur montage est obligatoire).

Le transport de l'appareil est exclusivement autorisé avec les dispositifs de sécurité correspondants.

Pour protéger l'appareil pendant le transport, on fixe le moteur.

Retirez impérativement ces dispositifs de sécurité pour le transport avant la mise en service de l'appareil.

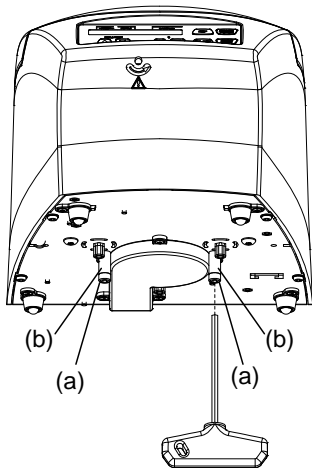

- Enlevez les deux vis (a) et douilles d'écartement (b).



Pour remonter les dispositifs de sécurité pour le transport, procédez dans l'enchaînement inverse.

10 Mise en service

- Retirez les dispositifs de sécurité pour le transport au fond du boîtier, voir chapitre "Retirer les dispositifs de sécurité pour le transport".
- **Placer la centrifugeuse sur un emplacement approprié de manière à ce qu'elle soit stable et mettre de niveau. Lors de la mise en place, il faut respecter la zone de sécurité exigée de 300mm autour de la centrifugeuse selon EN / IEC 61010-2-020.**



Durant un processus de centrifugation, aucune personne, matière dangereuse et aucun objet ne doivent se trouver dans une zone de sécurité de 300 mm autour de la centrifugeuse selon EN / IEC 61010-2-020.

- Ne pas recouvrir les fentes d'aération.
Veuillez respecter un écart de 300 mm jusqu'aux fentes et ouvertures d'aération de la centrifugeuse.
- Vérifier que la tension de secteur est identique à la mention de la plaque signalétique.
- Brancher la centrifugeuse avec son cordon de raccordement sur une prise secteur aux normes. Puissance connectée voir chapitre "Données techniques".
- Allumer l'interrupteur de réseau (position du commutateur "I").
Vous voyez s'afficher successivement :
 1. le modèle de centrifugeuse
 2. le numéro type et la version du programme
 3. les données de la dernière centrifugation utilisée



Quand le couvercle est fermé, le message "Open the lid" s'affiche.
Dans ce cas, ouvrir le couvercle afin que les données de centrifugation s'affichent.

11 Ouvrir et fermer le couvercle

11.1 Ouvrir le couvercle



Vous ne pouvez ouvrir le couvercle que si la centrifugeuse est en marche et le rotor à l'arrêt. Si cela n'est pas possible, consulter le chapitre "Déverrouillage d'urgence".



Si le compteur de cycles est activé, le nombre de cycles de centrifugation restants s'affiche brièvement, après un cycle de centrifugation, pendant l'ouverture du couvercle.

Exemple :



- Appuyer sur la touche. Le couvercle se déverrouille de manière motorisée.
 : couvercle déverrouillé.

Exemple :



11.2 Fermer le couvercle



Ne pas mettre les doigts entre le couvercle et le boîtier.
 Ne pas fermer le couvercle violemment.

- Poser le couvercle et appuyer légèrement sur le bord avant du couvercle. Le couvercle se verrouille de manière motorisée.
 : couvercle verrouillé.

Exemple :

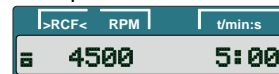

12 Montage et démontage du rotor

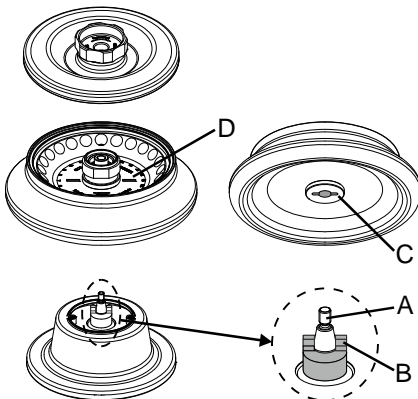

Montage :

- Nettoyer l'arbre moteur (A) et l'ouverture du rotor, graisser ensuite légèrement l'arbre moteur. La présence d'impuretés entre l'arbre moteur et le rotor empêche au rotor d'avoir une position parfaite, et provoque un fonctionnement irrégulier du rotor.
- Placer le rotor à la verticale sur l'arbre moteur. L'entraîneur (B) sur l'arbre moteur doit se trouver dans la rainure (C) du rotor. La direction de la rainure est indiquée sur le rotor (D).
- Avec la clé hexagonale fournie, serrer l'écrou du rotor en tournant dans le sens des aiguilles d'une montre.
- Vérifier si le rotor se trouve dans une position fixe.

Démontage :

- Avec la clé hexagonale fournie, desserrer l'écrou du rotor en tournant dans le sens inverse des aiguilles d'une montre, et tourner jusqu'au point de pression pour le retrait. Après avoir franchi ce point de pression, le rotor se détache du cône de l'arbre moteur. Tourner l'écrou jusqu'à pouvoir soulever le rotor de l'arbre moteur.
- Ôter le rotor de l'arbre moteur.

13 Chargement du rotor



Des récipients standard de centrifugation en verre sont résistants jusqu' à un ACR de 4000 (DIN 58970, partie 2).

- Vérifier la stabilité d'assise du rotor.
- Les rotors doivent uniquement être chargés de manière symétrique. Les conteneurs de centrifugation doivent être uniformément répartis sur toutes les positions du rotor. Pour les combinaisons possibles, voir le Chapitre "Anhang/Appendix, Rotoren und Zubehör/Rotors and accessories".

Exemple:

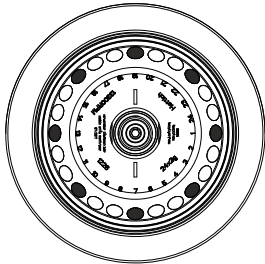

Rotor uniformément chargé

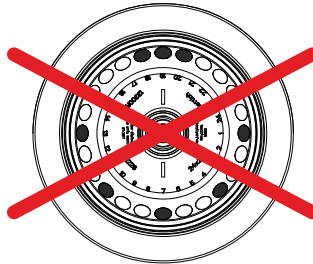

Non autorisé !
Rotor irrégulièrement chargé

- Remplissez les réservoirs de centrifugation uniquement en dehors de la centrifugeuse.
- La quantité maximale de remplissage indiquée par le fabricant pour les récipients de centrifugation ne doit pas être dépassée.

Remplir les réservoirs de centrifugation de sorte que du liquide ne puisse pas être projeté à l'extérieur pendant le cycle de centrifugation.

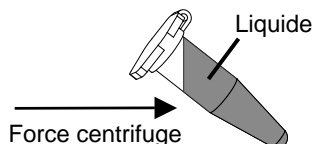

- Aucun fluide ne doit pénétrer dans le rotor et dans la cuve de centrifugeuse lors du chargement du rotor.
- La hauteur de remplissage des récipients sera autant que possible égale pour maintenir les différences de poids entre les récipients de centrifugation aussi réduites que possible.
- Le poids du volume de remplissage autorisé est indiqué sur chaque rotor. Il est interdit de dépasser cette tare.

14 Fermeture des systèmes de sécurité biologique



Pour garantir l'étanchéité, le couvercle d'un système de sécurité biologique doit être solidement fermé.

Pour éviter de fausser la bague d'étanchéité en ouvrant et en fermant le couvercle, il faut frotter légèrement la bague d'étanchéité avec de la poudre de talc ou un produit d'entretien pour caoutchouc.

Pour ce qui concerne les systèmes à sécurité biologique, voir le chapitre "Anhang/Appendix, Rotoren und Zubehör/Rotors and accessories". Dans le doute vous pouvez obtenir les informations auprès du fabricant.

Couvercle avec fermeture à vis et poignée rotative

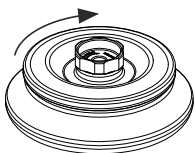

- Poser le couvercle sur le rotor, au centre.
- Fermez bien le couvercle, en tournant à la main la poignée rotative dans le sens des aiguilles d'une montre.

15 Éléments de commande et d'affichage

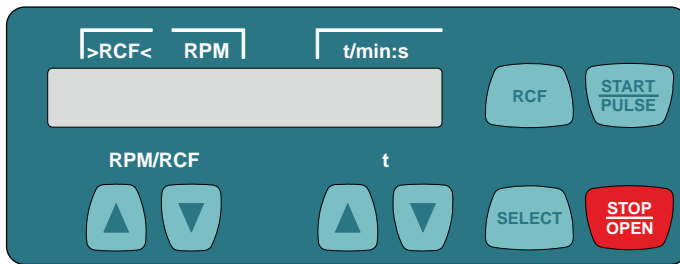

15.1 Pictogrammes



Couvercle déverrouillé.



Couvercle verrouillé.



Affichage de la rotation. L'affichage de rotation brille en tournant dans le sens inverse des aiguilles d'une montre tant que le rotor tourne.

15.2 Touches du champ de commande

RPM/RCF



- Saisir directement la vitesse de rotation.
- Pour faire défiler plus rapidement les valeurs, maintenez la touche enfoncée.

t



- Saisir directement la durée de fonctionnement.
- Réglable en étapes de 1 seconde jusqu'à 1 minute et en étapes de 1 minute à partir de 1 minute.
- Saisir les paramètres de centrifugation.

Pour faire défiler plus rapidement les valeurs, maintenez la touche enfoncée.



- Touche de sélection de chaque paramètre.
- Chaque pression supplémentaire de la touche permet de sélectionner le paramètre suivant.
- Appeler "MACHINE MENU" (appuyer sur la touche pendant 8 secondes).
- Dans "Machine Menu", sélectionner les menus "→ Info", "→ Settings" et "→ Time & Cycles".
- Faire défiler les menus vers l'avant.



- Passer de l'affichage RPM (RPM) à l'affichage RCF (>RCF<) et inversement.

Les valeurs RCF s'affichent entre parenthèses ><.
RPM: vitesse de rotation
RCF : accélération centrifuge relative



- Lancer le cycle de centrifugation.
- Cycle de centrifugation court.
- Le cycle de centrifugation tourne tant que vous appuyez la touche.
- Appeler les menus "→ Info", "→ Settings" et "→ Time & Cycles".



- Terminer le cycle de centrifugation.
- Le rotor s'arrête avec le niveau de freinage présélectionné.
- Appuyer deux fois la touche pour déclencher l'arrêt d'urgence.
- Déverrouiller le couvercle.

15.3 Réglages possibles

t/min **Durée de fonctionnement.** Réglable de 1 à 99 min, en étapes de 1 minute.

t/sec **Durée de fonctionnement.** Réglable de 1 à 59 s, en étapes de 1 seconde.

Fonctionnement continu "--:--". Mettre les paramètres **t/min** et **t/sec** sur zéro.

RPM **Vitesse de rotation**

Vous pouvez saisir une valeur numérique pour paramétrer un régime de 200 RPM jusqu'à vitesse maximum du rotor.

Réglable de 200 RPM jusqu'à 10000 RPM en étapes de 10, et à partir de 10000 RPM en étapes de 100.

Vitesse maximum du rotor, voir chapitre "Annexe/Appendix, rotors et accessoires/Rotors and accessories".

›RCF< **Accélération centrifuge relative**

Vous pouvez saisir une valeur numérique pour paramétrer un régime de 200 RPM jusqu'à vitesse maximum du rotor.

Réglable jusqu'à 10000 en étapes de 1, et à partir de 10000 en étapes de 10.



La saisie des données pour l'accélération centrifuge relative (RCF) n'est possible que si l'affichage RCF (›RCF<) est sélectionné.

L'accélération centrifuge relative (RCF) dépend du rayon de centrifugation (RAD). Après saisie des données de RCF, vérifier que le rayon de centrifugation réglé soit correct.

RAD/mm **Rayon de centrifugation**

Réglable de 10 mm à 250 mm, en étapes de 1 millimètre.

Rayon de centrifugation, voir chapitre "Annexe/Appendix, rotors et accessoires/Rotors and accessories".







La saisie du rayon de centrifugation n'est possible que si l'affichage RCF (›RCF<) est sélectionné.

↵_DEC **Niveau de freinage.** **fast** = temps d'arrêt court, **slow** = temps d'arrêt long.

16 Saisir les paramètres de centrifugation

16.1 Saisie directe des paramètres de centrifugation

Vous pouvez saisir directement la vitesse de rotation (RPM), l'accélération centrifuge relative (RCF), le rayon de centrifugation (RAD) et la durée de fonctionnement avec les touches   sans devoir appuyer préalablement la touche .

 Les paramètres de centrifugation réglés ne sont enregistrés qu'après démarrage du cycle de centrifugation.

16.1.1 Vitesse de rotation (RPM)



- Au besoin, appuyez la touche pour sélectionner l'affichage de RPM.

Exemple :

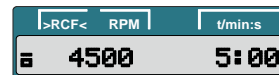

- Réglez la valeur souhaitée avec les touches.

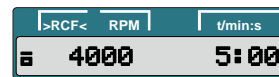

16.1.2 Accélération centrifuge relative (RCF) et rayon de centrifugation (RAD)



- Au besoin, appuyez la touche pour sélectionner l'affichage RCF (>RCF<).

Exemple :



- Régler la valeur RCF souhaitée avec les touches.

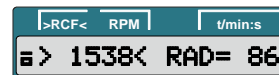

- Au besoin, réglez le rayon de centrifugation souhaité avec les touches.

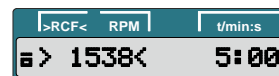
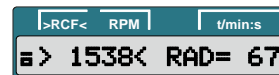

16.1.3 Durée de fonctionnement



Vous pouvez régler la durée de fonctionnement jusqu'à 1 minute en étapes de 1 seconde, mais à partir de 1 minute, seulement en étapes de 1 minute.

Pour régler fonctionnement continu, il faut mettre les paramètres **t/min** et **t/sec** sur zéro. L'affichage temps (t/min:s) indique "--:--".

Exemple:

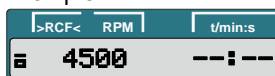

Exemple :



- Réglez la valeur souhaitée avec les touches.



16.2 Saisie des paramètres de centrifugation avec la touche "SELECT"



Vous pouvez régler la durée de fonctionnement en minutes et secondes (paramètres **t/min** et **t/sec**).

Pour tourner en fonctionnement continu il faut mettre les paramètres **t/min** et **t/sec** sur zéro. L'affichage temps (t/min:s) indique "--:--".

Exemple:





L'accélération centrifuge relative (RCF) dépend du rayon de centrifugation (RAD).

Pendant la saisie des données de l'accélération RCF, le rayon de centrifugation configuré s'affiche..

Si, après ou pendant la saisie de paramètres, vous n'appuyez pas de touche pendant 8 secondes, les paramètres précédents réapparaissent. Vous devez alors recommencer la saisie des paramètres.

Appuyer sur la touche  pour enregistrer les réglages.

Si vous saisissez plusieurs paramètres, n'appuyez la touche  qu'après avoir entré le dernier paramètre.

Vous pouvez à tout moment interrompre la saisie des paramètres en appuyant la touche . Auquel cas, les réglages ne seront pas enregistrés.

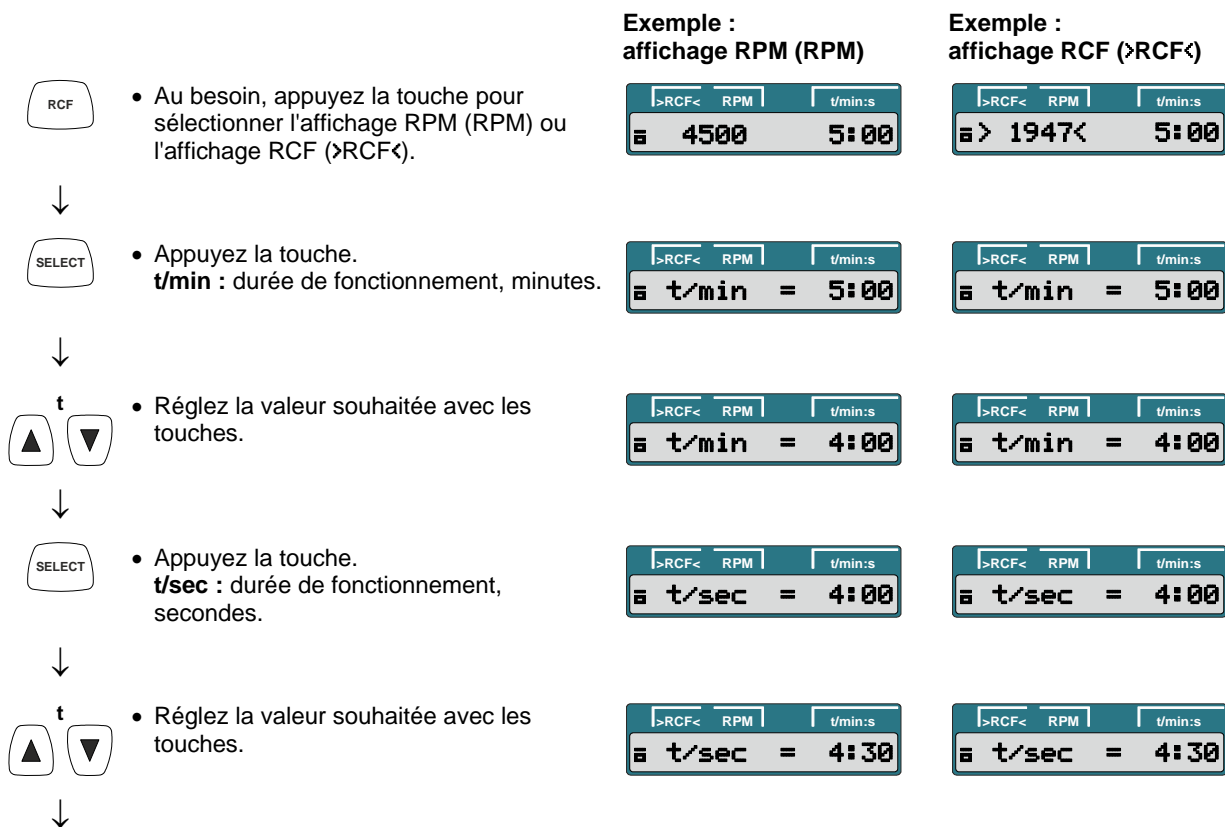

Suite page suivante



- Appuyez la touche.
RPM : vitesse de rotation (rotation par minute).
RAD/mm : rayon de centrifugation.
 L'affichage et la saisie du rayon de centrifugation n'est possible que si l'affichage RCF (>RCF<) est sélectionné.



- Réglez la valeur souhaitée avec les touches.



- Appuyez la touche.
R : rayon de centrifugation.
RCF : accélération centrifuge relative.

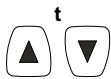

- Réglez la valeur souhaitée avec les touches.



- Appuyez la touche.
_DEC : niveau de freinage.
fast : temps d'arrêt court.
slow : temps d'arrêt long.



- Réglez la valeur souhaitée avec les touches.



- Appuyer sur la touche pour enregistrer les.

Exemple : affichage RPM (RPM)

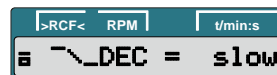

Exemple : affichage RCF (>RCF<)

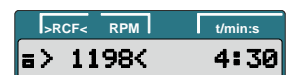
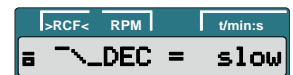
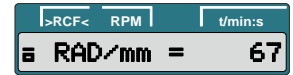
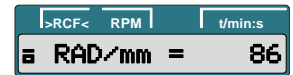

17 Centrifugation



Pendant un cycle de centrifugation, conformément à la norme européenne/ IEC 61010-2-020, veuillez à ce que personne, ni substance dangereuse ni objet, ne se trouve dans la zone de sécurité de 300 mm autour de la centrifugeuse.



Après le cycle de centrifugation, pendant le déverrouillage du couvercle, le nombre de cycles de centrifugation restants s'affiche brièvement.

Exemple :



En cas de dépassement de la différence de poids autorisée pour la charge du rotor, le cycle de centrifugation est interrompu au démarrage et le message suivant apparaît :



Vous pouvez à tout moment interrompre un cycle de centrifugation en appuyant la touche .

Vous pouvez sélectionner et modifier les paramètres de centrifugation pendant un cycle de centrifugation. Toutefois, les valeurs modifiées dans ces conditions ne s'appliqueront qu'au cycle de centrifugation en cours, elles ne seront pas enregistrées.

Avec la touche , vous pouvez à tout moment commuter entre l'affichage RPM (RPM) et l'affichage RCF (>RCF<). Pour travailler avec l'affichage RCF (>RCF<), il faut saisir les données du rayon de centrifugation.

Si le message suivant s'affiche,



cela signifie que vous ne pourrez continuer à utiliser la centrifugeuse qu'après ouverture du couvercle.

Erreurs de commande et dérangements s'affichent (voir chapitre "Dérangements").

- Allumer l'interrupteur de réseau. Position du commutateur I.
- Charger le rotor et fermer le couvercle de la centrifugeuse.

17.1 Centrifugation avec présélection temps



- Au besoin, appuyez la touche pour sélectionner l'affichage RPM (RPM) ou l'affichage RCF (>RCF<).



- Saisir les paramètres de centrifugation souhaités (voir chapitre "Saisir les paramètres de centrifugation").



- Appuyez la touche pour lancer le cycle de centrifugation. Pendant le cycle de centrifugation, l'écran affiche la vitesse de rotation du rotor ou la valeur RCF en résultant, ainsi que le temps restant.





Suite page suivante

Exemple :
affichage RPM (RPM)

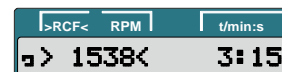
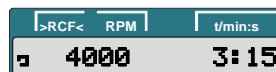
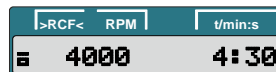
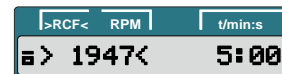

Exemple :
affichage RCF (>RCF<)



- A échéance du temps paramétré ou en cas d'arrêt du cycle de centrifugation avec la touche , l'arrêt se déclenche avec le niveau de freinage paramétré. Le niveau de freinage s'affiche. Exemple 

Exemple :
affichage RPM (RPM)

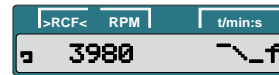

Exemple :
affichage RCF (>RCF<)

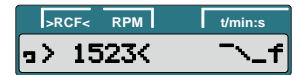

Fonctionnement
continu



- Au besoin, appuyez la touche pour sélectionner l'affichage RPM (RPM) ou l'affichage RCF (>RCF<).



- Saisir les paramètres de centrifugation souhaités. Mettre les paramètres **t/min** et **t/sec** sur zéro (voir chapitre "Saisir les paramètres de centrifugation").



- Appuyez la touche pour lancer le cycle de centrifugation. Pendant le cycle de centrifugation, l'écran affiche la vitesse de rotation du rotor ou la valeur RCF en résultant, ainsi que le temps écoulé.



- Appuyez la touche pour terminer le cycle de centrifugation. L'arrêt se déroule avec le niveau de freinage réglé. Le niveau de freinage s'affiche. Exemple 

Exemple :
affichage RPM (RPM)



Exemple :
affichage RCF (>RCF<)

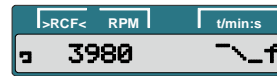

17.2 Cycle de centrifugation court



- Au besoin, appuyez la touche pour sélectionner l'affichage RPM (RPM) ou l'affichage RCF (>RCF<).



- Saisir les paramètres de centrifugation souhaités (voir chapitre "Saisir les paramètres de centrifugation").



- Appuyez la touche et maintenez la enfoncée.
Pendant le cycle de centrifugation, l'écran affiche la vitesse de rotation du rotor ou la valeur RCF en résultant, ainsi que le temps écoulé.



- Relâchez la touche pour terminer le cycle de centrifugation.
L'arrêt se déroule avec le niveau de freinage réglé. Le niveau de freinage s'affiche. Exemple \sim_f .

Exemple : affichage RPM (RPM)

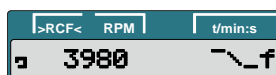
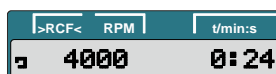
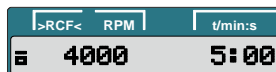
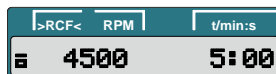

Exemple : affichage RCF (>RCF<)

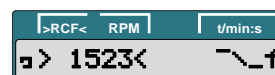
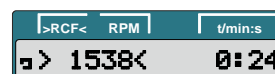
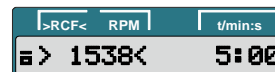
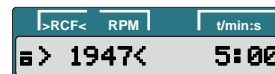

18 Arrêt d'urgence



- Appuyez la touche deux fois.
En cas d'arrêt d'urgence, l'arrêt se déroule avec le niveau de freinage "fast" (temps d'arrêt court). Le niveau de freinage \sim_f s'affiche.

Exemple : affichage RPM (RPM)



Exemple : affichage RCF (>RCF<)

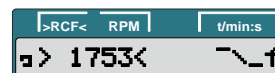

19 Compteur de cycles

 La durée d'utilisation du rotor est limitée à 50000 cycles de centrifugation.

La centrifugeuse est équipée d'un compteur qui compte les cycles de centrifugation.

Après chaque cycle de centrifugation, pendant le déverrouillage du couvercle, le nombre de cycles de centrifugation restants s'affiche brièvement.

Exemple :

```
>RCF< RPM | t/min:s
RemCycles= 16703
```

Lorsque le nombre maximum de cycles autorisé pour le rotor est atteint, l'écran affiche le message suivant à chaque démarrage d'un cycle de centrifugation, et vous devez relancer le cycle.

```
>RCF< RPM | t/min:s
Cycles Passed
```



Si le message suivant s'affiche,

```
>RCF< RPM | t/min:s
Cycles Passed
```

remplacer immédiatement le rotor par un neuf pour des raisons de sécurité.

Après remplacement du rotor, remettre le compteur de cycles sur "0" (voir chapitre "Remettre compteur de cycles à "0").

20 Réglages et demandes

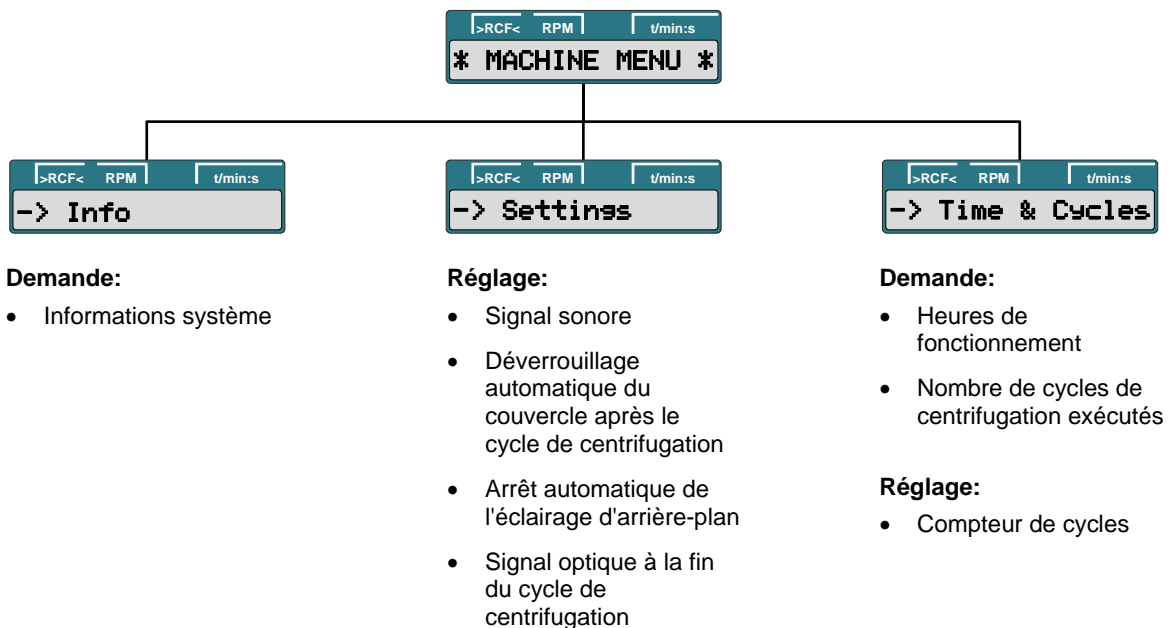



20.1 Demander des informations sur le système

Vous pouvez demander les informations-système suivantes:

- Modèle d'appareil et sa vitesse de rotation maximale,
- Version du programme de l'appareil,
- numéro du type de l'appareil,
- Date de fabrication de l'appareil,
- Numéro de série de l'appareil,
- type du convertisseur de fréquence,
- version du programme du convertisseur de fréquence

Lorsque le rotor est à l'arrêt, procédez comme suit pour vos demandes d'informations:

 Vous pouvez à tout moment interrompre la procédure en appuyant la touche .



- Appuyez la touche pendant 8 secondes.



- Appuyez la touche.



- Appuyez la touche.
Modèle d'appareil et sa vitesse de rotation maximale.

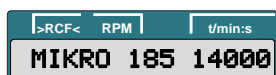

- Appuyez la touche.
Version du programme de l'appareil.

Exemple:

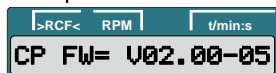

- Appuyez la touche.
Type#1 : numéro du type de l'appareil.

Exemple:



- Appuyez la touche.
Type#2 : suite du numéro du type s'il a plus de positions que le champ d'affichage "**Type#1**".

Exemple:



- Appuyez la touche.
Date de fabrication de l'appareil.

Exemple:



Suite page suivante



- Die Taste drücken.
Numéro de série de l'appareil.

Exemple:

>RCF<	RPM	t/min:s
Serial#: 0016234		



- Appuyez la touche.
Type du convertisseur de fréquence.

Exemple :

>RCF<	RPM	t/min:s
FC type LC 300VA		



- Appuyez la touche.
Version du programme du convertisseur de fréquence.

Exemple :

>RCF<	RPM	t/min:s
FC FW= D 1.04		



- Appuyez deux fois la touche pour quitter le menu
"-> Info" ou trois fois pour quitter le
"*MACHINE MENU*".

Exemple :

>RCF<	RPM	t/min:s
* MACHINE MENU *		

>RCF<	RPM	t/min:s
⚡	4500	5:00



20.2 Signal sonore

























Le signal sonore retentit:

- en intervalles de 2 secondes en cas de dérangement.
- en intervalles de 30 secondes une fois le cycle de centrifugation terminé et le rotor arrêté.

Appuyez n'importe quelle touche pour arrêter le signal sonore.

Lorsque le rotor est à l'arrêt, vous pouvez régler le signal sonore en procédant comme suit :

 Vous pouvez à tout moment interrompre la procédure en appuyant la touche . Auquel cas, les réglages ne seront pas pris en compte.

	• Appuyez la touche pendant 8 secondes.		
↓			
	• Appuyez sur la touche jusqu'à affichage de l'écran suivant.		
↓			
	• Appuyez la touche. End beep : Signal sonore à la fin du cycle de centrifugation. off : signal désactivé. on : signal activé.		
↓			
	• Sélectionnez off (Arrêt) ou on (Marche) avec les touches.		
↓			
	• Appuyez la touche. Error beep : signal sonore dès apparition d'un dérangement. off : signal désactivé. on : signal activé.		
↓			
	• Sélectionnez off (Arrêt) ou on (Marche) avec les touches.		
↓			
	• Appuyez la touche. Beep volume : volume du signal sonore. min : bas mid : moyen max : fort		
↓			
↓			
	• Sélectionnez min , mid , ou max avec les touches.		
↓			

Suite page suivante



- Appuyez la touche pour enregistrer le réglage.

```
>RCF< RPM | t/min:s
Store settings...
```

```
>RCF< RPM | t/min:s
-> Settings
```



- Appuyez cette touche une fois pour quitter le menu "-> Settings" ou deux fois pour quitter le "* MACHINE MENU *".

```
>RCF< RPM | t/min:s
* MACHINE MENU *
```

Exemple :

```
>RCF< RPM | t/min:s
4500 5:00
```

20.3 Signal optique à la fin du cycle de centrifugation

A la fin du cycle de centrifugation, l'éclairage en arrière-plan de l'affichage clignote pour vous signaler optiquement que le cycle de centrifugation est terminé.

Lorsque le rotor est à l'arrêt, vous pouvez activer ou désactiver le signal optique comme suit:



Vous pouvez à tout moment interrompre la procédure en appuyant la touche



- Appuyez la touche pendant 8 secondes.

```
>RCF< RPM | t/min:s
* MACHINE MENU *
```



- Appuyez sur la touche jusqu'à affichage de l'écran suivant.

```
>RCF< RPM | t/min:s
-> Settings
```



- Appuyez la touche.

```
>RCF< RPM | t/min:s
End beep =off
```

```
>RCF< RPM | t/min:s
End beep =on
```



- Appuyez sur la touche jusqu'à affichage de l'un des deux écrans.
End blinking : clignotement de l'éclairage d'arrière-plan après le cycle de centrifugation.
off : l'éclairage d'arrière-plan ne clignote pas.
on : l'éclairage d'arrière-plan clignote.

```
>RCF< RPM | t/min:s
End blinking=off
```

```
>RCF< RPM | t/min:s
End blinking=on
```



- Sélectionnez **off** (Arrêt) ou **on** (Marche) avec les touches.

```
>RCF< RPM | t/min:s
End blinking=off
```

```
>RCF< RPM | t/min:s
End blinking=on
```



- Appuyez la touche pour enregistrer le réglage.

```
>RCF< RPM | t/min:s
Store settings...
```

```
>RCF< RPM | t/min:s
-> Settings
```



- Appuyez cette touche une fois pour quitter le menu "-> Settings" ou deux fois pour quitter le "* MACHINE MENU *".

```
>RCF< RPM | t/min:s
* MACHINE MENU *
```

Exemple :

```
>RCF< RPM | t/min:s
4500 5:00
```



















20.4 Déverrouillage automatique du couvercle après le cycle de centrifugation

Vous pouvez paramétrer si le couvercle doit se déverrouiller automatiquement ou pas après le cycle de centrifugation.

Lorsque le rotor est à l'arrêt, vous pouvez procéder comme suit pour ce faire:





Vous pouvez à tout moment interrompre la procédure en appuyant la touche . Auquel cas, les réglages ne seront pas pris en compte.

	<ul style="list-style-type: none"> Appuyez la touche pendant 8 secondes. 		
↓			
	<ul style="list-style-type: none"> Appuyez sur la touche jusqu'à affichage de l'écran suivant. 		
↓			
	<ul style="list-style-type: none"> Appuyez la touche. 		
↓			
	<ul style="list-style-type: none"> Appuyez sur la touche jusqu'à affichage de l'un des deux écrans. Lid AutoOpen : déverrouillage automatique du couvercle après le cycle de centrifugation. off : pas de déverrouillage automatique du couvercle. on : déverrouillage automatique du couvercle. 		
↓			
	<ul style="list-style-type: none"> Sélectionnez off ou on avec les touches. 		
↓			
	<ul style="list-style-type: none"> Appuyez la touche pour enregistrer le réglage. 		
			
↓			
	<ul style="list-style-type: none"> Appuyez cette touche une fois pour quitter le menu "-> Settings" ou deux fois pour quitter le "* MACHINE MENU *". 		<p>Exemple :</p> 

20.5 Eclairage d'arrière-plan de l'affichage

Pour économiser de l'énergie, vous pouvez paramétrer si, après un cycle de centrifugation, l'éclairage d'arrière-plan de l'affichage doit s'éteindre au bout de 2 minutes.

Lorsque le rotor est à l'arrêt, vous pouvez procéder comme suit pour ce faire:

 Vous pouvez à tout moment interrompre la procédure en appuyant la touche . Auquel cas, les réglages ne seront pas pris en compte.

 • Appuyez la touche pendant 8 secondes.

 • Appuyez sur la touche jusqu'à affichage de l'écran suivant.

 • Appuyez la touche.













 • Appuyez sur la touche jusqu'à affichage de l'un des deux écrans.
Power save : arrêt automatique de l'éclairage d'arrière-plan.
off : arrêt automatique désactivé.
on : arrêt automatique activé.

 • Sélectionnez **off** (Arrêt) ou **on** (Marche) avec les touches.

 • Appuyez la touche pour enregistrer le réglage.

 • Appuyez cette touche une fois pour quitter le menu "→ Settings" ou deux fois pour quitter le "* MACHINE MENU *".

Exemple :



20.6 Demander les heures de fonctionnement et le nombre de cycles de centrifugation

Les heures de fonctionnement sont réparties en heures de service internes et externes.

Heures de service internes: durée totale pendant laquelle l'appareil était enclenché.

Heures de service externes: durée totale des cycles de centrifugation effectués jusque maintenant.

Lorsque le rotor est à l'arrêt, procédez comme suit pour vos demandes d'informations:

 Vous pouvez interrompre à tout moment en appuyant la touche .



- Appuyez la touche pendant 8 secondes.

>RCF<	RPM	t/min:s
* MACHINE MENU *		



- Appuyez sur la touche jusqu'à affichage de l'écran suivant.

>RCF<	RPM	t/min:s
-> Time & Cycles		



- Appuyez la touche.
TimeExt : heures de service externes.

Exemple :

>RCF<	RPM	t/min:s
TimeExt=		43 h



- Appuyez la touche.
TimeInt : heures de service internes.

Exemple :

>RCF<	RPM	t/min:s
TimeInt=		60 h



- Appuyez la touche.
Starts : nombre total des cycles de centrifugation.

Exemple :

>RCF<	RPM	t/min:s
Starts=		325



- Appuyez la touche deux fois pour quitter le menu
"-> Time & Cycles" ou trois fois pour quitter le "* MACHINE MENU *".

>RCF<	RPM	t/min:s
* MACHINE MENU *		

Exemple :

>RCF<	RPM	t/min:s
6	4500	5:00

20.7 Remettre le compteur de cycles à zéro

Après remplacement du rotor, il faut remettre le compteur de cycles à zéro.



Ne remettez le compteur de cycles à zéro qu'après remplacement de l'ancien rotor par un neuf.

Lorsque le rotor est à l'arrêt, vous pouvez réinitialiser le compteur de cycles comme suit:



Vous pouvez à tout moment interrompre la procédure en appuyant la touche . Auquel cas, les réglages ne seront pas pris en compte.



- Appuyez la touche pendant 8 secondes.



- Appuyez sur la touche jusqu'à affichage de l'écran suivant.



- Appuyez la touche.

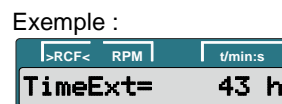

- Appuyez sur la touche jusqu'à affichage de l'écran suivant.
Cyc sum : nombre de cycles effectués.



- Appuyez la touche.



- Appuyez la touche.
Remise à zéro du nombre de cycles effectués.



- Appuyez la touche pour enregistrer le réglage.



- Appuyez la touche deux fois pour quitter le menu
"-> Time & Cycles" ou trois fois pour quitter le "* MACHINE MENU *".



Exemple :

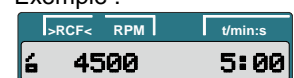

21 Accélération centrifuge relative (RCF)

L'accélération centrifuge relative (RCF) est indiquée en tant que multiple de l'accélération gravitationnelle (g). Il s'agit d'une valeur dépourvue d'unité, qui sert à la comparaison entre la puissance de séparation et de sédimentation.

Le calcul s'effectue à l'aide de la formule suivante:

$$RCF = \left(\frac{RPM}{1000} \right)^2 \times r \times 1,118 \quad \Rightarrow \quad RPM = \sqrt{\frac{RCF}{r \times 1,118}} \times 1000$$

RCF = accélération centrifuge relative

RPM = régime

r = rayon de centrifugation en mm = distance qui sépare le centre de l'axe de rotation du fond de la cuve de centrifugation. Rayon de centrifugation voir chapitre "Anhang/Appendix, Rotoren und Zubehör/Rotors and accessories".



L'accélération centrifuge relative (RCF) est dépendante du régime et du rayon de centrifugation.

22 Centrifugation de matières et de mélanges d'une densité supérieure à 1,2 kg/dm³

Dans le cas de la centrifugation à la vitesse maximale, la densité des substances et des mélanges de substances ne doit pas excéder 1,2 kg/dm³. Réduire la vitesse de rotation pour les matières et mélanges ayant une densité supérieure.

La vitesse de rotation autorisée se calcule de la manière suivante:

$$\text{Vitesse de centrifugation lente (n}_{red}\text{)} = \sqrt{\frac{1,2}{\text{densité supérieure [kg/dm}^3\text{]}}} \times \text{Vitesse de rotation maximum [RPM]}$$

Exemple: Vitesse de rotation maximum RPM 4000, densité 1,6 kg/dm³

$$n_{red} = \sqrt{\frac{1,2 \text{ kg/dm}^3}{1,6 \text{ kg/dm}^3}} \times 4000 \text{ RPM} = 3464 \text{ RPM}$$

En cas d'incertitude, prendre contact avec le fabricant.

23 Déverrouillage de secours

En cas de panne de courant, il est impossible de déverrouiller le couvercle par voie moteur. Il faut donc procéder à un déverrouillage de secours manuel.



Pour un déverrouillage de secours, débranchez la centrifugeuse du réseau.
N'ouvrez le couvercle que si le rotor est à l'arrêt.



PRUDENCE! Lors du déverrouillage de secours, si vous tournez la clé six-pans dans le sens des aiguilles d'une montre (à droite), vous endommagez le verrou.
Ne tournez la clé six-pans que dans le sens inverse des aiguilles d'une montre (vers la gauche), voir illustration.

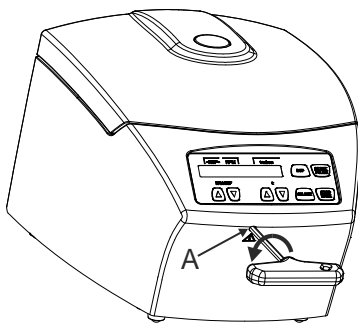

- Débranchez la tension du réseau en mettant l'interrupteur en position "0".
- Vérifiez par la fenêtre du couvercle que le rotor est bien à l'arrêt.
- Insérez la clé six-pans à l'horizontale dans l'ouverture A et tournez la avec précaution dans le sens inverse des aiguilles d'une montre (vers la gauche) jusqu'à ouverture du couvercle.
- Retirez la clé six-pans de l'ouverture.

24 Entretien et maintenance



L'appareil est peut-être contaminé.



Retirer la prise de secteur avant de nettoyer.

Avant d'utiliser une procédure de nettoyage ou de décontamination autre que celle recommandée par le fabricant, l'utilisateur vérifiera auprès du fabricant que la procédure prévue n'endommage pas l'appareil.

- Ne pas nettoyer centrifuges, rotors et accessoires dans un lave-vaisselle.
- Seul le nettoyage manuel et une désinfection liquide sont autorisés.
- La température de l'eau doit être située entre 20 et 25°C.
- Utiliser exclusivement des agents de nettoyage ou de désinfection qui :
 - ont un pH de 5 à 8,
 - ne contiennent pas de substances caustiques, de peroxyde, composés chlorés, acides ni alcalins.
- Respecter impérativement les consignes spéciales d'utilisation données par le fabricant des agents de nettoyage et de désinfection, afin de prévenir la corrosion par les agents de nettoyage et de désinfection.

24.1 Centrifugeuse (boîtier, couvercle et cuve)

24.1.1 Entretien et nettoyage des surfaces

- Nettoyer régulièrement le boîtier de la centrifugeuse et le compartiment de centrifugation et les laver en cas de besoin avec du savon ou un détergent doux et un chiffon humide. Ces opérations sont nécessaires pour garantir l'hygiène et pour prévenir la corrosion par la présence durable d'impuretés.
- Substances des nettoyants adéquats :
savon, agents anioniques et non ioniques.
- Après utilisation des nettoyants, enlevez les résidus en essuyant l'appareil avec un chiffon humide.
- Séchez immédiatement les surfaces après nettoyage.
- Sécher le bol avec un chiffon absorbant en cas de dépôt d'eau de condensation dans le bol de la centrifugeuse.
- Vérifiez tous les ans le bon état de la cuve.



N'utilisez plus la centrifugeuse si elle présente des dommages susceptibles de porter atteinte à la sécurité. Auquel cas, contactez le service après-vente.

24.1.2 Désinfection des surfaces

- Le bol de la centrifugeuse doit être nettoyé immédiatement dans le cas où un matériau infectieux a pénétré dans le bol de la centrifugeuse.
- Substances des désinfectants adéquats :
éthanol, n-propanol, éthylènehexanol, agents anioniques, inhibiteurs de corrosion.
- Après utilisation de désinfectants, enlevez les résidus en essuyant l'appareil avec un chiffon humide.
- Séchez immédiatement les surfaces après désinfection.

24.1.3 Décontamination de substances radioactives

- L'agent employé doit expressément convenir pour une décontamination de substances radioactives.
- Substances des agents adaptés à une décontamination des substances radioactives :
agents anioniques, non ioniques agents, éthanol polyhydre.
- Après décontamination des substances radioactives, enlevez les résidus en essuyant l'appareil avec un chiffon humide.
- Séchez immédiatement les surfaces après décontamination des substances radioactives.

24.2 Rotors et accessoires

24.2.1 Nettoyage et entretien

- Afin de prévenir la corrosion et toute modification des matériaux, il faut nettoyer régulièrement les rotors et les accessoires avec du savon ou un détergent doux et un chiffon humide. Il est vivement recommandé d'effectuer un nettoyage au moins une fois par semaine. Enlevez immédiatement les impuretés.
- Substances des nettoyeurs adéquats :
savon, agents anioniques et non ioniques.
- Après utilisation de nettoyeurs, enlevez les résidus en rinçant à l'eau claire (uniquement à l'extérieur de la centrifugeuse) ou en essuyant les surfaces avec un chiffon humide.
- Séchez rotors et accessoires immédiatement après nettoyage.
- Dans le cas des systèmes à sécurité biologique (Pour ce qui concerne les systèmes à sécurité biologique, voir le chapitre "Anhang/Appendix, Rotoren und Zubehör/Rotors and accessories") il faut contrôler et nettoyer les bagues d'étanchéité régulièrement (toutes les semaines). Changer immédiatement la bague d'étanchéité si elle présente des marques de fissuration, de friabilité et d'usure. Pour éviter de fausser la bague d'étanchéité en ouvrant et en fermant le couvercle, il faut frotter légèrement la bague d'étanchéité avec de la poudre de talc ou un produit d'entretien pour caoutchouc.
- Déposer le rotor au moins une fois par mois, nettoyer et enduire l'arbre d'entraînement d'une pellicule de graisse pour prévenir la corrosion par la présence d'humidité entre le rotor et l'arbre d'entraînement.
- Contrôler les rotors et les accessoires une fois par mois pour déceler d'éventuels symptômes d'usure ou des dégâts de corrosion.



Les rotors et les accessoires usés et endommagés par la corrosion ne doivent plus être utilisés.

- Vérifier chaque semaine la stabilité de fixation du rotor.

24.2.2 Désinfection

- Si les rotors ou accessoires sont infectés, procédez à une désinfection appropriée.
- Substances des désinfectants adéquats :
éthanol, n-propanol, éthylènehexanol, agents anioniques, inhibiteurs de corrosion.
- Après utilisation de désinfectants, enlevez les résidus en rinçant à l'eau claire (uniquement à l'extérieur de la centrifugeuse) ou en essuyant les surfaces avec un chiffon humide.
- Séchez rotors et accessoires immédiatement après désinfection.

24.2.3 Décontamination de substances radioactives

- L'agent employé doit expressément convenir pour une décontamination de substances radioactives.
- Substances des agents adaptés à une décontamination des substances radioactives :
agents anioniques, agents non ioniques, éthanol polyhydre.
- Après décontamination des substances radioactives, enlevez les résidus en rinçant à l'eau claire (uniquement à l'extérieur de la centrifugeuse) ou en essuyant les surfaces avec un chiffon humide.
- Séchez immédiatement rotors et accessoire après décontamination des substances radioactives.

24.2.4 Rotors et accessoires à durée d'utilisation limitée

La durée d'utilisation des rotors est limitée à un certain nombre de cycles (courses de centrifugation). Le nombre maximum de cycles autorisés est indiqué sur le rotor.



Pour des raisons de sécurité, l'utilisation du rotor n'est plus autorisée dès que le nombre maximum de cycles spécifiés est atteint.

L'appareil est équipé d'un compteur qui compte les cycles de centrifugation. Description voir chapitre "Compteur de cycles".

24.3 Autoclave



Les rotors peuvent être stérilisés en autoclave à 121°C / 250°F (20 min).

Pour des raisons de sécurité, il faut remplacer le rotor après 10 stérilisations par autoclave.

Après stérilisation en autoclave, attendre que le rotor ait refroidi à température ambiante avant de le réutiliser.

Nous ne pouvons faire aucune déclaration sur le degré de stérilisation.



Avant l'autoclavage, déposer le couvercle des rotors et du récipient.

La stérilisation en autoclave accélère le processus de vieillissement des matières plastiques. Elle peut également modifier la couleur des plastiques.

24.4 Réservoirs de centrifugation

- En cas de fuite ou de rupture de récipients de centrifugation, il faut éliminer tous les morceaux de récipients cassés, les fragments de verre et les substances centrifugées écoulées.
- Les amortisseurs antivibrations ainsi que les caoutchouc intermédiaires des rotors doivent être remplacés après un bris de verre.



Les fragments de verre restants peuvent entraîner d'autres bris de verre !



- S'il s'agit d'un matériau infectieux, exécuter immédiatement une désinfection.

25 Défauts

Si l'erreur ne peut pas être éliminée d'après le tableau des défauts, il faut alors avertir le service après-vente. Veuillez indiquer le type de centrifuge et le numéro de série. Les deux numéros sont indiqués sur la plaque signalétique de la centrifugeuse.

 Effectuer une RÉINITIALISATION DU SECTEUR :

- Couper l'interrupteur de secteur (position de l'interrupteur "0").
- Attendre au moins 10 secondes et refermer ensuite l'interrupteur de secteur (position de l'interrupteur "I").

Message / Erreur		Origine	Solution
Pas d'affichage		Pas de tension Défaut des fusibles sur l'entrée de secteur.	<ul style="list-style-type: none"> - Vérifier l'alimentation en tension. - Vérifier les fusibles d'entrée du secteur, voir au chapitre "Changer les fusibles d'entrée de secteur". - Interrupteur du secteur sur MARCHE
IMBALANCE		Le rotor est chargé de manière non symétrique.	<ul style="list-style-type: none"> - Ouvrez le couvercle lorsque le rotor est arrêté. - Vérifier le chargement du rotor, voir au chapitre "Chargement du rotor". - Répéter le cycle de centrifugation.
MAINS INTER	11	Interruption du secteur pendant le cycle de centrifugation. (Le cycle de centrifugation n'est pas terminé.)	<ul style="list-style-type: none"> - Ouvrez le couvercle lorsque le rotor est arrêté. - Appuyer sur la touche . - En cas de besoin, répéter le cycle de centrifugation.
MAINS INTERRUPT			
TACHO ERROR	1, 2	Défaillance des impulsions de rotation pendant une opération.	<ul style="list-style-type: none"> - Effectuer une RÉINITIALISATION DU SECTEUR après l'immobilisation du rotor.
LID ERROR	4.1 – 4.127	Erreur du verrouillage ou de la fermeture du capot.	
OVER SPEED	5	Survitesse	
VERSION ERROR	12	Modèle de centrifugeuse détecté incorrect. Défaut / Panne de l'électronique.	<ul style="list-style-type: none"> - Effectuer une RÉINITIALISATION DU SECTEUR après l'immobilisation du rotor.
UNDER SPEED	13	Vitesse trop basse	
CTRL ERROR	22.1, 25.2	Défaut / Panne de l'électronique.	
CRC ERROR	27.1		
COM ERROR	31 – 36		
FC ERROR	60, 61.1 – 61.21, 61.64 – 61.142		
FC ERROR	61.23	Vitesse de rotation mesurée erronée	<ul style="list-style-type: none"> - N'éteignez pas l'appareil tant qu'une rotation est signalée par témoin lumineux . Attendez que le symbole  (couvercle verrouillé) s'affiche (au bout de 120 secondes environ). Exécutez ensuite une RÉINITIALISATION DU SECTEUR.
TACHO ERR	61.22		
FC ERROR	61.153	Défaut / Panne de l'électronique.	<ul style="list-style-type: none"> - Effectuer une RÉINITIALISATION DU SECTEUR. - Vérifier le chargement du rotor, voir au chapitre "Chargement du rotor". - Répéter le cycle de centrifugation.

26 Changer les fusibles d'entrée de secteur



Déclencher l'interrupteur de secteur et couper l'appareil du réseau!

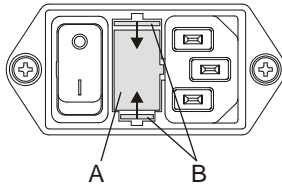

Le porte-fusible (A) avec les fusibles d'entrée de secteur se trouve à côté de l'interrupteur secteur.

- Retirer le câble de raccordement de la prise d'appareil.
- Appuyer la fermeture rapide (B) contre le porte-fusible (A) et extraire celui-ci.
- Remplacer les fusibles d'entrée du réseau défectueux.



N'utilisez que des fusibles avec la valeur nominale, fixée pour le type, voir tableau suivant.

- Remettre en place le porte-fusible et pousser jusqu'à encastrement de la fermeture rapide.
- Rebrancher l'appareil sur le réseau.

Modèle	Type	Fusible	N° de commande
MIKRO 185	1203	T 3,15 AH/250V	E997
MIKRO 185	1203-01	T 6,3 AH/250V	2266

27 Renvoi d'appareils au fabricant



Avant de renvoyer l'appareil, il faut monter le dispositif de fixation pour le transport.

Dans le cas où l'appareil ou ses accessoires doivent être retournés à la société Andreas Hettich GmbH & Co. KG, il faut les décontaminer et les nettoyer avant expédition, dans le but d'assurer la protection des personnes, de l'environnement et du matériel.

Nous nous réservons le droit de refuser des appareils ou des accessoires contaminés.

Nous facturons au client les frais de nettoyage et de désinfection.

Vous voudrez bien manifester votre compréhension pour cette réglementation.

28 Élimination des déchets

Avant de mettre l'appareil au rebut, vous devez le décontaminer et le nettoyer pour la protection des personnes, de l'environnement et du matériel.

Les dispositions légales en vigueur doivent être respectées lors de l'élimination de l'appareil.

Conformément à la directive 2002/96/CE (WEEE), tous les appareils livrés après le 13.08.2005 ne doivent plus être jetés avec les déchets ménagers. L'appareil fait partie du groupe 8 (dispositifs médicaux) et est classé dans le domaine "Business-to-Business".



Le symbole de la poubelle barrée d'une croix indique que l'appareil ne doit pas être jeté avec les déchets ménagers.

Les dispositions relatives à l'élimination des déchets des différents pays de l'UE peuvent varier. Veuillez-vous adresser en cas de besoin à votre fournisseur.

Indice

1	Impiego di queste istruzioni per l'uso.....	110
2	Significato dei simboli	110
3	Conformità di impiego.....	110
4	Rischi residui	110
5	Dati tecnici.....	111
6	Indicazioni inerenti la sicurezza	112
7	Trasporto ed immagazzinaggio.....	114
7.1	Trasporto	114
7.2	Immagazzinaggio	114
8	Entità di fornitura.....	114
9	Rimuovere il dispositivo di sicurezza per il trasporto	115
10	Messa in funzione	115
11	Aprire e chiudere il coperchio.....	116
11.1	Aprire il coperchio	116
11.2	Chiudere il coperchio	116
12	Montaggio e smontaggio del rotore.....	116
13	Carico del rotore.....	117
14	Chiudere i sistemi biologici di sicurezza.....	117
15	Elementi di comando e di visualizzazione	118
15.1	Simboli esposti.....	118
15.2	Tasti del campo di comando	118
15.3	Possibilità di regolazione	119
16	Immettere il parametro di centrifugazione	120
16.1	Inoltro diretto del parametro di centrifugazione.....	120
16.1.1	Regime di rotazione (RPM).....	120
16.1.2	Accelerazione relativa di centrifuga (RCF) e raggio di centrifugazione (RAD).....	120
16.1.3	Tempo di funzionamento	120
16.2	Inoltro del parametro di centrifugazione con il tasto "SELECT"	121
17	Centrifugazione	123
17.1	Centrifugazione con preselezione del tempo	123
17.2	Funzionamento continuo.....	124
17.3	Centrifugazione breve.....	125
18	Arresto di Emergenza.....	125
19	Contatore cicli	126
20	Impostazioni e consultazioni	126
20.1	Consultare informazioni di sistema	127
20.2	Segnale acustico.....	129
20.3	Segnale ottico dopo la fine del processo di centrifugazione	130
20.4	Sbloccaggio automatico del coperchio dopo il processo di centrifugazione.....	131
20.5	Illuminazione di sfondo della videata	132
20.6	Consultazione delle ore di funzionamento e della quantità di processi di centrifugazione	133
20.7	Resettare su zero il contatore cicli	134
21	Accelerazione centrifuga relativa (RCF).....	135

22	Centrifugazione di sostanze o di miscele di sostanze con densità maggiore di 1,2 kg/dm ³	135
23	Sbloccaggio di emergenza	135
24	Pulizia e manutenzione	136
24.1	Centrifughe (scatola, coperchio e vano di centrifugazione).....	136
24.1.1	Cura e pulizia delle superfici	136
24.1.2	Disinfezione delle superfici	136
24.1.3	Rimuovere contaminazioni radioattive	136
24.2	Rotori ed accessori	137
24.2.1	Pulizia e cura	137
24.2.2	Disinfezione	137
24.2.3	Rimuovere contaminazioni radioattive	137
24.2.4	Rotori ed accessori con limitata durata di impiego.....	137
24.3	Trattamento in autoclave.....	138
24.4	Contenitori centrifuga	138
25	Guasti	139
26	Sostituzione fusibili entrata rete.....	140
27	Rispedizione di apparecchi.....	140
28	Smaltimento	140
29	Anhang / Appendix	141
29.1	Rotoren und Zubehör / Rotors and accessories.....	141

1 Impiego di queste istruzioni per l'uso

- Prima della messa in funzione della centrifuga leggere ed osservare le istruzioni per l'uso.
- Le istruzioni per l'uso sono una componente dell'apparecchiatura. Devono essere custodite in modo da essere sempre accessibili.
- Se l'apparecchiatura viene installata in un altro luogo, questa deve venire accompagnata dalle istruzioni per l'uso.

2 Significato dei simboli



Simbolo sull'apparecchio:

Attenzione, punto pericoloso generico.

Prima di utilizzare l'apparecchiatura leggere in ogni caso le istruzioni per l'uso ed osservare le istruzioni rilevanti per la sicurezza!



Simbolo in questo documento.

Attenzione, punto pericoloso generico.

Questo simbolo contraddistingue le avvertenze relative alla sicurezza e indica situazioni potenzialmente pericolose .

La mancata osservanza di tali avvertenze può causare danni materiali e personali.



Simbolo sull'apparecchiatura ed in questo documento:

Attenzione: rischio biologico.



Simbolo in questo documento:

Questo simbolo indica argomenti importanti.



Simbolo sull'apparecchiatura ed in questo documento:

Simbolo per la raccolta separata delle apparecchiature elettriche ed elettroniche, in conformità alle direttive 2002/96/CEE (WEEE). L'apparecchiatura appartiene al gruppo 8 (apparecchiature medicali).

Impiego nelle nazioni dell'Unione Europea, in Norvegia ed in Svizzera.

3 Conformità di impiego

Per quanto riguarda l'apparecchio in oggetto, si tratta di un prodotto medico (centrifuga di laboratorio) ai sensi della direttiva Diagnostici in vitro (IVD) 98/79/CE.

La centrifuga è stata concepita per separare materiali o miscele di materiali che hanno una densità massima di 1,2 kg/dm³.

Fanno parte di questa classificazione le preparazioni di campioni per le analisi biologiche molecolari nel settore clinico. La centrifugazione è a questo riguardo un passo decisivo nella estrazione e nella purificazione del DNA e RNA dai campioni provenienti da pazienti. Al riguardo vengono utilizzati nella routine diversi corredi speciali. Se vengono utilizzati corredi con Spin columns, la centrifuga soddisfa, tramite un'accelerazione centrifugale di sufficiente entità ed il suo rotore concepito in modo speciale per la centrifugazione di corredi Spin column, i requisiti per la preparazione di campioni nella diagnosi di infezioni.

Le centrifuga è destinata solo a questo scopo d'impiego.

Un diverso od ulteriore tipo di impiego non è regolamentare. La ditta Andreas Hettich GmbH & Co. KG non si prende carico di alcuna responsabilità nel caso di danni da ciò derivanti.

Per l'impiego a norma è previsto anche il rispetto di tutte le avvertenze riportate nelle istruzioni d'uso ed il rispetto degli interventi di ispezione e di manutenzione.

Se la centrifuga viene installata in un'altra apparecchiatura od integrata in un sistema, allora il costruttore del sistema complessivo è responsabile della sicurezza del sistema.

4 Rischi residui

L'apparecchio è costruito secondo lo stato attuale della tecnica e le regole riconosciute riguardanti la tecnica della sicurezza. In caso di uso ed impiego non regolamentari possono insorgere pericoli mortali per l'utilizzatore o per terzi risp. danni all'apparecchio o ad altri beni materiali. L'apparecchio è destinato solo all'uso regolamentare e va utilizzato solo in uno stato perfetto per quanto riguarda la tecnica della sicurezza.

Eventuali anomalie, che possono pregiudicare la sicurezza devono essere immediatamente eliminate.

5 Dati tecnici

Costruttore	Andreas Hettich GmbH & Co. KG D-78532 Tuttlingen	
Modello	MIKRO 185	
Tipo	1203	1203-01
Tensione di rete ($\pm 10\%$)	200 - 240 V 1~	100 - 127 V 1~
Frequenza di rete	50 - 60 Hz	50 - 60 Hz
Potenza assorbita	390 VA	390 VA
Assorbimento di corrente	1.8 A	3.6 A
Capacità max.	24 x 1.5 / 2.0 ml	
Densità permessa	1.2 kg/dm ³	
Regime di rotazione (RPM)	14000	
Accelerazione (RCF)	18845	
Energia cinetica	2450 Nm	
Obbligo di collaudo (BGR 500)	no	
Presupposti ambientali (EN / IEC 61010-1)	solo in interni	
– luogo di installazione	fino a 2000 metri sopra il livello del mare	
– altezza	2°C fino a 40°C	
– temperatura ambiente	umidità relativa massima dell'aria 80% per temperature fino a 31°C, con riduzione lineare fino al 50% dell'umidità relativa per una temperatura di 40°C.	
– umidità dell'aria	II	
– Categoria di sovratensione (IEC 60364-4-443)	2	
– grado di imbrattamento	I	
Classe di protezione	I	
non adatto per l'impiego in ambiente a rischio di esplosione.		
Compatibilità elettromagnetica		
– emissione di radiointerferenze	EN / IEC 61326-1, classe B	FCC Class B
– resistenza alle interferenze		
Livello di emissione acustica (in funzione del rotore)	≤ 59 dB(A)	
dimensioni		
– larghezza	261 mm	
– profondità	353 mm	
– altezza	228 mm	
Peso	ca. 11 kg	

6 Indicazioni inerenti la sicurezza



Se non vengono rispettate tutte le avvertenze riportate in queste istruzioni per il funzionamento, non può essere accettata da parte del costruttore alcuna richiesta di garanzia.



- **La centrifuga deve venire posizionata in modo sicuro.**
- **Prima di utilizzare la centrifuga, è necessario controllare che il rotore sia correttamente in sede.**
- **Durante un'operazione di centrifugazione, in una zona di sicurezza di 300 mm attorno alla centrifuga non deve sostare alcuna persona, materiali pericolosi ed oggetti, in conformità alle norme EN / IEC 61010-2-020.**
- **I rotori, le sospensioni e gli accessori che presentano forti segni di corrosione o danni meccanici, oppure la cui durata d'impiego è scaduta, non devono più essere utilizzati.**
- **Se il vano di centrifugazione presenta danni rilevanti per la sicurezza, la centrifuga non deve essere più messa in funzione.**
- **Nel caso di centrifughe senza regolazione termica, con temperature ambiente elevate e/o con frequente impiego dell'apparecchiatura può presentarsi un riscaldamento del vano di centrifugazione. Per questo motivo non può venire esclusa una modificazione del materiale di prova a causa alla temperatura.**

- **Prima di mettere in funzione la centrifuga si devono leggere ed osservare le istruzioni per l'uso. L'apparecchio può essere utilizzato solo da persone che abbiano letto e compreso le istruzioni d'uso.**
- Oltre alle istruzioni per l'uso, si devono osservare anche i regolamenti, relativi alla protezione antinfortunistica ed i regolamenti tecnici, riconosciuti in materia di sicurezza del lavoro. Le istruzioni per l'uso vanno completate dalle norme nazionali in vigore nel paese d'impiego, relative alla protezione antinfortunistica ed alla tutela ambientale.
- La centrifuga è costruita in base all'attuale livello tecnologico e le regole di sicurezza conosciute. La centrifuga può essere tuttavia fonte di pericolo per l'operatore o per terzi, se non viene utilizzata da personale appositamente addestrato o se viene utilizzata in modo improprio o non conforme alla destinazione.
- Durante l'esercizio bisogna evitare di muovere la centrifuga o di urtarvi contro.
- In caso di guasto, ovvero del ripristino d'emergenza, non si deve assolutamente toccare il rotore.
- Quando la centrifuga passa da un ambiente freddo in uno caldo, per evitare danni dovuti alla condensa, lasciar riscaldare la centrifuga per almeno 3 ore nell'ambiente caldo prima di collegarla alla rete, oppure portare la centrifuga a temperatura d'esercizio mettendola in funzione per 30 minuti nell'ambiente freddo.
- Devono essere utilizzati esclusivamente i rotori e gli accessori omologati per questa apparecchiatura (vedere capitolo "Anhang/Appendix, Rotoren und Zubehör/Rotors and accessories"). Prima di utilizzare contenitori di centrifugazione, che non sono elencati nel capitolo "Appendice/Appendix, Rotori ed accessori/Rotors and accessories", l'utente deve accertarsi presso il costruttore, che questi possano venire utilizzati.
- Il rotore della centrifuga può essere caricato solo in conformità al capitolo " Carico del rotore".
- In caso di centrifugazione con massimo numero di giri, la densità dei materiali o delle miscele di materiali non deve superare il valore di composizione di $1,2 \text{ kg/dm}^3$.
- Non è consentito l'uso di centrifughe non bilanciate in modo regolamentare.
- Non è permesso l'impiego della centrifuga in ambiente a pericolo di esplosione.
- E' proibito l'uso di una centrifuga con:
 - materiali infiammabili od esplosivi
 - materiali che possono reagire chimicamente tra loro con forte energia.

- Se vengono centrifugate sostanze pericolose o miscele di sostanze contaminate da micro organismi tossici, radioattivi o patogeni, l'utente dovrà prendere opportuni provvedimenti in materia.
Si devono fondamentalmente utilizzare contenitori per centrifugazione con tappi a vite speciali per sostanze pericolose. Con materiali dei gruppi di rischio 3 e 4, oltre ai contenitori per centrifugazione chiudibili si deve impiegare un sistema di sicurezza biologico (vedi manuale "Laboratory Biosafety Manual" dell'Organizzazione mondiale per la salute).
In un sistema di sicurezza biologico una guarnizione biologica (anello di guarnizione) impedisce la fuoriuscita delle goccioline e degli aerosol.
Le guarnizioni ad anello danneggiate non possono più essere utilizzate per la chiusura a tenuta del sistema di sicurezza biologico.
Senza l'impiego di un sistema di sicurezza biologico, una centrifuga non è microbiologicamente a tenuta in conformità alla norma EN / IEC 61010-2-020.
Per la chiusura dei sistemi biologici di sicurezza seguire le indicazioni al capitolo "Chiudere i sistemi biologici di sicurezza".
Per quanto riguarda i sistemi biologici di sicurezza fornibili, rimandiamo al capitolo "Anhang/Appendix, Rotoren und Zubehör/Rotors and accessories". Nel dubbio chiedere maggiori informazioni al produttore o importatore.
- Non è consentito il funzionamento della centrifuga con sostanze altamente corrosive che possono pregiudicare la resistenza meccanica dei rotori, delle sospensioni e degli accessori.
- Gli interventi di riparazione devono essere effettuati esclusivamente da una persona autorizzata dal costruttore.
- Devono essere impiegati solo ed esclusivamente pezzi di ricambio originali ed accessori autorizzati della ditta Andreas Hettich GmbH & Co. KG.
- Sono di validità le seguenti norme di sicurezza:
EN / IEC 61010-1 e EN / IEC 61010-2-020 come anche le loro nazionali varianti.
- La sicurezza e l'affidabilità della centrifuga sono garantite solo se:
 - la centrifuga funziona in conformità con le istruzioni per l'uso
 - l'installazione elettrica sul luogo di posizionamento della centrifuga risponde ai requisiti previsti dalla EN / IEC
 - i collaudi che riguardano la sicurezza dell'apparecchiatura e che sono prescritti nei diversi Stati, p.es. in Germania conformemente alle norme BGV A1 e BGR 500, vengono eseguiti da parte di un perito.

7 Trasporto ed immagazzinaggio

7.1 Trasporto



Prima di effettuare il trasporto dell'apparecchiatura deve venire installato il dispositivo di sicurezza per il trasporto.

Per il trasporto dell'apparecchiatura e degli accessori devono venire rispettati i seguenti presupposti di ambiente.

- Temperatura ambiente: -20°C fino a +60°C
- Umidità relativa dell'aria: 20% fino a 80%, non condensante

7.2 Immagazzinaggio



L'immagazzinaggio dell'apparecchiatura e degli accessori è ammesso solo in ambienti chiusi ed asciutti.

Per l'immagazzinaggio dell'apparecchiatura e degli accessori devono essere rispettati i seguenti presupposti di ambiente.

- Temperatura ambiente: -20°C fino a +60°C
- Umidità relativa dell'aria: 20% fino a 80%, non condensante

8 Entità di fornitura

Con la centrifuga vengono forniti i seguenti accessori:

- 1 Cavo di rete
- 2 fusibili
- 1 chiave a brugola esagonale
- 1 Istruzioni per l'uso
- 1 foglio delle istruzioni per il dispositivo di sicurezza per il trasporto
- 1 foglio delle istruzioni per lo sbloccaggio di emergenza

Rotore/i e i corrispondenti accessori vengono forniti in base alla commessa.

9 Rimuovere il dispositivo di sicurezza per il trasporto



Il dispositivo di sicurezza per il trasporto deve venire assolutamente rimosso.

Conservare il dispositivo di sicurezza per il trasporto, poiché prima di un ulteriore trasporto deve venire reinstallato.

Il trasporto dell'apparecchiatura è ammesso solo con dispositivo di sicurezza per il trasporto installato.

Per proteggere l'apparecchiatura durante il trasporto, il motore viene fissato. Questo dispositivo di sicurezza per il trasporto deve venire rimosso al momento della messa in esercizio dell'apparecchiatura.

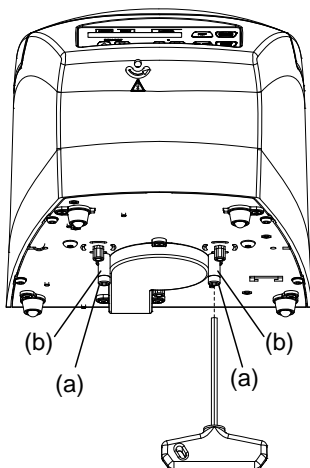

- Rimuovere entrambe le viti (a) e le bussole distanziali (b).



L'installazione del dispositivo di sicurezza per il trasporto avviene nella sequenza inversa.

10 Messa in funzione

- Rimuovere il dispositivo di sicurezza per il trasporto che si trova sul fondo dell'alloggiamento, vedere al capitolo "Rimozione del dispositivo di sicurezza".
- **Porre la centrifuga in un posto adatto e livellarla. Per l'installazione deve essere rispettata la zona di sicurezza di 300 mm attorno alla centrifuga, richiesta in conformità alle norme EN / IEC 61010-2-020**



Durante un'operazione di centrifugazione, in una zona di sicurezza di 300 mm attorno alla centrifuga non deve sostare alcuna persona, materiali pericolosi ed oggetti, in conformità alle norme EN / IEC 61010-2-020.

- Le aperture di ventilazione non devono essere chiuse mettendo oggetti davanti. Rispetto alle feritoie di ventilazione e ad alle aperture di ventilazione della centrifuga deve venir mantenuta una distanza di 300 mm.
- Verificare se la tensione di rete sia adatta all'indicazione riportata nella targhetta con i dati caratteristici.
- Collegare la centrifuga ad una presa di rete standard utilizzando un cavo di rete. Per la potenza massima assorbita, vedere il capitolo "Dati tecnici".
- Inserire l'interruttore di rete (posizione di interruttore "I").
Sul display compare in successione quanto segue:
 1. il modello di centrifuga
 2. il numero del tipo e la versione di programma
 3. i dati di centrifugazione utilizzati da ultimo



Quando il coperchio è chiuso, viene esposto il messaggio "Open the lid".

In questo caso aprire il coperchio, in modo che i dati di centrifugazione vengano esposti.

11 Aprire e chiudere il coperchio

11.1 Aprire il coperchio



Il coperchio si lascia aprire solo, quando la centrifuga è inserita ed il rotore è fermo.
Se ciò non dovesse essere possibile, vedere al capitolo "Sbloccaggio di emergenza".



Quando il contatore cicli è attivato, dopo ogni operazione di centrifugazione e durante l'apertura del coperchio, viene esposta per breve tempo la quantità residua di cicli operativi (operazioni di centrifugazione).

Esempio:



- Premere il tasto.
Il coperchio si sblocca motoricamente.
☑ : Coperchio sbloccato.

Esempio:

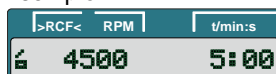

11.2 Chiudere il coperchio



Non intervenire con le dita tra il coperchio e l'alloggiamento.
Non chiudere con violenza il coperchio.

- Adagiare il coperchio e premere leggermente verso il basso il bordo anteriore del coperchio.
Il coperchio si blocca motoricamente.
☑ : Coperchio bloccato.

Esempio:

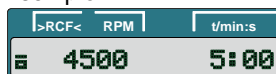

12 Montaggio e smontaggio del rotore

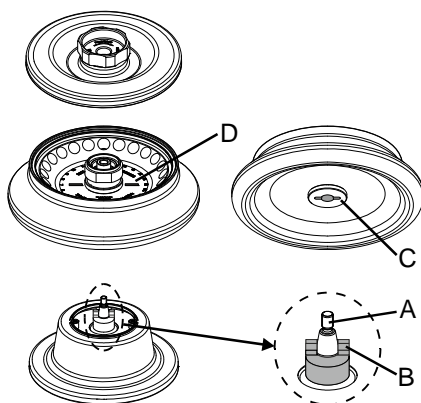

Montaggio:

- Pulire l'albero motore (A) ed il foro del rotore ed ingrassare poi leggermente l'albero motore. Le particelle di sporco tra l'albero motore ed il rotore impediscono un perfetto posizionamento in sede del rotore e sono causa di un irrequieto movimento.
- Applicare verticalmente il rotore sull'albero motore. Il trascinato (B) sull'albero motore deve trovarsi nella scanalatura (C) del rotore. Sul rotore è contrassegnata (D) la direzione della scanalatura.
- Serrare il dado di bloccaggio del rotore utilizzando la chiave a forchetta esagonale che vi è stata fornita e girando in senso orario.
- Controllare che il rotore sia fissato stabilmente.

Smontaggio:

- Sbloccare, girandolo in senso antiorario con la chiave a forchetta esagonale, il dado di bloccaggio del rotore e girare fino al punto di pressione di sollevamento. Dopo aver superato il punto di pressione di sollevamento il rotore si sblocca dal cono dell'albero motore. Girare il dado di bloccaggio, fino a quando il rotore si lascia sollevare dall'albero motore.
- Sollevare il rotore dall'albero motore.

13 Carico del rotore



Lo standard dei recipienti di vetro centrifugati sono da caricare fino a RCF 4000 (DIN 58970 capoverso 2).

- Verificare che il rotore sia fissato.
- I rotori devono essere caricati esclusivamente in modo simmetrico. I recipienti di centrifuga devono essere distribuiti uniformemente su tutti i posti del rotore. Per le combinazioni permesse vedere capitolo "Anhang/Appendix, Rotoren und Zubehör/Rotors and accessories".

Esempio:

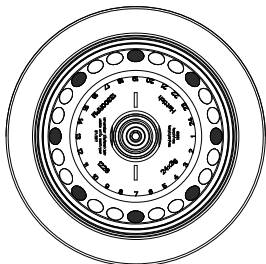

Il rotore è caricato uniformemente

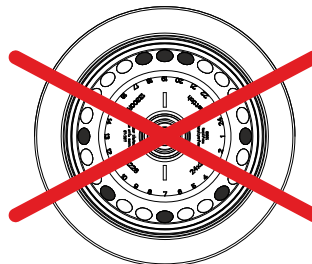

Non ammesso!

Il rotore è caricato in modo non uniforme

- L'operazione di riempimento dei contenitori di centrifugazione è ammessa solo al di fuori della centrifuga.
- Il carico massimo dei recipienti della centrifuga non deve essere superiore a quello indicato dalla casa costruttrice.

Il riempimento dei contenitori di centrifugazione è consentito solo fino al livello per cui, durante l'operazione di centrifugazione, non venga espulso alcun liquido dai contenitori.

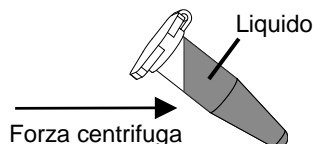

- Con il caricamento del rotore non deve pervenire alcun liquido nel rotore e nel vano di centrifugazione.
- Per limitare al massimo le differenze di peso all'interno dei contenitori di centrifugazione, bisogna fare attenzione che siano riempiti tutti in modo uguale.
- Su ogni rotore è indicato il peso della quantità di riempimento consentita. Tale peso non deve mai essere superato.

14 Chiudere i sistemi biologici di sicurezza



Per garantire la tenuta, il coperchio di un sistema biologico di sicurezza deve essere ben chiuso.

Per evitare che durante l'apertura e la chiusura del coperchio l'anello di guarnizione si giri, spalmarvi, frizionando leggermente, polvere di talco o una sostanza per la cura della gomma.

Per quanto riguarda i sistemi biologici di sicurezza fornibili, rimandiamo al capitolo "Anhang/Appendix, Rotoren und Zubehör/Rotors and accessories". Nel dubbio chiedere maggiori informazioni al produttore o importatore.

Coperchio con chiusura a vite e manopola

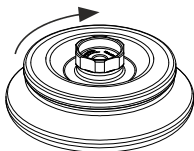

- Applicare il coperchio centralmente sul rotore.
- Chiudere con forza a mano il coperchio, girando la manopola in senso orario.

15 Elementi di comando e di visualizzazione

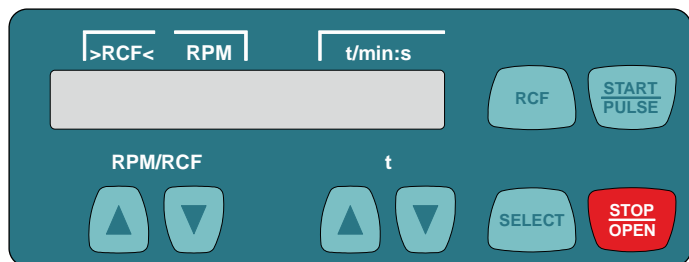

15.1 Simboli esposti



Coperchio sbloccato.



Coperchio bloccato.



Indicazione di rotazione. L'indicazione di rotazione si illumina e ruota senso antiorario, per il tempo in cui il rotore è in rotazione.

15.2 Tasti del campo di comando

RPM/RCF



- Immettere direttamente il regime di rotazione.
- Tenendo premuto il tasto il valore cambia con l'incrementare della velocità.

t



- Immettere direttamente il tempo di funzionamento. Regolabile fino ad 1 minuto in passi di 1 secondo ed a partire da 1 minuto in passi di 1 minuto.
- Immettere il parametro di centrifugazione.
- Tenendo premuto il tasto il valore cambia con l'incrementare della velocità.



- Tasto per la selezione dei singoli parametri. Ad ogni ulteriore pressione del tasto viene selezionato il parametro successivo.
- Richiamare "MACHINE MENU" (tener premuto il tasto per 8 secondi).
- Scegliere nel "Machine Menu" i menu "→ Info", "→ Settings" e "→ Time & Cycles".
- Sfogliare in avanti nei menu.



- Commutazione tra l'indicazione RPM (RPM) e l'indicazione RCF (>RCF<). I valori RCF vengono indicati tra parentesi ><.
- RPM: Regime di rotazione
- RCF : Accelerazione relativa di centrifuga



- Avviare il processo di centrifugazione.
- Centrifugazione breve. Il processo di centrifugazione avviene, per il tempo in cui il tasto viene premuto.
- Richiamare i menu "→ Info", "→ Settings" e "→ Time & Cycles".



- Terminare il processo di centrifugazione. Il rotore rallenta con il livello di frenata preselezionato. Una doppia pressione del tasto sgancia l'Arresto di Emergenza.
- Sbloccare il coperchio.

15.3 Possibilità di regolazione

t/min **Tempo di funzionamento.** Regolabile da 1 - 99 min, in passi di 1 minuto.

t/sec **Tempo di funzionamento.** Regolabile da 1 - 59 s, in passi di 1 secondo.

Funzionamento continuo "---:--". Impostare il parametro **t/min** e **t/sec** su zero.

RPM **Regime di rotazione**

Può essere impostato un valore numerico di 200 RPM fino al regime massimo di rotazione del rotore. Impostabile da 200 RPM fino a 10000 RPM in passi da 10 ed oltre i 10000 RPM in passi da 100. Per il regime massimo di rotazione del rotore vedere al capitolo "Appendice/Appendix, Rotori ed accessori/Rotors and accessories".

>RCF< **Accelerazione relativa di centrifuga**

Può essere impostato un valore numerico, con il quale si ottiene un regime di rotazione tra 200 RPM ed il massimale regime di rotazione del rotore.

Impostabile fino a 10000 in passi di 1 ed oltre i 10000 in passi di 10.



L'inoltro della accelerazione relativa di centrifuga (RCF) è possibile solo, se viene scelta l'indicazione RCF (>RCF<).

L'accelerazione relativa di centrifuga (RCF) dipende dal raggio di centrifugazione (RAD). Dopo l'inoltro di RCF verificare, che sia impostato l'esatto raggio di centrifugazione.

RAD/mm **Raggio di centrifugazione**

Impostabile da 10 mm fino a 250 mm, in passi di 1 millimetro.

Per il raggio di centrifugazione vedere al capitolo "Appendice/Appendix, Rotori ed accessori/Rotors and accessories".







L'inoltro del raggio di centrifugazione è possibile solo, se viene scelta l'indicazione RCF (>RCF<).

~\DEC **Livello di frenata.** **fast** = arresto in breve tempo, **slow** = arresto in tempo lungo.

16 Immettere il parametro di centrifugazione

16.1 Inoltro diretto del parametro di centrifugazione

Il regime di rotazione (RPM), la accelerazione relativa di centrifuga (RCF), il raggio di centrifugazione (RAD) ed il tempo di funzionamento possono venire immessi direttamente con i tasti  , senza dover premere in precedenza il tasto .

 I parametri di centrifugazione impostati vengono memorizzati solo dopo l'avvio del processo di centrifugazione.

16.1.1 Regime di rotazione (RPM)

Esempio:

 • In caso di necessità premere il tasto per selezionare l'indicazione RPM (RPM).

>RCF<	RPM	t/min:s
☰	4500	5:00



 • Scegliere con i tasti il valore desiderato.

>RCF<	RPM	t/min:s
☰	4000	5:00

16.1.2 Accelerazione relativa di centrifuga (RCF) e raggio di centrifugazione (RAD)

Esempio:

 • In caso di necessità premere il tasto per selezionare l'indicazione RCF (>RCF<).

>RCF<	RPM	t/min:s
☰	> 1947<	5:00



 • Scegliere con i tasti il valore RCF desiderato.

>RCF<	RPM	t/min:s
☰	> 1538<	RAD= 86



 ^t • In caso di necessità impostare con i tasti il raggio di centrifugazione desiderato.

>RCF<	RPM	t/min:s
☰	> 1538<	RAD= 67

>RCF<	RPM	t/min:s
☰	> 1538<	5:00

16.1.3 Tempo di funzionamento

 Il tempo di funzionamento può venire impostato fino ad 1 minuto in passi di 1 secondo ed a partire da 1 minuto solo in passi di un minuto.

Per impostare il funzionamento continuo, i parametri **t/min** e **t/sec** devono venir impostati su zero. Sull'indicatore del tempo (t/min:s) compare "---:--".

Esempio:

>RCF<	RPM	t/min:s
☰	4500	--:--

Esempio:

 ^t • Scegliere con i tasti il valore desiderato.

>RCF<	RPM	t/min:s
☰	4500	5:00

16.2 Inoltro del parametro di centrifugazione con il tasto "SELECT"



Il tempo di funzionamento può venire impostato in minuti ed in secondi (parametri **t/min** e **t/sec**).

Per impostare il funzionamento continuo, i parametri **t/min** e **t/sec** devono venir impostati su zero. Nell'indicatore del tempo (t/min:s) compare "--:--".

Esempio:





L'accelerazione relativa di centrifuga (RCF) dipende dal raggio di centrifugazione (RAD).

Durante l'inoltro dell'RCF viene esposto il raggio di centrifugazione impostato.

Se dopo la selezione o durante l'inoltro dei parametri, per otto secondi di tempo non viene premuto alcun tasto, sul display vengono esposti di nuovo di valori precedenti. L'inoltro dei parametri deve poi venire eseguito nuovamente.

Premendo il tasto  vengono memorizzate le impostazioni.

Con l'inoltro di più parametri, il tasto  deve venir premuto solo dopo l'impostazione dell'ultimo parametro.

L'inoltro dei parametri può sempre venire interrotto premendo il tasto . In questo caso le impostazioni non vengono memorizzate.

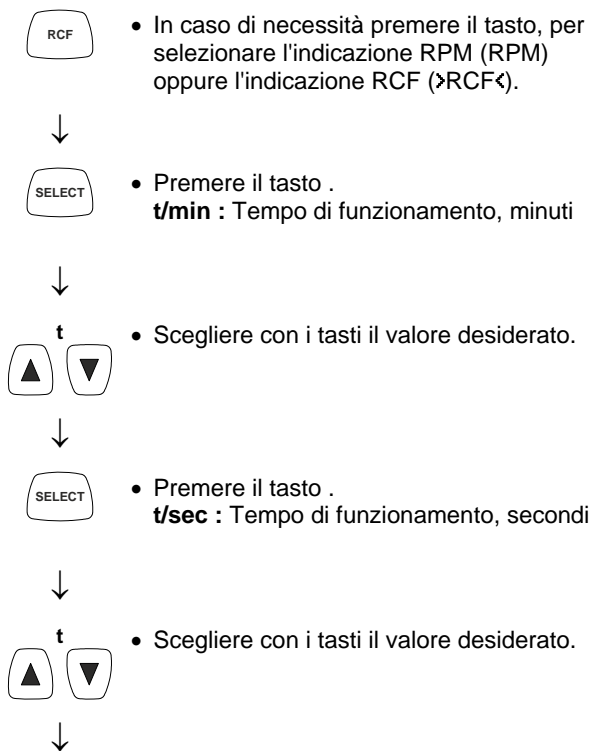

Prosegua alla pagina successiva

Esempio: Indicazione RPM (RPM)

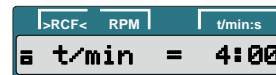
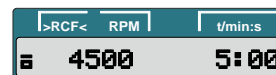

Esempio: Indicazione RCF (>RCF<)

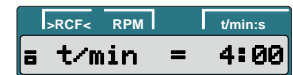
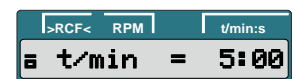



- Premere il tasto.
RPM : Regime di rotazione.
RAD/mm : Raggio di centrifugazione.
 La visualizzazione e l'inoltro del raggio di centrifugazione è possibile solo, se viene scelta l'indicazione RCF (>RCF<).

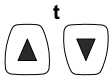

- Scegliere con i tasti il valore desiderato.



- Premere il tasto.
R : Raggio di centrifugazione.
RCF : Accelerazione relativa di centrifuga.



- Scegliere con i tasti il valore desiderato.



- Premere il tasto .
_DEC : Livello di frenata.
fast : arresto in breve tempo.
slow : arresto in tempo lungo.



- Scegliere con i tasti il valore desiderato.



- Premere il tasto per memorizzare l'impostazione.

Esempio: Indicazione RPM (RPM)

>RCF<	RPM	t/min:s
RPM	=	4500

>RCF<	RPM	t/min:s
RPM	=	4000

>RCF<	RPM	t/min:s
_DEC	=	slow

>RCF<	RPM	t/min:s
_DEC	=	fast

>RCF<	RPM	t/min:s
4000		4:30

Esempio: Indicazione RCF (>RCF<)

>RCF<	RPM	t/min:s
RAD/mm	=	86

>RCF<	RPM	t/min:s
RAD/mm	=	67

>RCF<	RPM	t/min:s
R: 67	RCF=	1947

>RCF<	RPM	t/min:s
R: 67	RCF=	1198

>RCF<	RPM	t/min:s
_DEC	=	slow

>RCF<	RPM	t/min:s
_DEC	=	fast

>RCF<	RPM	t/min:s
> 1538 <		4:30

17 Centrifugazione



Durante un processo di centrifugazione, come da norme EN / IEC 61010-2-020 non deve trovarsi alcuna persona, prodotti pericolosi ed oggetti in un settore di sicurezza di 300 mm attorno alla centrifuga.



Dopo ogni processo di centrifugazione, durante lo sbloccaggio del coperchio, viene esposta per breve tempo la quantità dei cicli operativi rimanenti (processi di centrifugazione).

Esempio:



Se con il caricamento del rotore è stata superata la differenza di peso ammessa, il processo di centrifugazione viene interrotto durante l'avvio e compare la seguente videata:



Un processo di centrifugazione può sempre venire interrotto premendo il tasto .

Durante un processo di centrifugazione i parametri di centrifugazione possono venire selezionati e modificati. I valori modificati sono validi però solo per l'attuale processo di centrifugazione e non vengono memorizzati.

Con il tasto  può avvenire in qualsiasi momento la commutazione tra l'indicazione RPM (RPM) e l'indicazione RCF (>RCF<). Se il lavoro avviene con l'indicazione RCF (>RCF<) è necessario l'inoltro del raggio di centrifugazione.

Viene esposto quanto segue



un ulteriore intervento operativo alla centrifuga è possibile solo dopo l'apertura del coperchio.

Gli errori operativi e le anomalie vengono esposti (vedere il capitolo "Anomalie").

- Inserire l'interruttore di rete. Posizione dell'interruttore I.
- Caricare il rotore e chiudere il coperchio della centrifuga.

17.1 Centrifugazione con preselezione del tempo



- In caso di necessità premere il tasto, per selezionare l'indicazione RPM (RPM) oppure l'indicazione RCF (>RCF<).



- Immettere il parametro di centrifugazione desiderato (vedere al capitolo "Immettere il parametro di centrifugazione").



- Premere il tasto, per avviare il processo di centrifugazione.

Durante il processo di centrifugazione vengono esposti il regime di rotazione del rotore od il valore RCF che ne risulta e il tempo residuo.



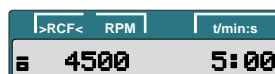

Prosegue alla pagina successiva

Esempio:
Indicazione RPM (RPM)

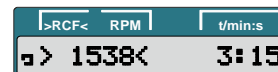
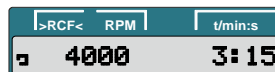
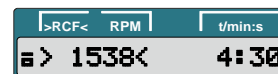
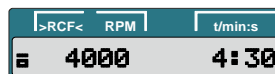
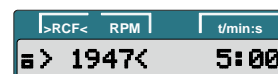

Esempio:
Indicazione RCF (>RCF<)



- Una volta decorso il tempo o dopo l'interruzione del processo di centrifugazione premendo il tasto , avviene l'arresto con il livello di frenate impostato. Viene esposto il livello di frenata. Esempio 

Esempio:
Indicazione RPM (RPM)



Esempio:
Indicazione RCF (>RCF<)

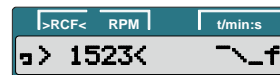

17.2 Funzionamento continuo



- In caso di necessità premere il tasto, per selezionare l'indicazione RPM (RPM) oppure l'indicazione RCF (>RCF<).



- Immettere il parametro di centrifugazione desiderato. Impostare i parametri **t/min** e **t/sec** su zero (vedere al capitolo "Immettere il parametro di centrifugazione").



- Premere il tasto, per avviare il processo di centrifugazione .
Durante il processo di centrifugazione vengono esposti il regime di rotazione del rotore od il valore RCF che ne risulta e il tempo decorso.



- Premere il tasto, per terminare il processo di centrifugazione .
L'arresto avviene con il livello di frenata impostato. Viene esposto il livello di frenata. Esempio 

Esempio:
Indicazione RPM (RPM)

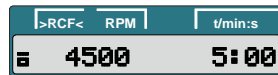

Esempio:
Indicazione RCF (>RCF<)

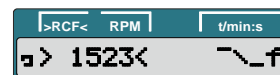
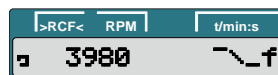
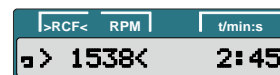
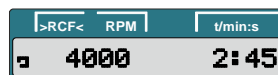
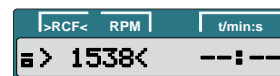
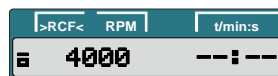
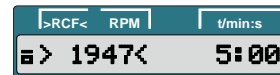

17.3 Centrifugazione breve



- In caso di necessità premere il tasto, per selezionare l'indicazione RPM (RPM) oppure l'indicazione RCF (>RCF<).



- Immettere il parametro di centrifugazione desiderato (vedere al capitolo "Immettere il parametro di centrifugazione").



- Premere il tasto e tenerlo premuto. Durante il processo di centrifugazione vengono esposti il regime di rotazione del rotore od il valore RCF che ne risulta e il tempo decorso.



- Abbandonare il tasto per terminare il processo di centrifugazione. L'arresto avviene con il livello di frenata impostato. Viene esposto il livello di frenata. Esempio \sim_f .

Esempio: Indicazione RPM (RPM)

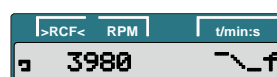
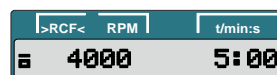
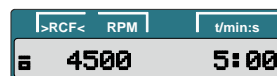

Esempio: Indicazione RCF (>RCF<)

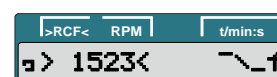
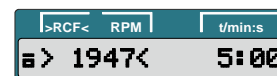

18 Arresto di Emergenza



- Premere due volte il tasto. Con l'arresto di emergenza, l'arresto avviene con il livello di frenata "fast" (arresto in breve tempo). Viene esposto il livello di frenata \sim_f .

Esempio: Indicazione RPM (RPM)

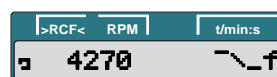

Esempio: Indicazione RCF (>RCF<)



19 Contatore cicli

 La durata di impiego del rotore è limitata a 50000 cicli operativi (processi di centrifugazione).

La centrifuga è dotata di un contatore cicli, che conteggia i cicli operativi (processi di centrifugazione).

Dopo ogni processo di centrifugazione, durante lo sbloccaggio del coperchio, viene esposta per breve tempo la quantità dei cicli operativi rimanenti (processi di centrifugazione).

Esempio:

```
>RCF< RPM | t/min:s
RemCycles= 16703
```

Se la quantità massima ammessa dei cicli operativi del rotore è oltrepassata, dopo ogni avvio di un processo di centrifugazione compare la seguente videata ed il processo di centrifugazione deve essere avviato di nuovo.

```
>RCF< RPM | t/min:s
Cycles Passed
```

 Viene esposto quanto segue

```
>RCF< RPM | t/min:s
Cycles Passed
```

per ragioni di sicurezza il rotore deve venire sostituito immediatamente con un rotore nuovo.

Dopo che il rotore è stato sostituito, il contatore cicli deve venire rassettato su "0" (vedere al capitolo "Resettare contatore cicli su "0").

20 Impostazioni e consultazioni

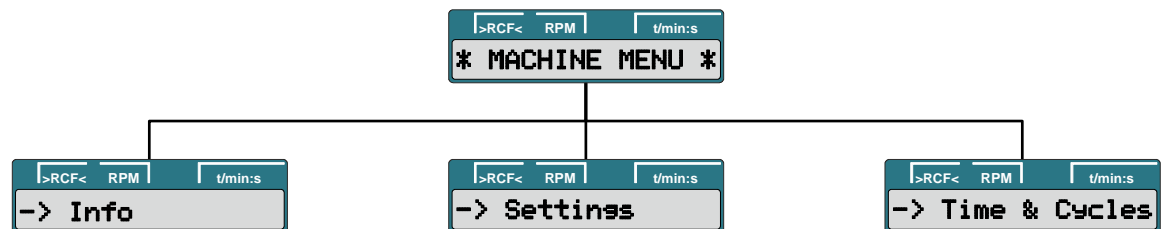

Consultazione:

- Informazioni di sistema

Impostazione:

- Segnale acustico
- Sbloccaggio automatico del coperchio dopo il processo di centrifugazione
- Disinserimento automatico dell'illuminazione di sfondo
- Segnale ottico dopo la fine del processo di centrifugazione

Consultazione:

- Ore di esercizio
- Quantità di processi di centrifugazione eseguiti

Impostazione:

- Contatore cicli

20.1 Consultare informazioni di sistema

Possono venir consultate le seguenti informazioni di sistema:

- Modello dell'apparecchiatura e suo massimo regime di rotazione,
- Versione del programma dell'apparecchiatura,
- Numero del tipo di apparecchiatura,
- Data di produzione dell'apparecchiatura,
- Numero di serie dell'apparecchiatura,
- Tipo di convertitore di frequenza,
- Versione di programma del convertitore di frequenza

La consultazione può essere eseguita, durante l'arresto del rotore, come segue:

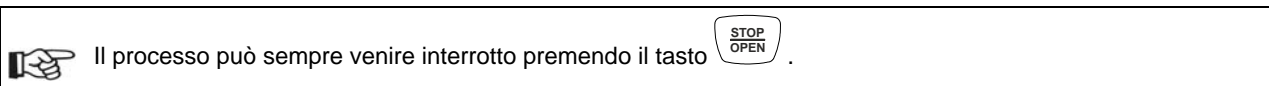

- Tenere premuto il tasto 8 secondi.



- Premere il tasto.



- Premere il tasto.
Modello dell'apparecchiatura e suo massimo regime di rotazione.

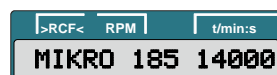

- Premere il tasto.
Versione del programma dell'apparecchiatura.

Esempio:

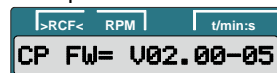

- Premere il tasto.
Type#1 : Numero del tipo di apparecchiatura

Esempio:



- Premere il tasto.
Type#2 : Proseguenza del numero del tipo, se questi ha più posizioni del campo di videata "**Type#1**".

Esempio:

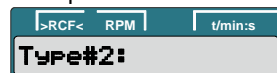

- Premere il tasto.
Data di produzione dell'apparecchiatura.

Esempio:



Prosegue alla pagina successiva



- Premere il tasto..
Numero di serie dell'apparecchiatura.

Esempio:

>RCF<	RPM	t/min:s
Serial#: 0016234		



- Premere il tasto .
Tipo di convertitore di frequenza.

Esempio:

>RCF<	RPM	t/min:s
FC type LC 300VA		



- Premere il tasto .
Versione di programma del convertitore di frequenza.

Esempio:

>RCF<	RPM	t/min:s
FC FW= D 1.04		



- Premere due volte il tasto, per abbandonare il menu "→ Info" o premere tre volte, per abbandonare il menu "* MACHINE MENU *" .

Esempio:

>RCF<	RPM	t/min:s
* MACHINE MENU *		

>RCF<	RPM	t/min:s
6	4500	5:00



20.2 Segnale acustico

Suona il segnale acustico:

- dopo che si è presentata un'anomalia, in intervalli di 2 s.
- dopo che è terminato il processo di centrifugazione e con l'arresto del rotore, in intervalli di 30 s.

Il segnale acustico viene disinserito premendo un tasto piacere.

Il segnale acustico può essere impostato, durante l'arresto del rotore, come segue:

 Il processo può sempre venire interrotto premendo il tasto . In questo caso le impostazioni non vengono memorizzate.

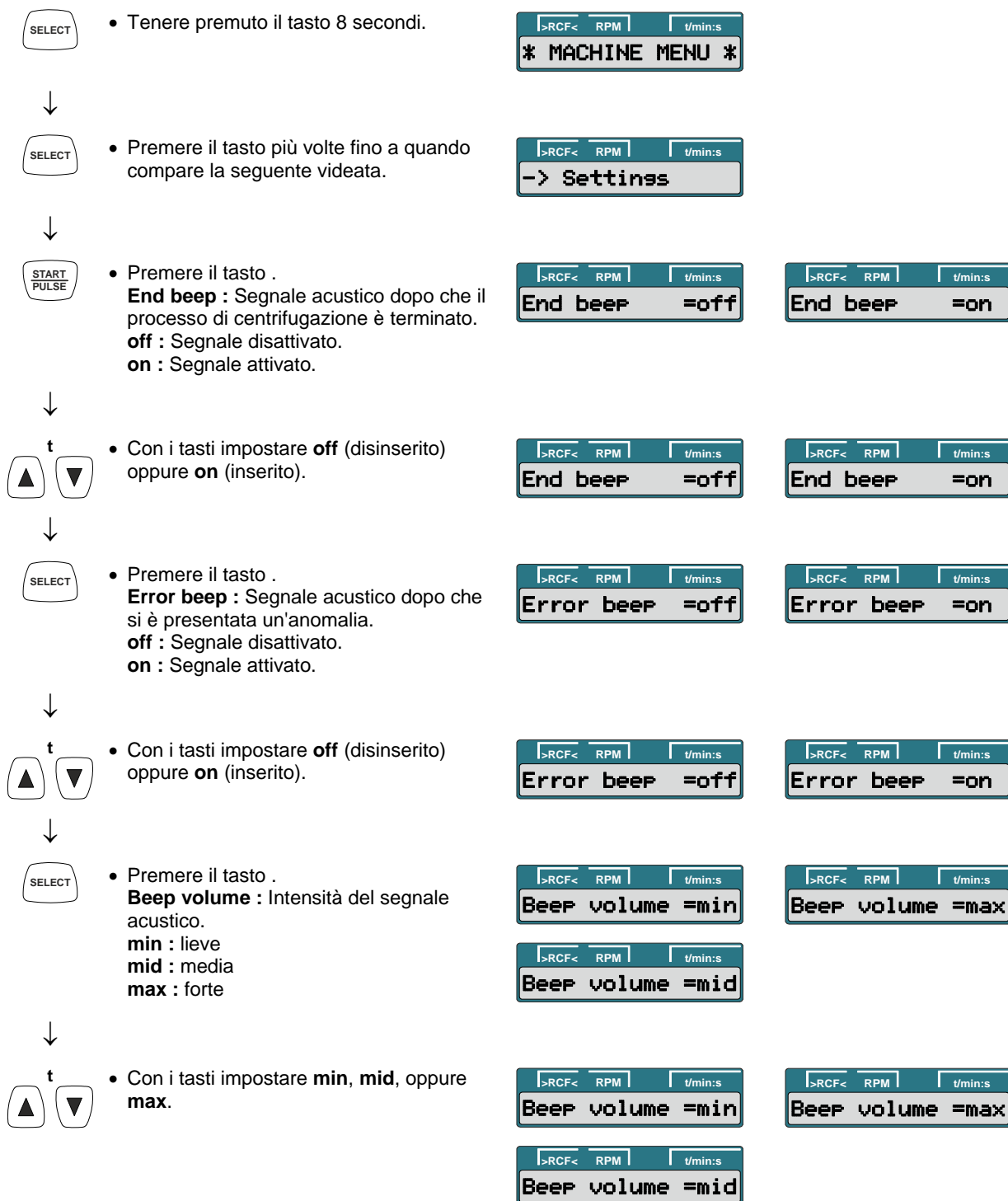

Prosegue alla pagina successiva



- Premere il tasto per memorizzare l'impostazione.

```
>RCF< RPM t/min:s
Store settings...
```

```
>RCF< RPM t/min:s
-> Settings
```



- Premere una volta il tasto, per abbandonare il menu "-> Settings" oppure prendere due volte, per abbandonare il menu "* MACHINE MENU *".

```
>RCF< RPM t/min:s
* MACHINE MENU *
```



Esempio:

```
>RCF< RPM t/min:s
4 4500 5:00
```

20.3 Segnale ottico dopo la fine del processo di centrifugazione

La illuminazione di sfondo della videata lampeggia dopo il processo di centrifugazione, per segnalare otticamente che il processo di centrifugazione è terminato.

Il segnale ottico può essere inserito o disinserito, durante l'arresto del rotore, come segue:

 Il processo può sempre venire interrotto premendo il tasto .



- Tenere premuto il tasto 8 secondi.

```
>RCF< RPM t/min:s
* MACHINE MENU *
```



- Premere il tasto più volte fino a quando compare la successiva videata.

```
>RCF< RPM t/min:s
-> Settings
```



- Premere il tasto .

```
>RCF< RPM t/min:s
End beep =off
```

```
>RCF< RPM t/min:s
End beep =on
```



- Premere più volte il tasto fino a quando compare una delle due videate.
End blinking : Lampeggio della illuminazione di sfondo della videata dopo il processo di centrifugazione.
off : La illuminazione di sfondo non lampeggia.
on : La illuminazione di sfondo lampeggia.

```
>RCF< RPM t/min:s
End blinking=off
```

```
>RCF< RPM t/min:s
End blinking=on
```



- Con i tasti impostare **off** (disinserito) oppure **on** (inserito).

```
>RCF< RPM t/min:s
End blinking=off
```

```
>RCF< RPM t/min:s
End blinking=on
```



- Premere il tasto per memorizzare l'impostazione.

```
>RCF< RPM t/min:s
Store settings...
```

```
>RCF< RPM t/min:s
-> Settings
```



- Premere una volta il tasto, per abbandonare il menu "-> Settings" oppure prendere due volte, per abbandonare il menu "* MACHINE MENU *".

```
>RCF< RPM t/min:s
* MACHINE MENU *
```

Esempio:

```
>RCF< RPM t/min:s
4 4500 5:00
```

20.4 Sbloccaggio automatico del coperchio dopo il processo di centrifugazione

Può avvenire l'impostazione, se dopo il processo di centrifugazione il coperchio si sblocca o meno.

Ciò può venire impostato, durante l'arresto del rotore, come segue:



Il processo può sempre venire interrotto premendo il tasto . In questo caso le impostazioni non vengono memorizzate.



- Tenere premuto il tasto 8 secondi.



- Premere il tasto più volte fino a quando compare la successiva videata.



- Premere il tasto .



- Premere più volte il tasto fino a quando compare una delle due videate.
Lid AutoOpen : Sbloccaggio automatico del coperchio dopo il processo di centrifugazione.
off : Il coperchio non si sblocca automaticamente.
on : Il coperchio si sblocca automaticamente.



- Con i tasti impostare **off** oppure **on**.



- Premere il tasto per memorizzare l'impostazione.



- Premere una volta il tasto, per abbandonare il menu "-> Settings" oppure prendere due volte, per abbandonare il menu "* MACHINE MENU *".



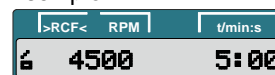

Esempio:





















20.5 Illuminazione di sfondo della videata

Per risparmiare energia può venire impostato, che dopo un processo di centrifugazione l'illuminazione di sfondo della videata si spenga dopo due minuti.

Ciò può venire impostato, durante l'arresto del rotore, come segue:

 Il processo può sempre venire interrotto premendo il tasto . In questo caso le impostazioni non vengono memorizzate.

	<ul style="list-style-type: none"> • Tenere premuto il tasto 8 secondi. 		
↓			
	<ul style="list-style-type: none"> • Premere il tasto più volte fino a quando compare la seguente videata: 		
↓			
	<ul style="list-style-type: none"> • Premere il tasto . 		
↓			
	<ul style="list-style-type: none"> • Premere più volte il tasto fino a quando compare una delle due videate. Power save : Disinserimento automatico dell'illuminazione di sfondo. off : Disinserimento automatico disattivato. on : Disinserimento automatico attivato. 		
↓			
	<ul style="list-style-type: none"> • Con i tasti impostare off (disinserito) oppure on (inserito). 		
↓			
	<ul style="list-style-type: none"> • Premere il tasto per memorizzare l'impostazione. 		
↓			
	<ul style="list-style-type: none"> • Premere una volta il tasto, per abbandonare il menu "-> Settings" oppure prendere due volte, per abbandonare il menu "* MACHINE MENU *". 		<p>Esempio:</p> 



20.6 Consultazione delle ore di funzionamento e della quantità di processi di centrifugazione

Le ore di funzionamento sono suddivise in ore di funzionamento interne ed esterne.

Ore di funzionamento interne: Tempo complessivo, nel quale l'apparecchiatura era inserita.

Ore di funzionamento esterne: Tempo complessivo dei processi di centrifugazione avvenuti fino ad ora.

La consultazione può essere eseguita, durante l'arresto del rotore, come segue:

 Il processo può sempre venire interrotto premendo il tasto .



- Tenere premuto il tasto 8 secondi.

>RCF<	RPM	t/min:s
* MACHINE MENU *		



- Premere il tasto più volte fino a quando compare la successiva videata.

>RCF<	RPM	t/min:s
-> Time & Cycles		



- Premere il tasto .
TimeExt : Ore di funzionamento esterne.

Esempio:

>RCF<	RPM	t/min:s
TimeExt=		43 h



- Premere il tasto .
TimeInt : Ore di funzionamento interne.

Esempio:

>RCF<	RPM	t/min:s
TimeInt=		60 h



- Premere il tasto .
Starts : Quantità di tutti i processi di centrifugazione.

Esempio:

>RCF<	RPM	t/min:s
Starts=		325



- Premere due volte il tasto, per abbandonare il menu "-> Time & Cycles" o premere tre volte, per abbandonare il menu "* MACHINE MENU *".

Esempio:



>RCF<	RPM	t/min:s
* MACHINE MENU *		4500 5:00

20.7 Resettare su zero il contatore cicli

Dopo che il rotore è stato sostituito, il contatore cicli deve venir resettato su zero.

 Il resettaggio su zero del contatore cicli è ammesso solo, se il rotore è stato sostituito in precedenza con un rotore nuovo.

Il resettaggio del contatore cicli può essere eseguito, durante l'arresto del rotore, come segue:

 Il processo può sempre venire interrotto premendo il tasto . In questo caso le impostazioni non vengono memorizzate.

SELECT

- Tenere premuto il tasto 8 secondi.

>RCF< RPM t/min:s
* MACHINE MENU *



SELECT

- Premere il tasto più volte fino a quando compare la seguente videata:

>RCF< RPM t/min:s
-> Time & Cycles



START PULSE

- Premere il tasto .

Esempio:

>RCF< RPM t/min:s
TimeExt= 43 h



SELECT

- Premere il tasto più volte fino a quando compare la seguente videata:
Cyc sum : Quantità di cicli operativi eseguiti.

>RCF< RPM t/min:s
Cyc sum= 50001



RCF

- Premere il tasto .

>RCF< RPM t/min:s
Cyc sum=< 50001>



t



- Premere il tasto .
La quantità di cicli operativi eseguiti viene resettata su zero.

>RCF< RPM t/min:s
Cyc sum=< 0>



START PULSE

- Premere il tasto per memorizzare l'impostazione.

>RCF< RPM t/min:s
Store cycles ...

>RCF< RPM t/min:s
Cyc sum= 0



STOP OPEN

- Premere due volte il tasto, per abbandonare il menu "-> Time & Cycles" o premere tre volte, per abbandonare il menu "* MACHINE MENU *".

>RCF< RPM t/min:s
* MACHINE MENU *

Esempio:

>RCF< RPM t/min:s
6 4500 5:00

21 Accelerazione centrifuga relativa (RCF)

L'accelerazione centrifuga relativa (RCF) è indicata come un multiplo dell'accelerazione terrestre (g). È un valore numerico privo di unità e funge per paragonare le prestazioni di separazione de sedimentazione.

Il calcolo viene eseguito in base alla formula:

$$RCF = \left(\frac{RPM}{1000} \right)^2 \times r \times 1,118 \quad \Rightarrow \quad RPM = \sqrt{\frac{RCF}{r \times 1,118}} \times 1000$$

RCF = accelerazione centrifuga relativa

RPM = numero dei giri

r = raggio di centrifugazione in mm = distanza dal centro dell'asse di rotazione fino al fondo del recipiente di centrifugazione. Raggio di centrifugazione vedi al capitolo "Anhang/Appendix, Rotoren und Zubehör/Rotors and accessories".



L'accelerazione centrifuga relativa (RCF) dipende dal numero dei giri e dal raggio di centrifugazione.

22 Centrifugazione di sostanze o di miscele di sostanze con densità maggiore di 1,2 kg/dm³

In caso di centrifugazione con massimo numero di giri, la densità dei materiali o delle miscele di materiali non deve superare il valore di composizione di 1,2 kg/dm³.

Con sostanze o miscele di sostanze di densità maggiore, il regime di rotazione deve venire ridotto.

Il numero di giri consentito si calcola con la formula seguente:

$$\text{numero di giri ridotto (n}_{red}\text{)} = \sqrt{\frac{1,2}{\text{densità maggiore [kg/dm}^3\text{]}}} \times \text{regime massimo di rotazione [RPM]}$$

p.es.: regime massimo di rotazione RPM 4000, densità 1,6 kg/dm³

$$n_{red} = \sqrt{\frac{1,2 \text{ kg/dm}^3}{1,6 \text{ kg/dm}^3}} \times 4000 \text{ RPM} = 3464 \text{ RPM}$$

In caso di dubbio, rivolgersi al costruttore per maggiori informazioni.

23 Sbloccaggio di emergenza

Nel caso di uscita di servizio della corrente il coperchio non può venire sbloccato motoricamente. Deve essere eseguito uno sbloccaggio di emergenza di tipo manuale.



Per lo sbloccaggio di emergenza staccare la centrifuga dalla rete di alimentazione.
Aprire il coperchio solo a rotore fermo.



ATTENZIONE! Danneggiamento della chiusura, durante lo sbloccaggio di emergenza, quando la chiave a forchetta esagonale viene girata in senso orario (verso destra).
La rotazione della chiave a forchetta esagonale è ammessa solo in senso antiorario (verso sinistra), vedere illustrazione.

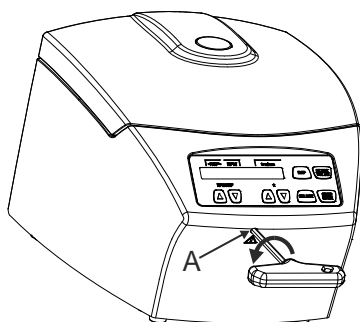

- Disinserire l'interruttore di rete (posizione di interruttore "0").
- Guardare dalla finestra che si trova sul coperchio per assicurarsi che il rotore sia fermo.
- Introdurre orizzontalmente nel foro (A) la chiave a forchetta esagonale e girare con cautela in senso antiorario (verso sinistra), fino a quando il coperchio si apre.
- Estrarre poi la chiave a forchetta esagonale dal foro.

24 Pulizia e manutenzione



L'apparecchiatura può essere contaminata.



Prima della pulizia, staccare la presa di corrente.

Prima di iniziare un procedimento di pulizia e decontaminazione diverso da quello consigliato dal produttore, l'utilizzatore deve accertarsi presso il produttore che tale procedimento previsto non rechi danno all'apparecchio.

- Centrifughe, rotori e accessori non devono essere lavati in lavastoviglie.
- Si deve eseguire solo una pulizia manuale ed una disinfezione con liquido.
- La temperatura dell'acqua deve essere di 20 – 25°C.
- Devono essere utilizzati solo detersivi o disinfettanti che:
 - abbiano un campo di valori del pH che va da 5 a 8,
 - non contengano alcali caustici, perossidi, composti di cloro, acidi e soluzioni alcaline.
- Seguire attentamente le indicazioni speciali del produttore sull'impiego di detersivi e disinfettanti, al fine di evitare qualsiasi fenomeno di corrosione.

24.1 Centrifughe (scatola, coperchio e vano di centrifugazione)

24.1.1 Cura e pulizia delle superfici

- Pulire regolarmente il corpo della centrifuga e la camera di centrifugazione e impiegare all'occorrenza sapone o un detersivo delicato e un panno umido. Ciò serve da un lato per l'igiene e dall'altro lato per evitare la corrosione causata da impurità incrostate.
- Ingredienti dei detersivi adatti: sapone, tensidi anionici, tensidi non ionici.
- Dopo l'impiego di detersivi, rimuovere i resti del detersivo pulendo di nuovo con un panno umido.
- Le superfici devono essere asciugate subito dopo la pulizia.
- In caso di formazione di acqua di condensa, asciugare la camera di centrifugazione pulendola con un panno assorbente.
- Controllare una volta l'anno se il vano di centrifugazione presenta danneggiamenti.



Se vengono stabiliti danni rilevanti per la sicurezza, la centrifuga non deve essere più messa in funzione. In questo caso si deve contattare il servizio assistenza clienti.

24.1.2 Disinfezione delle superfici

- In presenza di materiale infettivo nella camera di centrifugazione si deve disinfettarla immediatamente.
- Ingredienti dei disinfettanti adatti: etanolo, alcol n proclitico, etilexanolo, tensidi anionici, inibitori di corrosione.
- Dopo l'impiego di disinfettanti, rimuovere i resti del disinfettante pulendo di nuovo con un panno umido.
- Le superfici devono essere asciugate subito dopo la disinfezione.

24.1.3 Rimuovere contaminazioni radioattive

- La sostanza deve essere certificata in modo speciale per rimuovere contaminazioni radioattive.
- Ingredienti di sostanze adatte alla rimozione di contaminazioni radioattive: tensidi anionici, tensidi non ionici, etanolo poliidrato.
- Dopo aver rimosso le contaminazioni radioattive, rimuovere i resti della sostanza pulendo di nuovo con un panno umido.
- Le superfici devono essere asciugate, subito dopo la rimozione delle contaminazioni radioattive.

24.2 Rotori ed accessori

24.2.1 Pulizia e cura

- Per prevenire corrosione e alterazioni dei materiali, i rotori e l'accessorio devono essere regolarmente puliti con sapone o con un detergente delicato e con un panno umido. Si consiglia la pulizia almeno una volta la settimana. La sporcizia deve essere subito rimossa.
- Ingredienti dei detergenti adatti:
sapone, tensidi anionici, tensidi non ionici.
- Dopo l'impiego di detergenti, rimuovere i resti del detergente, risciacquando con acqua (solo al di fuori della centrifuga) o ripulendo con un panno umido.
- I rotori e gli accessori devono essere asciugati immediatamente dopo la pulizia.
- Nei sistemi di sicurezza biologici (Per quanto riguarda i sistemi biologici di sicurezza fornibili, rimandiamo al capitolo "Anhang/Appendix, Rotoren und Zubehör/Rotors and accessories") gli anelli di guarnizione devono essere controllati e puliti periodicamente (ogni settimana). In presenza di crepe, parti fragili o logorio, l'anello di tenuta deve essere subito sostituito. Per evitare che durante l'apertura e la chiusura del coperchio l'anello di guarnizione si giri, spalmarvi, frizionando leggermente, polvere di talco o una sostanza per la cura della gomma.
- Per evitare la corrosione causata dall'umidità tra il rotore e l'albero motore, si deve provvedere almeno una volta al mese di smontare il rotore, pulirlo e di lubrificare leggermente l'albero motore.
- I rotori e l'accessorio devono essere controllati una volta al mese per verificare che non vi siano usura o danni da corrosione.



Rotori ed accessori non devono essere più utilizzati se presentano consumo o corrosione.

- Verificare settimanalmente la posizione del rotore.

24.2.2 Disinfezione

- Se del materiale infetto viene a contatto con i rotori o con gli accessori, allora si deve eseguire una disinfezione adeguata.
- Ingredienti dei disinfettanti adatti:
etanolo, alcol n proclitico, etilexanolo, tensidi anionici, inibitori di corrosione.
- Dopo l'impiego di disinfettanti, rimuovere i resti del disinfettante, risciacquando con acqua (solo al di fuori della centrifuga) o ripulendo con un panno umido.
- I rotor e gli accessori devono essere asciugati immediatamente dopo la disinfezione.

24.2.3 Rimuovere contaminazioni radioattive

- La sostanza deve essere certificata in special modo per rimuovere contaminazioni radioattive.
- Ingredienti di sostanze adatte alla rimozione di contaminazioni radioattive:
tensidi anionici, tensidi non ionici, etanolo poliidrato.
- Dopo la rimozione delle contaminazioni radioattive, rimuovere la sostanza, risciacquando con acqua (solo al di fuori della centrifuga) o ripulendo con un panno umido.
- I rotor e gli accessori devono essere asciugati subito dopo la rimozione delle contaminazioni radioattive.

24.2.4 Rotori ed accessori con limitata durata di impiego

La durata di impiego dei rotor è limitata ad una particolare quantità di cicli operativi (operazioni di centrifugazione). La quantità massima ammessa dei cicli operativi è visibile sul rotore.



Per motivi di sicurezza l'impiego del rotore non è più ammesso, quando è stato raggiunto il numero di cicli consentiti riportato in contrassegno su di esso.

L'apparecchiatura è dotata di un contatore di cicli, che conteggia i cicli operativi (operazioni di centrifugazione). Per la descrizione vedere al capitolo "Contatore cicli".

24.3 Trattamento in autoclave



I rotori possono essere trattati in autoclave a 121°C / 250°F (20 min).

Dopo 10 trattamenti in autoclave, per motivi di sicurezza il rotore deve venire sostituito.

Dopo il trattamento in autoclave attendere prima del suo impiego, fino a quando il rotore ha raggiunto la temperatura ambiente.

Per quanto riguarda il grado di sterilizzazione non può essere citato alcun dato.



Il coperchio del rotore ed il contenitore devono essere staccati prima di essere riposti in autoclave.

Il trattamento in autoclave accelera il processo di invecchiamento delle plastiche. Possono inoltre verificarsi modifiche del colore delle plastiche.

24.4 Contenitori centrifuga

- In caso di mancanza di tenuta o dopo la rottura dei contenitori per centrifugazione, rimuovere completamente i frammenti dei contenitori, le schegge di vetro e il centrifugato fuoriuscito.
- Dopo la rottura di parti in vetro, sostituire gli inserti di gomma e i manicotti di plastica dei rotori.



Le schegge di vetro rimaste causano ulteriori rotture!



- Nel caso di materiale infettivo, bisogna provvedere immediatamente ad una disinfezione.

25 Guasti

Se non si riesce a eliminare l'errore seguendo le indicazioni della tabella guasti, informare il servizio assistenza clienti.

Si prega di indicare il tipo di centrifuga e il numero di serie. Entrambi i numeri sono visibili sulla targhetta di modello della centrifuga.

	<p>Esecuzione di un RESET RETE:</p> <ul style="list-style-type: none"> - Disinserire l'interruttore di rete (posizione interruttore "0"). - Attendere almeno 10 secondi quindi reinserire l'interruttore di rete (posizione interruttore "1").
---	--

Visualizzazione/guasto		Causa	Eliminazione
Nessun indicatore		Assenza di tensione Scatto del fusibile di sicurezza per sovracorrente.	<ul style="list-style-type: none"> - Controllare la tensione di alimentazione. - Controllare i fusibili di ingresso di rete, vedere il capitolo "Sostituzione fusibili entrata rete". - Interruttore generale ACCESO.
IMBALANCE		Il rotore è caricato in modo non uniforme.	<ul style="list-style-type: none"> - Aprire il coperchio dopo che il rotore si è fermato. - Controllare il caricamento del rotore, vedere il capitolo "Carico del rotore". - Ripetere il ciclo di centrifugazione.
MAINS INTER	11	Interruzione di rete durante il ciclo di centrifugazione. (Il ciclo di centrifugazione non viene terminato.)	<ul style="list-style-type: none"> - Aprire il coperchio dopo che il rotore si è fermato. - Premere tasto . - All'occorrenza ripetere il ciclo di centrifugazione.
MAINS INTERRUPT			
TACHO ERROR	1, 2	Mancanza degli impulsi del numero di giri durante il funzionamento.	<ul style="list-style-type: none"> - Dopo l'arresto del rotore eseguire un RESET RETE.
LID ERROR	4.1 – 4.127	Errore blocco coperchio, ovvero chiusura coperchio.	
OVER SPEED	5	N° giri eccedente	
VERSION ERROR	12	Riconosciuto un modello di centrifuga sbagliato. Guasto/difetto sistema elettronico.	<ul style="list-style-type: none"> - Dopo l'arresto del rotore eseguire un RESET RETE.
UNDER SPEED	13	N° giri insufficiente	
CTRL ERROR	22.1, 25.2	Guasto/difetto sistema elettronico.	
CRC ERROR	27.1		
COM ERROR	31 – 36		
FC ERROR	60, 61.1 – 61.21, 61.64 – 61.142		
FC ERROR	61.23	Errore misurazione regime di rotazione	<ul style="list-style-type: none"> - Il disinserimento dell'apparecchiatura non è ammesso, fino a quando l'indicazione della rotazione  è luminosa e ruota. Attendere fino a quando il simbolo  (coperchio bloccato) viene esposto (dopo ca. 120 secondi). Eseguire poi un RESET RETE.
TACHO ERR	61.22		
FC ERROR	61.153	Guasto/difetto sistema elettronico.	<ul style="list-style-type: none"> - Esecuzione di un RESET RETE. - Controllare il caricamento del rotore, vedere il capitolo "Carico del rotore". - Ripetere il ciclo di centrifugazione.

26 Sostituzione fusibili entrata rete



Spegnere l'interruttore di rete e staccare l'apparecchio dall'alimentazione!

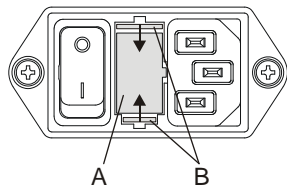

Il portafusibili (A) con i fusibili d'entrata rete si trova accanto all'interruttore di rete.

- Estrarre il cavo di collegamento dalla spina.
- Premere la chiusura a scatto (B) contro il portafusibili (A) ed estrarre quest'ultimo.
- Sostituire i fusibili di rete difettosi.



Utilizzate solo fusibili con valori nominali fissati per il rispettivo tipo, vedere la successiva tabella.

- Inserire di nuovo il portafusibili fino a far scattare la chiusura.
- Allacciare di nuovo l'apparecchio alla rete.

Modello	Tipo	Fusibile	N° ord.
MIKRO 185	1203	T 3,15 AH/250V	E997
MIKRO 185	1203-01	T 6,3 AH/250V	2266

27 Rispedizione di apparecchi



Prima di rispedire un apparecchio deve essere montata la protezione per il trasporto.

Se l'apparecchio o uno dei suoi accessori viene rispedito alla ditta Andreas Hettich GmbH & Co. KG, esso deve essere prima decontaminato e pulito per la tutela di persone, ambiente e materiale.

Ci riserviamo la facoltà di accettare apparecchi o accessori contaminati.

Eventuali costi di pulizia e disinfezione verranno fatturati al cliente.

Contiamo a questo riguardo sulla vostra comprensione.

28 Smaltimento

Prima dello smaltimento, l'apparecchiatura deve essere decontaminata e pulita con lo scopo di proteggere le persone, l'ambiente e il materiale.

Per lo smaltimento dell'apparecchio osservare le rispettive norme di legge.

Ai sensi della direttiva 2002/96/CE (RAEE) tutti gli apparecchi forniti dopo il 13/08/2005 non possono più essere smaltiti con i rifiuti domestici. Questo apparecchio appartiene alla categoria 8 (Dispositivi medicali) ed è classificato nel settore Business-to-Business.











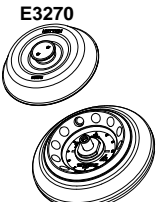



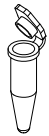







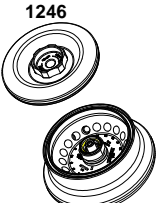

Il simbolo della pattumiera cancellata con una croce indica che l'apparecchio non deve essere smaltito con i rifiuti domestici.

Le norme per lo smaltimento possono essere differenti nei singoli paesi UE. In caso di necessità rivolgersi al proprio rivenditore.

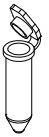
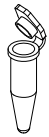
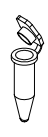
29 Anhang / Appendix



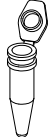







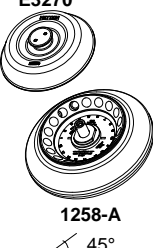



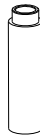

29.1 Rotoren und Zubehör / Rotors and accessories

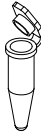



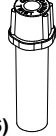





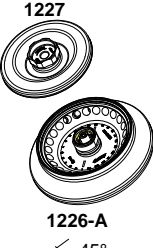



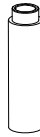

4) 1252-A + E3270 Winkelrotor 12-fach / Angle rotor 12-times	2) 2031		2023		2024					
 <p>E3270</p> <p>1252-A</p> <p>∠ 45°</p> <p>max. Laufzyklen /max. cycles: 50000</p>										
	0536	2078							0788	
								+		
Kapazität / capacity	ml	2,0	1,5	0,5	0,8	0,4	0,2	0,5		
Maße / dimensions	∅ x L	mm		11 x 38	8 x 30	8 x 45	6 x 45	6 x 18	10,7 x 36	
Anzahl p. Rotor / number p. rotor		12	12	12	12	12	12	12		
Drehzahl / speed	RPM	14000								
RZB / RCF		15558						14462		
Radius / radius	mm	71	71	71	71	71	71	66		
 (97%)	sec	15								
 1	sec	15								
Probenerwärmung/sample temp. rise	K ¹⁾	15								

4) 1213-A + 1246 Winkelrotor 18-fach / Angle rotor 18-times	2) 2031		2023		2024		2) 2031			
 <p>1246</p> <p>1213-A</p> <p>∠ 45°</p> <p>max. Laufzyklen /max. cycles: 50000</p>										
	0536	2078						Micro Spin Column		
										
Kapazität / capacity	ml	2,0	1,5	0,5	0,8	0,4	0,2	2,0	1,5	
Maße / dimensions	∅ x L	mm		11 x 38	8 x 30	8 x 45	6 x 45	6 x 18	11 x 38	
Anzahl p. Rotor / number p. rotor		18	18	18	18	18	18	18		
Drehzahl / speed	RPM	14000								
RZB / RCF		16654								
Radius / radius	mm	76	76	76	76	76	76	76		
 (97%)	sec	16								
 1	sec	15								
Probenerwärmung/sample temp. rise	K ¹⁾	19								

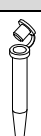
- 1) Probenerwärmung bei maximaler Drehzahl und 1 Stunde Laufzeit
- 2) bei hochtouriger Zentrifugation empfohlen
- 3) autoklavierbar
- 4) autoklavierbar, phenolbeständig
- 5) mit Bioabdichtung (nach DIN EN 61010, Teil 2 – 020). Die Hinweise für Bio-Sicherheitssysteme in den Kapiteln "Sicherheitshinweise" und "Pflege und Wartung" beachten.

- 1) Sample temp. rise during maximum speed and 1 hour running time
- 2) recommended for high-speed centrifugation
- 3) autoclavable
- 4) autoclavable, phenol resistant
- 5) with bio-containment (in conformity with DIN EN 61010, part 2 – 020). Observe the notes for bio safety systems in chapters "Notes on safety" and "Maintenance and servicing".

4) 1258-A + E3270		2) 2031	2023			2024				
Winkelrotor 18-fach / Angle rotor 18-times  E3270   1258-A  45° max. Laufzyklen / max. cycles: 50000										
		0536 	2078 						0788 	
Kapazität / capacity	ml	2,0	1,5	0,5	0,8	0,4	0,2	0,5		
Maße / dimensions	∅ x L	mm	11 x 38	8 x 30	8 x 45	6 x 45	6 x 18	10,7 x 36		
Anzahl p. Rotor / number p. rotor			18	18	18	18	18	9		
Drehzahl / speed	RPM	14000								
RZB / RCF		16654							15558	
Radius / radius	mm	76	76	76	76	76	76	71		
 (97%)	sec								15	
 1	sec								15	
Probenerwärmung/sample temp. rise	K ¹⁾								17	

4) 1226-A + 1227		2) 2031	2023			2024				
Winkelrotor 24-fach / Angle rotor 24-times  1227   1226-A  45° max. Laufzyklen / max. cycles: 50000										
		0536 	2078 						0788 	
Kapazität / capacity	ml	2,0	1,5	0,5	0,8	0,4	0,2	0,5		
Maße / dimensions	∅ x L	mm	11 x 38	8 x 30	8 x 45	6 x 45	6 x 18	10,7 x 36		
Anzahl p. Rotor / number p. rotor			24	24	24	24	24	12		
Drehzahl / speed	RPM	14000								
RZB / RCF		18845							17749	
Radius / radius	mm	86	86	86	86	86	86	81		
 (97%)	sec								15	
 1	sec								15	
Probenerwärmung/sample temp. rise	K ¹⁾								22	

- 1) Probenerwärmung bei maximaler Drehzahl und 1 Stunde Laufzeit
- 2) bei hochtouriger Zentrifugation empfohlen
- 3) autoklavierbar
- 4) autoklavierbar, phenolbeständig
- 5) mit Bioabdichtung (nach DIN EN 61010, Teil 2 – 020). Die Hinweise für Bio-Sicherheitssysteme in den Kapiteln "Sicherheitshinweise" und "Pflege und Wartung" beachten.
- 6) Nur jeden zweiten Platz des Rotors beladen

- 1) Sample temp. rise during maximum speed and 1 hour running time
- 2) recommended for high-speed centrifugation
- 3) autoclavable
- 4) autoclavable, phenol resistant
- 5) with bio-containment (in conformity with DIN EN 61010, part 2 – 020). Observe the notes for bio safety systems in chapters "Notes on safety" and "Maintenance and servicing".
- 6) Load only each second position of the rotor