

Operation Manual (EN)
Translation of the german original manual

Diaphragm pumps 2 - headed

Models:

- ▶ MPC / MP 101 Z
- ▶ MPC / MP 201 E



Gardner Denver Thomas GmbH

Am Vogelherd 20

98693 Ilmenau

Germany

T +49 3677 604 0

F +49 3677 604 131

welch.emea@gardnerdenver.com

www.welchvacuum.com

Customer Support +49 3677 604 0

We are constantly working on the further development of all our product models.

Reprinting or reproduction of this manual, including extracts, is not allowed without the prior written permission of Co. Gardner Denver Thomas GmbH.

All rights under the copyright laws are expressly reserved by Co. Gardner Denver Thomas GmbH.

We reserve the right to make changes and amendments.

Contents

1	Important Information	4
1.1	General Information	4
1.2	Target Groups	4
1.3	Intended Use.....	4
1.4	Use for an Unauthorized Purpose	4
1.5	Safety Devices	5
1.6	Meaning of the Warning notes	5
1.7	Product Standards, Safety Regulations.....	5
2	Basic Safety Instructions	6
2.1	General Information	6
2.2	Electricity.....	6
2.3	Mechanical Systems.....	6
2.4	Hazardous Substances.....	7
2.5	High Temperatures	7
3	Description	8
3.1	Design	8
3.2	Principle of Operation	8
3.3	Gas ballast	8
3.4	Areas of Application	9
3.5	Pump head circuitry	9
3.6	Materials of the medium-affecting pump parts.....	9
3.7	Scope of Delivery	9
3.8	Accessories.....	10
4	Technical Data	11
4.1	Dimensions	11
4.2	Intake Pressure / Pumping Speed – Diagram	11
4.3	Device Data.....	12
5	Installation and Operation	13
5.1	Unpacking	13
5.2	Installation and Connection.....	13
5.3	Operation	13
5.4	Storage.....	13
5.5	Scrap Disposal	13
6	Maintenance and Servicing	14
6.1	General Requirements.....	14
6.2	Maintenance Performed by the User	14
6.2.1	Disassembly.....	15
6.2.2	Assembly.....	15
6.2.3	Test	16
6.3	Maintenance by the Manufacturer	16
6.4	Damage Report	16
7	Troubleshooting	17
8	Spare Parts Overview	18
8.1	Service kit.....	18
8.2	Spare parts view	19
8.2.1	Spare parts list diaphragm pumps MP 101 Z	20
8.2.2	Spare parts list diaphragm pumps MP 201 E	21
8.2.3	Spare parts list diaphragm pumps MPC 101 Z.....	22
8.2.4	Spare parts list diaphragm pumps MPC 201 E.....	23

- **Instructions for certification - Diaphragm Pumps MPC -**
for use in Zone 2 in accordance with device category 3 per ATEX Directive 2014/34/EU
(Page 1 - 3)

- **EC Declaration of Conformity**

Important Information

1 Important Information

1.1 General Information

The Diaphragm Pumps conform to the following directives:

2006 / 42 / EC	Machinery Directive
2014 / 30 / EU	Electromagnetic Compatibility Directive
2014 / 34 / EU	ATEX Guideline for use in potentially explosive atmospheres, Appendix III (<i>at models MPC only</i>)

The CE sign is located on the rating plate. Observe the binding national and local regulations when fitting the pump into installations.

Our products are sold worldwide and can therefore be equipped with the typical national plugs and for the various voltages. You will find more information about the available pump designs on our web page in the internet.

1.2 Target Groups

This Operating Manual is intended for the personnel planning, operating and maintaining Diaphragm Pumps.

This group of people includes:

- Designers and fitters of vacuum apparatus,
- Employees working on commercial laboratory and industrial vacuum technology applications and
- Service personnel for diaphragm pumps

The personnel operating and maintaining the diaphragm pumps must have the technical competence required to perform the work that has to be done. The user must authorize the operating personnel to do the work that has to be done. The personnel must have read and understood the complete Operating Manual before using the diaphragm pumps.

The Operating Manual must be kept at the place of use and be available to the personnel when required.

1.3 Intended Use

- The layout of the diaphragm pump must be appropriate for the conditions of use. The user bears the sole responsibility for this.
- The diaphragm pump may only be operated under the conditions stated
 - in the "Technical Data" section,
 - on the type plate, and
 - in the technical specification for the order concerned.
- Diaphragm pumps are approved for extracting, pumping and compressing gases and vapours. If these gases and vapours are toxic or explosive, then the user must observe the currently valid safety regulations for this application. Special types of diaphragm pumps are available for aggressive and explosive gas mixtures.

1.4 Use for an Unauthorized Purpose

It is forbidden to use the pump for applications deviating from the technical data stated on the type plate or the conditions stated in the supply contract, or to operate it with missing or defective protective devices.

1.5 Safety Devices

Measures such as the following are for the safety of the operating personnel:

- electrical connection with a protective conductor (operating mode S1) and an earthing plug,
- Motor protection switch (thermal) and
- "Hot Surface" label on the pump body - warning notice 

The diaphragm pump must not be operated without these elements.

1.6 Meaning of the Warning notes

Take note of the warning notices. They are in the following box:

	CAUTION ! / WARNING !
Hazard which may lead to serious injuries or material damage.	

1.7 Product Standards, Safety Regulations

Diaphragm Pumps meet the following product standards:

DIN EN ISO 12100:2011-03	Safety of machinery - General principles for design - Risk assessment and risk reduction
DIN EN ISO 13857:2008-06	Safety of machinery - Safety distances to prevent hazard zones being reached by upper and lower limbs
DIN EN 1012-2:2011-12	Compressors and vacuum pumps - Safety requirements - Part 2: Vacuum pumps
DIN EN ISO 2151:2009-01	Acoustics - Noise test code for compressors and vacuum pumps - Engineering method (grade 2)
DIN EN 60204-1:2014-10	Safety of machinery - Electrical equipment of machines - Part 1: General requirements
DIN EN 61000-6-2:2011-06 DIN EN 61000-6-4:2011-09	Electromagnetic compatibility (EMC) - Part 6-2: Generic standards - Immunity for industrial environments Part 6-4: Generic standards - Emission standard for industrial environments
DIN EN 61010-1/A1:2015-04	Safety requirements for electrical equipment for measurement, control and laboratory use - Part 1: General requirements
DIN EN 50110-1:2014-02	Operation of electrical installations
DIN EN 1127-1:2011-10	Explosive atmospheres - Explosion prevention and protection - Part 1: Basic concepts and methodology
DIN EN 13463-1:2009-07 DIN EN 13463-5:2011-10	Non-electrical equipment for use in potentially explosive atmospheres - Part 1: Basic method and requirements Part 5: Protection by constructional safety 'c'
Directive 2012/19/EU	Electrical and electronics - old devices (WEEE)
Directive 2011/65/EU	Dangerous materials in electrical and electronics devices (RoHS II)
China - RoHS II	Environment protection law - China 2016-01

The following additional safety regulations apply in the FR Germany:

DGUV Regulation 1	Accident prevention regulations, principles of prevention
DGUV Regulation 3	Safety and testing of electrical equipment and equipment
DGUV Rule 100-500	Operation of work equipment
DGUV Information 213-850	Safe working in laboratories

Observe the standards and regulations applying in your country when you use the diaphragm pumps.

Basic Safety Instructions

2 Basic Safety Instructions

2.1 General Information

Warning notices must be observed. Disregarding them may lead to damage to health and property.

The diaphragm pumps must be operated by personnel who can detect impending dangers and take action to prevent them from materialising.

The manufacturer or authorized workshops will only service or maintain the diaphragm pump if it is accompanied by a fully completed damage report. Precise information about the contamination (also negative information if necessary) and thorough cleaning of the diaphragm pump are legally binding parts of the contract.

Contaminated diaphragm pumps and their individual parts must be disposed of in accordance with the legal regulations.

The local regulations apply in foreign countries.

2.2 Electricity

The diaphragm pumps of operation mode S1 are supplied. When the location of operation mode S1 devices is changed, please note that the testing must be repeated in accordance with DIN EN 0105, DIN EN 0702 and DGUV Regulation 3.

The local regulations apply in foreign countries.

Please note the following when connecting to the electrical power supply system:

- The electrical power supply system must have a protective connector according to DIN IEC 60364-4-41.
- The protective connector must not have any breaks.
- The connecting cable must not be damaged.

2.3 Mechanical Systems

Improper use can lead to injuries or material damage. Observe the following instructions:

- Only operate the diaphragm pumps with hoses of the specified dimensions.
- The maximum permissible pressure of 1 bar at the suction connection must not be exceeded.
- Hazardous substances must be separated out as far as this is technically possible before they reach the pump.
- External mechanical stresses and vibrations must not be transmitted to the pump. Only use flexible NW 8 laboratory hoses for connecting diaphragm pumps.
- The overpressure generated at the pressure port must not exceed 1 bar.
- The pump must not be used to suck up fluids. Lay the exhaust pipe so that it slopes downwards, so allowing condensate to flow out of the pump. Collect the condensate and dispose of it in an environmentally compatible manner.
- Prevent dyes exuding.
- Maintain a space of least 20 mm between the pump and adjacent parts in order to enable the pump to cool.

	CAUTION !
Solid particles in the pumping medium impair the pumping action and can lead to damage. Prevent solid particles penetrating into the pump.	

2.4 Hazardous Substances

The operating company bears the responsibility for the use of the diaphragm pump. Hazardous substances in the gases to be pumped can cause personal injuries and property damage. Pay attention to the warning notices for handling hazardous substances. The local regulations apply in foreign countries.

Combustible Gases

Examine before switching on whether that can form gas combustible gas/air mixtures which can be promoted! Consider the regulations of the guideline 1999/92/EC.

Explosive gases

The diaphragm pumps of the series **MPC** are certified according to ATEX guidelines 2014/34/EU, device category 3, valid for the gas contacting parts (interior) of the pump. The diaphragm pumps of the series **MP** are not certified according to ATEX guidelines 2014/34/EU.

Aggressive gases

The **MPC** series is designed for extracting contaminated gases!

The use of diaphragm pumps of the series **MP** cannot be recommended for such cases of application!

Especially aggressive gases have to be explicitly checked for material resistance as described *in chapter 3.6* and, if necessary, modified.

Poisonous gases

Use a separator when pumping poisonous or harmful gases. Prevent such substances from leaking out of the appliance or pump. Treat these substances according to the applicable environmental protection regulations.

Test the strength and leak-tightness of the connecting lines and the connected apparatus. Prevent environmental poisons, e.g. mercury, getting into the diaphragm pumps.

Fulfil the requirements, for example:

- German Hazardous Substances Regulation (GefStoffV) of 01. December 2010
- Regulations 2016/1179/EU (classification, packaging and identification of hazardous substances),
- Manufacturer's safety data sheets on hazardous substances.

2.5 High Temperatures

The diaphragm pump may heat up as a result of the temperature of the gas being pumped and through compression heat.

Prevent the following maximum permissible temperatures from being exceeded + 40 °C for the environment and the gas to be pumped.

The motor for single phase alternating current is protected against overload by an integrated motor protection switch.

Description

3 Description

3.1 Design

The diaphragm pump consists of a pump casing and a drive motor. The pump casing contains the drive unit and two four pump heads. Both pump head contains a diaphragm and the work valves. Two pairs of pump heads are arranged opposite each other. The pump heads are driven via an eccentric shaft with a connecting rod.

1 to 2 stage pumps are supplied, depending upon the circuitry of the pump heads.

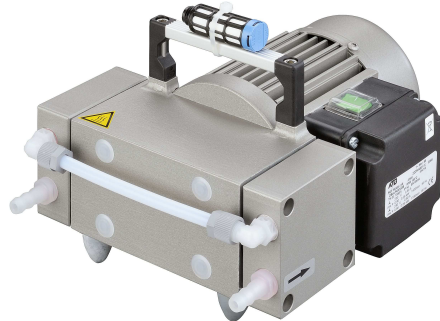

Fig. 1 Diaphragm pump MP 101 Z

3.2 Principle of Operation

Motor, eccentric shaft and connecting rod set the diaphragms in stroke movement. This changes the size of the space between the diaphragms and pump head (pump chamber). Increasing the size of the pump chamber opens the inlet valve while the outlet valve is closed (intake process).

Decreasing the size of the pump chamber ejects the gas through the outlet valve.

The valves are actuated by the gas being pumped. A large proportion of fluid in the diaphragm pump minimizes the pumping efficiency.

3.3 Gas ballast

When condensable vapours are pumped, they may be compressed above the saturated vapour pressure and condense.

Opening the gas ballast valve (1) in the suction line of the last pump stage allows air to flow into the pump chamber. This prevents condensation and flushes the pump clear. Operation leads to increasing the ultimate pressure and the operating temperature.

The gas ballast valve is only provided as standard for MPC type diaphragm pumps. The fitting into other pump types is an option or must be specified in the supply contract.

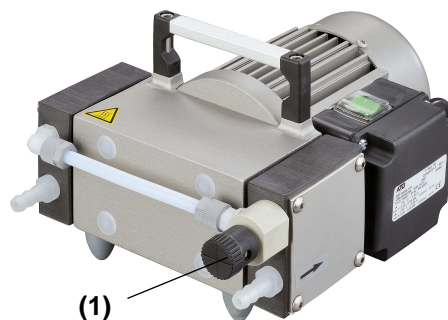

Fig. 2 MPC 101 Z with gas ballast valve

3.4 Areas of Application

The Diaphragm Pumps are intended for:

- Pumping and compressing neutral and aggressive gases and vapours.
- Generating a vacuum down to an ultimate pressure < 8 mbar.
- Use in physical and chemical laboratories in trade and industry.
- Use for vacuum filtration, vacuum distillation and vacuum drying, and other vacuum technology applications.

3.5 Pump head circuitry

One-stage (E):	Both pump heads are connected in parallel.
Ultimate pressure:	< 75 mbar
Models:	MP 201 E and MPC 201 E

Two-stage (Z):	Both pump heads are connected in series.
Ultimate pressure:	< 8 mbar
Models:	MP 101 Z and MPC 101 Z

Special designs:

- Special diaphragm pumps can be supplied after consultation with the manufacturer or for a corresponding supply contract.
- Motors for different voltages.

3.6 Materials of the medium-affecting pump parts

Component	Standard design MP model	Chemical model MPC model <i>(resistant to aggressive gases)</i>
Seal	EPDM	EPDM
Screw fitting / Connecting elements	PVDF, PP	PVDF, PP
Valve	PEEK	PEEK
Diaphragm	Elastomer + PTFE Layer	Elastomer + PTFE Layer
Vacuum hose	PTFE	PTFE
Connection head / Pump head	Aluminium	PTFE with carbon-fibre reinforcing *)



*) electrically conductive (with manufacturer's certificate of electrical conductivity)
Material resistance to aggressive media see: Publisher Hoppenstedt Publishing (18. September 2007)

3.7 Scope of Delivery

The scope of delivery is specified in the supply contract.

Description

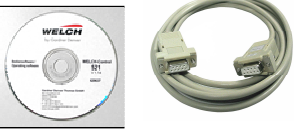
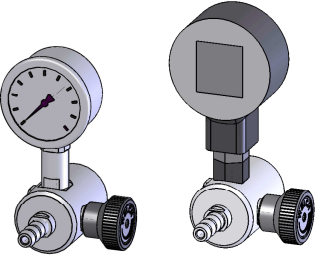
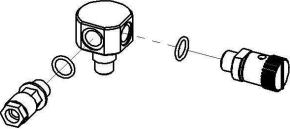
3.8 Accessories

Figure	Designation / Usage	Order no.
	Vacuum Control-Box Type: VCB 521 cv for measuring and regulation of vacuum	600053
	Operating software "WELCH-Control 521" on CD with Dual-Data Cable to connect to the PC	620637-01
	Vacuum Regulator with Dial Gauge DBR-B - analog - digital allows the adjustment of the ultimate pressure (suction side)	700458-10 700458-11
	Gas ballast valve, manually operated Additional connection set for diaphragm pumps type MP...	400599-02
	Vacuum hose rubber, 18 / 8x5 mm 1.5 m - red	828310-4
	Mains connection cable with plug Type 12 (CH) for diaphragm pumps ... in 230 V	825877

4 Technical Data

4.1 Dimensions

The main dimensions are identical for all pump types stated here.

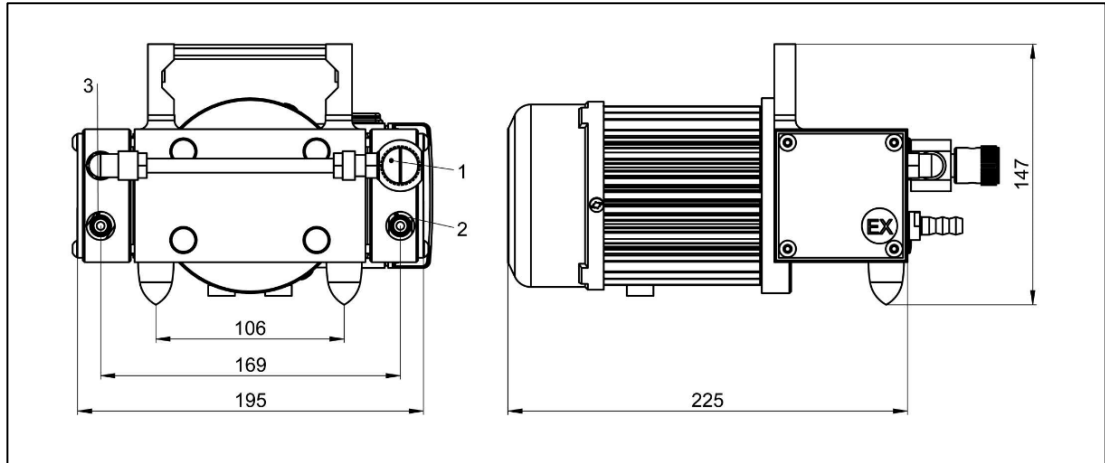

1	Gas ballast valve	(for MPC only)
2	Intake port	(for hose DN 8)
3	Pressure port	(for hose DN 8)

Fig. 3 Dimensions (MPC 101 Z)

4.2 Intake Pressure / Pumping Speed – Diagram

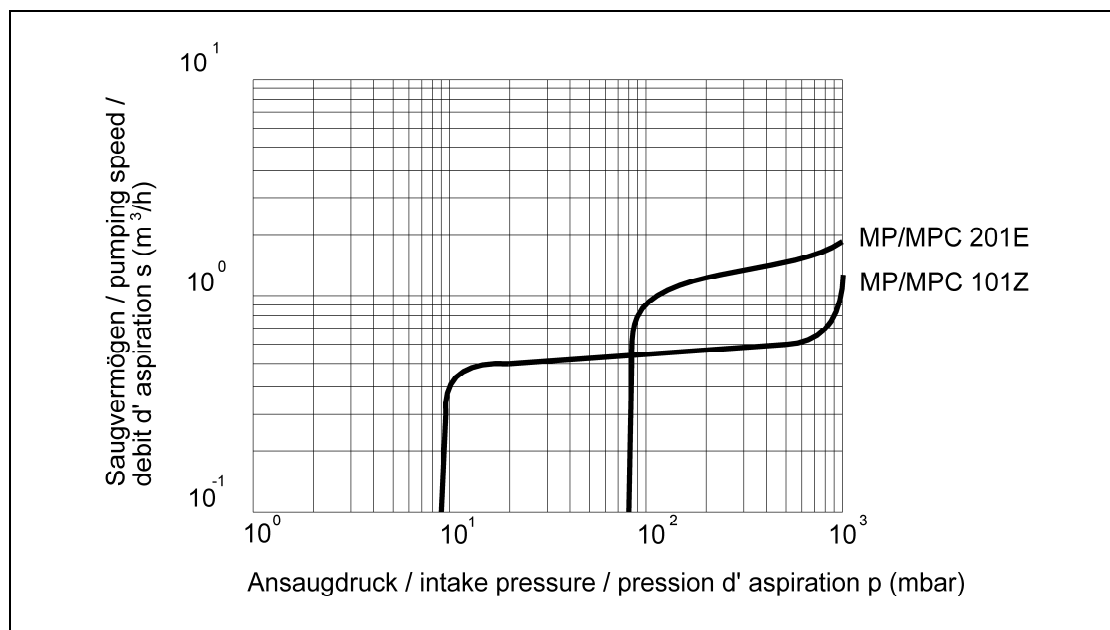



Fig. 4 Intake Pressure / Pumping Speed - Diagram

Technical Data

4.3 Device Data

Parameter	Unit	Diaphragm pump types			
		MP 201 E	MPC 201 E	MP 101 Z	MPC 101 Z
		one-stage		two-stage	
Pumping performance DIN 28432 at speed of 1500 rpm	m ³ / h	1.8 / 2.0		1.0 / 1.1	
	l / min	30.0		16.7	
Ultimate pressure at speed of 1500 rpm		< 75		< 8	
Ultimate pressure with gas ballast (with MPC only) at speed of 1500 rpm	mbar	-	90	-	18
Max. inlet pressure	bar	1			
Max. outlet pressure		1			
Intake and pressure ports	-	Hose nozzle DN 8 for hose inside diameter 8 mm			
Ambient temperature	°C	+ 10 to + 40			
Max. Operating gas temperature		+ 40			
Bearing	-	maintenance-free			
Reference surface sound pressure level DIN EN ISO 2151	dB (A)	< 44			
Voltage / Frequency (different data upon customer request)	V, Hz	230, 50/60 / 115, 50/60 / 100, 50/60 (generally with motor protection switch, switch and cable)			
Power	kW	0.06			
Operating mode		S 1			
Type of protection DIN EN 60529	-	IP 54			
Class of insulation DIN EN 600034-1		F (160°C)			
Type Examination Certificate no. (at MPC only)	-	WELCH_ATEX_03-01			
Designation EX (at MPC only)		 II3G IIC T3 X (internal Atm. only)			
Weight	kg	6.5			
Dimensions (W/D/H)	mm	195 / 235 / 145			
Order numbers for:					
- Diaphragm pump - 230 V inclusive mains connection cables IEC with plug CEE, UK		411521	412521	411522	412522
- Diaphragm pump - 230 V inclusive mains connection cables IEC with plug China GB1002	-	-	-	-	412522-40
- Diaphragm pump - 115 V inclusive mains connection cable IEC with plug US		411521-01	412521-01	411522-01	412522-01
- Diaphragm pump - 100 V inclusive mains connection cable IEC with plug J		-	412521-04	-	412522-04

The information presented in this material is based on technical data and test results of nominal units. It is believed to be accurate and reliable and is offered as an aid to help in the selection of products. It is the responsibility of the user to determine the suitability of the product for the intended use and the user assumes all risk and liability whatsoever in connection therewith. Gardner Denver Thomas GmbH does not warrant, guarantee or assume any obligation or liability in connection with this information.

5 Installation and Operation

5.1 Unpacking

Carefully unpack the diaphragm pump.

Check the pump for:

- Transport damage,
- Conformity with the specifications of the supply contract (type, electrical supply data),
- Completeness of the delivery.

Please inform us without delay if there are discrepancies between the delivery and the contractually agreed scope of delivery, or if damage is detected.

Please take note of the general terms of business of the manufacturing firm.

In case of a claim under warranty, the device must be returned in packaging that is suitable for protecting it during transport.

5.2 Installation and Connection

1. Set the diaphragm pump on a flat and horizontal surface.
2. Remove the protective caps on the suction and pressure ports.
3. Prepare the connections.
4. Connect the NW 8 vacuum connector to the suction port.
5. Connect the exhaust pipe to the pressure connection.
6. Connect the diaphragm pump to the electrical supply.

5.3 Operation

Observe the basic safety instructions when using the pump.

The diaphragm pump is switched on and off at the operating switch.

The operating company must install a main switch for pumps with terminal boxes.

5.4 Storage

The pumps are to be stored in a low-dust, interior room within the temperature range from + 5 to + 40 °C and at a relative air humidity < 90% .

Leave the protective elements on the suction and pressure ports. Another equally good protection may be used.

5.5 Scrap Disposal

	CAUTION !
<p>The diaphragm pumps must be disposed of in accordance with the 2012/19/EU guideline and the specific national regulations. Contaminated diaphragm pumps must be decontaminated according to the laws.</p>	

Maintenance and Servicing

6 Maintenance and Servicing

6.1 General Requirements

- Check the pump daily for unusual running noises and heat building up on the surface of the pump.
- We recommend changing the diaphragm after 10,000 operating hours. The user may specify that the exchange be made earlier, depending upon the application process.
- Check the electrical and vacuum connections daily.

6.2 Maintenance Performed by the User

	WARNING !
<p>Only perform the work that is described here, and that which is permitted to be done by the user. All other maintenance and service work may only be performed by the manufacturer or a dealer authorized by him. Beware of the pump parts being possibly contaminated by hazardous substances. Wear protective clothing if there is contamination.</p>	

Scope of permissible work:

- Loosen and remove the hoses
- Open and remove the pump heads
- Inspect the pump chambers, diaphragms and valves
- Deposits in the inside of the pump must be cleaned out
- Change the diaphragms, valves and seals

Tools required:

Tool kit: Order no. 402106, consists of:

- Order no. 826801 Pin type face wrench, adjustable, size 3,
- Order no. 826801-6 Allan key, size 4,
- Order no. 826801-5 Open spanner, size 17.

6.2.1 Disassembly

1. Disconnect the power supply and ensure that it cannot be switched on again.
2. Open the screw clamps of the hoses on the pump body with the SW 17 open spanner.
3. Remove four machine screws **(1)** from each connection head with an Allan key, size 4.
4. Lift off the pressure plate **(2)**, the connection head **(3)** and the pump head **(6)**. The valve gasket **(5)** and diaphragm **(8)** are now freely exposed.
5. Loosen the diaphragm **(8)** at the strain washer **(7)** by turning the size 3 pin type face wrench anticlockwise.
6. Clean the valve gasket **(5)** the pump head **(6)** and the diaphragm **(8)** with a soft cloth and acetone.
7. Check that the drive is in good working order.

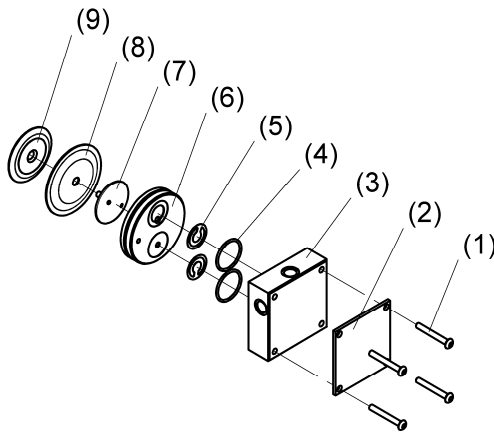

Fig. 5 Disassembly, assembly

	WARNING !
<p>Renew defective parts, if necessary! Wear protective gloves! Parts must be renewed at the intervals stated in this Operating Manual or as specified by the user internally! Do not clean with compressed air!</p>	

6.2.2 Assembly (see Fig. 5)

1. Place the pump so that the diaphragm is lying in a horizontal position.
2. Use the size 3 pin-type face wrench to tighten the pressure disc **(9)**, the diaphragm **(8)** and the strain washer **(7)** with the correct torque of 5 - 6 Nm.
3. Bring the connecting rod **(5)** (see Fig. 6) and the diaphragm **(8)** into the central position.
4. Replace the pump head **(6)**.
5. Insert the valve **(5)** and the O-ring **(4)**.
Ensure that they are lying completely flat. Do not insert the burred side facing the sealing surface. Align the connection head flush with the pin.
6. Replace the pressure plate **(2)** and insert and tighten the 4 machine screws with a torque of 3 - 4 Nm.
7. Reattach the hose connections with clamping ring screw fittings.

Maintenance and Servicing

6.2.3 Test

- Connect a vacuum measuring device to the suction connector and measure the ultimate pressure.
If the device is working properly, then the figure stated in the technical data must be attained within a maximum of one minute.
- The pump must not make any abnormal noises.
- Moving parts must not touch each other.

6.3 Maintenance by the Manufacturer

Repairs and maintenance going beyond the extent of the work described *in chapter 6.2* or reconditioning or modification may only be performed by the manufacturer or authorized workshops.

	WARNING !
The user shall be liable for the consequences of an incorrect damage report or a contaminated pump. The statements in the damage report are legally binding.	

6.4 Damage Report

You find the form of the damage report to the Download on our web page in the menu "service" and "Downloads". www.gardnerdenver.com/de-de/welch
If you should not have an entrance to the Internet, you can request the form also gladly with us, under phone +49 3677 604 0.

	WARNING !
Incomplete or incorrectly completed damage reports may endanger the service personnel! Give full information in the damage report, in particular regarding a possible contaminating.	

7 Troubleshooting

Only manufacturing firm and authorized service workshops may work on the diaphragm pump and their accessories during the warranty period.

Trouble	Cause	Remedy	
		by:	with:
Vacuum pump does not start	No power supply	Qualified electrician	Check electrical installation
	Motor defective	Service workshop	Exchange
	Pump body defective		Repair and/or exchange
Vacuum pump does not generate a vacuum or only an inadequate one	Connected apparatus and/or connecting elements leaking	User or Service workshop	Identify and seal the leak, replace the seals and/or hoses if necessary.
	Vacuum pump leaking		Check the hose connections between the pump heads; replace the hoses and/or fittings if necessary.
	Pump head leaking	Service workshop	Repair and/or exchange
	Diaphragm defective	User or Service workshop	Exchange of the diaphragm (see chapter 6.2)
	Valve defective		Exchange of the valve (see chapter 6.2)
	Vacuum pump dirty		General maintenance / cleaning
	Valves dirty		Cleaning condensates and foreign objects out of the valves.
Running noise	Vacuum pump dirty	User or Service workshop	General maintenance / cleaning
Cable(s)	defective and/or brittle	Qualified electrician	Exchange of the cable(s)

Spare Parts Overview

8 Spare Parts Overview

The spare parts lists contain all the spare parts and all the information necessary for ordering.

When ordering, please quote the description, quantity, serial number and order number!

	CAUTION !
We are not liable for any damage caused by the installation of any parts not supplied by the manufacturer.	

8.1 Service kit

Designation	Order no.
Service kit	402008

The service kit consists of:

Designation	Piece	Order no.
O-Ring \varnothing 28 x 2	4	829252-2
O-Ring \varnothing 12 x 2	3	829217-3
O-Ring \varnothing 8 x 2	2	829210-3
Valve	4	400656
Diaphragm	2	400822-2

Caution, the number of supplied construction units in the service kit corresponds to the maximum need of the series!

8.2 Spare parts view

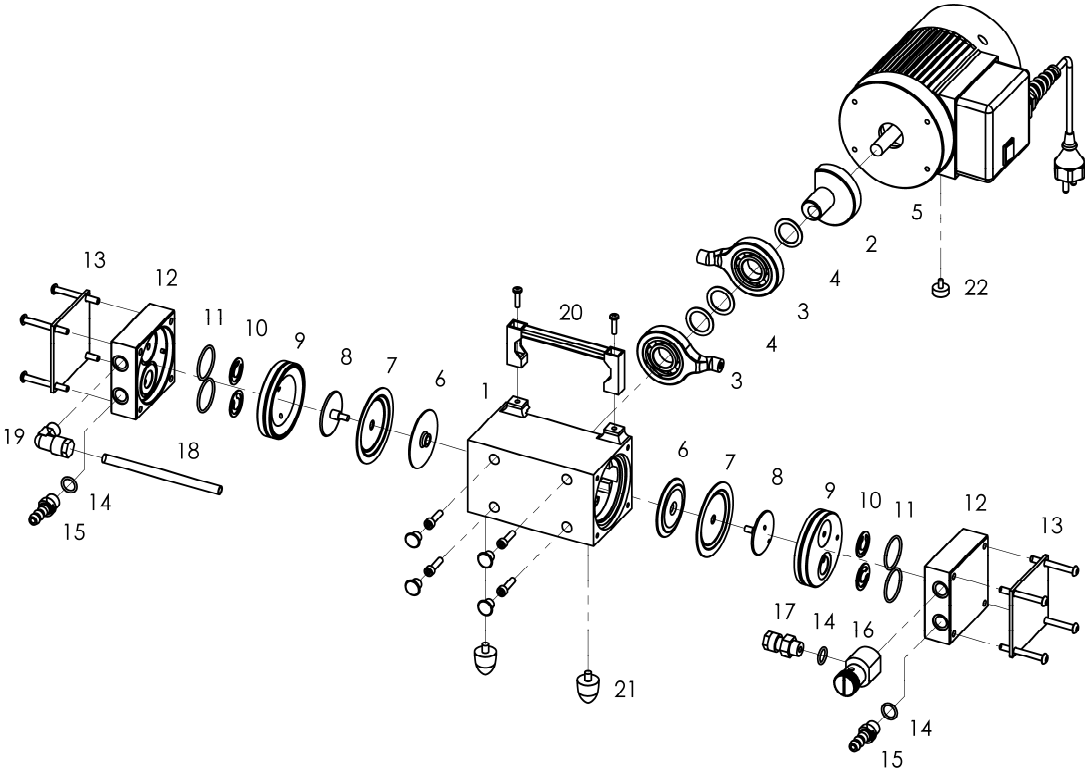

Fig. 6 Exploded view (MPC 101 Z)

Spare Parts Overview

8.2.1 Spare parts list diaphragm pumps MP 101 Z

Item no.	Designation	Piece	MP 101 Z	
			230 V	115 V
			411522	411522-01
			Order no.	Order no.
- *)	Basic pump complete (consisting of position: 1 – 5)	1	410301	410301-01
1	Pump casing	1	400764	400764
-	Drive complete (consisting of position: 2 – 4)	1	400763-01	400763-01
2	Eccentric	1	400770	400770
3	Piston rod with ball bearing	2	400771-01	400771-01
4	Close tolerance spacer 25 x 35 x 1	3	824957-2	824957-2
5	Alternating-current motor	1	826456	826456-2
	IEC power cable extension	1	825882-1	-
-	Mains connection cable IEC with plug CEE (D)	1	825885	-
	Mains connection cable IEC with plug BS (UK)	1	825878	-
	Mains connection cable IEC with plug NEMA 1-15 (US)	1	-	825903
6	Pressure washer	2	400772-1	400772-1
7	Diaphragm	2	400822-2	400822-2
8	Tightening washer	2	400773-3	400773-3
9	Pump head 1	2	400768	400768
10	Valve	4	400656	400656
11	O-Ring EPDM ø 28 x 2	4	829252-2	829252-2
12	Connecting head 1	2	410320	410320
13	Pressure plate	-	-	-
14	O-Ring EPDM ø 12 x 2	2	829217-3	829217-3
15	Hose nozzle PP, DN 8 - 1/4"	2	710798	710798
16	Gas ballast valve	-	-	-
17	Straight threaded joint with seal edge PVDF, 8 - 1/4"	-	-	-
18	Vacuum hose PTFE, 8 / 6x1 mm	0.2 m	828331	828331
19	Threaded elbow joint PVDF, 8 - 1/4"	2	829929	829929
20	Handle	1	828631	828631
21	Rubber-metal pad 20 x 24	2	829124-1	829124-1
22	Rubber-metal pad 15 x 6	2	829127	829127
-	Exhaust silencer 1/4"	1	829901	829901

*) The "basic pump" module (items 1 – 5) can only be supplied complete under order number 410301 or 410301-01.

8.2.2 Spare parts list diaphragm pumps MP 201 E

Item no.	Designation	Piece	MP 201 E	
			230 V	115 V
			411521	411521-01
			Order no.	Order no.
- *)	Basic pump complete (consisting of position: 1 – 5)	1	410301	410301-01
1	Pump casing	1	400764	400764
-	Drive complete (consisting of position: 2 – 4)	1	400763-01	400763-01
2	Eccentric	1	400770	400770
3	Piston rod with ball bearing	2	400771-01	400771-01
4	Close tolerance spacer 25 x 35 x 1	3	824957-2	824957-2
5	Alternating-current motor	1	826456	826456-2
	IEC power cable extension	1	825882-1	-
-	Mains connection cable IEC with plug CEE (D)	1	825885	-
	Mains connection cable IEC with plug BS (UK)	1	825878	-
	Mains connection cable IEC with plug NEMA 1-15 (US)	1	-	825903
6	Pressure washer	2	400772-1	400772-1
7	Diaphragm	2	400822-2	400822-2
8	Tightening washer	2	400773-3	400773-3
9	Pump head 1	2	400768	400768
10	Valve	4	400656	400656
11	O-Ring EPDM ø 28 x 2	4	829252-2	829252-2
12	Connecting head 1	1	410320	410320
	Connecting head 2	1	410321	410321
13	Pressure plate	-	-	-
14	O-Ring EPDM ø 12 x 2	2	829217-3	829217-3
	O-Ring EPDM ø 8 x 2	1	829210-3	829210-3
15	Hose nozzle PP, DN 8 - 1/4"	1	710798	710798
	Intake connection DN 8 – 1/4" – 1/8"	1	720608	720608
16	Gas ballast valve	-	-	-
17	Straight threaded joint with seal edge PVDF, 8 - 1/4"	1	829919-1	829919-1
	Straight threaded joint with seal edge PVDF, 8 - 1/8"	1	829919	829919
18	Vacuum hose PTFE, 8 / 6x1 mm	0.2 m	828331	828331
19	Threaded elbow joint PVDF, 8 - 1/4"	2	829929	829929
20	Handle	1	828631	828631
21	Rubber-metal pad 20 x 24	2	829124-1	829124-1
22	Rubber-metal pad 15 x 6	2	829127	829127
-	Exhaust silencer ¼"	1	829901	829901
-	Extension	1	400752-1	400752-1

*) The "basic pump" module (items 1 – 5) can only be supplied complete under order number 410301 or 410301-01.

Spare Parts Overview

8.2.3 Spare parts list diaphragm pumps MPC 101 Z

Item no.	Designation	Piece	MPC 101 Z		
			230 V	115 V	100 V
			412522 412522-40	412522-01	412522-04
			Order no.	Order no.	Order no.
- *)	Basic pump complete (consisting of position: 1 – 5)	1	410301	410301-01	410301-04
1	- Pump casing	1	400764	400764	400764
-	- Drive complete (consisting of position: 2 – 4)	1	400763-01	400763-01	400763-01
2	- Eccentric	1	400770	400770	400770
3	- Piston rod with ball bearing	2	400771-01	400771-01	400771-01
4	- Close tolerance spacer 20x28x1	3	824957-2	824957-2	824957-2
5	Alternating-current motor	1	826456	826456-2	826456-6
	IEC power cable extension	1	825882-1	-	-
-	Mains connection cable IEC with plug CEE (D)	1	825885	-	-
	Mains connection cable IEC with plug BS (UK)	1	825878	-	-
	Mains connection cable IEC with plug China GB1002	1	825909	-	-
	Mains connection cable IEC with plug NEMA 1-15 (US)	1	-	825903	-
	Mains connection cable IEC with plug JIS (J)	1	-	-	825911
6	Pressure washer	2	400772-1	400772-1	400772-1
7	Diaphragm	2	400822-2	400822-2	400822-2
8	Tightening washer	2	400773-3	400773-3	400773-3
9	Pump head 1	2	400768	400768	400768
10	Valve	4	400656	400656	400656
11	O-Ring EPDM ø 28 x 2	4	829252-2	829252-2	829252-2
12	Connecting head 1	2	400767	400767	400767
13	Pressure plate	2	400769	400769	400769
14	O-Ring EPDM ø 12 x 2	3	829217-3	829217-3	829217-3
15	Hose nozzle PP, DN 8 - 1/4"	2	710798	710798	710798
16	Gas ballast valve	1	400599	400599	400599
17	Straight threaded joint with seal edge PVDF, 8 - 1/4"	1	829919-1	829919-1	829919-1
18	Vacuum hose PTFE, 8 / 6x1 mm	0.2 m	828331	828331	828331
19	Threaded elbow joint PVDF, 8 - 1/4"	1	829929	829929	829929
20	Handle	1	828631	828631	828631
21	Rubber-metal pad 20 x 24	2	829124-1	829124-1	829124-1
22	Rubber-metal pad 15 x 6	2	829127	829127	829127

*) The "basic pump" module (items 1 – 5) can only be supplied complete under order number 410301, 410301-01 or 410301-04.

8.2.4 Spare parts list diaphragm pumps MPC 201 E

Item no.	Designation	Piece	MPC 201 E		
			230 V	115 V	100 V
			412521	412521-01	412521-04
			Order no.	Order no.	Order no.
- *)	Basic pump complete (consisting of position: 1 – 5)	1	410301	410301-01	410301-04
1	Pump casing	1	400764	400764	400764
-	Drive complete (consisting of position: 2 – 4)	1	400763-01	400763-01	400763-01
2	Eccentric	1	400770	400770	400770
3	Piston rod with ball bearing	2	400771-01	400771-01	400771-01
4	Close tolerance spacer 25x35x1	3	824957-2	824957-2	824957-2
5	Alternating-current motor	1	826456	826456-2	826456-6
	IEC power cable extension	1	825882-1	-	-
-	Mains connection cable IEC with plug CEE (D)	1	825885	-	-
	Mains connection cable IEC with plug BS (UK)	1	825878	-	-
	Mains connection cable IEC with plug NEMA 1-15 (US)	1	-	825903	-
	Mains connection cable IEC with plug JIS (J)	1	-	-	825911
6	Pressure washer	2	400772-1	400772-1	400772-1
7	Diaphragm	2	400822-2	400822-2	400822-2
8	Tightening washer	2	400773-3	400773-3	400773-3
9	Pump head 1	2	400768	400768	400768
10	Valve	4	400656	400656	400656
11	O-Ring EPDM ø 28 x 2	4	829252-2	829252-2	829252-2
12	Connecting head 1	1	400767	400767	400767
	Connecting head 2	1	400845	400845	400845
13	Pressure plate	2	400769	400769	400769
14	O-Ring EPDM ø 12 x 2	1	829217-3	829217-3	829217-3
	O-Ring EPDM ø 8 x 2	2	829210-3	829210-3	829210-3
15	Intake-/Exhaust connection PP DN 8 - 1/4" – 1/8"	2	720608	720608	720608
16	Gas ballast valve	1	400599	400599	400599
17	Straight threaded joint with seal edge PVDF, 8 - 1/4"	1	829919-1	829919-1	829919-1
	Straight threaded joint with seal edge PVDF, 8 - 1/8"	2	829919	829919	829919
18	Vacuum hose PTFE, 8 / 6x1 mm	0.2 m	828331	828331	828331
19	Threaded elbow joint PVDF, 8-1/4"	1	829929	829929	829929
20	Handle	1	828631	828631	828631
21	Rubber-metal pad 20 x 24	2	829124-1	829124-1	829124-1
22	Rubber-metal pad 15 x 6	2	829127	829127	829127

*) The "basic pump" module (items 1 – 5) can only be supplied complete under order number 410301, 410301-01 or 410301-04.

Instructions for ATEX Certification - Diaphragm Pumps MPC - for use in Zone 2 in accordance with device category 3 per ATEX Directive 2014/34/EU

**« EX II 3G IIC T3X »
Internal atmospheres only**

1. Type test – Effects of the ATEX Directive

Thanks to its design this device meets the requirements imposed upon devices of device group II and device category 3 in conformity with Directive 2014/34/EU of the European Parliament and Council dated 26 February 2014 on the harmonisation of the legislation and administrative regulations of the member states with regard to devices and protection systems for use in atmospheres capable of being ignited. According to the regulations for category 3, these devices are intended to be connected to apparatus in which in normal operation a mixture of gases or vapours capable of being ignited does not normally occur or with a high probability does so only seldom and briefly.

The following instructions absolutely must be observed when using these devices.

- Because of the identical construction in principle of the devices of category 2 certified by IBExU (notified body), these studies relating to the internal space are used for illustration purposes.

This certification relates to the following device models:

The certification is a type test per Directive 2014/34/EU. It relates to all the devices of the manufacturer "Gardner Denver Thomas GmbH" with the designation "EX II 3G IIC T3X."

In the specific case these are devices with the following type designations:

- **MPC...** with a membrane diameter of 75 mm, 95 mm and 97 mm. (Annex III)

E = one-stage:	201; 601; 1201; 2401; 602
Z = two-stage:	101; 301; 901; 1801; 301ef; 302
T = three-stage:	201; 601; 1201; 601ef; 1201ef, 602; 602ef
V = four-stage:	301

The certification relates to all versions including those that vary from the basic types. A precondition here is that the internal area in contact with the gas has not been changed.

Legend:

- MPC - Designation
- EX - ATEX Directive 2014/34/EU
- 03 - Device category 3
- 01 - Serial number of the internal certification

Instructions for ATEX Certification

The “EX II 3G IIC T3X” certification is valid only for the internal space in contact with the medium and the transport of gases and vapours. Installation and operation of the devices in an atmosphere capable of being ignited is not permitted.

The user should note that if accessories or components are added, the use of the above-mentioned devices in plant entails recertification to ATEX. In this event, the certification of the Gardner Denver Thomas GmbH devices lapses.

According to the definition in DIN “Device Category 3”, these devices are designed for use where in normal operation a mixture of gases or vapours capable of being ignited does not normally occur or with a high probability does so only seldom and briefly.

The use of built-in gas ballast valves or other devices for the intake of air to check for leaks is only permitted if this does not generate any mixtures capable of being ignited in the internal space of the device.

Restrictions on the operating conditions as a result of designating the devices with an “X” (in accordance with EN 13463-1 see Assessment of the risk of ignition).

- Devices are to be installed in such a manner that they cannot be damaged, heat is conducted away and visual monitoring is possible.
- The tolerances relating to ambient and gas intake temperatures in the operating instructions are to be observed.
- After maintenance or repair work has been carried out, the device concerned must be subjected to an appropriate inspection. The final vacuum stated in the documentation and a test on the seal of the internal space of the device are to be checked.

The tested leak rate may not be under 0.5×10^{-2} mbar x litres/sec.

2. Definition of explosive atmosphere

An atmosphere capable of being ignited is a mixture of air and combustible substances in the form of gases, vapours, mists or dust under atmospheric conditions in which, following ignition, the combustion process is transferred to the entire uncombusted mixture.

3. Area with a risk of explosion

By an area with a risk of explosion is meant an area in which the atmosphere may be capable of being ignited because of the local and operating conditions.

Note:

The allocation of hazardous areas is a matter for the user.

4. Legal requirements for the manufacturer

Directive 2014/34/EU Legal requirements for the manufacturer are set out in:

- National implementation of the EX Decree
- DIN EN 1127-1
- DIN EN 50014-x
- DIN EN 13463-x
- IEC EN 60079-x
- IEC EN 61241-x

5. Legal requirements for the operating company

Directive 1999/92/EC (ATEX 137) Legal requirements for the operating company are set out in:

- Implementation by the Operational Safety Decree
- BGR 104 and BGR 132
- TRBS 2152 /TRGS 720
- TRBS 2152-1 /TRGS 721
- TRBS 2152-2 /TRGS 722

Instructions for ATEX Certification

Legend:

- (BGR - Trade association regulations
TRBS - Technical regulations for operational safety
TRGS - Technical regulations for hazardous substances)

6. General concepts regarding the operating company

The operating company is responsible for:

- Performing an assessment of the existing zone
- Selecting the appropriate operating equipment in the relevant device category
- Observing the installation regulations
- Ensuring compliance with safety requirements
- Producing the explosion protection document
- Observing the procedure for checking the safety measures.

7. Legal requirements

Further legal requirements are to be found in Directive 98/24/EC and Ordinance on Hazardous Substance Decree §12.

8. Surface temperature

The maximum permitted surface temperature of the devices is allocated to classes T1 to T6. The permitted temperature for the stated temperature class T3 is 200°C.

The user must perform the assessment of the individual substances with regard to their ignition temperature on the basis of his knowledge.

9. Conformity assessment

The conformity assessment for devices of category 3 of device group II and “EX II 3G IIC T3 X” certification is conducted by the in-house Production Inspection in accordance with the specifications set out in the documentation. Individual inspections are to be conducted. A complete record of the results for every device is to be stored in the PPS system.

Maintenance and repair

After repair or maintenance work has been carried out, the pump must be subjected to an inspection. One inspection criterion is final pressure. If this is reached, it may be assumed that the leakage of the device lies within the required tolerance. This ensures that there is no mixture capable of being ignited within the internal space of the pump.

10. Technical documents for the EC type test

1. Risk assessment
2. Test certificate
3. Internal inspection and production inspection of the products
4. Declaration of conformity (CE)
5. Designation on the rating plate
6. Additional statement in the valid operating instructions on the usability of the MPC types as devices of category 3 in zone 2 (Internal atmospheres only).

EG - Konformitätserklärung

EC Declaration of Conformity / CE Déclaration de Conformité

DE: Hiermit erklären wir	 by Gardner Denver	Gardner Denver Thomas GmbH Am Vogelherd 20 98693 Ilmenau Germany	T +49 3677 604 0 F +49 3677 604 131 welch.emea@gardnerdenver.com www.gardnerdenver.com/de-de/welch
--	--	--	--

unter eigener Verantwortung, dass nachstehendes Produkt aufgrund seiner Konzipierung und Bauart sowie in den von uns in Verkehr gebrachten Unterlagen den nachfolgend aufgeführten EG-Richtlinien und Normen entspricht.
 Bei einer nicht mit uns abgestimmten Änderung des Produkts verliert diese Erklärung ihre Gültigkeit.

EN:	We (Gardner Denver Thomas GmbH) herewith declare under our sole responsibility that the product described below is in accordance with the following Directives standards and other technical specifications regarding design and version when delivered from our factory. This declaration becomes invalid whenever the product has been modified without our consent.
FR:	Nous (Gardner Denver Thomas GmbH) certifions par la présente, que le produit décrit ci-après est conforme, tant dans sa conception que dans sa réalisation, aux normes de sécurité et d'hygiène exigées par les standards de la CE. En cas de modification du produit sans notre accord, cette déclaration devient caduque.

Bezeichnung des Produkts (Pumpen / Pumpstände) Description of product (pumps / pump systems) Description du produit (pompes / pompe systèmes)	Membranpumpen / Diaphragm pumps / Pompes à membrane MP 201 E, MP 101 Z, MPC 201 E, MPC 101 Z
Artikel-Nr. / Fabrication No. / No. de fabrication	411521, 411521-01, 411521-06, 411522, 411522-01 412521, 412521-01, 412521-04, 412522, 412522-01, 412522-04, 412522-40

Das Produkt entspricht folgenden Richtlinien und Normen: / The product is in conformity with the following Directives and standards: / *Le produit est conforme aux directives et standards suivants:*

X	2006/42/EG	Maschinenrichtlinie / EC machinery directive / <i>directive CE sur les machines</i> (17.05.2006)
X	2014/34/EU	ATEX-Richtlinie für Verwendungen in explosionsgefährdeten Bereichen, Anhang III / ATEX Guideline for use in potentially explosive atmospheres, Appendix III / <i>ATEX Directive for applications in hazardous areas, Annex III</i>
X	2014/30/EU	Elektromagnetische Verträglichkeit / EC Electromagnetic Compatibility Directive / <i>Directive CE relative à la compatibilité électromagnétique</i>
X	2011/65/EU	Gefährliche Stoffe in Elektro- und Elektronikgeräten (RoHS II) / Dangerous materials in electrical and electronics devices (RoHS II) / <i>Substances dangereuses dans les appareils électriques et électroniques (RoHS II)</i>
X	2012/19/EU	Elektro- und Elektronik - Altgeräte (WEEE) / Electrical and electronics - old devices (WEEE) / <i>Électro et électronique - appareils de contrôle (WEEE)</i>
X	China – RoHS II	Umweltschutzgesetz – China 2007-03 / Environment protection law / <i>Loi sur la protection de environnement</i>

Angewandte harmonisierte Normen: / Applied harmonized standards: / *Standards appliqués et harmonisés:*

X	DIN EN 1127-1: 2011-10	Explosionsfähige Atmosphären – Explosionsschutz - Teil 1: Grundlagen und Methodik / Explosive atmospheres - Explosion prevention and protection - part 1: Basic concepts and methodology / <i>Atmosphères explosives - Protection contre les explosions - partie 1 : prescriptions et méthodologie</i>
X	DIN EN 13463-1: 2009-07	Nicht-elektrische Geräte für den Einsatz in explosionsgefährdeten Bereichen - Teil 1: Grundlagen und Anforderungen / Non-electrical equipment for use in potentially explosive atmospheres - part 1: Basic method and requirements / <i>Appareils non électriques destinés à être utilisés en atmosphères explosives - partie 1 : prescriptions et méthodologie</i>
X	DIN EN 13463-5: 2011-10	Nicht-elektrische Geräte für den Einsatz in explosionsgefährdeten Bereichen - Teil 5: Schutz durch konstruktive Sicherheit 'c' / Non-electrical equipment for use in potentially explosive atmospheres - part 5: Protection by constructional safety 'c' / <i>Appareils non électriques destinés à être utilisés en atmosphères explosives - partie 5 : protection par sécurité de construction « c »</i>
X	DIN EN ISO 12100: 2011-03	Sicherheit von Maschinen - Allgemeine Gestaltungsleitsätze Risikobeurteilung und Risikominderung / Safety of machinery - General principles for design - Risk assessment and risk reduction / <i>Sécurité des machines - / Principes généraux pour l'évaluation des risques et la réduction des risques</i>
X	DIN EN ISO 13857: 2008-06	Sicherheit von Maschinen - Sicherheitsabstände gegen das Erreichen von Gefährdungsbereichen mit den oberen und unteren Gliedmaßen / Safety of machinery - Safety distances to prevent hazard zones being reached by upper and lower limbs / <i>Sécurité des machines - Distances de sécurité empêchant les membres supérieurs et inférieurs d'atteindre les zones dangereuses</i>
X	DIN EN 1012-2: 2011-12	Kompressoren und Vakuumpumpen - Sicherheitsanforderungen - Teil 2: Vakuumpumpen / Compressors and vacuum pumps - Safety requirements - part 2: Vacuum pumps / <i>Compresseurs et pompes à vide - Exigences de sécurité - partie 2: pompes à vide</i>
X	DIN EN ISO 2151: 2009-01	Akustik - Geräuschemessnorm für Kompressoren und Vakuumpumpen - Verfahren der Genauigkeitsklasse 2 / Acoustics - Noise test code for compressors and vacuum pumps – Engineering method (grade 2) / <i>Acoustique - norme de mesure des émissions pour les compresseurs et les pompes à vide - Procédé de classe de précision 2</i>
X	DIN EN 60204-1: 2014-10	Sicherheit von Maschinen - Elektrische Ausrüstung von Maschinen - Teil 1: Allgemeine Anforderungen / Safety of machinery - Electrical equipment of machines - part 1: General requirements / <i>Sécurité des machines - Equipement électrique des machines - partie 1: Prescriptions générales</i>
X	EN 61000-6-2: 2011-06	Elektromagnetische Verträglichkeit (EMV) - Teil 6-2: Fachgrundnormen - Störfestigkeit für Industriebereiche / Electromagnetic compatibility (EMC) - part 6-2: Generic standards - Immunity for industrial environments / <i>Compatibilité électromagnétique (EMV) - partie 6-2: Normes génériques - Immunité pour les environnements industriels</i>
X	EN 61000-6-4: 2011-09	Elektromagnetische Verträglichkeit (EMV) - Teil 6-4: Fachgrundnormen - Störaussendung für Industriebereiche / Electromagnetic compatibility (EMC) - part 6-4: Generic standards - Emission standard for industrial environments / <i>Compatibilité électromagnétique - partie 6-4: Normes génériques - Emissions de parasites pour les activités industrielles</i>
X	DIN EN 50110-1: 2014-02	Betrieb von elektrischen Anlagen / Operation of electrical installations / <i>Fonctionnement des installations électriques</i>
X	DIN EN 61010-1/A1:2015-04	Sicherheitsbestimmungen für elektrische Mess-, Steuer-, Regel- und Laborgeräte - Teil 1: Allgemeine Anforderungen / Safety requirements for electrical equipment for measurement, control and laboratory use - part 1: General requirements / <i>Consignes de sécurité pour les appareils électriques de mesure, de commande, de régulation ou de laboratoire - partie 1: Prescriptions générales</i>

Bevollmächtigter Vertreter mit Sitz in der Europäischen Gemeinschaft und Person, die befugt ist, die technischen Unterlagen zu erstellen. / Authorized representative established in the European Community and person, who is authorized to compile the technical file. / *Représentant autorisé établi dans la Communauté européenne et personne autorisée à établir la documentation technique.*

Gardner Denver Thomas GmbH Am Vogelherd 20 98693 Ilmenau / Germany	Datum / Data 2019-09-04	
Werksleiter / Plant manager / <i>Directeur d'usine</i>	Name / Name / Nom Robert Götz	