

**memmert**

# Operating manual



**WTB**

WTB water bath

---

## About this manual

---

### Purpose and target audience

This manual describes the design, function, transport, operation and maintenance of WTB water baths. It is intended for use by trained personnel of the owner, who have the task of operating and/or maintaining the respective appliance. If you are asked to work on the appliance, read this manual carefully before starting. Familiarise yourself with the safety regulations. Only perform work that is described in this manual. If there is something you do not understand, or certain information is missing, ask your manager or contact the manufacturer. Do not do anything without authorisation.

### Versions

The appliance is available in different configurations and sizes. If specific equipment features or functions are available only for certain configurations, this is indicated at the relevant points in this manual. The functions described in this manual refer to the latest firmware version. Due to individual configurations and sizes, illustrations in this manual may be slightly different to the actual appearance. Function and operation are identical.

### Other documents to be observed:

- For service and repair work, observe the separate service manual
- separate operating manual for accessory parts, such as shaking device, cooling unit and circulation pump device

### Storage and resale

This operating manual belongs with the appliance and should always be stored where persons working on the appliance have access to it. It is the owner's responsibility to ensure that persons who are working on or are going to work on the appliance know where to find the operating manual. We recommend that it is always stored in a protected location close to the appliance. Make sure that the operating manual is not damaged by heat or humidity. If the appliance is resold or transported and then set up again at a different location, the operating manual must remain with it. The current version of this operating manual in PDF format is also available for download from <http://www.memmert.com/>

### Manufacturer address and customer service

MEMMERT GmbH + Co. KG  
Willi-Memmert-Str. 90-96  
91186 Büchenbach  
Germany

Phone: +49 (0)9122 925-0  
Fax: +49 (0)9122 14585  
E-mail: [sales@memmert.com](mailto:sales@memmert.com)  
Internet: [www.memmert.com](http://www.memmert.com)

Customer service:  
Hotline: +49 (0)9171 9792 911  
Service fax: +49 (0)9171 9792 979  
Email: [service@memmert.com](mailto:service@memmert.com)

For service enquiries, please always specify the appliance number given on the type plate.

# Content

---

<b>1. Safety</b>	<b>5</b>
1.1 Terms and signs used .....	5
1.2 Product safety and dangers .....	6
1.3 Requirements of the operating personnel .....	7
1.4 Responsibility of the owner .....	7
1.5 Intended use .....	7
1.6 Changes and alterations .....	7
1.7 Behaviour in case of malfunctions and irregularities .....	8
1.8 Switching off the appliance in an emergency .....	8
<b>2. Construction and description</b>	<b>8</b>
2.1 Design .....	8
2.2 Description .....	9
2.3 Material .....	9
2.4 Electrical equipment .....	10
2.5 Connections and interfaces .....	10
2.6 Designation (nameplate) .....	10
2.7 Technical data .....	11
2.8 Applied directives and standards .....	12
2.9 Ambient conditions .....	12
2.10 Scope of delivery .....	12
<b>3. Delivery, Transport and Setting Up</b>	<b>13</b>
3.1 Safety .....	13
3.2 Delivery/unpacking .....	13
3.3 Disposing of packaging material .....	14
3.4 Setting up .....	14
3.5 Lid assembly (accessories) .....	15
<b>4. Putting into operation</b>	<b>16</b>
4.1 Putting into operation for the first time .....	16
4.2 Connect the appliance to the power supply .....	16
4.3 Filling .....	16
4.4 Water specifications .....	17
4.5 Switching on appliance .....	17
<b>5. Operation and control</b>	<b>18</b>
5.1 Home screen .....	18
5.2 Setting the temperature and time .....	18
5.3 Settings .....	18
5.4 Outlet valve .....	21
5.5 Calibration .....	21
<b>6. Malfunctions, warning and error messages</b>	<b>24</b>

---



7. Maintenance and Servicing	25
7.1 Cleaning .....	25
7.2 Regular maintenance.....	25
7.3 Repairs and service .....	26
8. Storage and disposal	27
8.1 Storage.....	27
8.2 Disposal .....	27

# 1. Safety











## 1.1 Terms and signs used

In this manual and on the appliance itself, certain common terms and signs are used to warn you of possible dangers or to give you hints that are important in avoiding injury or damage. Observe and follow these notes and regulations to avoid accidents and damage. These terms and signs are explained below.

### 1.1.1 Terms used

 <b>WARNING</b>	Warns of a dangerous situation that might lead to death or serious injuries.
 <b>CAUTION</b>	Warns of a dangerous situation that might lead to moderate or minor injuries.
 <b>NOTICE</b>	Warns of material damage

### 1.1.2 Signs used

Symbol	Meaning	Symbol	Meaning
	general warning sign		Gases / vapours
	Danger of electrocution		Danger of explosion
	Flammable substance warning		Caution: hot steam
	Caution: hot		Disconnect the mains plug
	Do not lift appliance		Use gloves
	Observe information in separate manual		

## 1.2 Product safety and dangers

The appliances described in this manual are technically sophisticated, manufactured using high-quality materials and subject to many hours of testing in the factory. They reflect the state of the art and comply with recognised technical safety regulations. However, there are still risks involved, even when the appliances are used as intended. These are described below.

### ⚠ WARNING



Live components may be exposed once the covers have been removed. Touching these can lead to an electric shock. Disconnect the mains plug before removing any covers. Work on the electrical system must only be performed by qualified electricians.

### ⚠ WARNING



When loading the appliance with an unsuitable load, poisonous or explosive vapours or gases may be produced. This could cause the appliance to explode, and persons could be severely injured or poisoned. The appliance may only be loaded with materials / test objects that do not emit any poisonous or explosive vapours when heated up.

### ⚠ WARNING



Operating without a tempering medium can cause the appliance to overheat and pose a fire hazard. Do not operate the water bath without a tempering medium. Always observe the minimum fill level for the tray.

### ⚠ WARNING



Depending on operation, the surfaces of the appliance and the chamber load may still be very hot after the appliance is switched off. Touching these surfaces can cause burns. Wear heat-resistant protective gloves or wait until the appliance cools down after switching off before touching.

### ⚠ WARNING



The drain valve can become overheated while emptying the water bath. Touching its surface can cause burns. Use heat-resistant protective gloves to turn the drain valve on/off or let the tempering medium cool down first and empty the water bath when it has reached a lukewarm temperature.

### ⚠ CAUTION



Hot steam can build up inside the appliance. You may be scalded when opening the lid or coming into close contact with the surface of the water. Keep a safe distance away from the water's surface when opening the lid and when removing.

### 1.3 Requirements of the operating personnel

The appliance may only be operated and maintained by persons who are of legal age and have been instructed accordingly. Personnel who are to be trained, instructed or who are undergoing general training may only work with the appliance under the continuous supervision of an experienced person. Repairs may only be performed by qualified electricians. The regulations in the separate service manual must be observed.

### 1.4 Responsibility of the owner

The owner of the appliance

- is responsible for the flawless condition of the appliance and for it being operated in accordance with its intended use;
- is responsible for ensuring that persons who are to operate or service the appliance are qualified to do this, have been instructed accordingly and are familiar with the operating instructions at hand;
- must know about the applicable guidelines, requirements and operational safety regulations, and train staff accordingly;
- is responsible for ensuring that unauthorised persons have no access to the appliance;
- is responsible for ensuring that the maintenance plan is adhered to and that maintenance work is properly carried out;
- has to ensure that the appliance and its surroundings are kept clean and tidy, for example through corresponding instructions and inspections;
- is responsible for ensuring that personal protective clothing is worn by operating personnel, e.g. work clothes, safety shoes and protective gloves.

### 1.5 Intended use

The Memmert waterbaths are intended for indirect tempering of samples or materials. Water is meant to be used as the tempering medium. A wide variety of samples are tempered in a range from approx. 5°C above room temperature to 100 °C. This can be done in suitable vessels such as test tubes, Erlenmeyer flasks etc., or if the sample to be tempered is suitable, in direct contact with the tempering medium.

It is not possible to include all possible applications. Application is at the operator's discretion and under their responsibility.

Any other use is improper and may result in hazards and damage. The appliance is not explosion-proof (does not comply with the German occupational health and safety regulation VBG 24). The appliance may only be loaded with materials and substances which cannot form any toxic or explosive vapours at the set temperature and which cannot explode, burst or ignite. The appliance may not be used for the drying, evaporation and burning-in of paints or similar materials, the solvents of which could form an explosive mixture when combined with air. If there is any doubt as to the composition of materials, they must not be loaded into the appliance. Potentially explosive gas-air mixtures must not form, neither in the working chamber nor in the direct vicinity of the appliance.

### 1.6 Changes and alterations

No unauthorised changes or alterations may be made to the appliance. No parts may be added or inserted which have not been approved by the manufacturer.

Unauthorised changes or alterations result in the CE declaration of conformity losing its validity, and the appliance may no longer be operated.

The manufacturer is not liable for any damage, danger or injuries that result from unauthorised changes or alterations, or from non-compliance with the provisions in this manual.

## 1.7 Behaviour in case of malfunctions and irregularities

The appliance may only be used in a flawless condition. If you, as the operator, notice irregularities, malfunctions or damage, immediately turn off the appliance and inform your superior. You can find information on troubleshooting in the chapter 6.

## 1.8 Switching off the appliance in an emergency

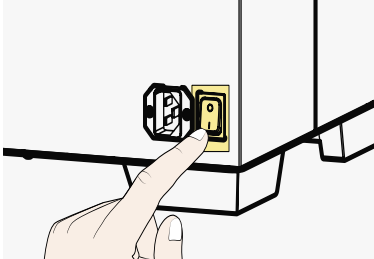

Push the On/Off switch on the appliance and disconnect power plug. This disconnects the appliance from the power supply at all poles.

# 2. Construction and description

## 2.1 Design

Description	Appliance overview
<ul style="list-style-type: none"> <li>1. Stainless steel tray</li> <li>2. Cooling fins</li> <li>3. Touch display 3.5"</li> <li>4. Outlet valve</li> </ul>	

Description	Overview of rear
<ul style="list-style-type: none"> <li>1. Mains plug</li> <li>2. Main switch</li> <li>3. Nameplate</li> <li>4. Mounting option Lid (accessory)</li> </ul>	



## 2.2 Description

### 2.2.1 Operation

The temperature control for the Memmert water baths is operated via a silicone heating mat. A digital sensor measures the temperature at the water bath tray. The water bath heating mat is resistant to damage through malfunctions or improper use. Dry-run protection switches the water bath off if it is operating without a tempering medium at about 180 °C. It also prevents the heating mat from overheating, for example, if the water bath runs empty while unsupervised.

## 2.3 Material

These appliances fulfil the current requirements of the RoHS Directive. For more information about this and about the Material Compliance of these Memmert GmbH+ Co.KG appliances in general, please visit our homepage at [www.memmert.com](http://www.memmert.com).

Components	Material
Housing (lid + side panel)	Stainless steel 1.4301 - ASTM 304
Interior (tray)	Stainless steel 1.4301 - ASTM 304
Accessories (bottom grid, shaking device, support basket, test tube racks, clamps)	Stainless steel 1.4301 - ASTM 304
Outlet valve	Stainless steel 1.4301 - ASTM 304
Screws and hinges	Stainless steel 1.4301 - ASTM 304
Drain system	Stainless steel 1.4301 - ASTM 304
Silicone hose	Silicone - Shore A translucent
Heating mat	Silicone

**i** The chamber load for the appliance must be carefully checked for chemical compatibility with the materials mentioned.

## 2.4 Electrical equipment

- Operating voltage and current consumption: See name plate or technical data
- Protection class I, i.e. operating insulation with PE conductor in accordance with EN 61010
- Protection type IP 20 acc. to EN 60 529
- Interference suppression acc. to EN 55011 class B
- Appliance fuse: Safety fuse 250 V/15 A, quick-blow
- Electronic overtemperature monitor
- Heating thermal fuse: 240°C 250V/15A

## 2.5 Connections and interfaces

### 2.5.1 Electrical connection

This appliance is intended for operation on an electrical power system with a system impedance  $Z_{max}$  at the point of transfer (service line) of a maximum of 0.292 Ohm. The operator must ensure that the appliance is operated only on an electrical power system that meets these requirements. If necessary, you can ask your local energy supply company what the system impedance is. Observe the country-specific regulations when making connections (e.g. in Germany DIN VDE 0100 with earth leakage circuit breaker).

## 2.6 Designation (nameplate)

The nameplate provides information about the appliance model, manufacturer and technical data. It is attached to the back of the appliance, on the right near the mains plug.

Description	Overview
1. Type designation	
2. Operating voltage	
3. Applied standard	
4. Protection type	
5. CE conformity	
6. Address of manufacturer	
7. Disposal note	
8. Nominal temperature	
9. Connection / power ratings	
10. Serial number	

## 2.7 Technical data

Model sizes			6	11	15	24	35	50	
Stainless steel interior	Volume	ap- prox. l	7.5	10	17.1	23.1	37.5	51	
	Length A	mm	277	267	482	472	602	592	
	Width B	mm	217	207	277	267	482	472	
	Height C	mm	150	200	150	200	150	200	
Structured stainless steel housing	Width D	mm	349		554		679		
	Height E1	mm	245	295	245	295	245	295	
	Height E2	mm	328	378	328	378	328	378	
	Depth F	mm	289		349		554		
Temperature	Adjustment precision	°C	0.1						
	Operating temperature range	°C	minimum 5 above ambient temperature to +100						
	Setting temperature range	°C	+10 to +100						
electrical data	Power	230 V; 50/60 Hz	W	1000			1420		2800
		115 V; 50/60 Hz							2000
	Current consumption	230 V; 50/60 Hz	A	4.4		6.2		12.2	
		115 V; 50/60 Hz	A	8.7		12.4		17.4	
Packaging data	Net weight	ap- prox. kg	6	7	9	10	14	16	
	Gross weight (in cardboard box)	ap- prox. kg	10	12	14	16	20	23	
	Length	mm	570	670			910		
	Width	mm	450		530		610		
	Height	mm	420	380	400	460	400	460	

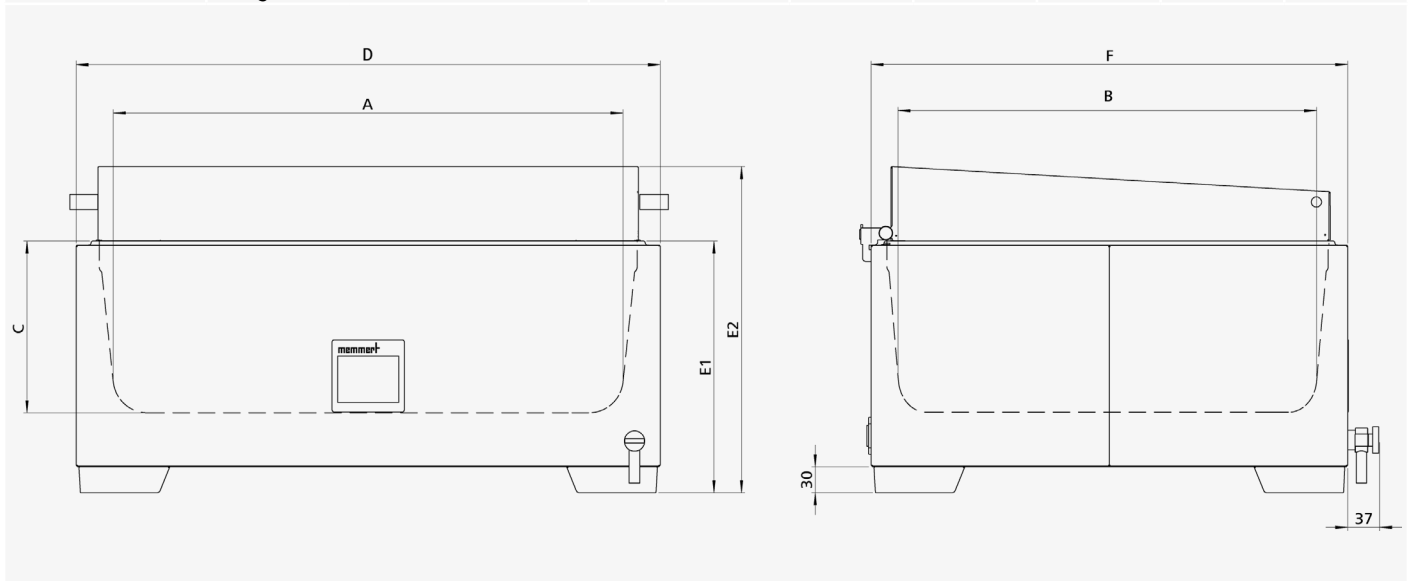

## 2.8 Applied directives and standards



- Directive 2014/30/EU amended (Directive of the council for harmonisation of the laws of the member states on electromagnetic compatibility)  
Standards complied with: DIN EN 61326-1:2013-07 and EN 61326-1:2013
- Directive 2014/35/EC amended (Directive of the council on harmonisation of the laws of member states relating to electrical equipment designed for use within certain voltage limits). Standards complied with:  
DIN EN 61010-1:2011-07 EN 61010-1:2010  
DIN EN 61010-2-010:2015-05 and EN 61010-2-010:2014

### 2.8.1 Declaration of conformity

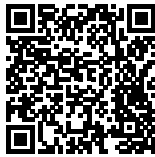

You can download the EC declaration of conformity of the appliance online under:

[www.memmert.com/de/downloads/downloads/eu-konformitaetserklaerung](http://www.memmert.com/de/downloads/downloads/eu-konformitaetserklaerung)

## 2.9 Ambient conditions

Ambient temperature	+5 °C to 40 °C
Air humidity	max. 80 % rh (non-condensing)
Overvoltage category	II
Pollution degree	2
Altitude of installation	max. 2,000 m above sea level

- The appliance may only be used in enclosed areas and under the ambient conditions listed below
- The appliance may not be used in areas where there is a risk of explosion. The ambient air must not contain any explosive dusts, gases, vapours or gas-air mixtures. The appliance is not explosion-proof.
- Heavy dust production or aggressive vapours in the vicinity of the appliance could lead to sedimentation in the interior and, as a consequence, could result in short circuits or damage to electrical parts. For this reason, sufficient measures to prevent large clouds of dust or aggressive vapours from developing should be taken.

## 2.10 Scope of delivery

### Standard

- Waterbath
- Network connection
- Quick guide

### Optional

- Gable/flat lid
- Floor grid
- Clamps, insert racks and test tube racks
- Peltier cooling unit
- Shaking Device
- Pumping device
- Factory calibration certificate
- IQ/OQ document with works test data for appliances

## 3. Delivery, Transport and Setting Up

### 3.1 Safety

#### ⚠ WARNING



Condensation in the electrical components may cause short circuits. After transporting or storing the appliance under humid conditions, remove it from its packaging and let it ventilate for at least 24 hours in normal ambient conditions. Do not connect the appliance to the mains power during this time.

#### ⚠ CAUTION



Because of the heavy weight of the appliance, you could injure yourself if you try to lift it. Observe the required number of people to carry equipment.

< 50 L



50 L



#### ⚠ CAUTION



The appliance could fall over and injure you. If a lid is mounted, do not transport the appliance while it is open. Never tilt the appliance and only transport it empty and in upright position.

#### ⚠ CAUTION



You may get your hands or feet squashed when transporting and installing the appliance. Wear protective gloves and safety boots. Only grasp the appliance below on the sides between the mounted adjustable feet.

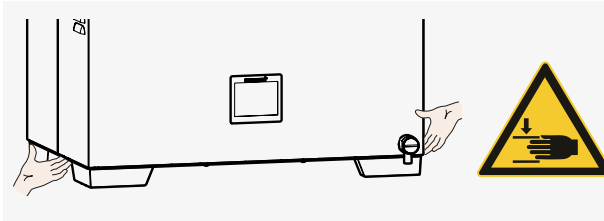

### 3.2 Delivery/unpacking

- The appliance is packed in a cardboard box
- To avoid damage, do not unpack the appliance until you reach the installation site.
- Remove the cardboard packaging by pulling it upwards or carefully cutting along an edge

### 3.2.1 Product control

- Check the delivery note to ensure that the scope of delivery is complete
- Check the appliance for damage

If you notice deviations from the scope of delivery, damage or irregularities, do not put the appliance into operation but inform the haulage company and the manufacturer.

### 3.3 Disposing of packaging material

- Dispose of the packaging material (cardboard, wood, foil) in accordance with the applicable disposal regulations for the respective material in your country

### 3.4 Setting up

#### ⚠ CAUTION



If the appliance is set up on an uneven surface, it can fall over and injure you or other people. Always place the appliance on an even, load-bearing and non-slip surface.

#### ⚠ CAUTION



The surfaces of the appliance can overheat during operation and overheat heat-sensitive surfaces in close proximity to the appliance. Always place the appliance on a heat-resistant surface and maintain the specified clearance around the appliance.

The distance between the wall and the rear of the appliance must be at least 15 cm. The clearance from the ceiling must not be less than 75 cm and the side clearance from walls or nearby appliances must not be less than 10 cm. Sufficient air circulation in the vicinity of the appliance must be guaranteed at all times.

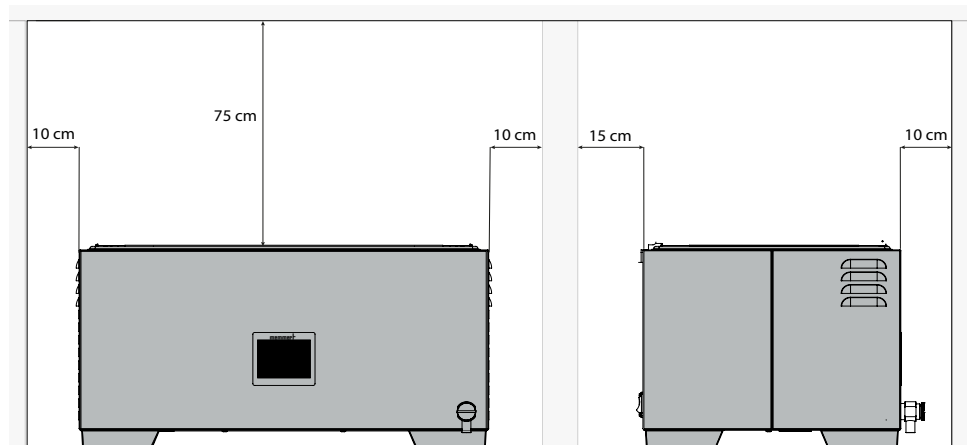

### 3.5 Lid assembly (accessories)

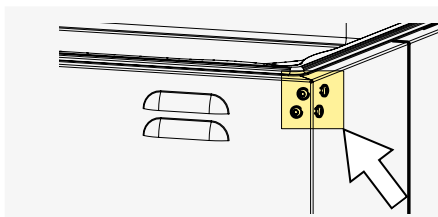

1. Loosen the screws on the fixing points (left and right) for the lid on the water bath.

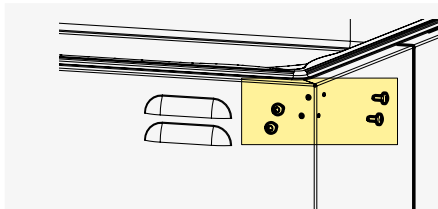

2. Remove screws and set aside.

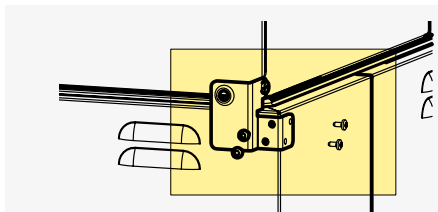

3. Attach the mounting bracket to the lid and fix in place with the screws.

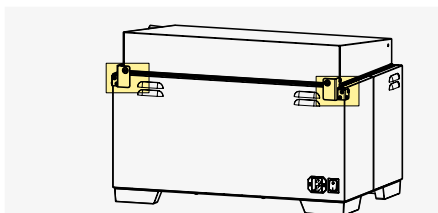

4. Tighten screws and check that the lid fits tightly.

## 4. Putting into operation

### 4.1 Putting into operation for the first time

#### NOTICE

When putting the appliance into operation for the first time, do not leave it unattended until it has reached a steady state.

For connection, please observe the national regulations. Observe the connection and power ratings (see name plate and technical data). Make sure to establish a safe PE conductor connection.

### 4.2 Connect the appliance to the power supply

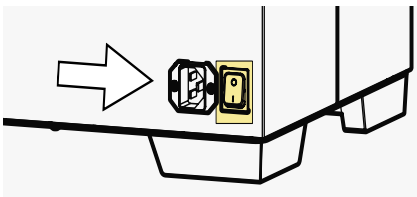

Place the power cable so that

- it does not represent a trip hazard
- it cannot come into contact with any hot parts
- it is easily accessible at all times and can be pulled off quickly, for example in case of interference or an emergency

### 4.3 Filling

#### NOTICE

Observe the following points before filling the water bath:

- Water bath may not be operated while empty
- Check that the outlet valve is closed before filling
- Observe the minimum fill level for the water bath
- Observe the maximum filling level when filling and loading the water bath, which is marked by the edge in the water bath tray

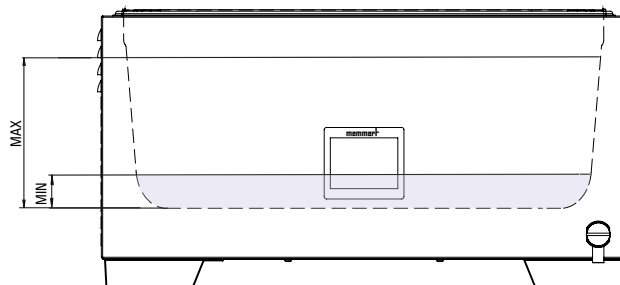

Large WTB	Filling level
6	min. 4 cm
11	
15	
24	min. 2 cm
35	
50	



## 4.4 Water specifications

### NOTICE

Only demineralised water with the following specifications may be used in Memmert appliances:

- Conductivity of 5 – 10  $\mu\text{S}/\text{cm}$
- pH value between 5 and 7

The tray may suffer damage if ultrapure water or DI water with an electrical conductance level of below 5 microsiemens is used.

## 4.5 Switching on appliance

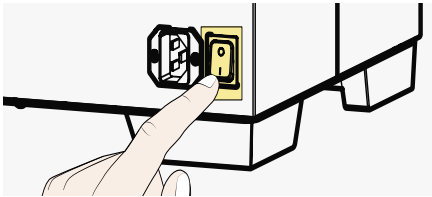

Press main switch on the back of the appliance.

## 5. Operation and control

### 5.1 Home screen

CustomView will appear first after switching the appliance on (5.3.3)

To access the home screen, touch any spot on the TouchDisplay

- ▶ Select the set display **Set** to adjust the set temperature
- ▶ Select the symbol to set the timer
- ▶ Select the symbol to set the alarm temperature
- ▶ Touch the symbol for other appliance settings.

### 5.2 Setting the temperature and time

Set the individual values by scrolling vertically on the touch display:

- ▶ Enter the temperature for the set value in °C/ °F
- ▶ Enter the alarm temperature in °C/ °F
- ▶ Set time for the timer in minutes/hours

Press to confirm entry. The setting is not saved with

### 5.3 Settings

Other settings are possible under the Settings menu item :

- ▶ Set the desired temperature unit as °C or °F
- ▶ Set 2-point calibration
- ▶ Appliance information overview
- ▶ CustomView setting

Press to return to the home screen

### 5.3.1 Temperature display unit

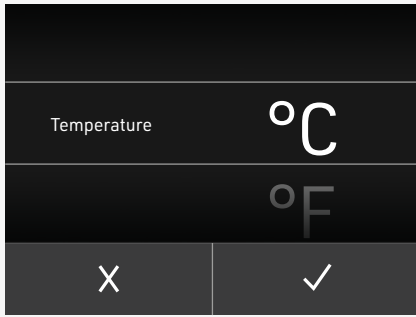

Set the temperature unit in the sub-menu on °C / °F

Set the values by scrolling vertically on the touch display:

### 5.3.2 Calibration settings



Make 2-point calibration in the sub-menu on CAL

- ▶ The left side shows the compensation temperature setting (CAL1 temp / CAL2 temp)
- ▶ The right side shows the compensation correction values (DEV1 / DEV2)

Equipment calibration see chapter 5.5

Press to return to appliance settings

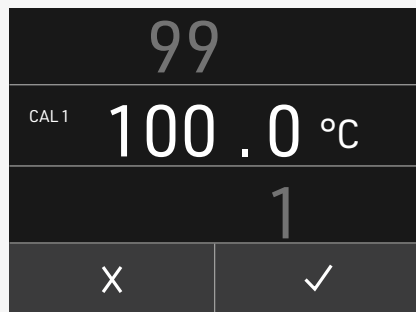

The compensation temperature and compensation correction values are adjusted the same way as the temperature setting, see chapter 5.2

### 5.3.3 CustomView

	<p>Under the Settings menu item, select <b>CustomView</b> to set up the individual display</p>
	<p>Selecting the set temperature, timer time or alarm temperature will activate or deactivate the respective element</p>
	<p>Touching the set temperature, timer time or alarm temperature will activate or deactivate the respective element</p>
	<p>Set temperature, timer time or alarm temperature are deactivated here</p>
	<p>✓ confirms the selection; X changes will not be accepted</p>
	<p>If the selection has been confirmed with ✓, touch  to return to the home screen, the personalised CustomView will appear after 30 seconds</p>

### 5.3.4 Information

	<p>Go to <b>Info</b> under the Settings menu item to view article information for the water bath</p>
--	--

## 5.4 Outlet valve

### ⚠ WARNING



The drain valve can become overheated while emptying the water bath. Touching its surface can cause burns. Use heat-resistant protective gloves to turn the drain valve on/off or let the tempering medium cool down first and empty the water bath when it has reached a lukewarm temperature.

### NOTICE

Observe the following points before emptying the water bath:

- Allow tempering medium to cool down before draining
- Outlet valve can overheat during operation, please observe safety instructions
- Open outlet valve slowly to prevent water from leaking out uncontrolled

When emptying the water bath, let the tempering medium drain either directly into a suitable and adequately sized container or push a suitable tube onto the outlet valve (outlet valve diameter: 12 mm), which hooks into a container.

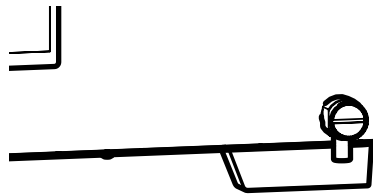

## 5.5 Calibration

The appliances are temperature calibrated and adjusted at the factory. In case readjustment should be necessary later on – for example due to influence of the chamber load – the appliance can be calibrated customer-specifically using three calibration temperatures of your choice:

- Cal1 Temperature calibration at low temperature
- Cal2 Temperature comparison at high temperature

To guarantee perfect control, we recommend calibrating the appliance once a year.

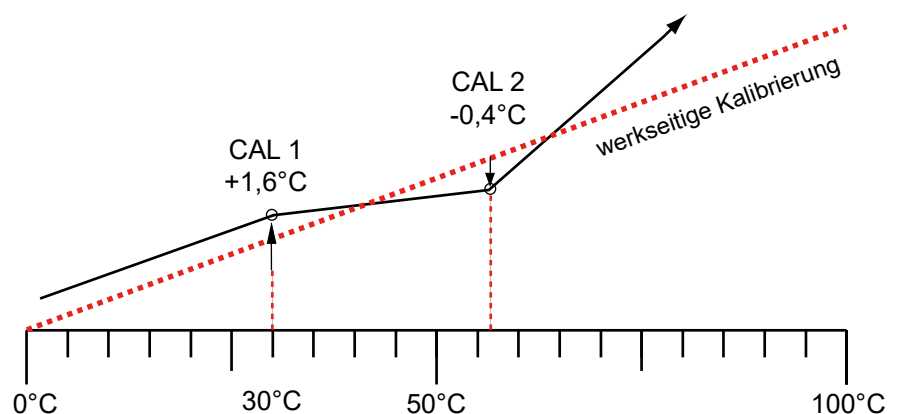

In the following example, the temperature calibration is performed for the example temperature of 30°C:

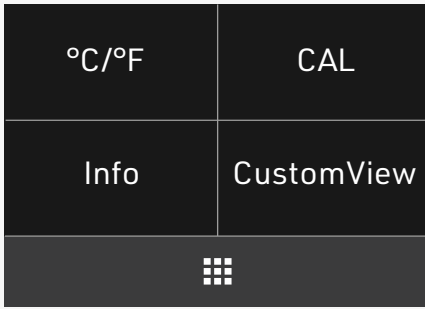

Make 2-point calibration under Appliance Settings on CAL

Press to return to the home screen



Select CAL1Temp to set the compensation temperature CAL1



Scroll vertically to set the compensation temperature CAL1 to 30°C

Press to confirm your selection

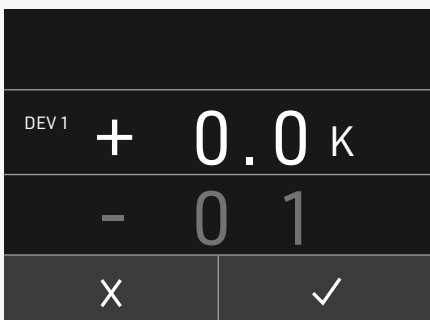

Scroll vertically to set the compensation correction value to 0.0 K

Press to confirm your selection

Press to return to appliance settings

Press to return to the home screen

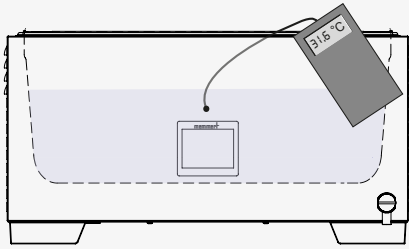

Position the sensor of a calibrated reference instrument centrally in the appliance's working chamber

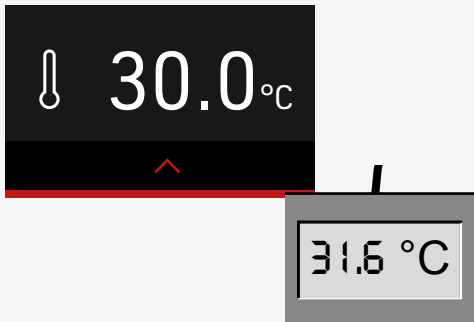

Wait until the appliance reaches the set temperature and displays 30 °C. The reference instrument displays for example 31.6 °C

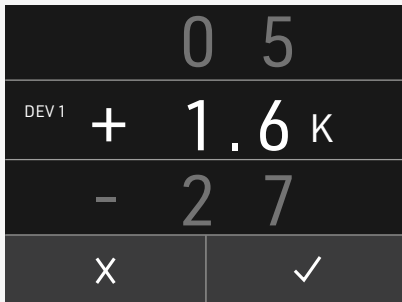





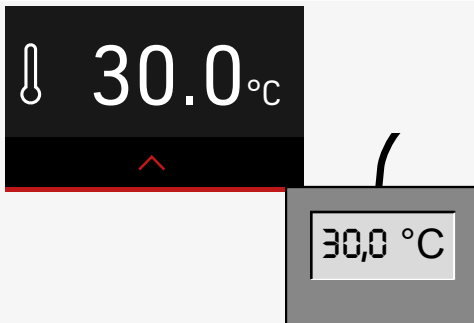

Set compensation correction value for Cal1 to +1.6K (measured actual value minus setpoint)

Press ✓ to confirm your selection



After the calibration procedure, the temperature measured by the reference instrument will now also be 30 °C.

## 6. Malfunctions, warning and error messages

Description	Cause	Action
	Actual temperature has exceeded the set alarm temperature	<ul style="list-style-type: none"> <li>Appliance must cool down until the actual temperature falls below the set alarm temperature</li> <li>Increase alarm temperature if necessary</li> </ul>
	The PTC was triggered. Appliance is too hot, the water level in the appliance may have been too low during operation	<ul style="list-style-type: none"> <li>Switch off appliance</li> <li>Allow to cool down</li> <li>Monitor water level</li> <li>Restart appliance</li> <li>Contact Service if this occurs frequently</li> </ul>
	Temperature sensor error	<ul style="list-style-type: none"> <li>Restart appliance</li> <li>Contact Service if this occurs frequently</li> </ul>
	Software error	<ul style="list-style-type: none"> <li>Restart appliance</li> <li>Contact Service if this occurs frequently</li> </ul>
	Memory access error	<ul style="list-style-type: none"> <li>Restart appliance</li> <li>Contact Service if this occurs frequently</li> </ul>
	CRC error (internal memory error)	<ul style="list-style-type: none"> <li>Restart appliance</li> <li>Contact Service if this occurs frequently</li> </ul>



## 7. Maintenance and Servicing

### **⚠ WARNING**



**Danger due to electric shock.  
Disconnect the mains plug before any cleaning or maintenance work.**

### **⚠ CAUTION**



**Danger of cuts due to sharp edges.  
Always wear gloves when working on the appliance.**

### 7.1 Cleaning

#### 7.1.1 Interior and metal surfaces

Regular cleaning of the easy-to-clean bath prevents build up of material residues that could impair the appearance and functionality of the stainless steel chamber over time.

The metal surfaces of the water bath can be cleaned with normal stainless steel cleaning agents. Make sure that no rusty objects come into contact with the interior or with the stainless steel housing. Rust deposits can lead to an infection of the stainless steel. If rust spots should appear on the surface of the interior due to impurities, the affected area must be immediately cleaned and polished.

#### 7.1.2 Plastic parts

Do not clean plastic parts of the water bath with caustic or solvent-based cleaning agents.

#### 7.1.3 Glass surfaces

Glass surfaces can be cleaned with a commercially available glass cleaner.

### 7.2 Regular maintenance

To guarantee perfect control, we recommend calibrating the appliance once a year

### 7.3 Repairs and service

**⚠ WARNING**



**Live components may be exposed once the covers have been removed. Touching these can lead to an electric shock. Disconnect the mains plug before removing any covers. Work on the electrical system must only be performed by qualified electricians.**



**Repairs and service work are described in a separate service manual.**

## 8. Storage and disposal

---

### 8.1 Storage

The appliance may only be stored under the following conditions:

- in a dry and enclosed, dust-free room
- frost-free
- disconnected from the power supply

Empty water bath before storing.

### 8.2 Disposal

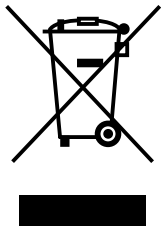

This product is subject to Directive 2012/19/EC on Waste Electrical and Electronic Equipment (WEEE) of the European Parliament and of the Council of Ministers. This appliance was placed on the market after 13 August 2005 in countries which have already integrated this Directive into their national laws. It may not be disposed of in normal household waste. For disposal, please contact your dealer or the manufacturer. Any appliances that are infected, infectious or contaminated with materials hazardous to health are excluded from return. Please also observe all other regulations applicable in this context.

WTB water bath

Operating manual  
D49018 Last updated  
01/2021  
English