

memmert

ICO



OPERATING MANUAL

CO₂ INCUBATOR ICO

MADE IN GERMANY.

www.memmert.com

Manufacturer and customer service

MEMMERT GmbH + Co. KG
Willi-Memmert-Straße 90-96
91186 Büchenbach
Germany

Phone: +49 (0)9122 925-0
Fax: +49 (0)9122 14585
E-mail: sales@memmert.com
Internet: www.memmert.com

Customer service:

Service hotline: +49 (0)9171 9792 911
Service fax: +49 (0)9171 9792 979
E-mail: service@memmert.com

For service enquiries, please always specify the appliance number on the nameplate (see page 12).

Shipping address for repairs:

Memmert GmbH + Co. KG
Customer service
Willi-Memmert-Str. 90-96
DE-91186 Büchenbach
Germany

Please contact our customer service before sending appliances for repair or before returning equipment, otherwise, we have to refuse acceptance of the shipment.

About this manual

Purpose and target audience

This manual describes the design, function, transport, putting into operation, the actual operation and maintenance of CO₂ incubators ICO. It is intended for use by trained personnel of the owner, who have the task of operating and/or maintaining the respective appliance.

If you are asked to work on the appliance, read this manual carefully before starting. Familiarise yourself with the safety regulations. Only perform work that is described in this manual. If there is something you do not understand, or certain information is missing, ask your manager or contact the manufacturer. Do not do anything without authorisation.

Versions

The appliances are available in different configurations and sizes. If specific equipment features or functions are available only for certain configurations, this is indicated at the relevant points in this manual.

The functions described in this manual refer to the latest firmware version.

Due to individual configurations and sizes, illustrations in this manual may be slightly different from the actual appearance. Function and operation are identical.

Other documents that have to be observed

When operating the appliance with the MEMMERT AtmoCONTROL PC software, observe the separate software manual. To open the AtmoCONTROL software manual, click on "Help" in the AtmoCONTROL menu bar.

Storage and resale

This instruction manual belongs with the appliance and should always be stored where persons working on the appliance have access to it. It is the responsibility of the owner to ensure that persons who are working or will work on the appliance are informed as to the whereabouts of this instruction manual. We recommend that it is always stored in a protected location close to the appliance. Make sure that the instruction manual is not damaged by heat or humidity. If the appliance is resold or transported and then set up again at a different location, the operating instructions must go with it.

For the current version of this operating manual in pdf format, please go to <http://www.memmert.com/en/service/downloads/user-manual/>.

Contents

1. For your safety	6
1.1 Terms and signs used.....	6
1.2 Product safety and dangers	6
1.3 Requirements of the operating personnel	8
1.4 Responsibility of the owner.....	8
1.5 Intended use.....	8
1.6 Changes and conversions.....	9
1.7 Behaviour in case of malfunctions and irregularities	9
1.8 What to do in case of accidents.....	9
1.9 Switching off the appliance in an emergency	9
2. Construction and description	10
2.1 Construction	10
2.2 Description and function.....	10
2.3 Material.....	11
2.4 Electrical equipment.....	11
2.5 Connections and interfaces.....	11
2.6 Designation (nameplate).....	12
2.7 Technical data	13
2.8 Applied directives and standards	14
2.9 Declaration of conformity	14
2.10 Ambient conditions	15
2.11 Scope of delivery	15
2.12 Optional accessories.....	15
3. Delivery, transport and setting up	16
3.1 For your safety.....	16
3.2 Delivery	17
3.3 Transport.....	17
3.4 Unpacking	17
3.5 Storage after delivery	17
3.6 Setting up	18
4. Putting into operation	21
4.1 Connect the appliance to the power supply.....	21
4.2 Establishing water supply.....	21
4.3 CO ₂ and N ₂ connection.....	22
4.4 Switching on.....	23
5. Operation and control	24
5.1 For your safety.....	24
5.2 Operating personnel.....	24
5.3 Opening the door.....	25
5.4 Loading the appliance	26
5.5 Operating the appliance.....	26
5.6 Monitoring function.....	33
5.7 Graph.....	40
5.8 Sterilising the appliance	41
5.9 Ending operation.....	42

6.	Malfunctions, warning and error messages	43
6.1	Warning messages of the monitoring function.....	43
6.2	Malfunctions, operating problems and appliance errors	46
6.3	Power failure.....	47
7.	Menu mode	48
7.1	Overview.....	48
7.2	Basic operation in menu mode using the example of language selection.....	49
7.3	Setup.....	50
7.4	Date and time.....	53
7.5	Calibration	54
7.6	Programme.....	60
7.7	Sounds.....	61
7.8	Protocol	62
7.9	USER ID.....	63
8.	Maintenance and Servicing	65
8.1	Regular maintenance.....	65
8.2	Cleaning.....	65
8.3	Repairs and Service.....	65
9.	Storage and disposal	66
9.1	Storage	66
9.2	Disposal	66

1. For your safety

1.1 Terms and signs used

In this manual and on the appliance itself, certain common terms and signs are used to warn you of possible dangers or to give you hints that are important in avoiding injury or damage. Observe and follow these notes and regulations to avoid accidents and damage. These terms and signs are explained below.

1.1.1 Terms used

- ⚠ WARNING** Warns about a dangerous situation that might lead to death or serious injuries
- ⚠ CAUTION** Warns about a dangerous situation that might lead to moderate or minor injuries
- NOTICE** Warns about material damage

1.1.2 Signs used

Danger of electrocution	Fire hazard	Gases / vapours	Danger of frost-bite/ cold burns	Warning about gas bottles
Do not tilt	Disconnect the mains plug	Wear gloves	Wear safety boots	Observe information in separate manual
Information on first aid	First aid: Rinse eyes out	Important or useful additional information		

1.2 Product safety and dangers

The appliances described in this manual are technically sophisticated, manufactured using high-quality materials and subject to many hours of testing in the factory. They reflect the state of the art and comply with recognised technical safety regulations. However, there are still risks involved, even when the appliances are used as intended. These are described below.

⚠ WARNING

After removing covers, live parts may be exposed. You may receive an electric shock if you touch these parts. Disconnect the mains plug before removing any covers. Only electrical engineers may work on the electrical equipment of the appliances.

⚠ WARNING

When loading the appliance with an unsuitable load, poisonous or explosive vapours or gases may be produced. This could cause the appliance to explode, and people could be severely injured or poisoned. The appliance may not be loaded with materials / test objects that release toxic or explosive vapours when heated up (see also chapter Intended use on page 8).

⚠ WARNING

Leaving the door open during operation can cause the appliance to overheat or pose a fire hazard. Do not leave the door open during operation.

⚠ WARNING

Gas bottles may burst or explode at high temperatures. Keep the gas bottles away from open flames. Store gas bottles below 50 °C and ensure that the location is always well ventilated. Prevent water from penetrating as well as backflow into the gas bottles. It is essential that you read the safety notes and instructions of the gas supplier.

⚠ WARNING

Condensation might cause a short circuit. After transport or storage at high humidity conditions, the appliance shall be stored unpacked at normal conditions for at least 24 hours. During this period of time the appliance shall not be connected to the power supply.

⚠ CAUTION

Danger of suffocation. CO₂ and N₂ can have a suffocating effect in high concentrations. In normal mode, the appliance emits small amounts of CO₂ and N₂ to its surroundings. You should therefore ensure that the room in which it is installed is properly ventilated. A ventilation rate of 250 m³ / h is required. Always close the stop valve or pressure reducer on the gas bottles if the appliance is not in operation.

⚠ CAUTION

High concentrations of CO₂ can cause cold burns or frostbite. Avoid contact with CO₂ gas to the eyes and skin.

CO₂ and N₂ are not dangerous substances in terms of the German Hazardous Substances Ordinance (GefStoffV). You should nevertheless familiarise yourself with the applicable safety regulations prior to handling such gas bottles.

1.3 Requirements of the operating personnel

The appliance may only be operated and maintained by persons who are of legal age and have been instructed accordingly. Personnel who are to be trained, instructed or who are undergoing general training may only work with the appliance under the continuous supervision of an experienced person.

Repairs may only be performed by qualified electricians. The regulations in the separate service manual must be observed.

1.4 Responsibility of the owner

The owner of the appliance

- ▶ is responsible for the flawless condition of the appliance and for it being operated in accordance with its intended use (see chapter 1.5);
- ▶ is responsible for ensuring that persons who are to operate or service the appliance are qualified to do this, have been instructed accordingly and are familiar with the operating instructions at hand;
- ▶ must know about the applicable guidelines, requirements and operational safety regulations, and train staff accordingly;
- ▶ is responsible for ensuring that unauthorised persons have no access to the appliance;
- ▶ is responsible for ensuring that the maintenance plan is adhered to and that maintenance work is carried out properly (see page 66);
- ▶ has to ensure that the appliance and its surroundings are kept clean and tidy, for example through corresponding instructions and inspections;
- ▶ is responsible for ensuring that personal protective clothing is worn by operating personnel, e.g. work clothes and safety shoes.

1.5 Intended use

CO₂ incubators ICO are intended for incubation of cell cultures or similar.

The appliance is not explosion-proof (does not comply with the German occupational health & safety regulation VBG 24). The appliance may only be loaded with materials and substances which cannot form any toxic or explosive vapours at the set temperature and which cannot explode, burst or ignite.

The appliance may not be used for the drying, evaporation and baking of paints or similar materials, the solvents of which could form an explosive mixture when combined with air. If there is any doubt as to the composition of materials, they must not be loaded into the appliance. Potentially explosive gas-air mixtures must not form, neither in the working chamber nor in the direct vicinity of the appliance.

Only feed distilled water as well as CO₂ and N₂ into the chamber through the media connections on the rear of the appliance. Introducing other liquids or gases is not permitted.

The incubator may not be used for sterilisation purposes. It is not a steriliser according to the German Law on Medical Products. Sterilisation programmes (see page 61) that are saved in the appliance only serve to sterilise the appliance itself. Do not use them to sterilise medical devices!

1.6 Changes and conversions

No unauthorised changes or alterations may be made to the appliance. No parts may be added or inserted which have not been approved by the manufacturer.

Unauthorised changes or alterations result in the CE declaration of conformity losing its validity, and the appliance may no longer be operated.

The manufacturer is not liable for any damage, danger or injuries that result from unauthorised changes or alterations, or from non-observance of the regulations in this manual.

1.7 Behaviour in case of malfunctions and irregularities

The appliance may only be used in a flawless condition. If you as the operator notice irregularities, malfunctions or damage, immediately take the appliance out of service and inform your superior.

i You can find information on eliminating malfunctions from page 44.

1.8 What to do in case of accidents



1. Keep calm. Act with determination and consideration. Pay attention to your own safety.
2. Switch off the appliance and close the valves of the gas bottle.
3. Call a doctor.
4. Start first aid measures. If available: Call a trained first aid helper.

In case of contact with CO₂ to the eyes and skin:



Rinse eyes out with water for at least 15 minutes. In case of cold burns, rinse with water for at least 15 minutes. Cover over in a sterile way. Call a doctor.

When breathing in CO₂ or N₂:

High concentrations can cause suffocation. Symptoms may include a loss of mobility and unconsciousness. The victim is not aware of suffocating.

Low concentrations of CO₂ can cause accelerated breathing and headaches.

Anyone affected should breathe fresh air, using a breathing device independent of recirculating air. Keep the person warm and calm. Call a doctor. In case of respiratory arrest, use artificial respiration.

In case of gas leakage:

Leave the room immediately, warn others and ventilate the room. If you re-enter the room, use a breathing device independent of recirculating air if it has not been established that the atmosphere is harmless.

1.9 Switching off the appliance in an emergency

Press the main switch at the ControlCOCKPIT (Fig. 1) and disconnect the power plug. This disconnects the appliance from the power supply at all poles.

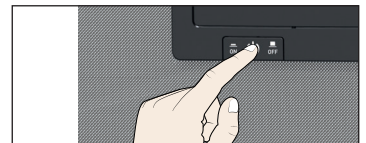

Fig. 1
Switch off the appliance by pressing the main switch

2. Construction and description

2.1 Construction



Fig. 2 Construction of CO₂ incubators ICO

- | | |
|---|---|
| 1 ControlCOCKPIT with capacitive function keys and LCD displays (see page 27) | 4 Stainless steel perforated sheet |
| 2 On/Off switch (see page 23) | 5 Water tray (passive humidity control) |
| 3 Inner glass door | 6 Adjustable feet |
| | 7 Nameplate (see page 12) |

2.2 Description and function

Air is heated inside the appliance by means of large-area all-round heating.

The interior of appliances with passive humidity control is humidified with water that evaporates from a tray that is placed inside. The interior of appliances with active humidity control is humidified with water evaporating at a set rate from a tank by means of a hot-air generator on the rear side of the appliance. The sterile hot air is introduced into the interior above the fan and mixed with the air current. In appliances with water trays, a Peltier humidity trap in the back of the appliance limits humidity. Appliances with active humidity are dehumidified with a dosed supply of fresh air provided through a sterile filter.

Carbon dioxide (CO₂) and nitrogen (N₂ only for models with O₂ module) are also injected into the interior through sterile filters. Interior ventilation ensures a uniform distribution of the gases, creating a homogeneous atmosphere. The oxygen concentration is controlled by introducing nitrogen: If nitrogen is introduced, the concentration of oxygen decreases.

2.3 Material

For the outer housing, MEMMERT uses stainless steel (Mat.No. 1.4016 – ASTM 430) and for the interior, stainless steel (Mat.No. 1.4301 – ASTM 304) is used, which stands out through its high stability, optimal hygienic properties and corrosion resistance to many (but not all!) chemical compounds (caution for example with chlorine compounds).

The chamber load for the appliance must be carefully checked for chemical compatibility with the materials mentioned. A material resistance table can be requested from the manufacturer.

2.4 Electrical equipment

- ▶ Operating voltage and current consumption: See nameplate
- ▶ Protection class I, i.e. operating insulation with PE conductor in accordance with EN 61010
- ▶ Protection type IP 20 acc. to EN 60 529
- ▶ Interference suppression acc. to EN 55011 class B
- ▶ Appliance fuse: Safety fuse 250 V/15 A, quick-blow
- ▶ The temperature controller is protected with a miniature fuse 100 mA (160 mA at 115 V)

2.5 Connections and interfaces

2.5.1 Electrical connection

This appliance is intended for operation on an electrical power system with a system impedance Z_{max} of a maximum of 0.292 ohm at the point of transfer (service line). The operator must ensure that the appliance is operated only on an electrical power system that meets these requirements. If necessary, you can ask your local energy supply company what the system impedance is.

Observe the country-specific regulations when making connections (e.g. in Germany DIN VDE 0100 with earth leakage circuit breaker).

2.5.2 Communication interfaces

The communication interfaces are intended for appliances which meet the requirements of IEC 60950-1.

USB interface

The appliance is fitted by default with a USB interface in accordance with the USB specification. This way, you can

- ▶ transfer software stored on a USB storage medium to the appliance (see page 61).
- ▶ export protocol logs from the appliance to a USB storage medium (see page 63).
- ▶ transfer user ID data stored on a USB storage medium to the appliance (see page 64).

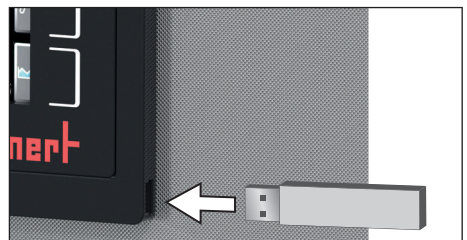

Fig. 3 USB interface

The USB port is located on the right side of the ControlCOCKPIT (Fig. 3).

Ethernet interface

Via Ethernet interface, the appliance can be connected to a network, so that you can transfer programmes created with the AtmoCONTROL software to the appliance and read out protocols. The Ethernet interface is located on the rear of the appliance (Fig. 4).

For identification purposes, each appliance connected must have its own unique IP address. Setting the IP address is described on page 51.

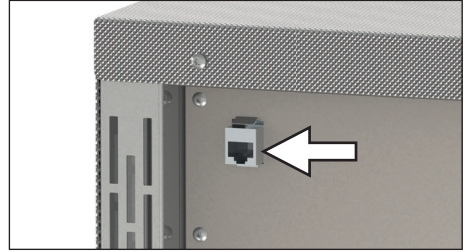

Fig. 4 Ethernet interface



You will find a description of how to transfer programmes via Ethernet in the enclosed AtmoCONTROL manual.

With an optional USB to Ethernet converter, the appliance can be directly connected to a computer / laptop (see Optional accessories on page 15).

2.6 Designation (nameplate)

The nameplate (Fig. 5) provides information about the appliance model, manufacturer and technical data. It is attached on the upper right behind the door (see page 10).

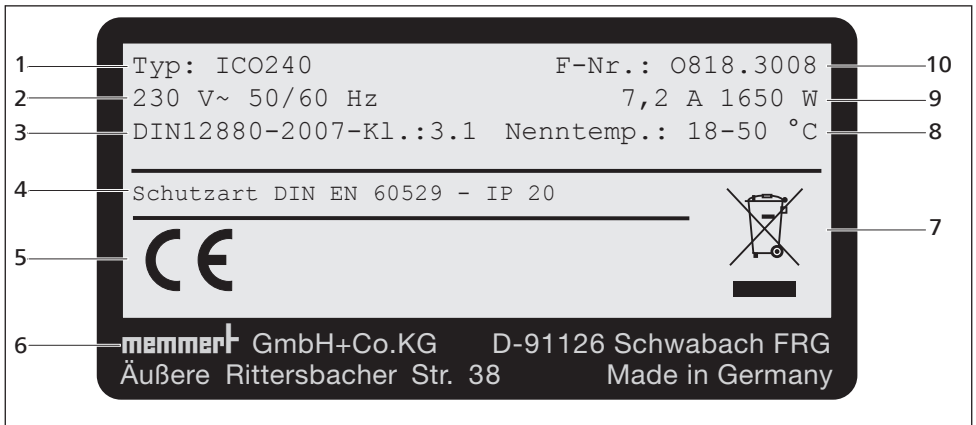

Fig. 5 Nameplate (example)

- | | |
|-----------------------|------------------------------|
| 1 Type designation | 6 Address of manufacturer |
| 2 Operating voltage | 7 Disposal note |
| 3 Applicable standard | 8 Temperature range |
| 4 Protection type | 9 Connection / power ratings |
| 5 CE conformity | 10 Appliance number |

2.7 Technical data

Appliance size	50	105	150	240
Appliance width D* [mm]	559	719	719	759
Appliance height E* [mm] (varies due to adjustable feet)	791	846	1066	1176
Appliance depth F* (without door handle) [mm]	521	591	591	691
Depth of door handle [mm]	56			
Chamber width A* [mm]	400	560	560	600
Chamber height B* [mm]	425	480	700	810
Interior depth C* [mm] (less 35 mm for fan)	330	400	400	500
Chamber volume [litres]	56	107	156	241
Net weight [kg]	55	75	90	110
Weight including packaging [kg]	74	100	116	145
Power [W]	1100	1300	1500	1650
Current consumption [A]	115 V, 50/60 Hz	9,6	11,4	13,1
	230 V, 50/60 Hz	4,8	5,7	6,6
max. number of sliding shelves	5	6	10	12
max. load per sliding shelf [kg]	15			
max. load per appliance [kg]	75	90	120	140
Operating temperature range	5 °C above room temperature up to 50 °C			
Setting temperature range [°C]	+18 to +50			
Adjustment precision [°C]	0.1			
Temporal temperature deviation (in accordance with DIN 12880:2007-05) at 37 °C [K]	±0.1			
Spatial temperature deviation at +37 °C (in accordance with DIN 12880:2007-05) at 37 °C [K]	±0.3			
Adjustment range of active humidity control [% rh] (only for appliances with the corresponding configuration)	40 to 97 and rh off			
Setting accuracy humidity [%]	0.5			
Adjustment range for CO ₂ [%]	0 to 20			
Setting accuracy for CO ₂ [%]	0.1			
Adjustment range for O ₂ [%] (optional and only for appliances with active humidity control)	1 to 20			
Setting accuracy for O ₂ [%]	0.1			

* see Fig. 6 on page 14.

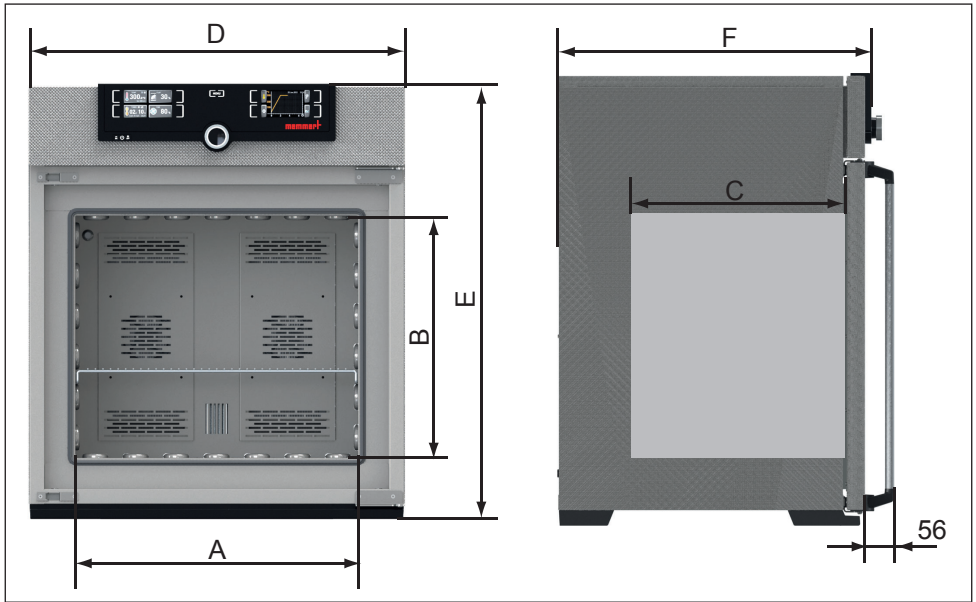

Fig. 6 Dimensions

2.8 Applied directives and standards

Based on the standards and guidelines listed in the following, the products described in this manual have received a CE label from the company Memmert:



- ▶ Directive 2004/108/EC amended (Directive of the council for harmonisation of the laws of the member states on electromagnetic compatibility). Standards complied with: DIN EN 61326:2004-05, EN 61326:1997, EN 61326/A1:1998, EN 61326/A2:2001, EN 61326/A2:2003
- ▶ Directive 2006/95/EC amended (Directive of the council for harmonisation of the laws of member states relating to electrical equipment designed for use within certain voltage limits). Standards complied with: DIN EN 61 010-1 (VDE 0411 part 1), DIN EN 61 010-2-010 (VDE 0411 part 2-010), EN 61 010-1:2001, EN 61 010-2-010

2.9 Declaration of conformity

You can download the EC declaration of conformity of the appliance online:

English: <http://www.memmert.com/en/service/downloads/ce-statement/>

German: <http://www.memmert.com/de/service/downloads/eg-konformitaetserklaerung/>

2.10 Ambient conditions

- ▶ The appliance may only be used in enclosed areas and under the following ambient conditions:

Ambient temperature	10 °C to 35 °C
Humidity rh	max. 70 %, non-condensing
Overvoltage category	II
Pollution degree	2
Altitude of installation	max. 2,000 m above sea level

- ▶ The appliance may not be used in areas where there is a risk of explosion. The ambient air must not contain any explosive dusts, gases, vapours or gas-air mixtures. The appliance is not explosion-proof.
- ▶ Heavy dust production or aggressive vapours in the vicinity of the appliance could lead to sedimentation in the interior and, as a consequence, could result in short circuits or damage to electrical parts. For this reason, sufficient measures to prevent large clouds of dust or aggressive vapours from developing should be taken.

2.11 Scope of delivery

- ▶ Power cable
- ▶ 1 or 2 stainless steel perforated sheets (load capacity: 15 kg each)
- ▶ 1 stainless steel water tray (only for appliances with passive humidity control)
- ▶ 1 water tank (only for appliances with active humidity control)
- ▶ Gas connection hose (depending on the model: one to three)
- ▶ 1 Silicone plugs interior (white)
- ▶ 1 Silicone plugs on the back of the unit (green)
- ▶ USB storage medium with software and AtmoCONTROL manual
- ▶ the operating instructions at hand
- ▶ Calibration certificates
- ▶ Separately packaged fastening material for wall mounting (see page 19)

2.12 Optional accessories

- ▶ USB to Ethernet converter (Fig. 7). Makes it possible to connect the Ethernet connection interface (see page 12) to the USB port of a computer / laptop.

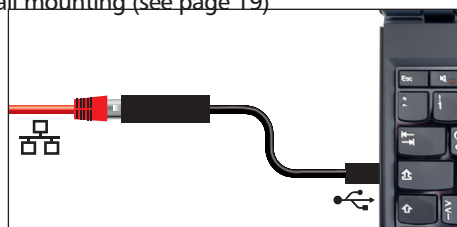

Fig. 7 USB to Ethernet converter

3. Delivery, transport and setting up

3.1 For your safety

⚠ WARNING



Because of the heavy weight of the appliance, you could injure yourself if you try to lift it. To carry appliances of size 50, at least two persons are needed; for appliances of the sizes 105 and 150, four people are needed. Appliances larger than that may not be carried but must be transported with a manual pallet jack or forklift truck.

50	105	150	240

⚠ CAUTION



You might get your hands or feet squashed when transporting and installing the appliance. Wear protective gloves and safety boots. When grasping the bottom of the appliance, grasp it only on the sides:



3.2 Delivery

The appliance is packed in cardboard and is delivered on a wooden palette.

3.3 Transport

The appliance can be transported in the following ways:

- ▶ With a forklift truck; move the forks of the truck entirely under the pallet.
- ▶ On a manual pallet jack

3.4 Unpacking

NOTICE

- ▶ To avoid damage, do not unpack the appliance until you reach the installation site. Remove the cardboard packaging by pulling it upwards or carefully cutting along an edge.

3.4.1 Checking for completeness and transport damage

- ▶ Check the delivery note to ensure that the delivery is complete.
- ▶ Check the appliance for damage.

If you notice deviations from the delivery note, damage or irregularities, do not put the appliance into operation but inform the haulage company and the manufacturer.

3.4.2 Removing the transport protection

Remove the transport protection. It is located between the door hinge, door and frame and has to be removed after opening the door.

3.4.3 Disposing of packaging material

Dispose of the packaging material (cardboard, wood, foil) in accordance with the applicable disposal regulations for the respective material in your country.

3.5 Storage after delivery

If the appliance is first to be stored after delivery: Read the storage conditions from page 67.

3.6 Setting up

3.6.1 Preconditions

The installation site must be flat and horizontal and must be able to reliably bear the weight of the appliance (see Technical data on page 13). Do not place the appliance on a flammable surface.

The appliance emits small amounts of CO₂ and N₂ to its surroundings during operation. Therefore, the installation site must be ventilated.

Depending on the model (see nameplate), a 230 V or 115 V power connection must be available at the installation site.

The distance between the wall and the rear of the appliance must be at least 15 cm. The clearance from the ceiling must not be less than 20 cm and the side clearance from walls or nearby appliances must not be less than 5 cm (Fig. 8). Sufficient air circulation in the vicinity of the appliance must be guaranteed at all times.

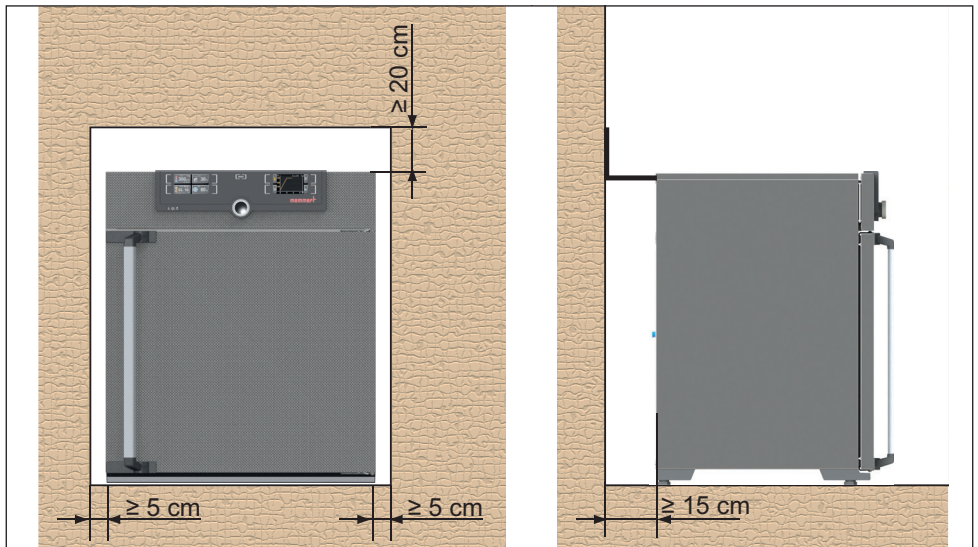
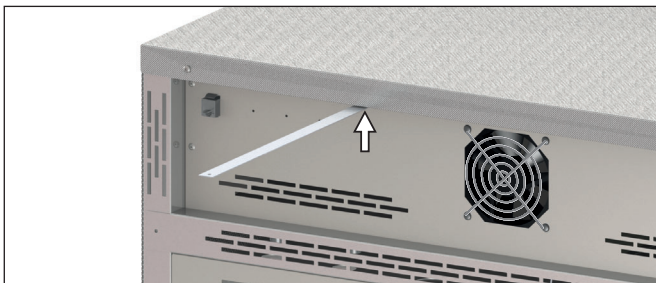

Fig. 8 Minimum clearance from walls and ceiling

3.6.2 Tilt protection

Due to its centre of gravity, the appliance can fall over to the front and injure you or other people. Always attach the appliance to a wall with the tilt protection included in the delivery. In case there is not enough space, do not put the appliance into operation and do not open the door. Contact the Memmert service (see page 2).

1. Screw the tilt protection onto the back of the appliance as illustrated.



2. Bend the tilt protection upwards by 90 ° in the desired distance to the wall (consider the minimum distance to the wall, see Fig. 8).



3. Drill a hole, insert a plug and screw the tilt protection to a suitable wall.

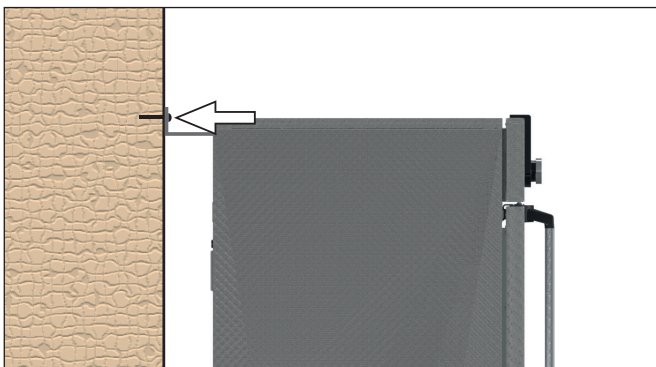

3.6.3 Adjusting the doors

For appliances it is possible to adjust doors that warp due to the floor conditions. In order to do so, every door has two adjuster screws at the top and at the bottom (Fig. 9).

1 First, adjust the door at the top and then, if further adjustment is necessary, at the bottom as well.

1. Open the door.
2. Undo the screws.
3. Adjust the door.
4. Tighten the screws again.
5. Check door alignment.
6. If necessary, readjust.

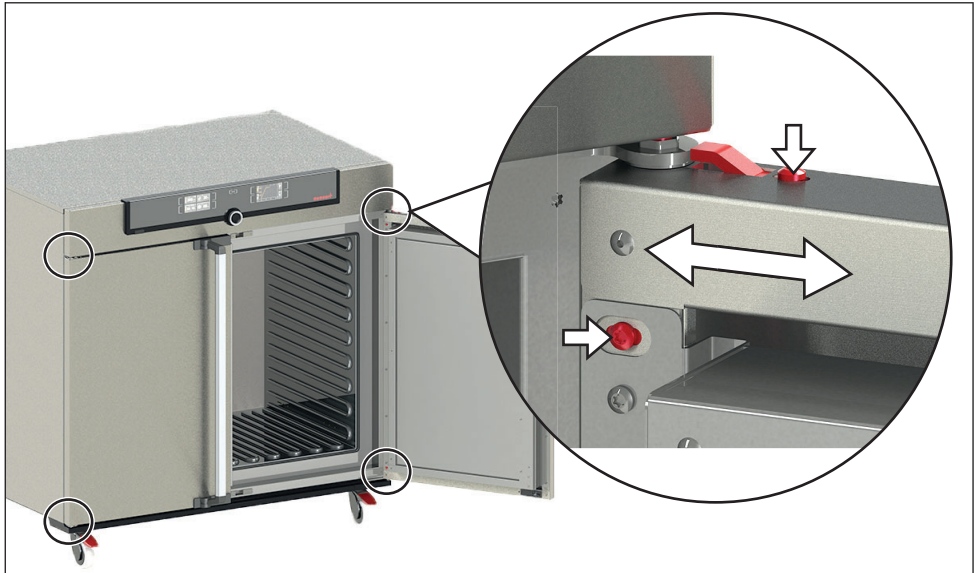

Fig. 9 Door adjustment screws

4. Putting into operation

NOTICE

The first time the appliance is operated, it must not be left unattended until it has reached the steady state.

4.1 Connect the appliance to the power supply

⚠ WARNING



Condensation might cause a short circuit. After transport or storage at high humidity conditions, the appliance shall be stored unpacked at normal conditions for at least 24 hours. During this period of time the appliance shall not be connected to the power supply.

Observe the country-specific regulations when making connections (e.g. in Germany: DIN VDE 0100 with earth leakage circuit breaker). Observe the connection and power ratings (see nameplate and "Technical Data" on page 13). Make sure to establish a safe PE conductor connection.

Plug the provided power cable into the rear of the appliance and connect it to the power supply (Fig. 10). Place the power cable so that

- ▶ it is easily accessible at all times and can be pulled off quickly, for example in case of interference or an emergency;
- ▶ it does not represent a trip hazard;
- ▶ it cannot come into contact with any hot parts.

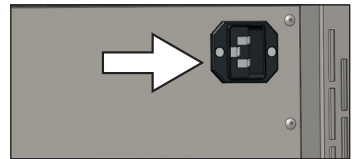

Fig. 10 Connect the power cable to the rear of the appliance

4.2 Establishing water supply

4.2.1 Water specifications

Only demineralised/deionised water with the following specifications may be used in Memmert appliances:

- ▶ Conductivity of 5 – 10 $\mu\text{S}/\text{cm}$
- ▶ pH value between 5 and 7
- ▶ chlorine-free

The use of ultrapure water or DI water with an electrical conductance level below 5 $\mu\text{S}/\text{cm}$ can damage silicone tubing and cause pitting on the stainless steel components installed. Unsuitable water also creates favourable conditions for limescale in the steam generators and steam pipes.

4.2.2 For appliances with passive humidity control: inserting the water tray

Mount the provided sealing lip to the narrow side of the water tray (Fig. 11) and fill 1.5 cm to 2 cm of water into the tray (for specifications see section 4.2.1).

Place the water tray with the attached sealing lip in the centre of the appliance floor and carefully push it towards the rear panel until the sealing lip is completely under the ventilation opening, touching the rear panel along its entire length (Fig. 11). The sealing lip magnetically adheres to the rear panel and returns the water condensing on the humidity limiter to the water tray.

NOTICE

Important: make sure not to spill any water and make sure that no water flows past the water tray and onto the floor, as this would cause the humidity to exceed the maximum values.

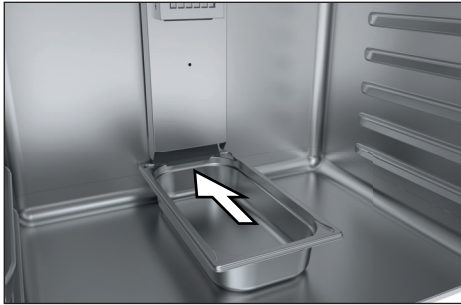

Fig. 11 Push the water tray to the rear panel

4.2.3 For appliances with active humidity control: Fill up and connect the water tank

Fill the supplied water tank with water and use the enclosed tube to connect it to the “H₂O” connection on the rear of the chamber (Fig. 13).

4.3 CO₂ and N₂ connection

⚠ WARNING



Danger of explosion and poisoning when introducing gases/substances other than CO₂ and N₂. Only carbon dioxide (CO₂) and nitrogen (N₂) may be introduced into the appliance through the gas connections on the rear of the appliance.

⚠ WARNING



Gas bottles may burst or explode at high temperatures. Keep the gas bottles away from open flames. Do not store gas bottles at or above 50 °C and ensure that the location is always well-ventilated. Prevent water from penetrating as well as backflow into the gas bottles. It is essential that you read the safety notes and instructions of the gas supplier.

⚠ CAUTION

Danger of suffocation. CO₂ and N₂ can have a suffocating effect in high concentrations. In normal mode, the appliance emits small amounts of CO₂ and N₂ to its surroundings. You should therefore ensure that the room in which it is installed is properly ventilated. A ventilation rate of 250 m³ / h is required. Always close the stop valve or pressure reducer on the gas bottles if the appliance is not in operation.

⚠ CAUTION

High concentrations of CO₂ can cause cold burns or frostbite. Avoid contact with CO₂ gas to the eyes and skin.

CO₂ specification

- ▶ carbon dioxide 4.5
- ▶ purity 99,995 Vol. %

On the rear of the appliance, connect the delivered gas connection tubes to the CO₂ and N₂ gas bottles (pressure reducer) and to the connections "CO₂ In" and "N₂ In" (N₂ only for appliances with active humidity control) (Fig. 13). Set pressure reducer to between 1.0 and 1.2 bar.



Fig. 12 CO₂ connection

4.4 Switching on

Switch on the appliance by pressing the On/Off switch on the front of the appliance (Fig. 13).

Three animated white dots **●●●** indicate that start-up is in progress. If the dots have another colour, an error has occurred (see page 48).

1 After the first start-up, the appliance display is set to English by default. You can change the language as described from page 50. However, to get a basic overview of operating the appliance, you should read the following chapter first.

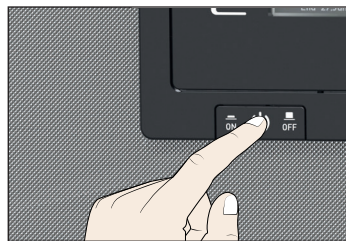

Fig. 13 Switch on appliance

5. Operation and control

5.1 For your safety

WARNING



Leaving the door open during operation can cause the appliance to overheat or pose a fire hazard. Do not leave the door open during operation.

WARNING



Gas bottles may burst or explode at high temperatures. Keep the gas bottles away from open flames. Do not store gas bottles at or above 50 °C and ensure that the location is always well-ventilated. Prevent water from penetrating as well as backflow into the gas bottles. It is essential that you read the safety notes and instructions of the gas supplier.

CAUTION



Danger of suffocation. CO₂ and N₂ in high concentrations can have a suffocating effect. In normal mode, the appliance emits small amounts of CO₂ and N₂ to its surroundings. You should therefore ensure that the room is properly ventilated. A ventilation rate of 250 m³ / h is required. Always close the stop valve or pressure reducer on the gas bottles if the appliance is not in operation.

CAUTION



High concentrations of CO₂ can cause cold burns or frostbite. Avoid contact with CO₂ gas to the eyes and skin.

5.2 Operating personnel

The appliance may only be operated by persons who are of legal age and have been instructed accordingly. Personnel who are to be trained, instructed or who are undergoing general training may only work with the appliance under the continuous supervision of an experienced person.

5.3 Opening the door

- ▶ To open the door, pull the door handle to the side (to the left or to the right, depending on the door variation, see Fig. Fig. 14, A).
- ▶ To close the appliance, push the door closed and push the door handle to the side (B).

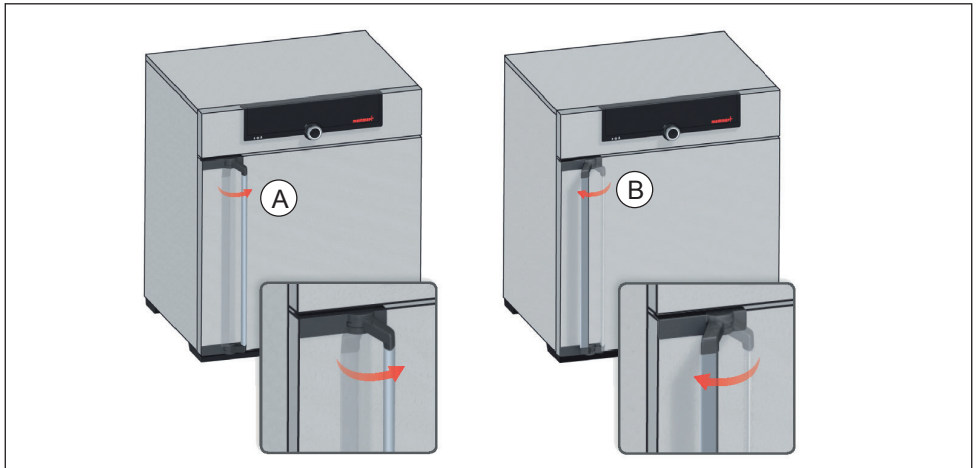

Fig. 14 Opening and closing the door

5.3.1 Appliance behaviour when door is open

- ▶ “Door open” symbol appears on controller
- ▶ Heaters shut off
- ▶ Fan shut off
- ▶ Acoustic alarm after 30 seconds
- ▶ Carbon dioxide and temperature alarms go off as well

5.4 Loading the appliance

⚠ WARNING



When loading the appliance with an unsuitable load, poisonous or explosive vapours or gases may be produced. This could cause the appliance to explode, and people could be severely injured or poisoned. The appliance may only be loaded with materials which do not form any toxic or explosive vapours when heated up and cannot ignite (see also Intended use on page 8). If there is any doubt as to the composition of materials, they must not be loaded into the appliance.

NOTICE

- ▶ Check the chamber load for chemical compatibility with the materials of the appliance (see page 11).

Insert the sliding steel grids or sliding shelves. The maximum number of grids / shelves and the load capacity are specified in the technical data overview from page 13.

Load the chamber leaving enough space between the items so that proper air circulation in the interior is guaranteed. Do not place any of the chamber load on the bottom, touching the side walls or right below the ceiling of the chamber (Fig. 15, see also the "correct loading" sticker on the appliance).

In case of improper loading (not enough space between the items), the set temperature may be exceeded or it may take longer until it is reached.

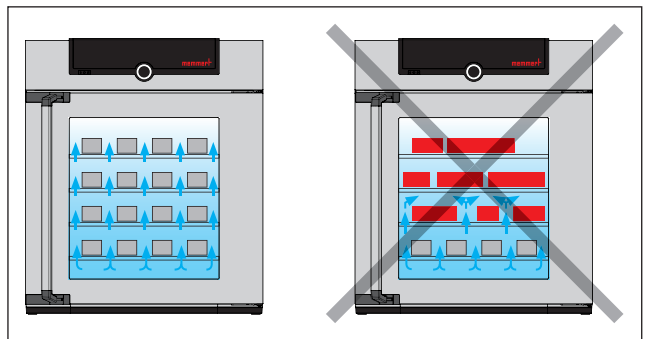

Fig. 15 Correct placement of the chamber load

5.5 Operating the appliance

5.5.1 ControlCOCKPIT

In manual operation, the desired parameters are entered at the ControlCOCKPIT on the front of the appliance (Fig. 16 and Fig. 17). You can also make basic settings here (menu mode). Additionally, warning messages are displayed, e.g. if the temperature is exceeded. In programme mode, the parameters defined, the programme description, the programme segment currently active and programme duration remaining are displayed (for a more detailed description, see page 31).

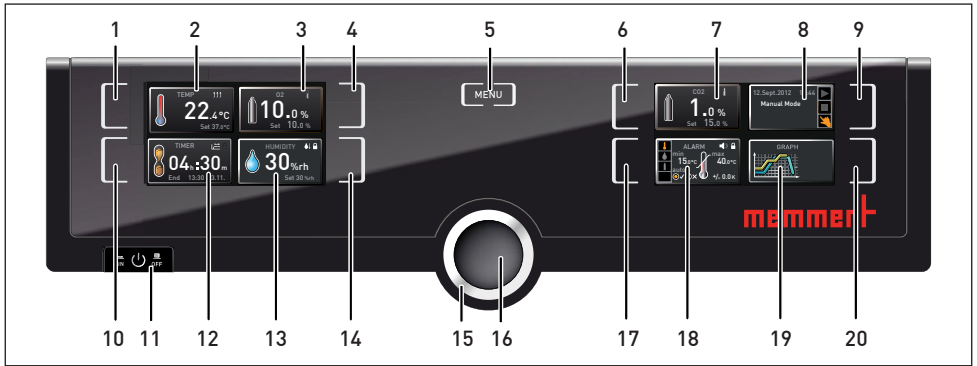

Fig. 16 ControlCOCKPIT of ICO appliances with O₂ and active humidity control in operating mode

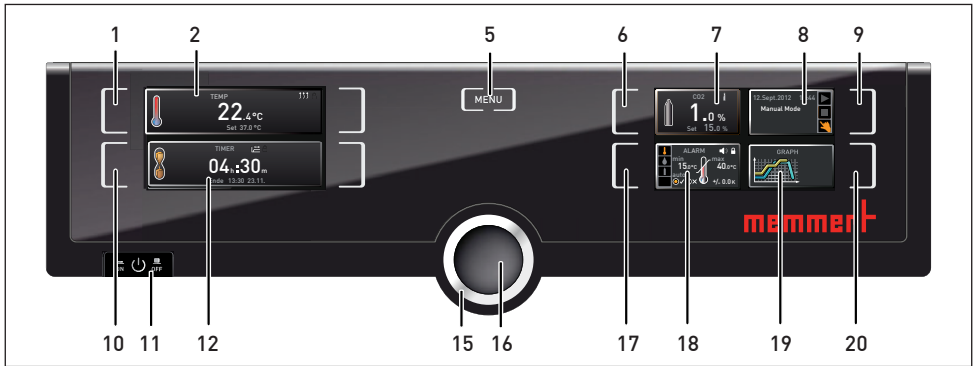

Fig. 17 ControlCOCKPIT of ICO appliances without O₂ and active humidity control in operating mode

- | | |
|--|--|
| <ol style="list-style-type: none"> 1 Activation key for temperature setpoint adjustment 2 Setpoint and actual temperature display 3 Display O₂ setpoint and actual value 4 Activation key for setting the O₂ setpoint 5 Switch to menu mode (see page 49) 6 Activation key for setting the CO₂ setpoint 7 Display CO₂ setpoint and actual value 8 Appliance state and programme display 9 Activation key for the appliance state 10 Activation key digital backwards counter with target time setting, adjustable from 1 minute to 99 days 11 On/Off switch | <ol style="list-style-type: none"> 12 Display digital backwards counter with target time setting, adjustable from 1 minute to 99 days 13 Display humidity setpoint and actual value 14 Humidity control activation key 15 Turn control for setpoint adjustment 16 Confirmation key (accepts setting made with the turn control) 17 Activation key for setting the temperature, humidity, CO₂ and O₂ monitoring 18 Temperature, humidity, CO₂ and O₂ monitoring 19 Graphical representation of setpoint and actual values 20 Activation key for graphic representation |
|--|--|

5.5.2 Basic operation

In general, all settings are made according to the following pattern:

1. Activate the desired parameter (e.g. temperature). To do so, press the corresponding activation key on the left or right or the respective display. The activated display is lined in colour, the other displays are dimmed. The set value is highlighted in colour.

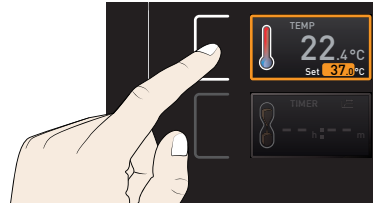

2. By turning the turn control to the left or right, adjust the set value (e.g. to 37.0 °C).

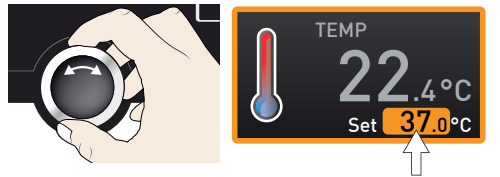

3. Save the set value by pressing the confirmation key. The display returns to normal and the appliance begins adjusting to the defined set value.

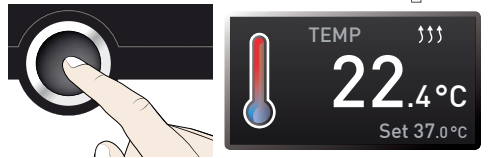

Additional parameters can be set accordingly.

- 1 If no new values are entered or confirmed for approx. 30 seconds, the appliance automatically restores the former values.

If you want to cancel the setting procedure, press the activation key on the left or right of the display that you want to exit. The appliance restores the former values. Only the settings that you have confirmed by pressing the confirmation key before cancelling the setting procedure are accepted.

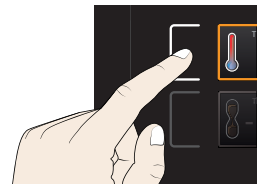



5.5.3 Operating modes

The appliance can be operated in different modes:

- ▶ Manual mode: The appliance runs in permanent operation at the values set on the ControlCOCKPIT. Operation in this mode is described in chapter 5.5.4.
- ▶ Operation with digital backwards counter with target time setting, adjustable from 1 minute to 99 days (timer): The appliance runs at the values set until the timer has elapsed. Operation in this mode is described in chapter 5.5.5.
- ▶ Programme mode: The appliance automatically runs programme sequences which have been defined using AtmoCONTROL software at a computer / laptop and then transferred to the appliance from a USB stick or via Ethernet. Operation in this mode is described in chapter 5.5.6.
- ▶ via remote control (AtmoREMOTE)

i The status display shows you which operating mode or operating state the appliance is currently in. The current operating state is highlighted in colour and indicated by the text display:

-  Appliance is in programme mode
-  Programme is stopped
-  Appliance is in manual mode

The example on the right shows the appliance in manual mode, identified by the coloured hand symbol.

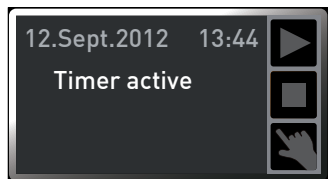
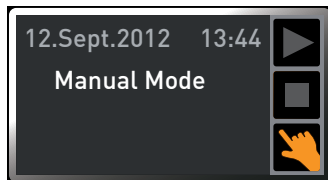

▶ When the appliance is in timer mode, Timer active is displayed:

▶ If the appliance is in remote control mode, the  symbol appears in the temperature display:

5.5.4 Manual mode

In this operating mode, the appliance runs in permanent operation at the values set on the ControlCOCKPIT.

Adjustment options

As described in chapter 5.5.2, you can set the following parameters after pressing the corresponding activation key (in any sequence):

Temperature

Adjustment range: +18 °C to +50 °C

i Heating operation is indicated by the  symbol.

You can select °C or °F as the temperature unit displayed (see page 52).

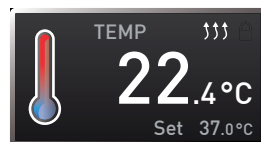
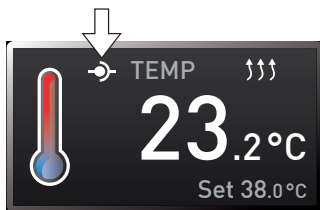

Humidity (only for appliances with active humidity control)

Adjustment range: 40 to 97 % rh and OFF

● Humidification is indicated by the  symbol.

i Dehumidification is indicated by the  symbol.

When the appliance heats up, the humidity is dynamically adjusted to approach the setpoint depending on the dew point of the interior temperature.



CO₂

Adjustment range: 0 to 20 % in steps of 0.1 %

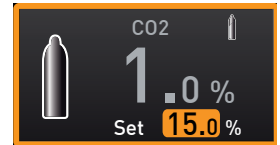

1 The number 1 or 2 displayed in the gas bottle symbol indicates which gas bottle is currently active.



O₂ (only for corresponding model)

Adjustment range: 1 % to 20 % in steps of 0.1 %

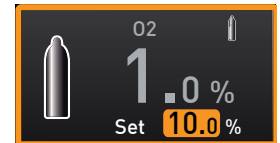

5.5.5 Operation with digital backwards counter with target time setting, adjustable from 1 minute to 99 days (timer)

In timer operation, you can adjust the time the appliance runs at the set values. The appliance has to be in manual operating mode for this.

1. Press the activation key to the left of the timer display. The timer display is activated.

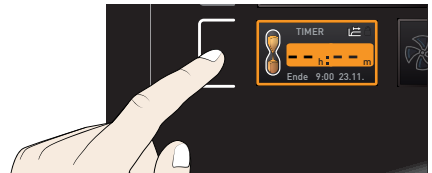

2. Turn the turn control until the desired duration is displayed – in this example 4 hours 30 minutes. The approximate end time is shown beneath, in a smaller font.



1 Up to a duration of 23 hours 59 minutes, the time is displayed in hh:mm (hours:minutes) format. For 24 hours and more, the format dd:hh (days:hours) is used. The maximum duration adjustable is 99 days 00 hours.

3. Press the confirmation key to confirm.

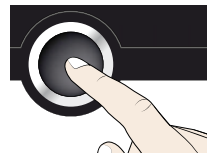

The display now shows the remaining time in a large font and the approximate end time in a smaller font beneath. The status display shows Timer active.



- Now, as described under 5.5.2, set the individual values which you want the appliance to operate at. The set values can be changed at any time while the timer elapses. The changes are effective immediately.
- In Setup, you can choose if the timer should run setpoint-dependent or not. This determines whether the timer should not start until a tolerance band around the set temperature is reached or if it should start right after activation (see page 53). If the timer runs setpoint-dependent, this is indicated by the  symbol in the timer display.

When the timer expires, the display shows 00h:00m. All functions (heating etc.) are switched off. In addition, an acoustic alarm sounds, which can be turned off by pressing the confirmation key.

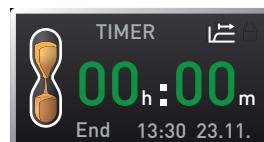

- Note that condensation may occur in the interior after you switch off the heating.

To deactivate the timer, open the timer display by pressing the activation key again and then turning the turn control to reduce the timer setting until --:-- is displayed. Confirm with the confirmation key.

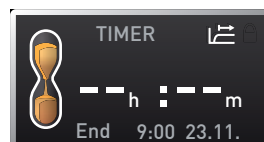

5.5.6 Programme mode

In this operating mode, programmes saved in the appliance can be started with different combinations of individual parameters (temperature, humidity, etc.) at staggered intervals, which the appliance then automatically processes in sequence. These programmes are not created directly at the appliance but externally at a computer / laptop and using AtmoCONTROL software. Transfer to the appliance is possible using the provided USB storage medium or via Ethernet.





A description of how to create and save programmes can be found in the separate AtmoCONTROL software manual.

NOTICE

One or several default sterilisation programmes are saved in the appliance (see page 61). They only serve to sterilise the appliance itself. Do not use them to sterilise medical devices. The hold time in the sterilisation programme set in the appliance at 180 °C is 1 h. The total time including heating up and cooling down to 50 °C is 6 h 30 min.

Starting a programme

- Press the activation key to the right of the status display. The current operating mode is highlighted automatically, in this example Manual mode ().
- Turn the turn control until the  start symbol is highlighted. The current programme is displayed, in this example Steri 180.

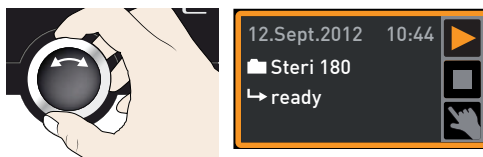

1 Only the programme currently selected in menu mode and shown in the display can be used. If you want to process another programme, you need to activate it in menu mode first (description from page 61).

3. To start the programme, press the confirmation key. The programme is executed. The display shows:

- ▶ the programme description (in this example Steri 180)
- ▶ the programme segment description, in this example Heat up
- ▶ the current run (in case of loops)

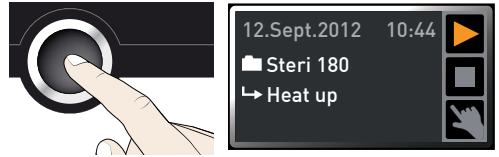



1 You cannot change any parameters (e.g. the temperature) at the appliance while a programme is running. However, the displays ALARM and GRAPH can still be used.

Cancel programme

You can cancel an active programme at any time.

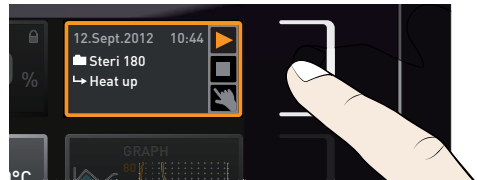
1. Press the activation key to the right of the status display. The status display is automatically highlighted.



2. Turn the turn control until the stop symbol  is highlighted.

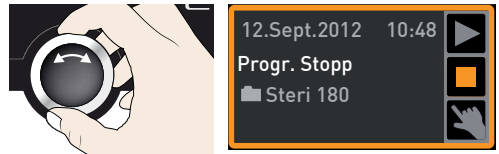

3. Press the confirmation key to confirm. The programme is cancelled.



1 A cancelled programme cannot be resumed at the point it was cancelled. It must be restarted from the beginning.

End of programme

End is shown on the display to indicate that the programme has finished.

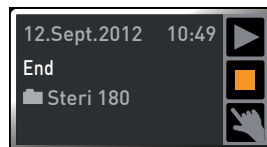

You can now

- ▶ restart the programme as described
- ▶ select another programme for processing in menu mode (see page 61) and run it as described.
- ▶ return to manual mode. To do so, reactivate it by pressing the activation key next to the status display, then turn the turn control until the hand symbol  is highlighted in colour and press the confirmation key.

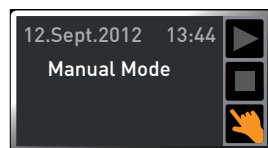

5.6 Monitoring function

5.6.1 Temperature monitoring

The appliance is equipped with a multiple overtemperature protection in accordance with DIN 12 880. This serves to avoid damage to the chamber load and/or appliance in case of a malfunction:

- ▶ electronic temperature monitoring (TWW/TWB)
- ▶ automatic temperature monitor (ASF)
- ▶ mechanical temperature limiter (TB)

The monitoring temperature of the electronic temperature monitor is measured via a separate Pt100 temperature sensor in the interior. Temperature monitoring settings are made via the ALARM display. The settings made apply to all operating modes.

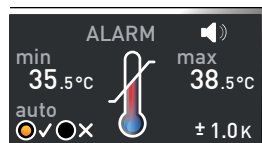

If temperature monitoring has been triggered, this is indicated by the temperature display: the actual temperature is highlighted in red and a warning symbol  is displayed (Fig. 18). The type of temperature monitoring triggered (TWW in this example) is shown beneath the temperature.

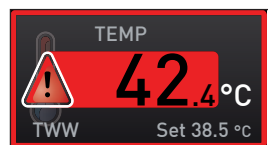



Fig. 18
Temperature monitoring triggered

If the acoustic alarm has been activated in menu mode (Sound see page 62, indicated by the speaker symbol  in the alarm display), the alarm is additionally signalled by an intermittent acoustic signal, which can be turned off by pressing the confirmation key. Information on what to do in this case is provided in chapter Malfunctions, warning and error messages from page 44.

Before reading how to adjust temperature monitoring (from page 35), please read the description of the individual monitoring functions here.

Electronic temperature monitoring (TWW)

The manually set monitoring temperature min and max of the overtemperature control is monitored by an adjustable over/undertemperature controller (TWW) of protection class 3.3 according to DIN 12 880. If the manually set monitoring temperature max is exceeded, the TWW takes overtemperature control and begins to regulate the monitoring temperature (Fig. 19).

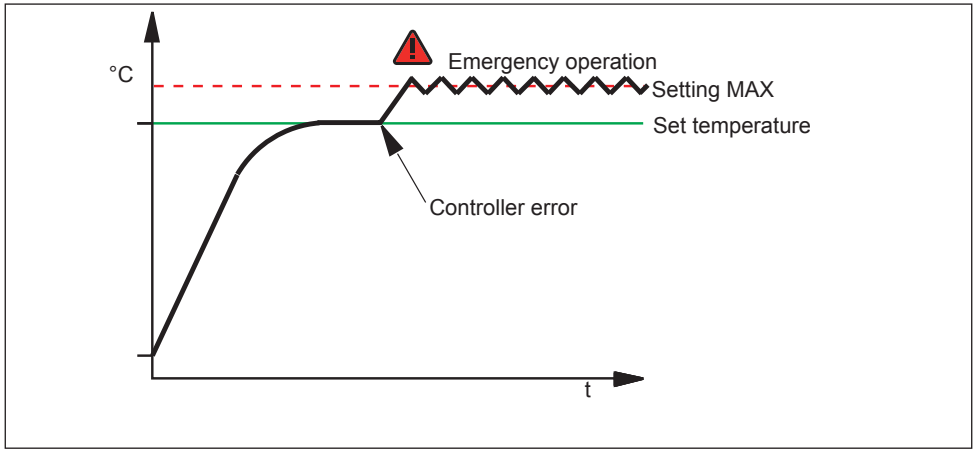

Fig. 19 Schematic diagram of how TWW temperature monitoring works

Electronic temperature limiter (TWB) protection class 2 acc. to DIN 12 880

If the manually set monitoring temperature max is exceeded, the TWB switches off heating permanently (Fig. 20) and can be reset by pressing the confirmation key.

i In programme mode, the current programme is resumed for TWB alarms of up to 15 minutes. If the alarm active for more than 15 minutes, the programme is cancelled.

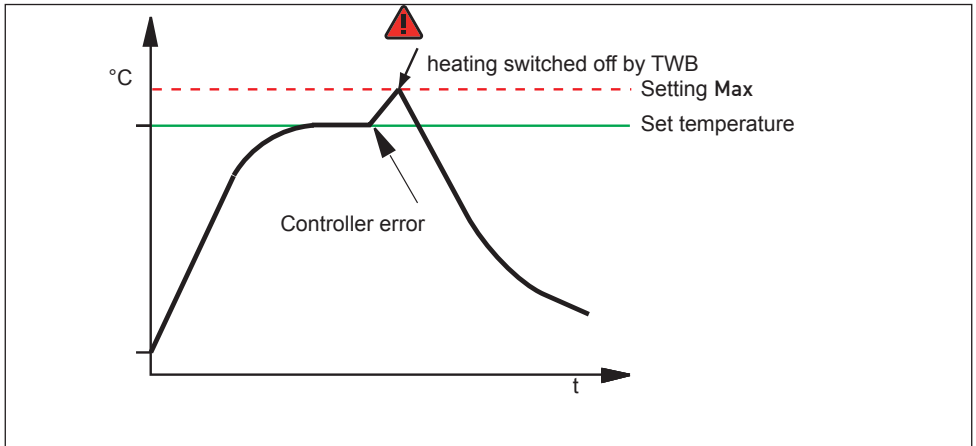

Fig. 20 Schematic diagram of how the TWB temperature monitoring works

Automatic temperature monitor (ASF)

ASF is a monitoring device that automatically follows the set temperature setpoint within an adjustable tolerance band (Fig. 21).

The ASF – if switched on – is automatically activated as soon as the actual temperature value reaches 50 % of the set tolerance band of the setpoint (in the example: $50\text{ °C} \pm 1\text{ K}$) for the first time (section A).

When the temperature violates the set tolerance band around the setpoint (in the example in Fig. 21:

50 °C ± 2 K) – e.g. if the door is opened during operation (section B of illustration) – the alarm is set off. The ASF alarm is automatically triggered as soon as 50 % of the set tolerance band of the setpoint (in the example: 50 °C ± 1 K) are reached again (section C).

If the temperature setpoint is altered, the ASF is automatically disabled temporarily (in this example: The setpoint is changed from 50 °C to 25 °C, section D), until it reaches the tolerance range of the new temperature setpoint (section E).

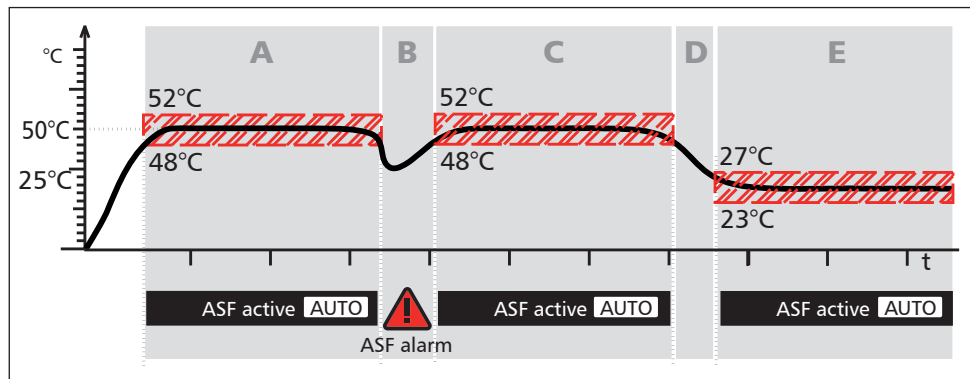
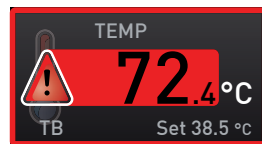

Fig. 21 Schematic diagram of how the ASF temperature monitoring works

Mechanical temperature monitoring: Temperature limiter (TB)

The appliance is equipped with a mechanical temperature limiter (TB) of protection class 1 in accordance with DIN 12 880. If the electronic monitoring unit fails during operation and the default maximum temperature is exceeded by at least 20 °C, the temperature limiter, as the final protective measure, switches off the heating permanently.



Adjusting temperature monitoring

1. Press the activation key to the left of the ALARM display. The temperature monitoring setting is automatically activated (↓).
2. Save the selection by pressing the confirmation key. The min setting (under-temperature protection) is automatically activated.

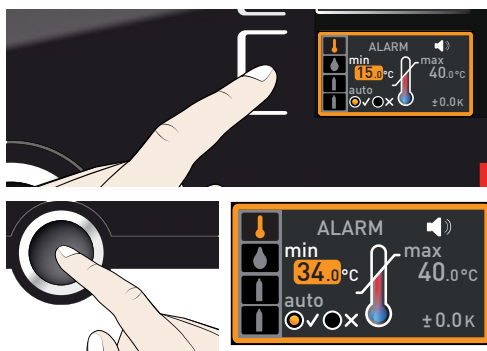

- By turning the turn control, adjust the desired lower alarm limit value, in the example on the right 35.5 °C.

i The lower alarm limit value cannot be set higher than the top one. If no undertemperature protection limit is required, set the lowest temperature.

- Press the confirmation key to confirm. The max display (overtemperature protection) is activated.

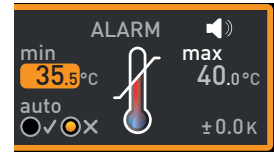

- By turning the turn control, adjust the desired upper alarm limit value, in the example on the right 38.5 °C.

i The monitoring temperature must be set sufficiently high above the maximum set temperature. We recommend 0.5 to 1 K.

- Accept the upper alarm limit value by pressing the confirmation key. The setting of the automatic temperature monitor (ASF) is automatically activated (auto).

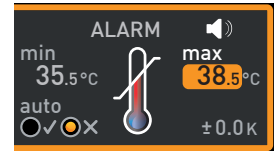
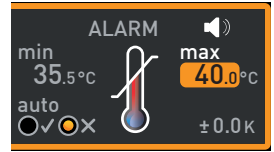
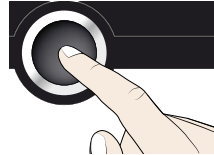

- With the turn control, select ON (✓) or OFF (✗).

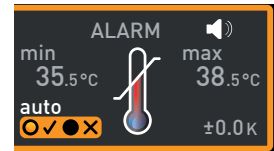
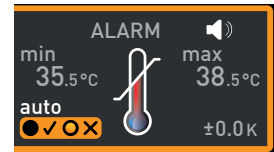
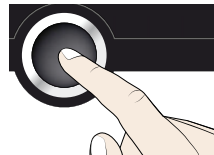

- Press the confirmation key to confirm. The ASF tolerance band setting is activated.

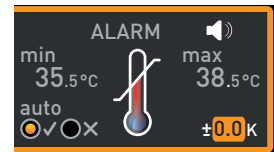
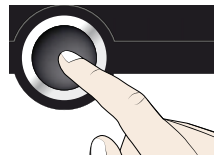

- With the turn control, adjust the desired tolerance band. We recommend 0.5 to 1 K.

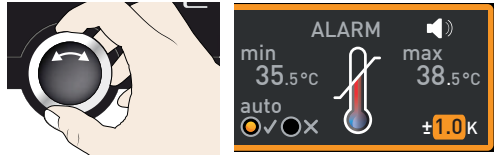

- Press the confirmation key to confirm. Temperature monitoring is now active.

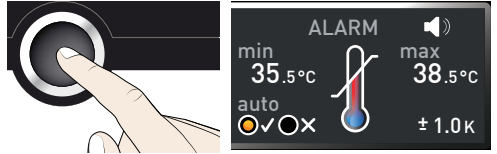

5.6.2 Humidity monitoring

(only for appliances in the corresponding configuration)

If humidity monitoring was triggered, this is indicated by the humidity display: the actual humidity is highlighted in red and a warning symbol ▲ is shown (Fig. 22). If the acoustic alarm has been activated in menu mode (Sound, see page 62, as indicated by the speaker symbol 🔊), the alarm is additionally signalled by an intermittent acoustic signal. Information on what to do in this case is provided in chapter Malfunctions, warning and error messages from page 49.



Fig. 22
Humidity monitoring triggered

Adjusting humidity monitoring (only for appliances in the corresponding configuration)

- Press the activation key to the left of the ALARM display. The temperature monitoring setting is automatically activated.
- Turn the turn control until the humidity monitoring entry 🌧️ is highlighted.

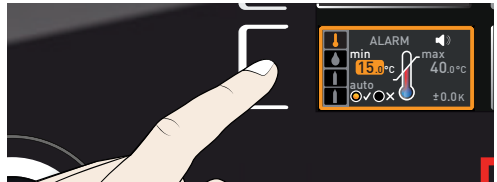

3. Accept the selection by pressing the confirmation key. The lower humidity alarm limit is automatically highlighted.

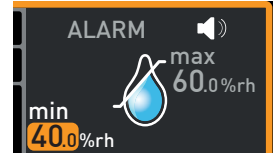
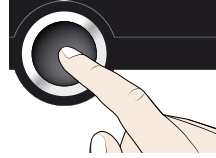

4. By turning the turn control, adjust the desired lower alarm limit, in the example on the right 50 % rh.

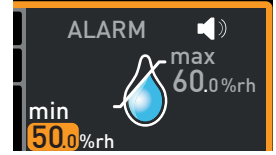

5. Accept the selection by pressing the confirmation key. The upper humidity alarm limit is automatically highlighted.

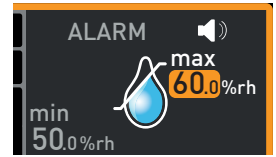
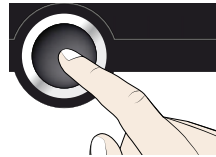

6. By turning the turn control, adjust the desired upper alarm limit, in the example on the right 70 % rh.

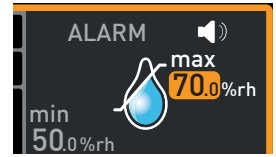
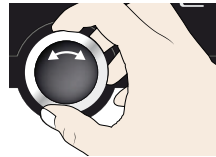

7. Accept the selection by pressing the confirmation key and leave the Alarm display by pressing the activation key on the side. Humidity monitoring is now active.

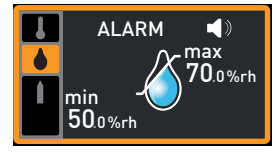
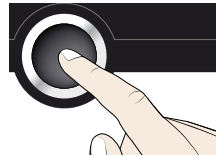

5.6.3 CO₂ monitoring

If CO₂ monitoring was triggered, this is indicated by the CO₂ display: the actual value is highlighted in red and a warning symbol ▲ is shown (Fig. 23). If the acoustic alarm has been activated in menu mode (Sound, see page 62, as indicated by the speaker symbol 🗣️), the alarm is additionally signalled by an intermittent acoustic signal. Information on what to do in this case is provided in chapter Malfunctions, warning and error messages from page 44.

Adjusting CO₂ monitoring

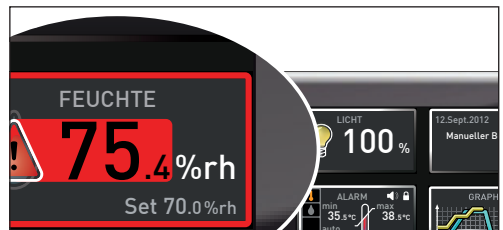
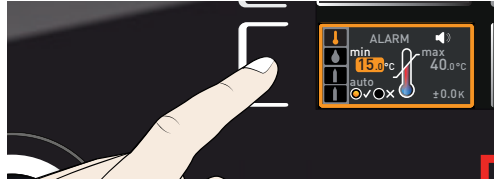

Fig. 23
CO₂ monitoring triggered

1. Press the activation key to the left of the ALARM display. The temperature monitoring setting is automatically activated.



2. Turn the turn control until the CO₂ adjustment entry is selected (upper gas bottle symbol).



3. Accept the selection by pressing the confirmation key. The lower alarm limit is automatically selected.

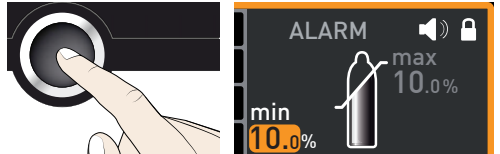

4. By turning the turn control, adjust the desired lower alarm limit, in the example on the right 7 %.

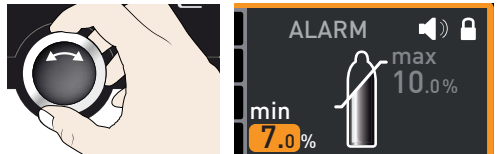

5. Accept the selection by pressing the confirmation key. The upper alarm limit is automatically highlighted.

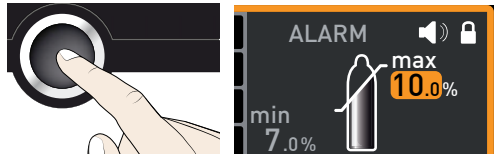

6. By turning the turn control, adjust the desired upper alarm limit, in the example on the right 15 %.

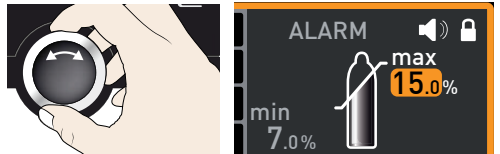

7. Accept the selection by pressing the confirmation key and leave the Alarm display by pressing the activation key on the side. CO₂ monitoring is now active.



Operation and control

5.6.4 O₂ monitoring

(only for appliances in the corresponding configuration)

If O₂ monitoring was triggered, this is indicated by the O₂ display: the actual value is highlighted in red and a warning symbol is shown (Fig. 24). If the acoustic alarm has been activated in menu mode (Sound, see page 62, as indicated by the speaker symbol), the alarm is additionally signalled by an intermittent acoustic signal. Information on what to do in this case is provided in chapter Malfunctions, warning and error messages from page 44.

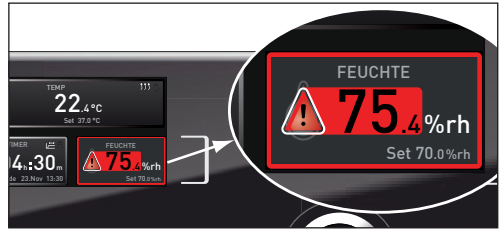
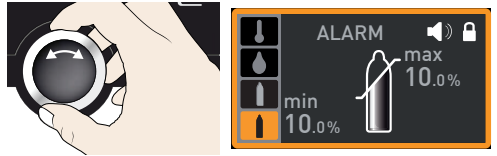

Fig. 24
O₂ monitoring triggered

Adjusting O₂ monitoring

O₂ monitoring is set the same way as CO₂ monitoring (see page 38). After the alarm display is activated, turn the turn control until the O₂ adjustment entry is selected (upper gas bottle symbol), and set the min and max values as described above.



5.7 Graph

The GRAPH display provides an overview of the chronological sequence of the setpoint values and actual values for temperature, humidity, CO₂ and O₂ content as a curve.

Press the activation key to the right of the GRAPH display. The display is enlarged and the temperature profile shown.

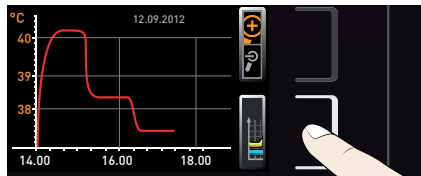

- ▶ To display the setpoint and actual values for humidity, CO₂ and O₂: Press the activation key next to the parameter selection.

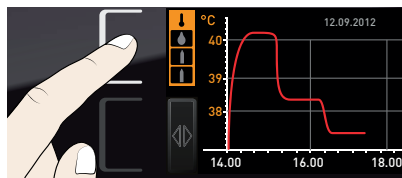

Select the humidity symbol or one of the gas bottle symbols with the turn control. Accept the selection by pressing the confirmation key.

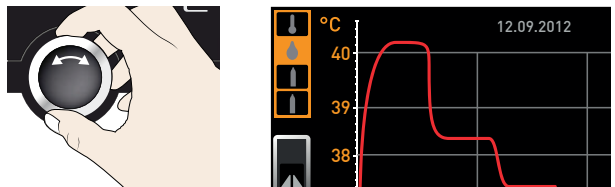

- ▶ To change the time frame to be displayed: Press the activation key next to the <> arrow symbols. The time frame to be displayed can now be changed by turning the turn control.

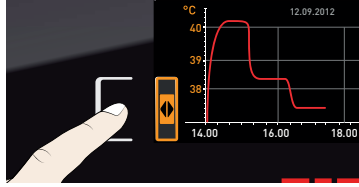

- ▶ To zoom the graph in or out: Press the activation key next to the magnifying glass symbol. Select whether you want to zoom in or out (+/-) with the turn control and confirm your selection by pressing the confirmation key.

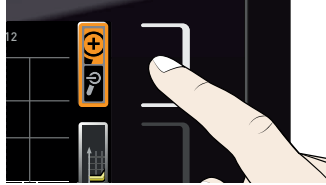

To close the graphical representation, press the activation key you used to activate it again.

5.8 Sterilising the appliance

One or several sterilisation programmes are saved in the appliance. They are used to sterilise the appliance. Do not use them to sterilise medical devices.

The hold time in the appliance's sterilisation programme at 180 °C is 1 h. The total time including heating up and cooling down to 50 °C is 6 h 30 min. At the end of the sterilisation programme, the appliance maintains a constant temperature of 37 °C and the status display shows Steri End.

Appliance sterilisation procedure

1. If there is a HEPA filter in the interior of the fan box (Additional equipment, Fig. 25) is fitted: Remove HEPA filter. It can get damaged during sterilisation.
2. Empty the water trays or, for appliances with active humidity control, open the door briefly to vent the appliance and let the humidity escape.
3. Insert the slide-in units and the water tray with the rubber seal and close the door.

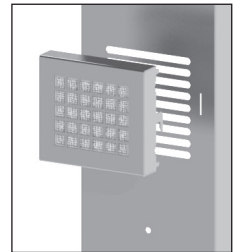

Fig. 25 HEPA filter

4. Check positions of the silicone plugs

NOTICE

The silicone plugs have different temperature resistance properties. Before starting the sterilisation process, check the position of the silicone plugs to see if they are correctly inserted:

- ▶ Interior: white
- ▶ Back of the unit: green

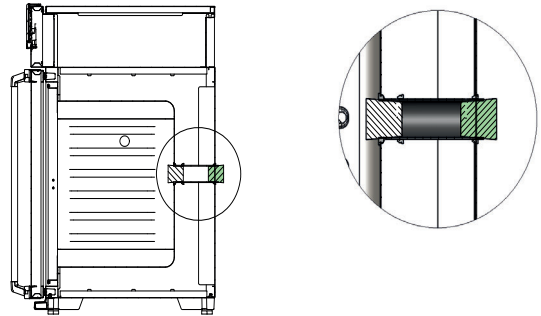

In the menu mode, prepare the sterilisation programme for execution (see page 61).

5. Switch to the operating mode and start the sterilisation programme as described on page 31. You cannot set or change any values as long as the programme is running.

- ### 6. Once sterilisation is finished and the appliance has cooled down to 37 °C, end the sterilisation programme. To do so, press the activation key to the right of the status display. The status display is automatically highlighted.

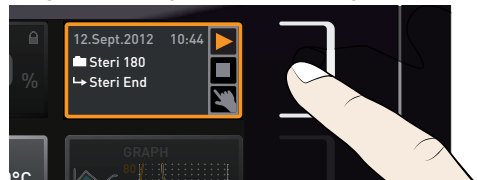

- ### 7. Turn the turn control until the hand symbol is highlighted.

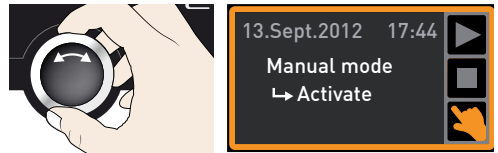

- ### 8. Press the confirmation key to confirm.
- ### 9. Replace the HEPA filter in the interior (optional).

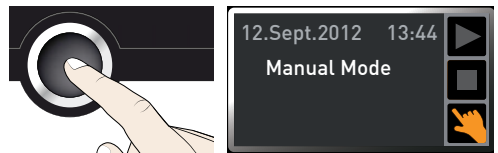

You can now load the appliance and continue to operate it as usual. You have to enter all set values again (temperature, CO₂, O₂, humidity), see chapter 5.5.4.

5.9 Ending operation

1. Switch off active appliance functions (turn back the set values).
2. Close the valves on the gas bottles.
3. Remove the chamber load.
4. Check and, if required, fill up the water tank (see page 22) or remove the water tray(s) of appliances with passive humidity control.
5. Switch off the appliance with the main switch (Fig. 26).

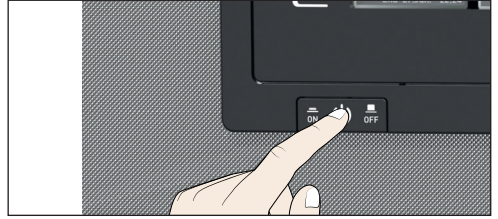

Fig. 26 Switching off the appliance

6. Malfunctions, warning and error messages

⚠ WARNING



After removing covers, live parts may be exposed. You may receive an electric shock if you touch these parts. Do not try to rectify appliance errors yourself by opening the appliance, instead, contact the MEMMERT customer service department (see page 2) or an authorised service point.

6.1 Warning messages of the monitoring function

i If the acoustic alarm has been activated in the menu mode (Sound, see page 62, indicated by the speaker symbol ), the alarm is additionally signalled by an intermittent acoustic signal. If the confirmation key is pressed, the acoustic alarm can be temporarily switched off until the next alarm event occurs.

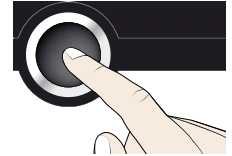

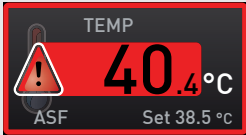
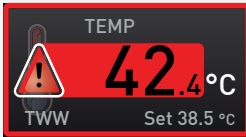
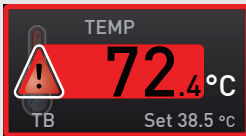

6.1.1 Temperature monitoring

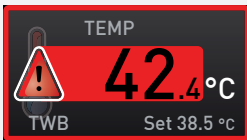
Description	Cause	Action	See
Temperature alarm and "ASF" are displayed 	Automatic temperature monitor (ASF) was triggered.	Check if the door is closed. Close the door. Increase the ASF tolerance band. If the alarm continues: Contact customer service	Page 35 Page 2
Temperature alarm and "TWW" are displayed 	The adjustable temperature controller (TWW) has assumed heating control.	Increase the difference between the monitoring and setpoint temperature – by either increasing the max value of the temperature monitoring or decreasing the setpoint temperature. If the alarm continues: Contact customer service	Page 35 Page 2
Temperature alarm and "TB" are displayed 	The mechanical temperature limiter (TB) permanently switched off heating.	Switch off the appliance and leave to cool down. If the error occurs again, contact customer service.	Page 2

Description	Cause	Action	See
Temperature alarm and "TWB" are displayed 	The electronic temperature limiter (TWB) permanently switched off heating.	Deactivate the alarm by pressing the confirmation key. Increase the difference between the monitoring and setpoint temperature - by either increasing the max value of the temperature monitoring or decreasing the setpoint temperature. If the alarm continues: Contact customer service	Page 35 Page 2

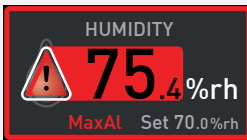
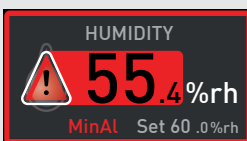

6.1.2 Humidity monitoring (only for appliances in the corresponding configuration)

Description	Cause	Action	See
Error display symbol  	Water tank empty	Fill the water tank with demineralised/distilled water and press the confirmation key	Page 22
Alarm display (MaxAl) 	Upper humidity limit exceeded	Open the door for 30 sec. and wait to see if the appliance reliably adjusts to the setpoint. If the error occurs again, contact customer service.	Page 2
Alarm display (MinAl) 	Humidity below lower limit	Check if the door is closed. Check the water supply and the fill level of the water tank / water trays. If required, refill the water tank / water trays. If the error occurs again, contact customer service.	Page 22 Page 2

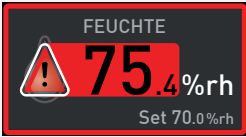
6.1.3 CO₂ Monitoring



Description	Cause	Action	See
<p>Alarm indicates that the upper CO₂ alarm limit was exceeded</p> 		<p>Open the door for 30 sec. and wait to see if the appliance then steadily adjusts to the setpoint.</p> <p>If the error occurs again, contact customer service.</p>	Page 2
<p>Alarm indicates that the lower CO₂ alarm limit was undercut</p> 		<p>Check if the door is closed.</p> <p>Check that the lines are connected correctly, check the valve and level of the gas bottle. If necessary, connect a new gas bottle.</p> <p>If the error occurs again, contact customer service.</p>	Page 22

6.1.4 O₂ monitoring

Description	Cause	Action	See
<p>Alarm indicates that the upper O₂ alarm limit was exceeded</p> 		<p>Check the N₂ supply and the fill level of the gas bottle.</p> <p>If the error occurs again, contact customer service.</p>	Page 2
<p>Alarm indicates that the lower O₂ alarm limit was undercut</p> 		<p>Open the door for 30 sec. and wait to see if the appliance then steadily adjusts to the setpoint.</p> <p>If the error occurs again, contact customer service.</p>	Page 2

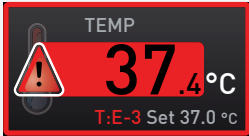
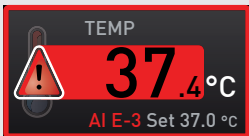
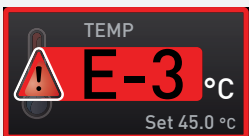
6.2 Malfunctions, operating problems and appliance errors

Description	Cause	Action	See
Displays are dark	External power supply was interrupted	Check the power supply	Page 21
	Miniature fuse, appliance fuse or power module faulty	Contact customer service	Page 2
Displays cannot be activated	Appliance locked by USER ID	Unlock with USER ID	Page 64
	The appliance is in programme, timer or remote control mode (mode "Write" or "Write + Alarm")	Wait until the end of the programme or timer mode or switch off the remote control	
Displays suddenly look different	Appliance is in "wrong" mode	Change to operating or menu mode by pressing the MENU key	
Error message T:E-3 in the temperature display 	Temperature operating sensor is defective. The monitoring sensor takes over the measurement function.	<ul style="list-style-type: none"> ▶ The appliance can temporarily be kept in service ▶ Contact customer service as soon as possible 	Page 2
Error message AI E-3 in the temperature display 	Temperature monitoring sensor is defective. The operating sensor takes over the measurement function.	<ul style="list-style-type: none"> ▶ The appliance can temporarily be kept in service ▶ Contact customer service as soon as possible 	Page 2
Error message E-3 in the temperature display 	Operating and monitoring sensor defective	<ul style="list-style-type: none"> ▶ Switch off appliance ▶ Remove the chamber load ▶ Contact customer service 	Page 2

Description	Cause	Action	See
Error message E-6 in the humidity display 	Humidity sensor defective	<ul style="list-style-type: none"> ▶ No humidity control possible ▶ Contact customer service 	Page 2
Error message E-5 in the CO ₂ display 	CO ₂ sensor is defective	<ul style="list-style-type: none"> ▶ No CO₂ control possible ▶ Contact customer service 	Page 2
	Working temperature after cycle Sterilization program exceeded	▶ Allow appliance to cool down	Page 31
When switching on the appliance, the "start" animation is displayed in another colour than white ●●●●	<ul style="list-style-type: none"> ▶ Cyan ●●●●: Not enough storage space on the SD card ▶ Red ●●●●: The system files could not be loaded ▶ Orange ●●●●: The fonts and images could not be loaded 	Contact customer service Contact customer service Contact customer service	Page 2 Page 2 Page 2

6.3 Power failure

In case of a power failure, the appliance operates as follows:

In manual mode

After power supply has been restored, operation is continued with the parameters set. The time and duration of the power failure are documented in the log memory.

In timer or programme mode

In case of an interruption of the power supply of less than 60 minutes, the current programme is continued from the point at which it was interrupted. For longer interruptions of the power supply, all appliance functions (heating, fan etc.) are switched off.

The sterilisation time is reset if the temperature drops while the sterilisation programme is running.

In remote control mode

The previous values are restored. If a programme has been initiated via remote control, it is continued.

7. Menu mode

In menu mode, you can make basic settings, load programmes and export protocols, as well as calibrate the appliance.

NOTICE

- ▶ Before changing menu settings, read the description of the respective functions on the following pages to avoid possible damage to the appliance and/or chamber load.

To enter menu mode, press the MENU key.

- 1 To exit the menu mode at any time, press the MENU key again. The appliance then returns to operating mode. Only changes that are accepted by pressing the confirmation key are saved.

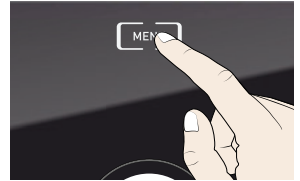

7.1 Overview

Press the MENU key to change between the displays in menu mode:

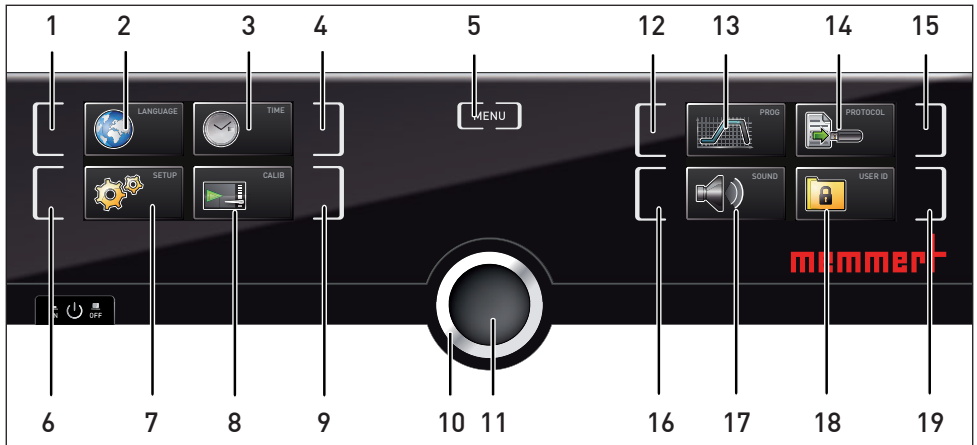

Fig. 27 ControlCOCKPIT in menu mode

- | | |
|---|--|
| <ul style="list-style-type: none"> 1 Language selection activation key 2 Language selection display 3 Date and time display 4 Date and time setting activation key 5 Exit menu mode and return to operating mode 6 Setup activation key (basic appliance settings) 7 Setup display (basic appliance settings) 8 Adjustment display 9 Adjustment activation key | <ul style="list-style-type: none"> 10 Turn control for adjustment 11 Confirmation key (accepts setting made with the turn control) 12 Programme selection activation key 13 Programme selection display 14 Protocol display 15 Protocol activation key 16 Acoustic signal adjustment activation key 17 Acoustic signal adjustment display 18 USER ID display 19 USER ID display activation key |
|---|--|

7.2 Basic operation in menu mode using the example of language selection

In general, all settings in menu mode are done just like in operating mode: Activate the respective display, use the turn control for setting and press the confirmation key to accept the change. A more detailed description is provided in the following, using the example of language selection.

1. Activate the desired parameter (in this example the language). To do so, press the corresponding activation key on the left or right of the respective display. The activated display is enlarged.

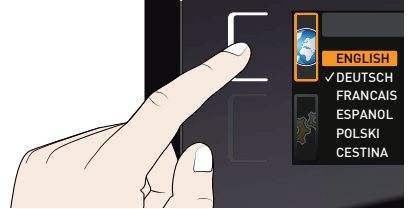

1. If you want to exit or cancel the settings, press the activation key you used to activate the display again. The appliance returns to the menu overview. Only the settings that you have confirmed by pressing the confirmation key before cancelling the setting procedure are accepted.



2. With the turn control, select the desired new setting, e.g. Español (Spanish).

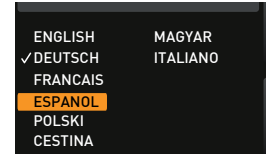

3. Save the setting by pressing the confirmation key.

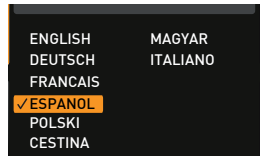
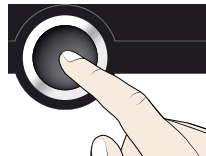

4. To return to the menu overview, press the activation key again.

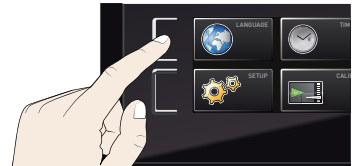

You can now

- ▶ activate another menu function by pressing the corresponding activation key or
- ▶ return to operating mode by pressing the MENU key.

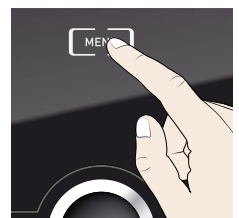
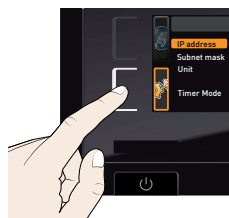

All other settings can be made accordingly. The settings possible are described in the following sections.

i If no new values are entered or confirmed for approx. 30 seconds, the appliance automatically restores the former values.

7.3 Setup

7.3.1 Overview

In the SETUP menu, you can set the following parameters:

- ▶ the IP address and subnet mask of the appliance's Ethernet interface (for connection to a network)
- ▶ the temperature display unit (°C or °F, see page 52)
- ▶ how the digital backwards counter with target time setting works (Timer Mode, see page 53)
- ▶ Remote control (see page 53)
- ▶ Gateway (see page 53)

i If the Setup menu contains more entries than can be displayed, this is indicated by the display "1/2". This means that there is a second "page" of entries.

To display the hidden entries, use the turn control to scroll beyond the lowest entry. The page display changes to "2/2".

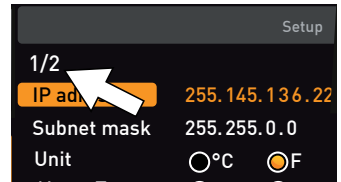

7.3.2 IP address and subnet mask

If you want to operate one or more appliances in a network, each appliance must have its own unique IP address for identification. By default, each appliance is delivered with the IP address 192.168.100.100.

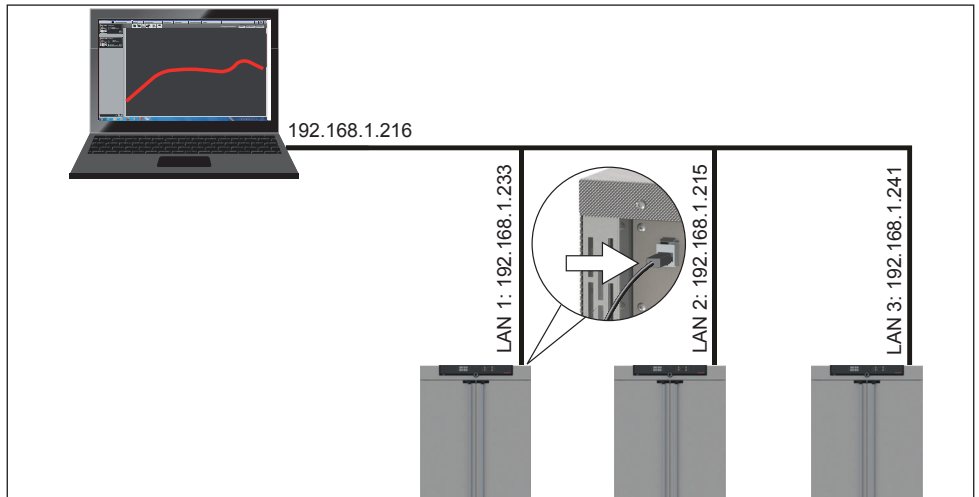
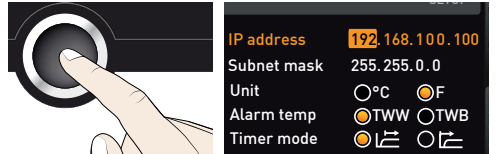

Fig. 28 Operation of several appliances in a network (schematic example)

1. Activate the SETUP display. The entry IP address is automatically highlighted.



2. Accept the selection by pressing the confirmation key. The first three digits of the IP address are automatically selected.



3. With the turn control, set the new number, e.g. 255.

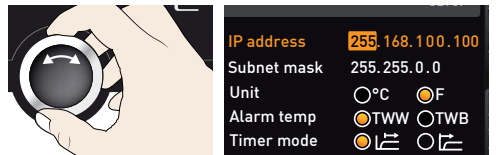

4. Accept the selection by pressing the confirmation key. The next three digits of the IP address are automatically selected. Setting these is done according to the description above.

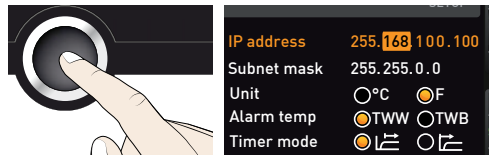

5. After setting the last three digits, accept the new IP address by pressing the confirmation key. The selection returns to the overview. The subnet mask is set accordingly.

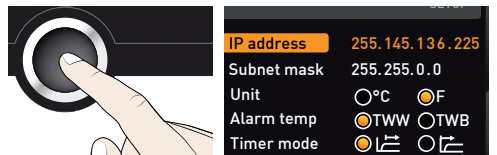

Unit

Here, you can choose whether the temperature is displayed in °C or °F.

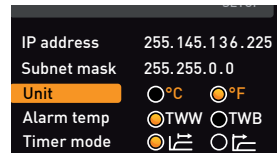

7.3.3 Timer Mode

Here, you can choose whether the digital backwards counter with target time setting (see page 30, timer) should run setpoint-dependent or not – this determines whether the timer should not start until a tolerance band of ± 3 K around the set temperature is reached (Fig. 29, B) or whether it should start right after activation (A).

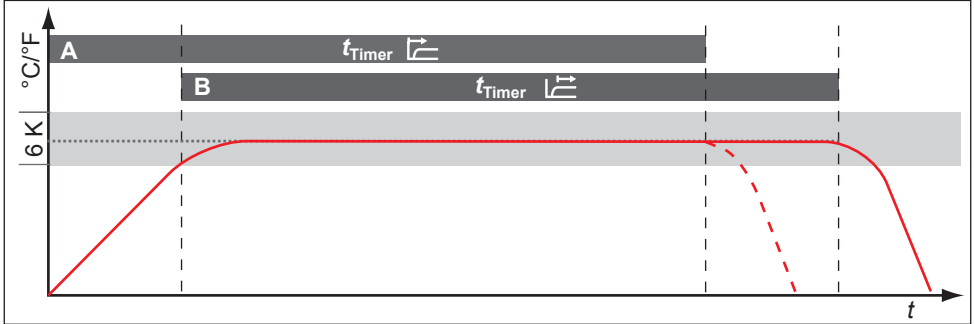
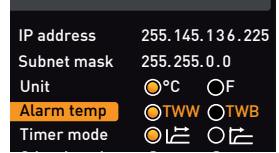

Fig. 29 Timer mode

- A Timer independent of setpoint: Timer starts right after activation
- B Timer setpoint-dependent: Timer does not start until tolerance band is reached

7.3.4 Remote control (AtmoREMOTE)

In the "remote control" setup entry, you can set whether the appliance should be controlled via remote control and if so, in which mode. These settings are available:

- ▶ Off
- ▶ Read only
- ▶ Write + Read
- ▶ Write + Alarm

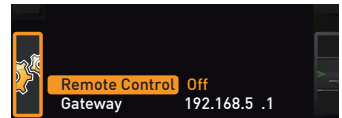

If the appliance is in remote control mode, the symbol appears in the temperature display. In the settings Write + Read and Write + Alarm, the appliance cannot be controlled at the ControlCOCKPIT unless the remote control is switched off (setting Off) or set to Read only.

In order to use the remote control function, programming skills and special libraries are required.

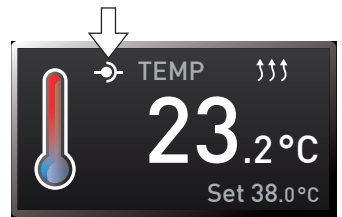

7.3.5 Gateway

The setup entry gateway is used to connect two networks with different protocols.

The gateway is set the same way as the IP address (see page 51).

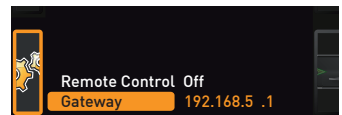

7.4 Date and time

In the TIME display, you can set the date and time, time zone and daylight saving time. Changes can only be made in manual operating mode.

NOTICE

Always set the time zone (and daylight saving time yes/no) before you set the date and time. Avoid changing the set time after that since this can lead to gaps or overlapping when recording measured values. If you still need to change the time, you should not run a programme immediately before or after doing so.

1. Activate the time setting. To do so, press the activation key on the right side of the TIME display. The display is enlarged and the first adjustment option (Date) automatically highlighted.

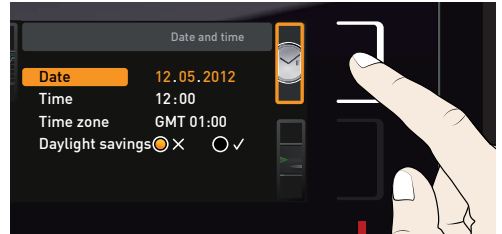

2. Turn the turn control until Time zone is highlighted.

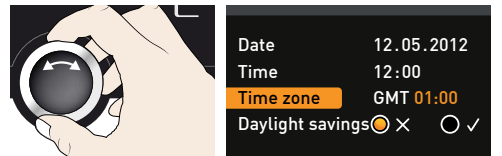

3. Accept the selection by pressing the confirmation key.

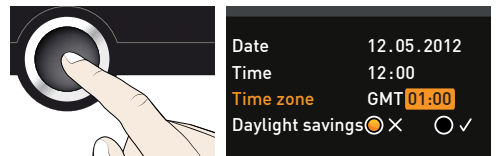

4. Set the time zone of the installation site with the turn control, e.g. 00:00 for Great Britain and 01:00 for Germany, France or Spain. Accept the selection by pressing the confirmation key.

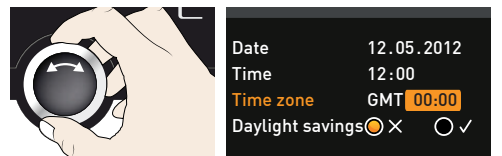

5. With the turn control, select the Daylight savings entry.

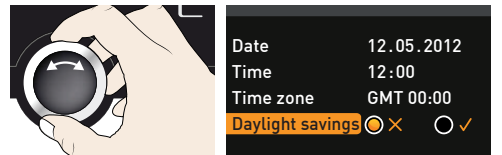

6. Accept the selection by pressing the confirmation key. The adjustment options are highlighted.

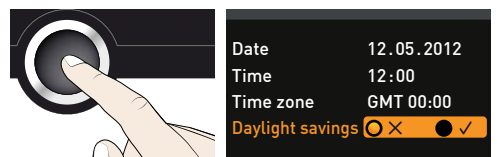

- Set daylight savings to off (X) or on (✓) with the turn control – in this case on (✓). Save the setting by pressing the confirmation key.

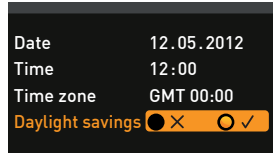
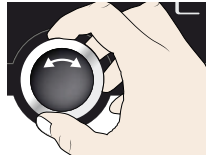

i Daylight saving time and standard time are not changed automatically. For this reason, please keep in mind to adjust them at the beginning of each period.

- Now, set date (day, month year) and time (hours, minutes) in the same way. Accept the selection by pressing the confirmation key.

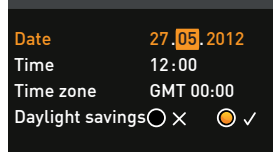

7.5 Calibration

NOTICE

To guarantee perfect control, we recommend to calibrate the appliance once a year. The calibration possibilities depend on the appliance configuration.

7.5.1 Temperature calibration

The appliances are temperature calibrated and adjusted at the factory. In case readjustment should be necessary later on – for example due to influence of the chamber load – the appliance can be calibrated customer-specifically using three calibration temperatures of your choice:

- ▶ Cal1 Temperature calibration at low temperature
- ▶ Cal2 Temperature calibration at medium temperature
- ▶ Cal3 Temperature calibration at high temperature

i For temperature calibration, you will need a calibrated reference measuring device.

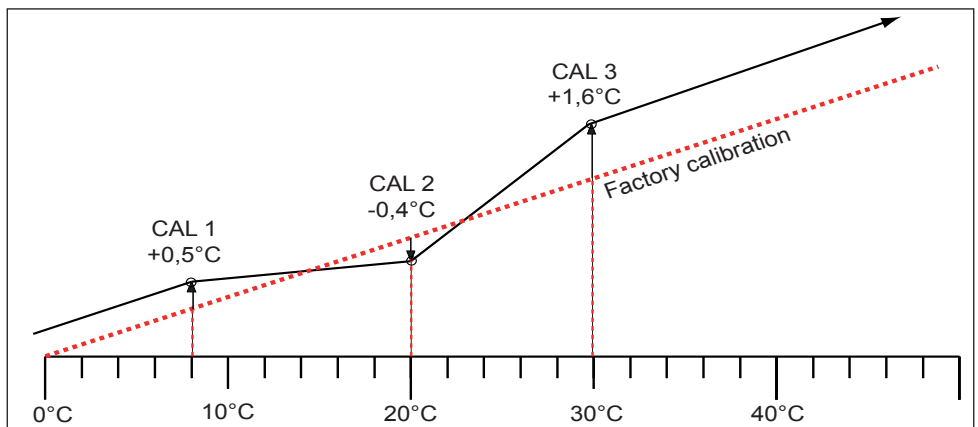
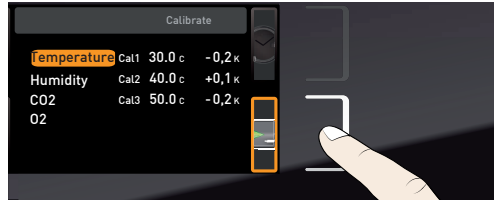

Fig. 30 Schematic example of temperature calibration

Example: Temperature deviation at 42 °C should be corrected.

1. Press the activation key to the right of the CALIB display. The display is enlarged and the temperature adjustment option is automatically selected.



2. Press the confirmation key repeatedly, until the calibration temperature Cal2 is selected.

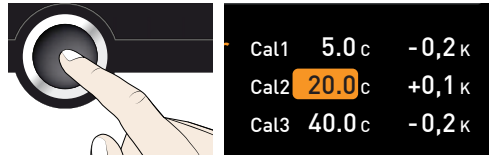

3. With the turn control, set the calibration temperature Cal2 to 42 °C.

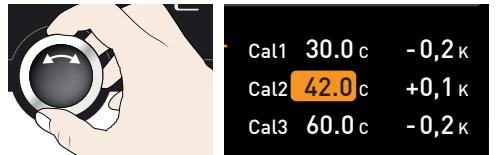

4. Save the setting by pressing the confirmation key. The corresponding calibration value is automatically highlighted.

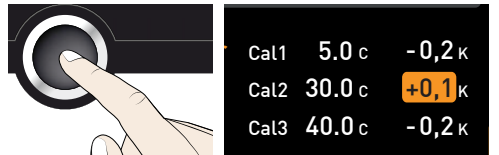

5. Set the calibration value to 0.0 K and accept the setting by pressing the confirmation key.

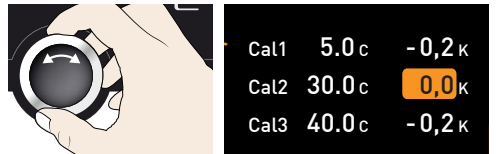

6. Position the sensor of a calibrated reference instrument centrally in the appliance's working chamber. For this, use the feed-through in the inner glass door.

7. Close the door and, in manual mode, adjust the set temperature to 42 °C.

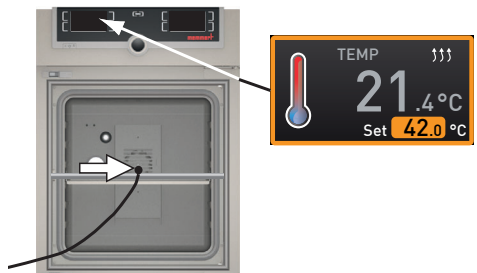

8. Wait until the appliance reaches the set temperature and displays 42 °C. The reference instrument should display 43.6 °C.



9. In the SETUP, adjust the calibration value Cal2 to +1.6 K (measured reference value minus displayed value) and save the setting by pressing the confirmation key.



Cal1	5.0 c	-0,2 K
Cal2	30.0 c	+1,6 K
Cal3	40.0 c	-0,2 K

10. After the calibration procedure, the temperature measured by the reference instrument should now also be 42 °C.

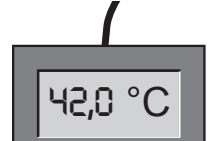
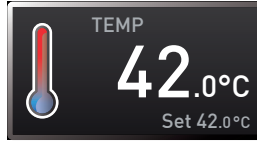

With Cal1, a calibration temperature below Cal2 can be programmed accordingly, and with Cal3, a temperature above. The minimum interval between the Cal values is 10 K.

i If all calibration values are set to 0.0 K, the factory calibration settings are restored.

7.5.2 Humidity calibration

(only for appliances with active humidity control)

You can adjust the humidity according to customer requirements with the two freely selectable balance points. For each selected calibration point, a positive or negative compensation correction value between -10 % and +10 % can be set (Fig. 31).

i For temperature calibration, you will need a calibrated reference measuring device.

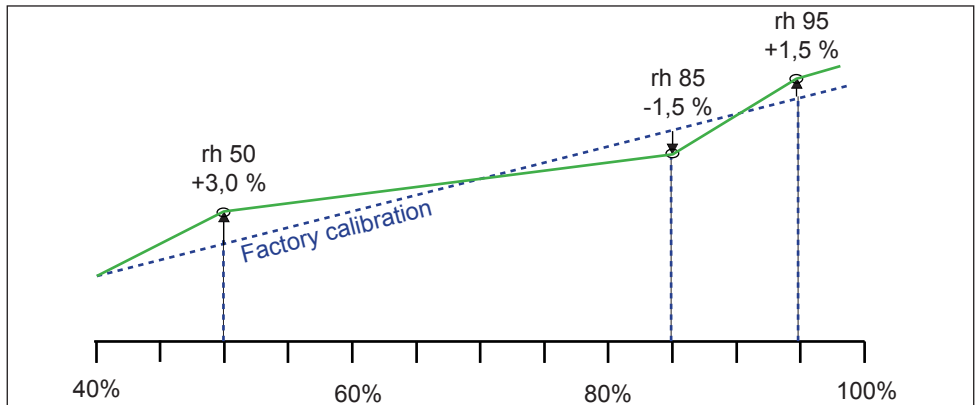

Fig. 31 Humidity calibration (example)

Example: Humidity deviation at 60 % should be corrected:

1. Press the activation key to the right of the CALIB display. The display is enlarged and the temperature adjustment option is automatically selected.



2. Turn the turn control until Humidity is highlighted.

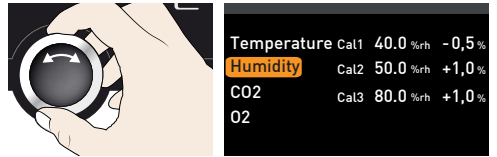

3. Press the confirmation key repeatedly, until the calibration point Cal2 is selected.

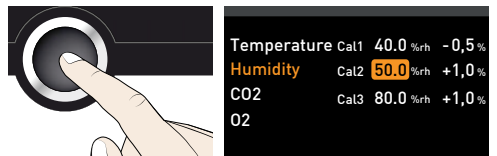

4. With the turn control, set the calibration point Cal2 to 60 % rh.

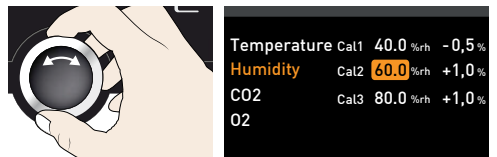

5. Save the setting by pressing the confirmation key. The corresponding calibration value is automatically highlighted.

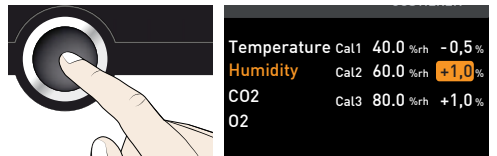

6. Set the calibration value to 0.0 % and accept the setting by pressing the confirmation key.

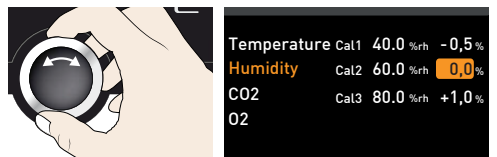

7. Position the sensor of the calibrated reference instrument centrally in the working chamber of the appliance. For this, use the feed-through in the inner glass door.



8. Close the door and, in manual mode, adjust the set humidity to 60 % rh.

9. Wait until the appliance reaches the set humidity and displays 60 % rh. The reference instrument should display 58.5 % rh.

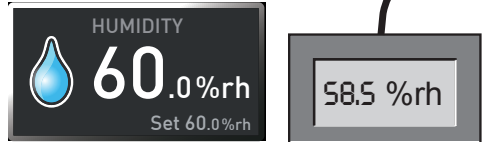

10. In the SETUP, adjust the calibration value Cal2 to -1.5 % (measured reference value minus displayed value) and save the setting by pressing the confirmation key.

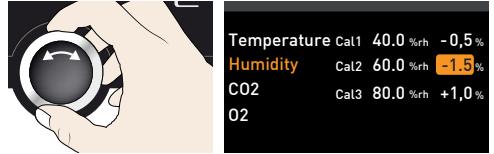

11. After the calibration procedure, the humidity measured by the reference instrument should now also be 60 % rh.

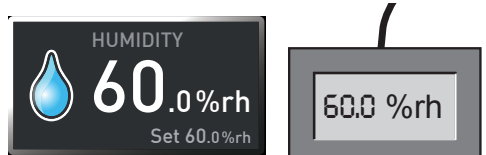

7.5.3 CO₂ and O₂ calibration

You can calibrate the CO₂ and O₂ control (O₂ only in the corresponding configuration) according to customer requirements with three freely selectable balance points. You can set a positive or negative compensation correction values for each selected balance point(Fig. 32).

1 For CO₂ calibration, a calibrated CO₂ measuring instrument is required;for O₂ calibration, a calibrated O₂ measuring instrument is required.

The procedure for CO₂ and O₂ calibration is identical. This is explained with the example of CO₂ in the following.

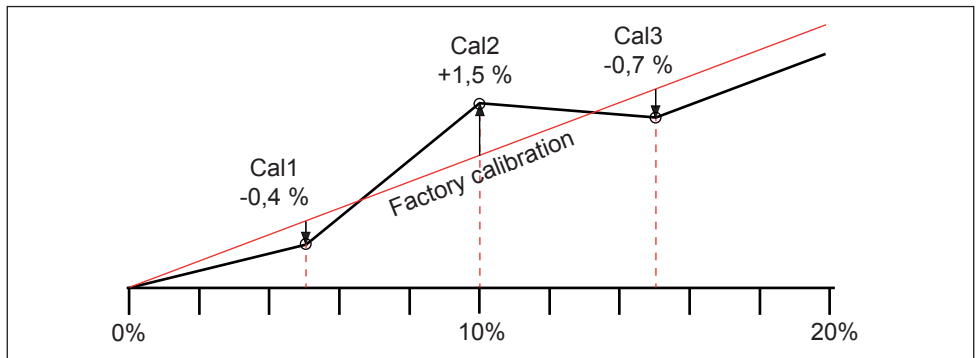
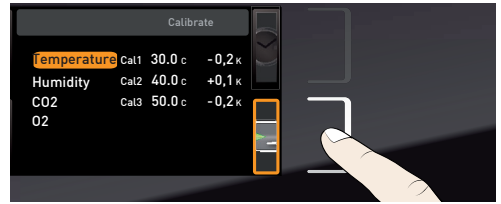

Fig. 32 CO₂ calibration (example)

Example: A CO₂ deviation of 10 % or more should be corrected.

1. Press the activation key to the right of the CALIB display. The display is enlarged and the temperature adjustment option is automatically selected.



2. Turn the turn control until CO2 or O2 is selected.

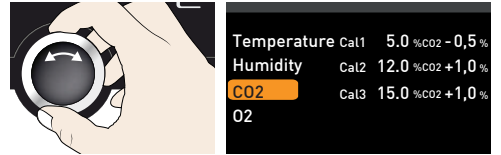

3. Press the confirmation key repeatedly, until the calibration point Cal2 is selected.

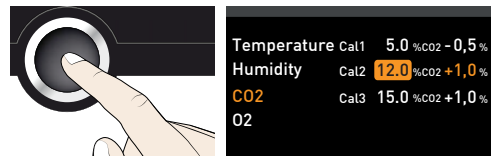

4. With the turn control, set the calibration point Cal2 to 10 %.

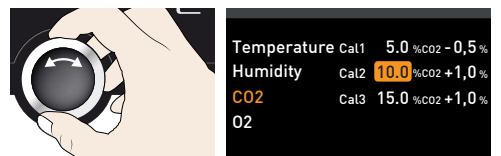

5. Save the setting by pressing the confirmation key. The corresponding calibration value is automatically highlighted.

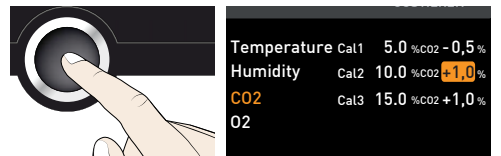

6. Set the calibration value to 0.0 % and accept the setting by pressing the confirmation key.

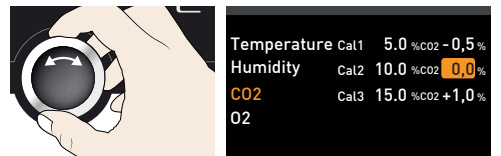

7. Position the sensor of the calibrated reference instrument centrally in the working chamber of the appliance. For this, use the feed-through in the inner glass door.
8. Close the door and, in manual operating mode, adjust the CO₂ content setpoint to 10 %.



9. Wait until the appliance reaches the setpoint and displays 10 %. The reference instrument displays 8.5 %, for example.

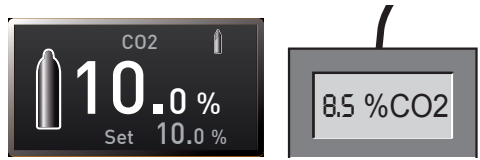

10. In the SETUP, adjust the calibration value Cal2 to -1.5 % (reference value measured minus value displayed) and save the setting by pressing the confirmation key.

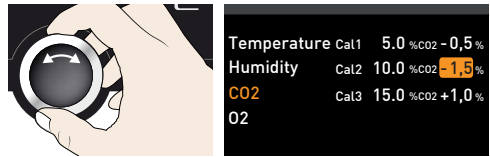

11. After the calibration procedure, the CO₂ value measured by the reference instrument should now also be 10 %.

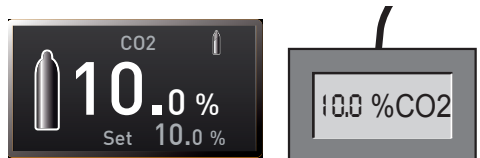

7.6 Programme

In the Program display, programmes created using the AtmoCONTROL software can be transferred to the appliance and saved on a USB storage medium. Here, you can also select the programme provided for use (see page 31) and delete programmes.

NOTICE

One or several default sterilisation programmes are saved in the appliance. They only serve to sterilise the appliance itself and must not be used to sterilise medical devices.

i To load a programme from a USB storage medium: Connect the USB storage medium with the saved programme(s) to the interface on the right side of the ControlCOCKPIT.

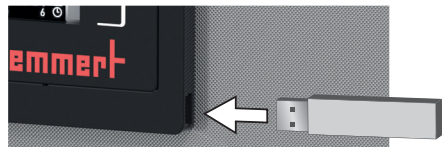

1. Activate the programme display. To do so, press the activation key on the left side of the Prog display. The display is enlarged and the entry Select is automatically highlighted. The programmes available for activation are shown on the right. The programme currently available for use – in this example Test 012 – is highlighted in orange.

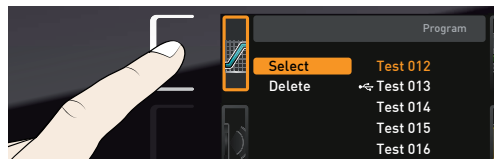

2. Access the Select function by pressing the confirmation key. All programmes available are displayed, including the ones saved on the USB storage medium (identified by the USB symbol ). The programme currently available for use is highlighted in orange.
3. With the turn control, select the programme you want to make available for use, in this example the sterilisation programme Steri 180.
4. Accept the selection by pressing the confirmation key. The programme is loaded and provided for use.
5. As soon as the programme is ready, the selection returns to Select. To start the programme: Return to operating mode by pressing the MENU key and start the programme as described on page 31.

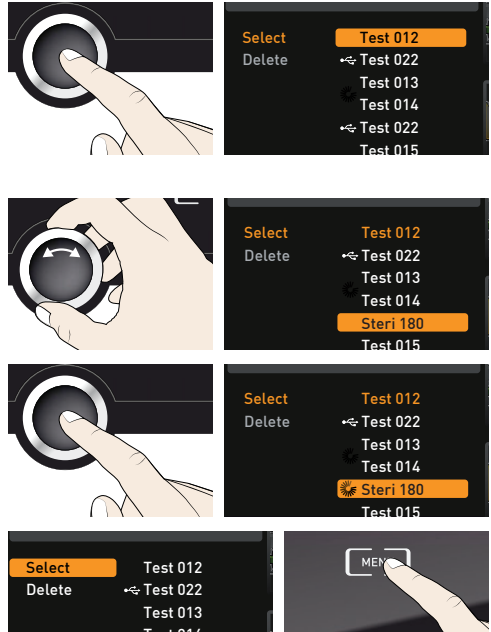

If you connected a USB storage medium, you can now remove it.

To delete a programme, select Delete with the turn control and select the programme to be deleted the same way you can select a programme for activation. Sterilisation programmes cannot be deleted.

7.7 Sounds

In the SOUND display, you can define whether or not the appliance should emit acoustic signals and, if yes, define for which events it should do so:

- ▶ on the press of a key
- ▶ at the end of a programme
- ▶ On alarm
- ▶ if the door is open

1. Activate the acoustic signal adjustment. To do so, press the activation key on the left side of the SOUND display. The display is enlarged. The first category (in this case Keysound) is automatically highlighted. On the right, the current settings are shown on.

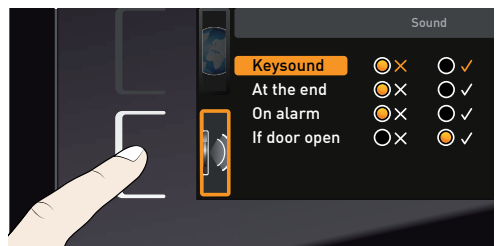

1 If you want to edit another list entry: Turn the turn control until the respective entry – e.g. if door open (special configuration) – is highlighted in colour.

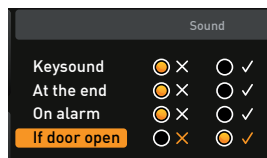

2. Save the selection by pressing the confirmation key. The adjustment options are automatically highlighted.

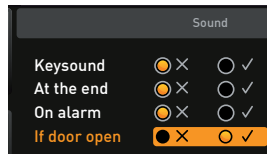
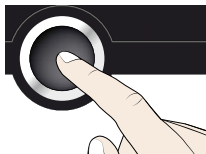

3. With the turn control, select the desired setting – in this example OFF (X).

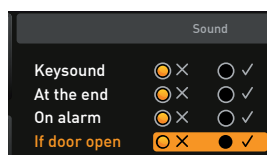

4. Save the setting by pressing the confirmation key.

1 If an acoustic alarm sounds, it can be turned off by pressing the confirmation key.

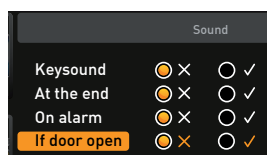
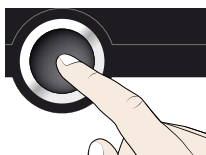

7.8 Protocol

The appliance continually logs all relevant measured values, settings and error messages at 1-minute intervals. The internal log memory is of the continuous memory type. The logging function cannot be switched off and is always active. The measured data are stored in the appliance, safe from manipulation. If the power supply is interrupted, the time of the power failure and voltage recovery are stored in the appliance.

You can export the protocol data for different periods to a USB storage medium via the USB interface or, via Ethernet, import them to the AtmoCONTROL software for graphical representation, print-out or storage.

1 The log memory of the appliance is not modified or deleted by reading it out.

1. Connect the USB storage medium to the interface on the right side of the ControlCOCKPIT.

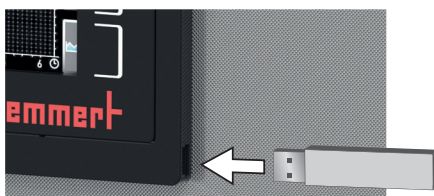

Menu mode

2. Activate the protocol. To do so, press the activation key on the right side of the PROTOCOL display. The display is enlarged and the period This Month is automatically highlighted. To select another logging period, use the turn control.
3. Save your selection by pressing the confirmation key. The transfer starts and a status symbol indicates the progress.
4. As soon as the transfer is complete, a check mark appears in front of the period selected. You can now remove the USB storage medium.

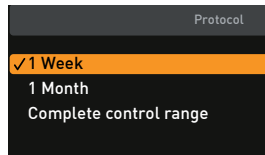
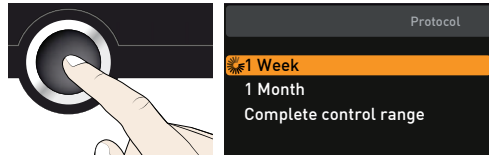
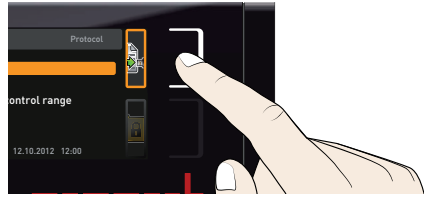

For a description of how to import and process protocol data in AtmoCONTROL or read them out via Ethernet, please observe the separate AtmoCONTROL manual.

7.9 USER ID

7.9.1 Description

With the USER ID function, you can lock the settings of individual (e.g. temperature) or all parameters, so that they cannot be changed at the appliance by accident or unauthorised persons. You can also lock setting options in menu mode (e.g. adjustment or date and time settings) this way.

- If adjustment options are locked, this is indicated by the lock symbol in the respective display (Fig. 33).

USER ID data is entered in the AtmoCONTROL software and saved on the USB storage medium. The USB storage medium is thus acting as a key: Parameters can only be locked or unlocked if it is connected.



A description of how to create a USER ID in AtmoCONTROL is provided in the separate AtmoCONTROL manual.

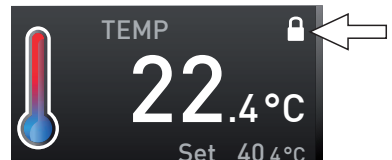
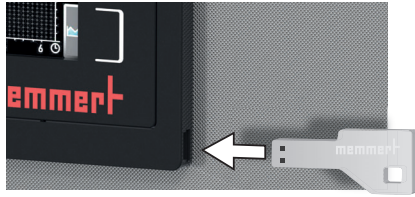

Fig. 33 Temperature adjustment at appliance locked (example)

7.9.2 USER ID activation and deactivation

1. Connect the USB storage medium with the USER ID data to the interface on the right side of the ControlCOCKPIT.



2. Activate the USER ID. To do so, press the activation key on the right side of the USER ID display. The display is enlarged and the entry Activate is automatically highlighted.

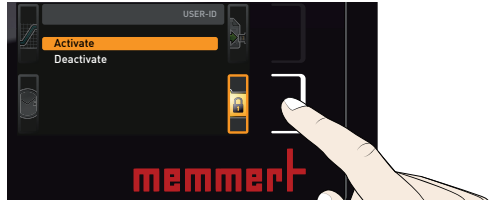

3. Confirm the activation by pressing the confirmation key. The new USER ID data are transferred from the USB storage medium and activated. As soon as activation is complete, a check mark appears in front of the corresponding entry.

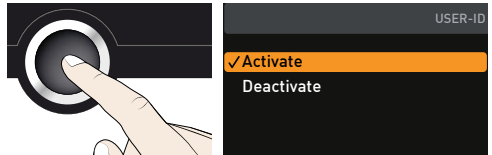

4. Remove the USB storage medium. Locked parameters are indicated by the lock symbol in the respective display (Fig. 33).

To unlock the appliance, connect the USB storage medium, activate the USER ID display and select the entry Deactivate.

8. Maintenance and Servicing

WARNING



Danger due to electric shock. Disconnect the mains plug before any cleaning or maintenance work.

8.1 Regular maintenance

Annually:

- ▶ Check the sterile filters and the water pump filters in the control unit and replace them if they are dirty.
- ▶ To guarantee perfect control, we recommend to calibrate the appliance once a year (see page 55).

Every two years:

- ▶ Replace all sterile filters and water pump filters in the control unit.

8.2 Cleaning

8.2.1 Interior and metal surfaces

Regular cleaning of the easy-to-clean interior prevents build up of material remains that could impair the appearance and functionality of the stainless steel chamber over time.

The metal surfaces of the appliance can be cleaned with normal stainless steel cleaning agents. Make sure that no rusting objects come into contact with the interior or with the stainless steel housing. Rust deposits can lead to an infection of the stainless steel. If rust spots appear on the surface of the interior due to impurities, immediately clean and polish the affected area.

8.2.2 Plastic parts

Do not clean the ControlCOCKPIT and other plastic parts of the appliance with caustic or solvent-based cleaning agents.

8.2.3 Glass surfaces

Glass surfaces can be cleaned with a commercially available glass cleaner.

8.3 Repairs and Service

Only authorised customer service points may carry out maintenance work.

9. Storage and disposal

9.1 Storage

The appliance may only be stored under the following conditions:

- ▶ in a dry and enclosed, dust-free room
- ▶ frost-free
- ▶ disconnected from the power supply and gas supply

Close the valves of the gas bottles and disconnect the hoses. Gas bottles may only be stored in closed rooms if these are sufficiently ventilated.

Disconnect the tube of the water supply tank and empty it.

9.2 Disposal

This product is subject to the Directive 2012/96/EC on Waste Electrical and Electronic Equipment (WEEE) of the European Parliament and of the Council. This appliance has been brought to market after August 13th, 2005 in countries which have already integrated this directive into their national laws. It may not be disposed of in normal household waste. For disposal, please contact your dealer or the manufacturer. Any appliances that are infected, infectious or contaminated with materials hazardous to health are excluded from return. Please also observe all other regulations applicable in this context.

Before disposing of the appliance, please render the door locking mechanism unusable, for example to prevent playing children from being locked inside the appliance.

There is a lithium battery in the ControlCOCKPIT of the appliance. Remove it and dispose of it in accordance with the regulations in your country (Fig. 35).



Fig. 35 Removing the lithium battery

Index

- A**
- Accessories 15
 - Accidents 9
 - Activation button 27
 - Alarm 32, 33, 35, 37, 38, 41
 - Ambient conditions 15
 - Ambient temperature 15
 - Appliance error 43
 - ASF 32, 33
 - AtmoCONTROL 3, 12, 15, 27, 30, 58, 60, 61
- B**
- Basic device settings 46
 - Basic settings 46
- C**
- Calibration 52
 - Cancel programme 31
 - Carrying 16
 - Chamber load 25
 - Changes 9
 - Cleaning 63
 - CO₂ 29
 - CO₂ connection 21
 - CO and O calibration 56
 - Cold burns 7
 - Communication interfaces 11
 - CO monitoring 37
 - Compensation correction values 54
 - Connections 11
 - ControlCOCKPIT 25, 26
 - Customer service 2
- D**
- Danger of suffocation 7
 - Date 51
 - Declaration of conformity 14
 - Decommissioning 64
 - Delete programme 59
 - Delivery 16, 17, 20
 - Digital backwards counter with target time setting 29
 - Dimensions 14
 - Directives 14
 - Disposal 64
 - Door 24
- E**
- Electrical connection 11
 - Electrical equipment 11
 - Electronic temperature monitoring 32
 - Emergency 9
 - Ending operation 40
 - End of programme 31
 - Error message 44, 45
 - Error messages 41
 - Ethernet 12
 - Explosion protection 8
- F**
- Fan speed 29
 - Forklift truck 17
 - Fresh water container 21
- G**
- Gas bottles 6, 7, 8, 9, 20
 - Gas connection 21
 - Gas leakage 9
 - Gateway 50
 - Graph 37, 38
- H**
- Hazards 6
 - Hot-air generator 10
 - Humidity 28
 - Humidity adjustment 54
 - Humidity monitoring 35, 36, 37, 38, 43
 - Humidity profile 39
- I**
- Installation site 18
 - Intended use 8
 - Interfaces 11
 - IP address 48
- K**
- Keysound 59
- L**
- Language selection 47
 - Loading the appliance 25
 - Log memory 45, 60
- M**
- Maintenance 63
 - Malfunctions 9, 41, 43
 - Manufacturer 2
 - Material 11
 - Mechanical temperature monitoring 34
 - Menu 46
 - Menu mode 46
 - Minimum clearances 18
 - Monitoring function 32
 - Monitoring temperature 32
- N**
- Nameplate 12
 - Network 12, 48
- O**
- O monitoring 38
 - Operating 23
 - Operating modes 27
 - Operating personnel 8
 - Operating problems 43
 - Operation 23
- P**
- Packaging material 17
 - Parameter adjustment 27, 47
 - Power failure 45
 - Power supply 20, 60
 - Product safety 6
 - Programme 58
 - Programme mode 27, 30
 - Protocol 60
 - Pt100 temperature sensor 32
 - Putting into operation 20
- R**
- Regular maintenance 63
 - Remote control 50
- S**
- Safety regulations 6, 10
 - Service 63
 - Servicing 63
 - Setting up 16, 18
 - Setup 48
 - Sound 52, 59
 - SOUND 59
 - Speaker symbol 32, 35, 37, 38, 41
 - Standards 14

- Starting a programme 30
 - Sterile filter 63
 - Sterilisation programme 39
 - Sterilisation programmes 8, 58, 59
 - Sterilising 39
 - Sterilizing the appliance 39
 - Storage after delivery 17
 - Switching off 40
 - Switching on 22
- T**
- TB 34
 - Technical data 13
 - Temperature 28
 - Temperature calibration 52
 - Temperature comparison 52
 - Temperature deviation 53
 - Temperature limiter 34
 - Temperature monitor 32, 33
 - Temperature monitoring 32
 - Temperature sensor 32
 - Tilt protection 19
 - Time 51
- Timer 29
 - Timer mode 50
 - Transport 16, 17
 - Transport damage 17
 - Turn control 27
 - TWW 32
 - TWW temperature monitoring 33
- U**
- Unit 49
 - Unpacking 17
 - USB interface 11, 60
 - USER ID 61
- W**
- Warning messages 11, 41
 - Water specifications 20
 - Water supply 20
 - Water tank 21
 - Water tray 20
 - Weight 13
 - What to do in case of accidents 9

memmert

CO₂ Incubator ICO

D33451 | Date 01/2022

englisch

Memmert GmbH + Co. KG
Postfach 1720 | D-91107 Schwabach
Tel. +49 9122 925-0 | Fax +49 9122 14585
E-Mail: sales@memmert.com
facebook.com/memmert.family