



**B-SAFETY**<sup>®</sup>  
PROFESSIONAL SAFETY SOLUTIONS

**DE** BEDIENUNGSANLEITUNG

**SV** BRUKSANVISNINGAR

**EN** OPERATING INSTRUCTIONS

**FI** KÄYTTÖOHJEET

**FR** MODE D'EMPLOI

**RU** РУКОВОДСТВО ПО ЭКСПЛУАТАЦИИ

**IT** ISTRUZIONI PER L'USO

**PL** INSTRUKCJA OBSŁUGI

**ES** INSTRUCCIONES DE OPERACIÓN

**CS** NÁVOD K OBSLUZE

**PT** MANUAL DE INSTRUÇÕES

**RO** INSTRUCȚIUNI DE OPERARE

**NL** BEDIENINGSINSTRUCIES

**HU** HASZNÁLATI UTASÍTÁS

**DA** BRUGSANVISNING

**ZH** 操作说明

**NO** BRUKSANVISNING

**JA** 操作方法

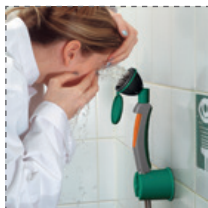

① DE ANWENDUNG EN APPLICATION FR UTILISATION IT APPLICAZIONE ES APLICACIÓN  
 PT APLICAÇÃO NL AANVRAAG DA ANSØGNING NO APPLIKASJON SV ANSÖKAN FI HAKEMUS  
 RU НАЗНАЧЕНИЕ PL APLIKACJA CS APLIKACE RO APLICAȚIE HU ALKALMAZÁS ZH 应用  
 JA アプリケーション



② DE HINWEISE EN NOTES FR INDICATIONS IT NOTE ES NOTAS PT NOTAS NL OPMERKINGEN  
 DA NOTER NO TIPS SV ANMÄRKNINGAR FI HUOMAUTUKSET RU ПОДСКАЗКИ PL UWAGI  
 CS POZNÁMKY RO NOTE HU MEGJEGYZÉSEK ZH 笔记 JA 備考

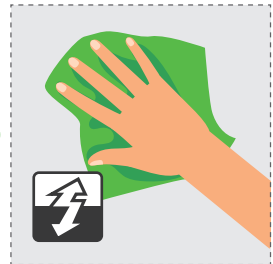
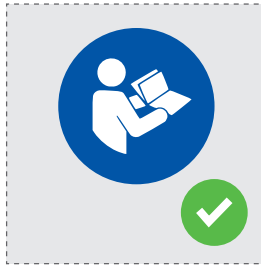

③ DE NORMEN EN STANDARDS FR NORMES IT NORME ES NORMAS PT NORMAS NL NORMEN  
 DA STANDARDER NO NORMER SV STANDARDER FI NORMIT RU НОРМЫ PL NORMY  
 CS STANDARDER RO APLICAȚIE HU NORMÁK ZH 标准 JA 規格



✓ EN 15154-2:2006  
 ✓ ANSI Z358.1-2014



④ DE BETRIEBSDRUCK EN OPERATING PRESSURE FR PRESSION DE SERVICE IT PRESSIONE D'ESERCIZIO  
 ES PRESIÓN DE FUNCIONAMIENTO PT PRESSÃO DE FUNCIONAMENTO NL BEDRIJFSDRUK DA DRIFTSTRYK  
 NO DRIFTSTRYKK SV ARBETSTRYCK FI KÄYTTÖPAINO RU РАБОЧЕЕ ДАВЛЕНИЕ PL CIŚNIENIE ROBOCZE  
 CS PROVOZNÍ TLAK RO PRESIUNEA DE FUNCȚIONARE HU ŰZEMI NYOMÁS ZH 操作压力 JA 作動压力

x1



☞ Min. 1.5 bar g  
 ☞ Max. 10 bar (PN10)

x2



☞ Min. 2.5 bar g  
 ☞ Max. 10 bar (PN10)

⑤ DE VOLUMENSTROM EN FLOW RATE FR DÉBIT VOLUMIQUE IT FLUSSO DI VOLUME ES FLUJO DE  
 VOLUMEN PT FLUXO DE VOLUME NL VOLUMESTROOM DA VOLUMENSTRØM NO VOLUMSTRØM  
 SV VOLYMFLÖDE FI TILAVUUSVIRTA RU ВОЛУМЕНСТРОМ PL PRZEPŁYW OBJĘTOŚCIOWY  
 CS OBJEMOVÝ TOK RO FLUXUL DE VOLUM HU TÉRFOGATÁRAM ZH 体积流量 JA ホリユームフロー

x1



☞ Min. 1.5 bar g  
 ☞ 7 L / min.

x2



☞ Min. 2.5 bar g  
 ☞ 14 L / min.

⑥ DE WASSERVERSORGUNG EN WATER SUPPLY FR ALIMENTATION EN EAU IT FORNITURA D'ACQUA  
 ES SUMINISTRO DE AGUA PT ABASTECIMENTO DE ÁGUA NL WATERVOORZIENING DA VANDFORSYNING  
 NO VANNTILFØRSEL SV VATTENFÖRSÖRJNING FI VESIHUOLTO RU ПОДАЧА ВОДЫ PL ZAOPATRZENIE  
 W WODĘ CS ZÁSOBOVÁNÍ VODOU RO ALIMENTAREA CU APĂ HU VÍZELLÁTÁS ZH 供水 JA 水の供給



- ✓ DIN 1988
- ✓ EN 1717



- ⓘ B-SAFETY: 20°C – 25°C
- ⓘ EN 15154-2:2006:  
15°C – 37°C
- ⓘ ANSI Z358.1-2014:  
16°C – 38°C



- ⓘ EN 15154-2:2006:  
Min. 15 min.
- ⓘ ANSI Z358.1-2014:  
Min. 15 min.

⑦ DE STANDORT EN LOCATION FR EMPLACEMENT IT POSIZIONE ES UBICACIÓN PT LOCALIZAÇÃO  
 NL LOCATIE DA PLACERING NO PLASSERING SV PLATS FI SIJAINTI RU МЕСТО РАСПОЛОЖЕНИЯ  
 PL LOKALIZACJA CS UMÍSTĚNÍ RO LOCAȚIE HU HELYSZÍN ZH 地点 JA 所在地

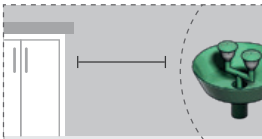

- ✓ EN 15154-2:2006:  
Min. 15 cm
- ✓ ANSI Z358.1-2014:  
Min. 15,3 cm / 6 inch

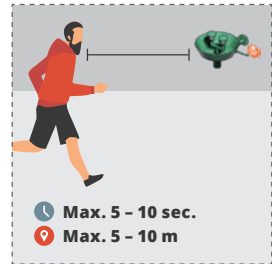

- ⓘ Max. 5 – 10 sec.
- ⓘ Max. 5 – 10 m



- ✓ EN 15154-2:2006:  
80 – 120 cm

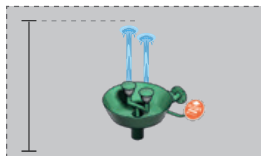

- ✓ ANSI Z358.1-2014:  
83,8 – 134,6 cm  
(33 – 53 in.)

⑧ DE INSTALLATION EN INSTALLATION FR INSTALLATION IT INSTALLAZIONE ES INSTALACIÓN  
 PT INSTALAÇÃO NL INSTALLATIE DA INSTALLATION NO INSTALLASJON SV INSTALLATION  
 FI ASENNUS RU МЕСТО И ВЫСОТА УСТАНОВКИ PL INSTALACJA CS INSTALACE RO INSTALARE  
 HU TELEPÍTÉS ZH 安装 JA インストール

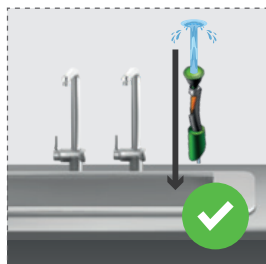
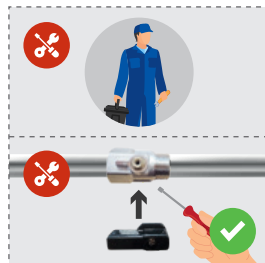
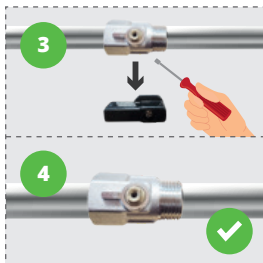
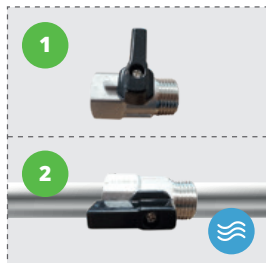

⑨ DE KENNZEICHNUNG EN LABELLING FR MARQUAGE IT MARCATURA ES MARCADO  
 PT MARCAÇÃO NL MARKERING DA MÆRKNING NO MERKING SV MÅRKNING FI MERKINTÄ  
 RU МАРКИРОВКА PL ZNAKOWANIE CS OZNAČOVÁNÍ RO MARCARE HU JELÖLÉS ZH 标记  
 JA マーキング

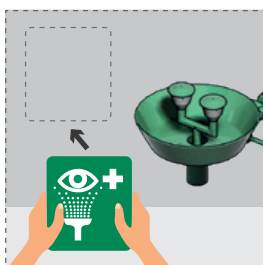

**10 DE BETRIEB EN OPERATION FR SERVICE IT OPERAZIONE ES OPERACIÓN PT OPERAÇÃO**  
**NL OPERATIE DA OPERATION NO VIRKSOMHET SV OPERATION FI OPERAATIO**  
**RU ПРЕДУПРЕЖДАЮЩАЯ МАРКИРОВКА PL OPERACJA CS OPERACE RO OPERAȚIUNEA**  
**HU MŰVELET ZH 运作 JA 操作方法**

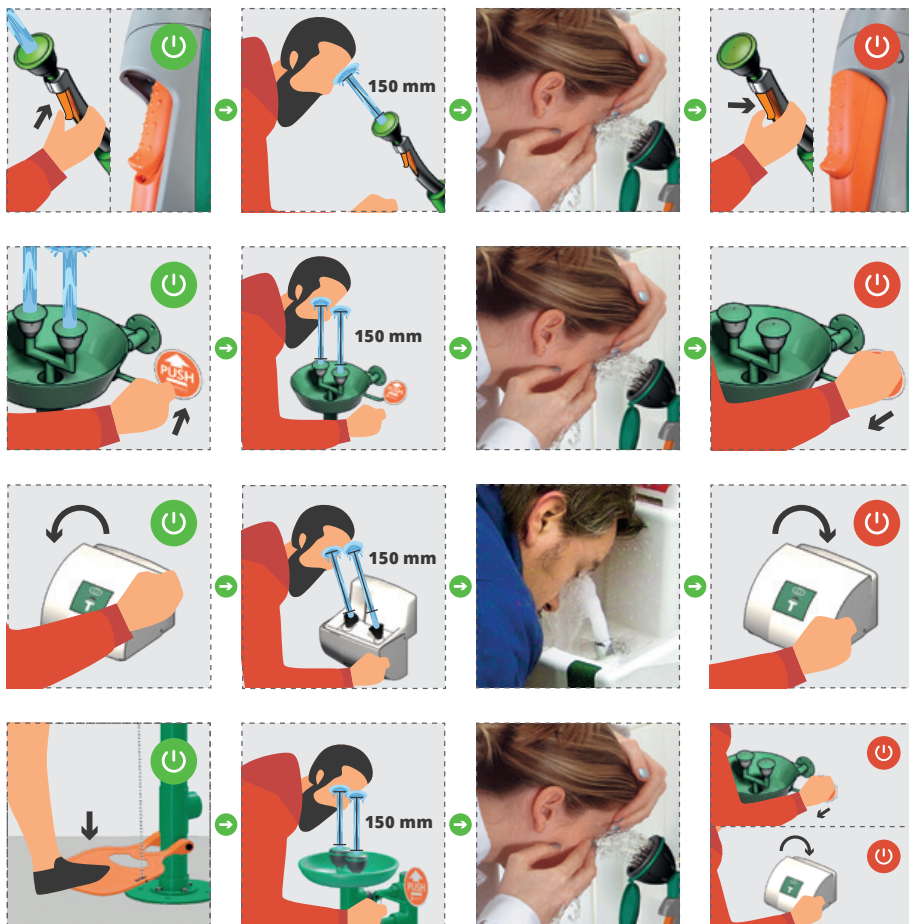

11 DE UNFALLVERHÜTUNG EN ACCIDENT PREVENTION FR PRÉVENTION D'ACCIDENTS IT PREVENZIONE DEGLI INCIDENTI ES PREVENCIÓN DE ACCIDENTES PT PREVENÇÃO DE ACIDENTES NL PREVENTIE VAN ONGEVALLLEN DA FOREBYGGELSE AF ULYKKER NO ULYKKESFOREBYGGING SV FÖREBYGGANDE AV OLYCKOR FI ONNETTOMUUKSIEN ENKÄISY RU ЭКСПЛУАТАЦИЯ PL ZAPOBIEGANIE WYPADKOM CS PREVENCE NEHOD RO PREVENIREA ACCIDENTELOR HU BALESETMEGELŐZÉS ZH 事故预防 JA 事故防止

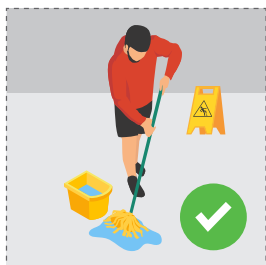

12 DE WARTUNG EN MAINTENANCE FR MAINTENANCE IT MANUTENZIONE ES MANTENIMIENTO PT MANUTENÇÃO NL ONDERHOUD DA VEDLIGEHODELSE NO VEDLIKEHOLD SV UNDERHÅLL FI HUOLTO RU ТЕХНИЧЕСКОЕ ОБСЛУЖИВАНИЕ И УХОД PL KONSERWACJA CS ÚDRŽBA RO ÎNTREȚINERE HU KARBANTARTÁS ZH 维护 JA メンテナンス

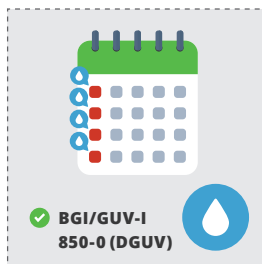

13 DE STÖRUNG EN FAULTS FR DÉFAUTS IT MALFUNZIONAMENTO ES MAL FUNCIONAMIENTO  
 PT MAU FUNCIONAMENTO NL STORING DA FUNKTIONSFEJL NO UORDEN SV FUNKTIONSTÖRNING  
 FI TOIMINTAHÄIRIÖ RU НЕПОЛАДКИ PL NIEPRAWIDŁOWE DZIAŁANIE CS PORUCHA RO DEFECTIUNE  
 HU ÜZEMZAVAR ZH 运作故障 JA 誤動作

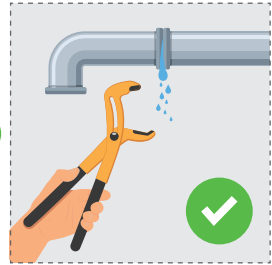
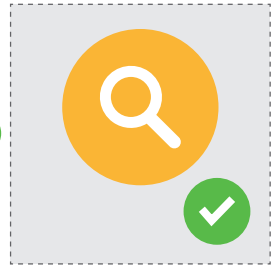

14 DE ENTSORGUNG EN DISPOSAL FR ÉLIMINATION IT SMALTIMENTO ES ELIMINACIÓN  
 PT ELIMINAÇÃO NL VERWIJDERING DA BORTSKAFFELSE NO AVHENDING SV BORTSKAFFANDE  
 FI HÄVITTÄMINEN RU УТИЛИЗАЦИЯ PL USUWANIE CS LIKVIDACE RO ELIMINARE HU ELTÁVOLÍTÁS  
 ZH 废弃处理 JA 廃棄

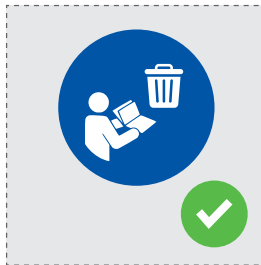
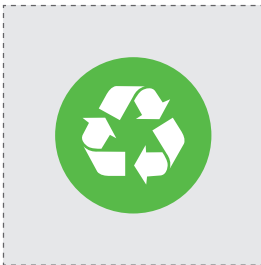



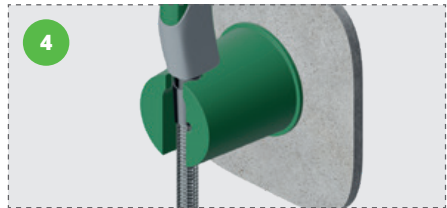
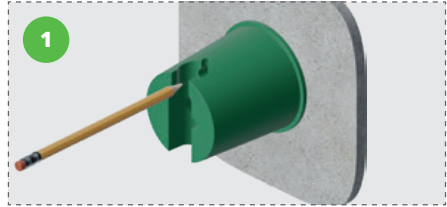

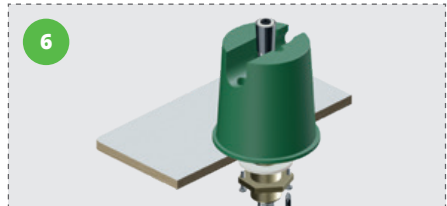
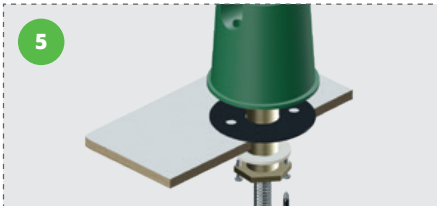
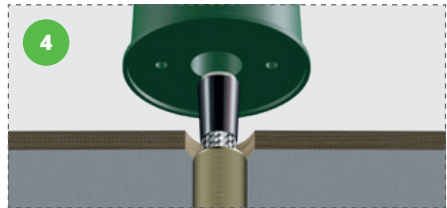
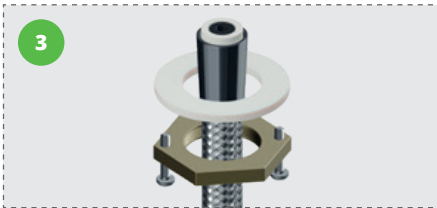
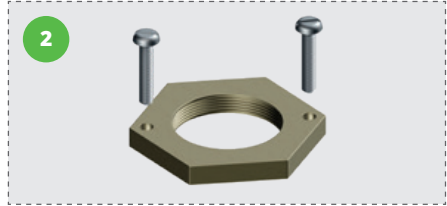
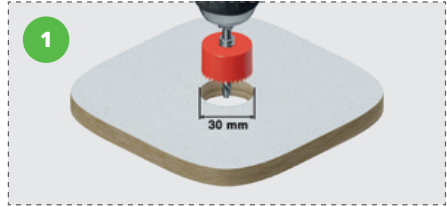
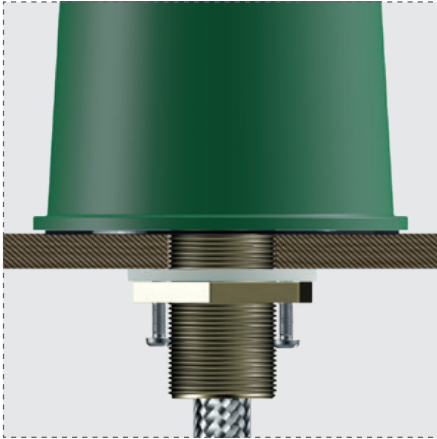

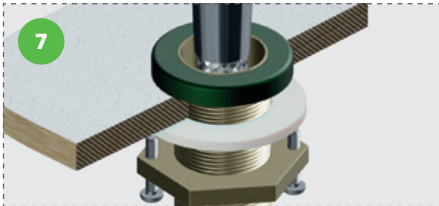
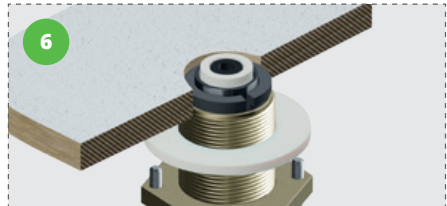
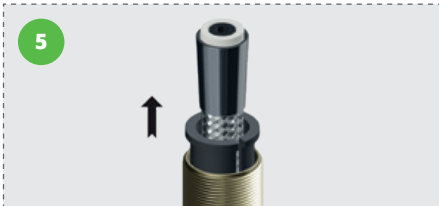
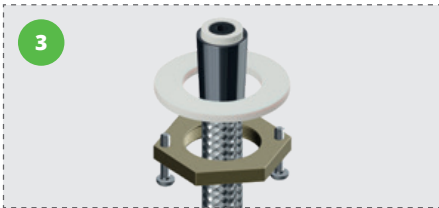
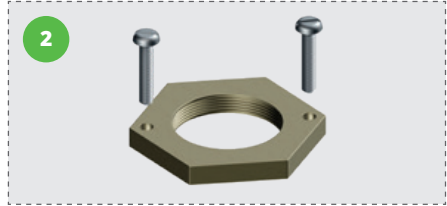
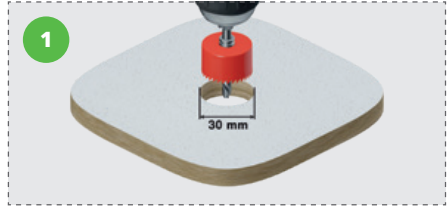
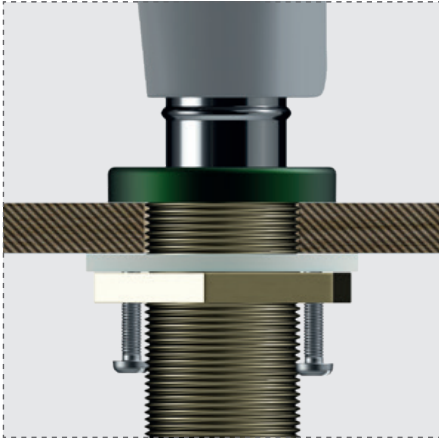

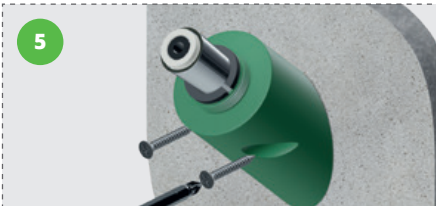
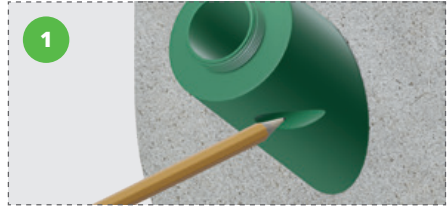
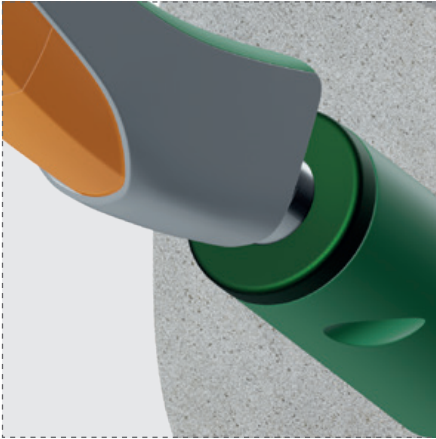

## BR 200 0X5

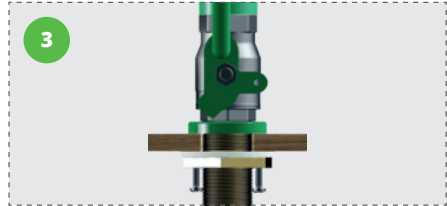
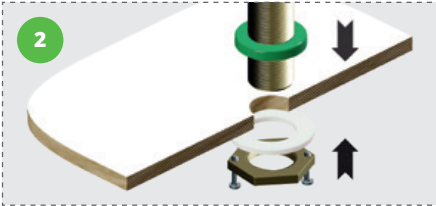
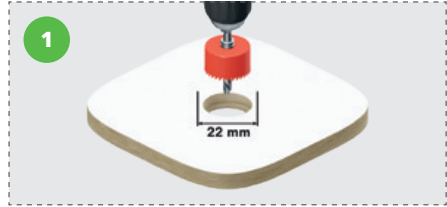

## BR 210 0X5

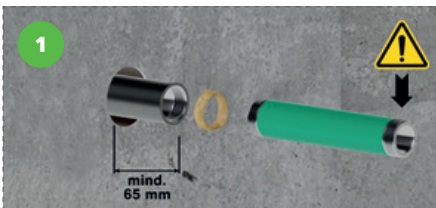

BR 210 0X5 + BR 861 XXX



BR 210 0X5 + BR 832 XXX

## BR 250 XX5

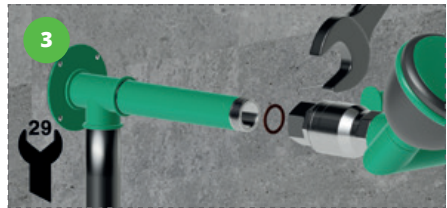
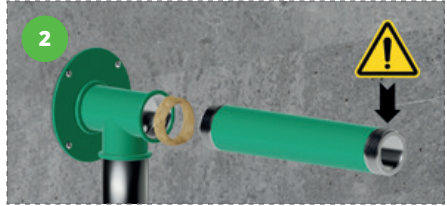
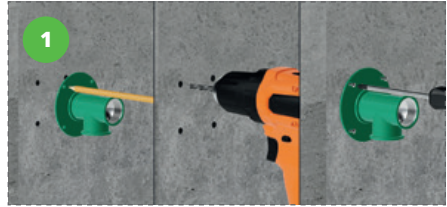

BR 250 4X5

## BR 300 XX5

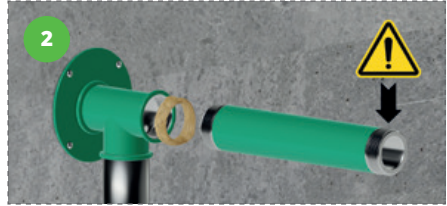
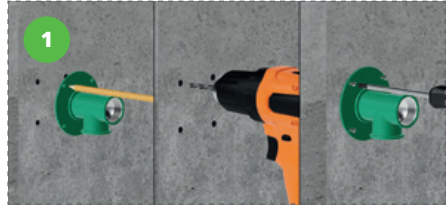

BR 300 4X5



BR 300 1X5 + BR 305 XX5



BR 300 1X5 + BR 867 XX5



BR 300 1X5 + BR 837 XX5





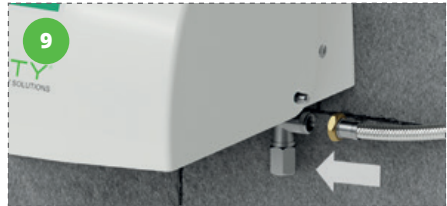
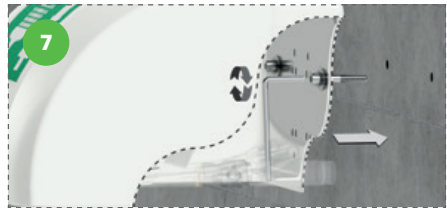
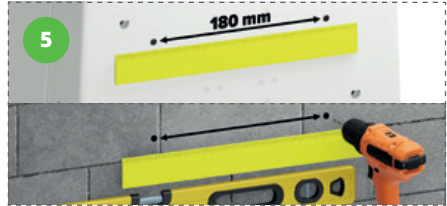

# BR 850 005



BR 850 005 + BR 868 XXX

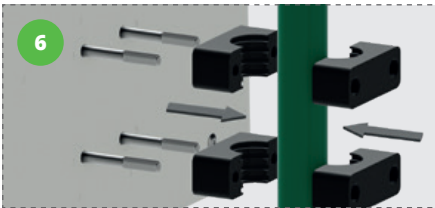
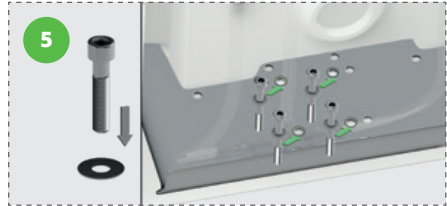

# BR 850 005

