

## Operating instructions

Alpha

Immersion Thermostat

A

Heating Thermostats

A 6, A 12, A 24

Cooling Thermostats

RA 8, RA 12, RA 24

Read the instructions prior to performing any task!

Manufacturer  
LAUDA DR. R. WOBSE GMBH & CO. KG  
Laudaplatz 1  
97922 Lauda-Königshofen  
Germany  
Telephone: +49 (0)9343 503-0  
Fax: +49 (0)9343 503-222  
E-mail [info@lauda.de](mailto:info@lauda.de)  
Internet <http://www.lauda.de>  
Q4WA-E\_13-004-EN English  
Translation of the original operating instructions

Release 7/2022 M  
replaces release 12/2022 L, 09/2020j, 08/2020i

## Prefixed safety notes



Before operating the equipment please read carefully all the instructions and safety notes. If you have any questions please phone us!

Follow the instructions on setting up, operation etc. This is the only way to avoid incorrect operation of the equipment and to ensure full warranty protection.

- Transport the equipment with care!  
Cooling thermostats may NEVER be overturned nor put upside down!
- Equipment and its internal parts can be damaged:
  - by dropping,
  - by shock.
- Equipment must be operated only by technically qualified personnel!
- Never operate the equipment without a proper heat transfer liquid!
- Never operate the equipment without sufficient water or heat transfer liquid level!
- Do not start up the equipment, if:
  - it is damaged or leaking,
  - the supply cable is damaged.
- Switch off the equipment and pull out the mains plug for:
  - servicing or repair,
  - before moving the equipment!
- Drain the bath before moving the equipment!
- Have the equipment serviced or repaired by properly qualified personnel only!
- The device may only be used in the following areas:
  - Production, quality assurance, research and development in an industrial environment.



The Operating Instructions include additional safety notes which are identified by a triangle with an exclamation mark. Carefully read the instructions and follow them accurately! Disregarding the instructions may have serious consequences, such as damage to the equipment, damage to property or injury to personnel.

*Product specifications are subject to change without notice!*

## Table of content

	<i>Prefixed safety notes</i> .....	3
<b>1</b>	<b>SAFETY NOTES</b> .....	<b>6</b>
1.1	GENERAL SAFETY NOTES .....	6
1.2	OTHER SAFETY NOTES .....	7
<b>2</b>	<b>BRIEF OPERATING INSTRUCTIONS</b> .....	<b>8</b>
<b>3</b>	<b>CONTROL AND FUNCTIONAL ELEMENTS</b> .....	<b>10</b>
<b>4</b>	<b>UNIT DESCRIPTION</b> .....	<b>15</b>
4.1	ENVIRONMENTAL CONDITIONS.....	15
4.2	TYPES OF UNIT .....	15
4.3	BATHS .....	15
4.4	PUMP .....	15
4.5	MATERIALS.....	16
4.6	TEMPERATURE INDICATION, CONTROL AND SAFETY CIRCUIT .....	16
4.7	REFRIGERATION SYSTEM .....	16
4.8	STANDARD ACCESSORIES.....	16
<b>5</b>	<b>UNPACKING</b> .....	<b>17</b>
<b>6</b>	<b>PREPARATIONS</b> .....	<b>18</b>
6.1	ASSEMBLY AND SETTING UP.....	18
6.2	FILLING AND EMPTYING.....	21
6.3	HEAT TRANSFER LIQUIDS AND HOSES .....	22
6.4	CONNECTION OF EXTERNAL CIRCUITS.....	24
<b>7</b>	<b>STARTING UP</b> .....	<b>25</b>
7.1	CONNECTION TO THE SUPPLY .....	25
7.2	SWITCHING ON.....	25
7.3	GENERAL KEY FUNCTIONS AND PILOT LAMPS.....	26
7.4	TEMPERATURE SETPOINT SETTING <i>SEP</i> .....	27
7.5	AUTOMATIC SHUTDOWN TIMER <i>ASC</i> .....	27
7.6	DEFINING TEMPERATURE LIMITS <i>HF</i> AND <i>LJ</i> .....	28
7.7	REFRIGERATION UNIT SUBMENU <i>RUJL</i> .....	28
7.8	OFFSET FOR THE INTERNAL TEMPERATURE PROBE <i>IRL</i> .....	29
7.9	RESTORING WORKS SETTINGS <i>REF</i> .....	29
7.10	STANDBY <i>SPRY</i> .....	30
7.11	SAFETY FUNCTIONS .....	30
	7.11.1 <i>Safety functions and removal</i> .....	30
	7.11.2 <i>Overtemperature and low level protection</i> .....	31
	7.11.3 <i>Overtemperature and low level protection testing</i> .....	31

7.11.4	Unlock the overtemperature protection .....	32
7.11.5	Pump-motor supervision: Overload .....	32
7.11.6	Fault list "Alarms and Errors" .....	33
<b>8</b>	<b>MAINTENANCE</b> .....	<b>34</b>
8.1	CLEANING.....	34
8.2	MAINTENANCE .....	34
8.2.1	Service intervals.....	34
8.2.2	Testing the heat transfer liquid .....	35
8.2.3	Maintenance of the refrigeration unit.....	35
8.3	NOTE ON REPAIR.....	35
8.4	DISPOSAL INFORMATION .....	35
8.4.1	Disposal of refrigerant.....	35
8.4.2	Disposal of packaging.....	35
8.5	ORDERING SPARES AND RATING LABEL.....	36
<b>9</b>	<b>ACCESSORIES</b> .....	<b>37</b>
<b>10</b>	<b>TECHNICAL DATA AND DIAGRAMS</b> .....	<b>39</b>
<b>11</b>	<b>DECLARATION OF CONFORMITY AND PRODUCT RETURNS</b> .....	<b>45</b>
<b>12</b>	<b>COPYRIGHT</b> .....	<b>48</b>
<b>13</b>	<b>INDEX</b> .....	<b>49</b>

Explanation of symbols		
	<b>Caution</b>	This sign is used where there may be injury to personnel if a recommendation is not followed accurately or is disregarded.
	<b>Note</b>	Here special attention is drawn to some aspect. May include reference to danger.
	<b>Reference</b>	Refers to other information in different sections.

# 1 Safety notes

## 1.1 General safety notes

The units are designed for operation with non-flammable liquids to DIN EN 61010-2-010.

A laboratory thermostat is intended for heating, cooling and pumping liquids according to the needs of the user. This leads to hazards by high or low temperatures, fire, and the general hazards due to the application of electrical energy.

The user is largely protected through the application of the appropriate standard specifications.

Further hazard sources may arise from the type of material being thermostated, for example by exceeding or undercutting certain temperature thresholds or by the fracture of the container and reaction with the heat transfer liquid.

It is not possible to cover all possibilities; they remain largely within the responsibility and the judgement of the operator.

The unit must only be used as intended and as described in these Operating Instructions. This includes operation by suitably instructed qualified personnel.

The units are not designed for use under medical conditions according to DIN EN 60601-1 or IEC 601-1!

Classification in accordance with EMC requirements			
Unit	Immunity requirements	Emissions class	Customer power supply
Heating and cooling thermostats Alpha	Table 1 in accordance with DIN EN 61326-1	Emissions Class B in accordance with CISPR 11	Only for EU Domestic connection value $\geq$ 100 A
	Table 1 in accordance with DIN EN 61326-1	Emissions Class B in accordance with CISPR 11	Rest of the world (outside EU) No limitation

### Valid for the USA:

Instructions for Class A digital devices

“This equipment has been tested and found to comply with the limits for Class A digital device, pursuant to Part 15 of the FCC (Federal Communication Commission) Rules. These limits are designed to provide reasonable protection against harmful interference when the equipment is operated in a commercial environment. This equipment generates, uses, and can radiate radio frequency energy and, if not installed and used in accordance with the instruction manual, may cause harmful interference to radio communications. Operation of this equipment in a residential area is likely to cause harmful interference in which case the user will be required to correct the interference at his own expense.”

“This device complies with Part 15 of the FCC (Federal Communication Commission) Rules. Operation is subject to the following two conditions: (1) This device may not cause harmful interference, and (2) this device must accept any interference received, including interference that may cause undesired operation.”

### Valid for Canada:

“This Class A digital apparatus complies with Canadian ICES-003” (ICES = Interference Causing Equipment Standards).

«Cet appareil numérique de la classe A est conforme à la norme NMB-003 du Canada».

## 1.2 Other safety notes

- Check the device carefully for shipping damage before putting into operation. Never start a damaged device!
- Only technically qualified personnel must operate the equipment!
- Connect the unit only to grounded mains power (PE).
- Parts of bath covers (types Alpha RA xx) may reach surface temperatures above 70 °C when operating at higher temperatures. Take care when touching the device! → Danger of burns!
- Use suitable hoses (⇒ 6.3).
- Protect tubing with hose clips against slipping off. Avoid kinks in the hoses!
- Check hoses from time to time for possible material defects!
- Heat transfer hoses and other hot parts must not come into contact with the supply cable!
- When using the thermostat as circulation thermostat, failure of hoses may lead to leaking of hot heat transfer liquid and become a danger to personnel and objects.
- When no external consumer is connected to the thermostat the pump outflow must be linked to the return!
- The units are designed for operation with non-flammable liquids to DIN EN 61010-2-010 only.
- Depending on the heat transfer liquid used and the mode of operation it is possible for irritating vapours to be produced. Ensure appropriate ventilation!
- Always pull out the mains plug before cleaning, maintenance or moving the thermostat!
- Repairs on the control unit and/or the refrigeration system must be carried out by properly qualified personnel only.
- Values for temperature control and indicating accuracy apply under normal conditions according to DIN 12876. High-frequency electromagnetic fields may under special conditions lead to unfavourable values. This does not affect the safety!

## 2 Brief operating instructions



This brief instruction shall give you the possibility to operate the unit quickly. For safe operation of the unit it is absolutely necessary to read all the instructions and safety notes carefully!

1. Assemble unit and add items as appropriate (⇒ 6).
2. Fill the unit with corresponding heat transfer liquid.  
When starting up the unit, the tubular heater (⇒ 3) has to be covered with liquid! (⇒ 6.2).

Heating and immersion thermostats:

Fill the bath with decalcified water (⇒ 6.3).

Cooling thermostats:

Fill the bath with proper glycol/water mixture (⇒ 6.3).

The units are designed only for operation with non-flammable liquids to DIN EN 61010-2-010.

→ Take care of the level of the heat transfer liquid! (⇒ 6.2).

3. Connect the unit only to a socket with a protective earth (PE) connection.  
Compare the information on the rating label with the supply details.

4.



Switch the unit on with the front switch .

5. Now the display shows the current bath temperature, for example

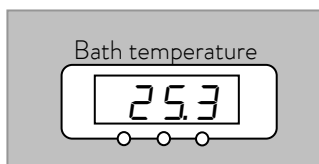

On warning or error message refer section (⇒ 7.11).



The overtemperature cut-out point **SAFE** is fixed at 105 °C and cannot be changed.  
However, you can adjust a minimum and maximum operation temperature of the thermostat (⇒ 7.6).



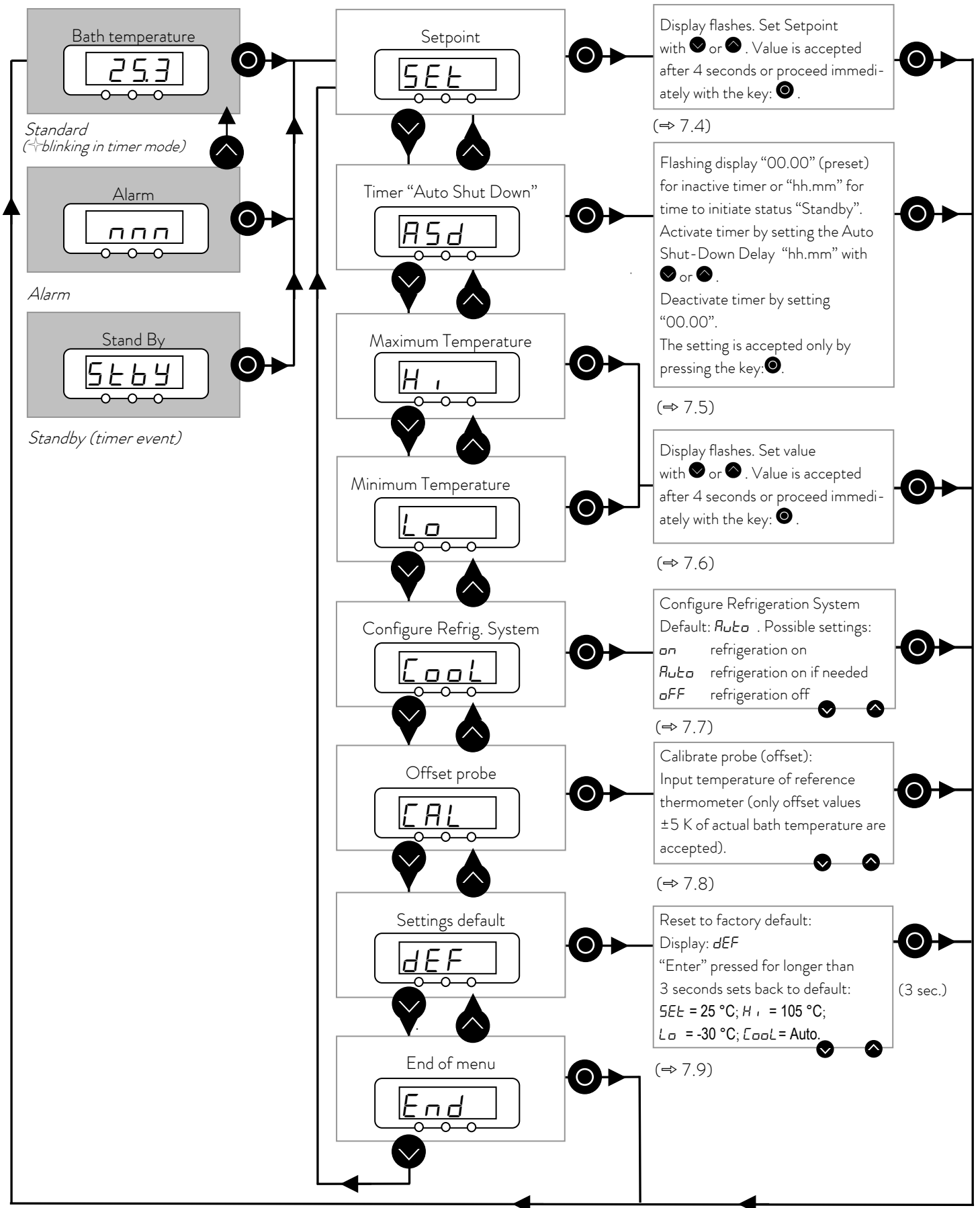

### 3 Control and functional elements

#### Alpha immersion thermostat

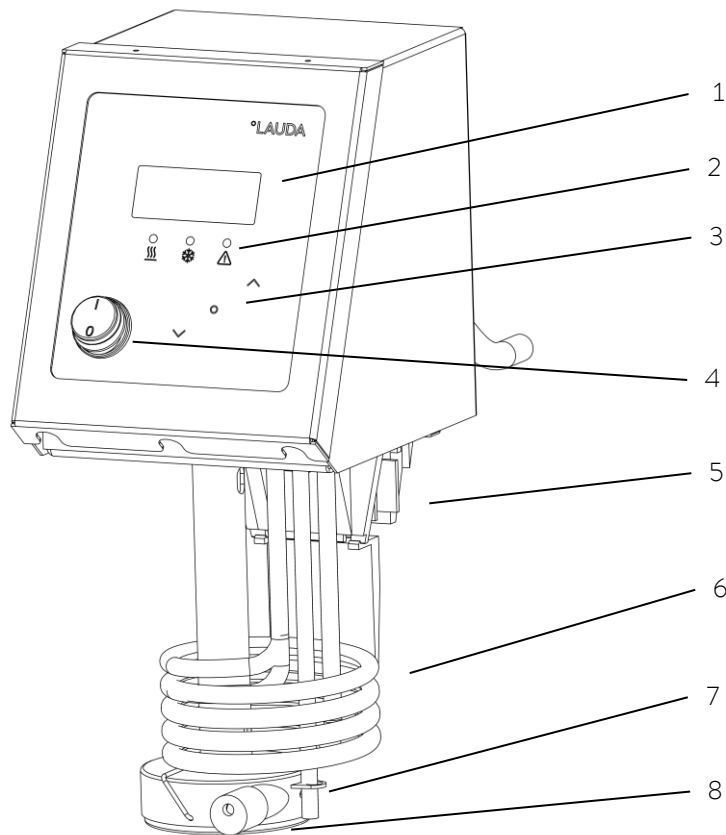

- 1 Temperature controller with four segment LED display
- 2 Heater active (yellow LED is lit)  
Cooler active (blue LED is lit)  
Error signal (red LED is flashing)
- 3 Menu functions, select and Enter keys
- 4 Mains switch
- 5 Screw clamp
- 6 Tubular heater
- 7 Temperature probe Pt100
- 8 Pump outflow with pump outflow reducer

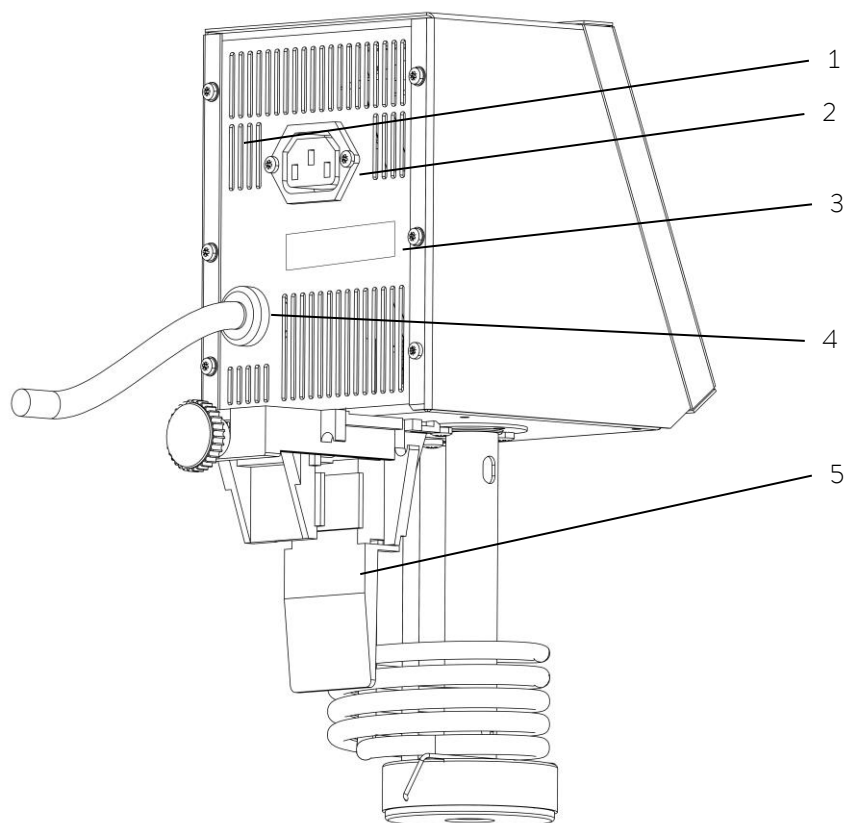

- 1 Reset button (press only if the display shows *SAFE* )
- 2 Cooler cable
- 3 Rating label
- 4 Mains cable
- 5 Screw clamp

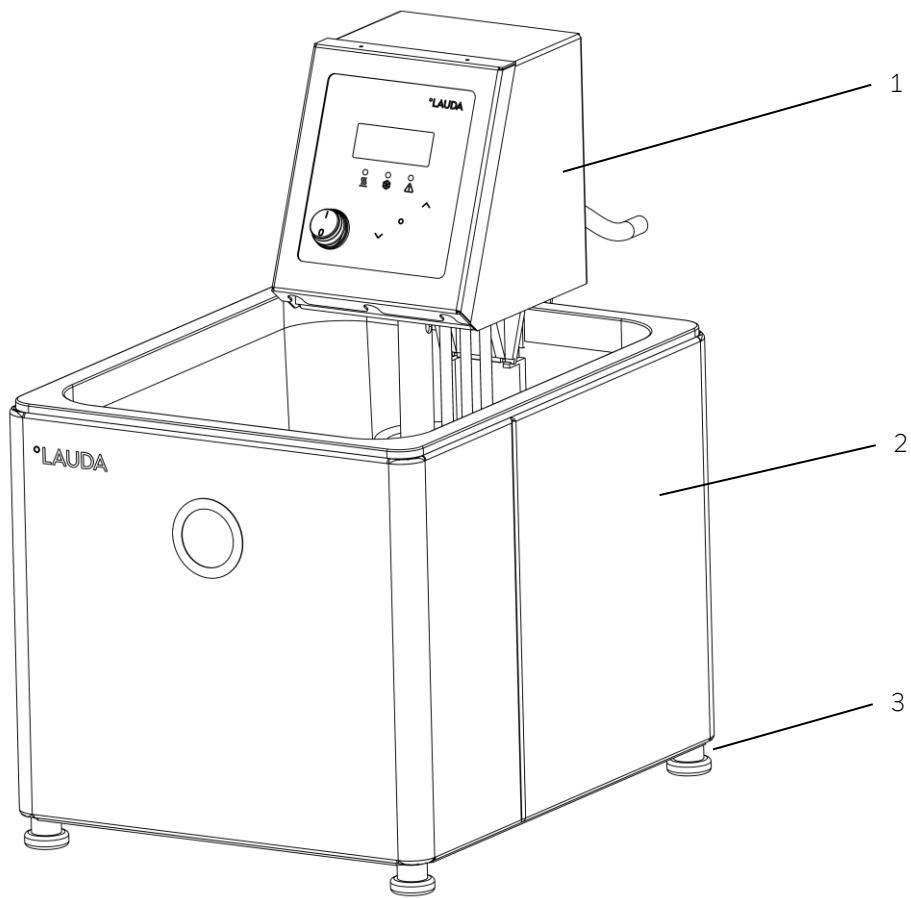

- 1 Control head with clamp
- 2 Bath vessel
- 3 Four mounting feet

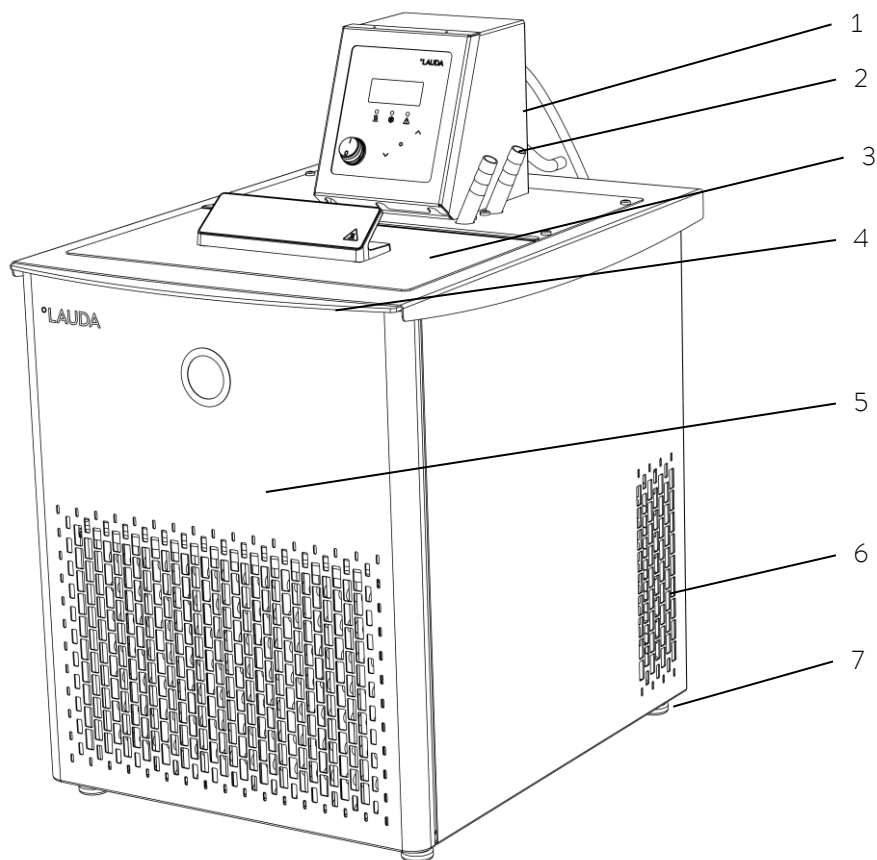

- 1 Control head
- 2 Pump connections: return to bath and pump outflow
- 3 Bath cover
- 4 Handle on front and back
- 5 Removable front cover
- 6 Grille on both sides
- 7 Four mounting feet

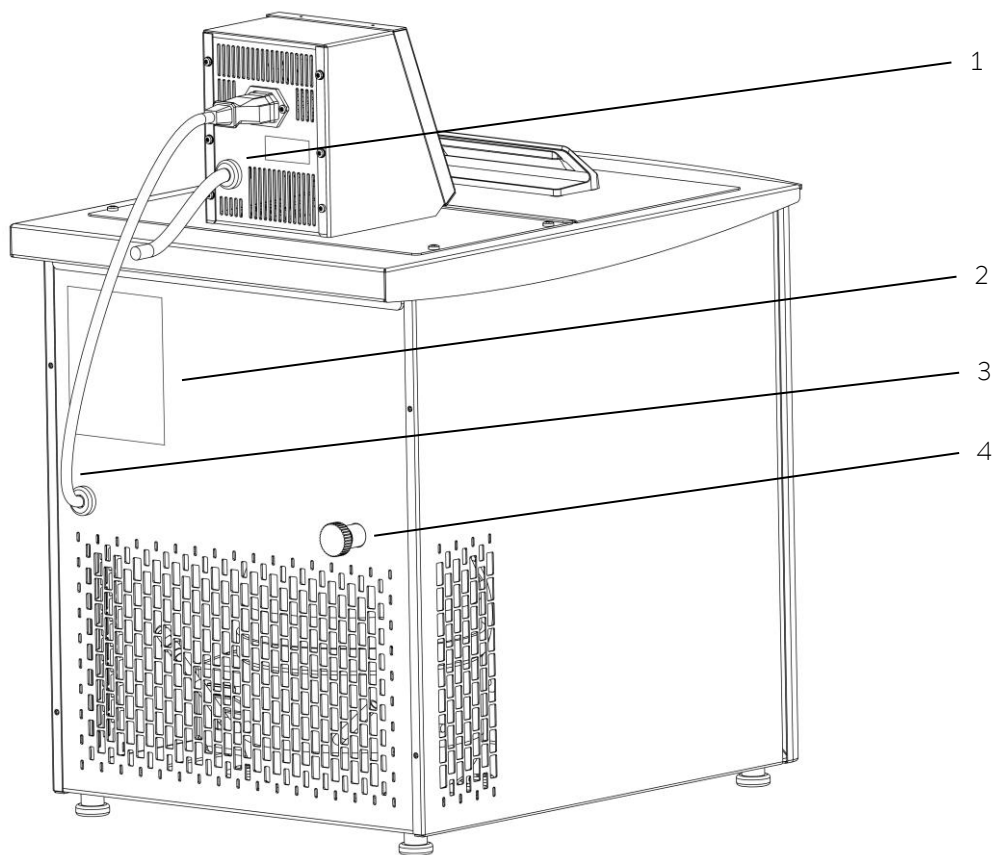

- 1 Mains cable
- 2 Rating label
- 3 Cooler cable
- 4 Bath drain nozzle

## 4 Unit description

### 4.1 Environmental conditions

The operation of the thermostats is only allowed under the following conditions as specified in DIN EN 61010-1 and DIN EN 61010-2-010:

- Indoor use, no outdoor installation.
- Operation of the device up to an altitude of 2000 m above sea level.
- Foundation must be dense, even, non-slippery and non-flammable.
- Keep clear distance (⇒ 6.1).
- Ambient temperature range (⇒ 10).  
Use only within this range for an undisturbed operation.
- Mains supply voltage fluctuations (⇒ 10).
- Relative humidity (⇒ 10).
- Transient over voltage according to Installation Categories (Over voltage Categories) II.
- Pollution degree: 2.

### 4.2 Types of unit

The type designation of the Alpha thermostats consists of the letter A or RA (R for identification as low-temperature unit = cooling thermostat).

The immersion thermostat Alpha (control head) and the type of bath or the refrigeration system respectively.

Examples:

- RA 8 = Immersion thermostat Alpha (control head) and refrigeration system with bath of 8 liters maximum volume.
- A 12 = Control unit Alpha with bath of 12 liters maximum volume.

### 4.3 Baths

All units -except the immersion thermostat- provide a stainless steel bath. The last two digits of the model no. correspond to the approximate total volume in liter (for example bath RA 24 = approximately 24 liters).

Part of this volume may be used to insert objects. Be precautionary to overflow when inserting large volume samples!

For the immersion thermostat the bath volume is limited to 50 liters. The bath has to provide a reliable option to fix the thermostat clamp (wall thickness 10 – 30 mm).

### 4.4 Pump

All units are equipped with a centrifugal immersion pump. The pumps are driven by a shaded pole motor.

The pump outflow connection can be closed without causing any damage to the pump.

The pump flow can be reduced by the pump outflow reducer.

Pump characteristics (⇒ 10 Technical data).

## 4.5 Materials

All parts being exposed to the heat transfer liquid are made of high quality material appropriate to the operating temperature. Non-rusting stainless steel and high quality temperature-resistant materials are being used.

## 4.6 Temperature indication, control and safety circuit

The units are equipped with a 4-character LED display, which is used for the display of the measurements and settings, as well as the operating status. The entry of setpoints and other settings occurs under menu guidance via three keys.

With low level, overtemperature or other alarms the unit switches off the heater on all poles. The pump and the refrigerating machine are also switched off. Unlocking the protection system (⇒ 7.11.2).

A Pt100 temperature probe detects the outflow temperature in the bath. A high-resolution A/D converter processes the measurement. Further measurement conditioning occurs using a special control algorithm for controlling the heater actuator and the refrigeration system.

## 4.7 Refrigeration system

The refrigeration system consists essentially of a hermetically sealed compressor. Heat of condensation and motor heat are dissipated by a fan-cooled finned condenser. Fresh air is drawn in at the front of the unit; warmed air is discharged at the back and to the sides. The ventilation openings must not be restricted in order to ensure proper air circulation.

The compressors are fitted with sensors that responds both to the compressor temperature and to the motor current.

Cooling curves (⇒ 10 Technical data).

## 4.8 Standard accessories

All refrigerated RA types are delivered with bath covers and an external circulation set to connect an external circuit.

All heating types A 6, A 12 and A 24 are not supplied with bath covers. Cooling coil, bath cover and external circulation set can be ordered as accessory (⇒ 9).

A pump outflow reducer avoids to spill over liquid in small baths (A 6, RA 8, A 12, RA 12).



## 5 Unpacking

After the unit and accessories have been unpacked they have to be examined for potential transport damages. If there is any damage visible on the unit, a claim must be filled in writing with the freight forwarder (expeditor); a notification to the freight forwarder (expeditor) is obligatory so that the shipment can be examined. Please also inform the LAUDA Service (⇒ 8.5).

Standard accessories:

Catalogue No.	Quantity	Designation	
Q4WA-E_13-004-EN	1x	Operating instructions	for all thermostats
UD 425	1x	Screw clamp	for immersion and for heating thermostats
---	2x	Pump outflow reducer with different hole sizes (diameter Ø 4.5 or Ø 6.0)	for all thermostats
---	1x	Bath cover	RA (cooling) types only
---	1x	External circulation set	RA (cooling) types only
---	1x	Silicone tube outlet to inlet (pump connection link)	RA (cooling) types only
EZB 260		Warning label "HOT surface" 	for all thermostats

## 6 Preparations

### 6.1 Assembly and Setting Up



Do not connect with power mains before assembly and setup is complete!!

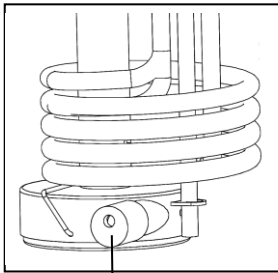

R

Place the unit on a flat surface. If necessary, attach the appropriate pump outflow reducer **R** onto the pump nozzle. In small baths use the pressure reducer to prevent any splashing of heat transfer liquid.

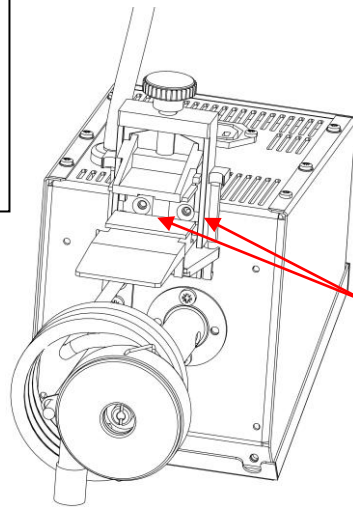

*Immersion/Heating thermostats only:*

Fix the clamp at the bottom of the control head by two screws M4 x 6 A3 (1.4541) ISO 7046 (recessed countersunk flat heads).

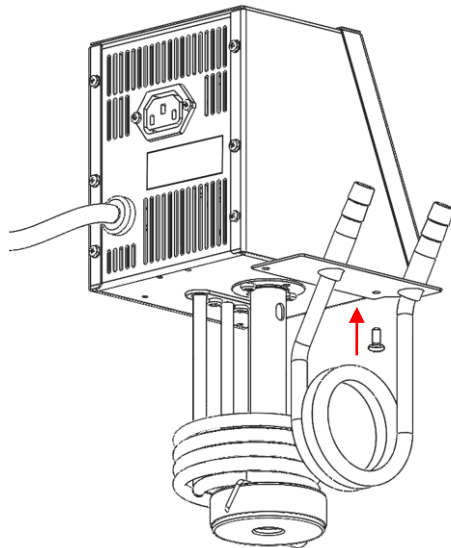

*Accessory "cooling coil set":*

Fix the cooling coil set at the bottom of the control head by means of the two screws (pan head with cross recess). The cooling coil set belongs to the left side of the head.

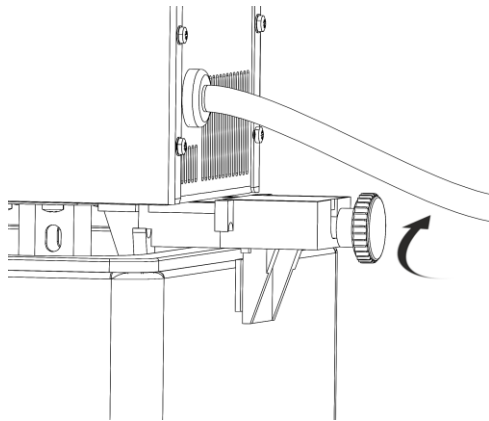

Carefully attach the immersion thermostat to prevent it dropping into the bath.

If this should occur during operation, never reach into the bath! Withdraw the mains plug immediately!

- Hang the thermostat into the bath and fix the clamp with the knurled screw on the edging of the bath.
- The wall thickness has to be 10 – 30 mm.
- Check for tight fitting!

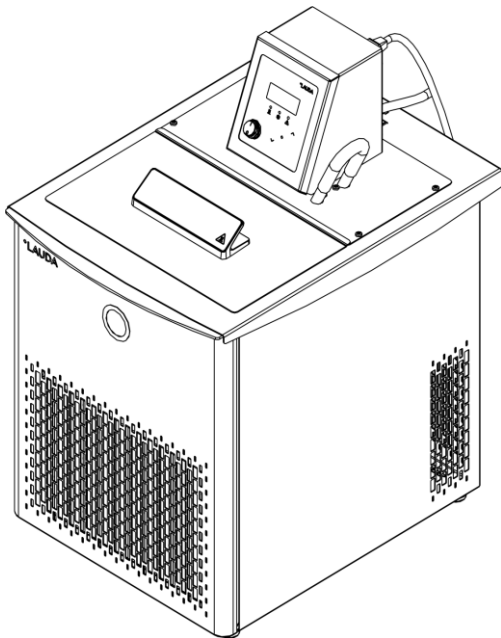

*Cooling thermostats only*

NEVER overturn the unit and never put it upside down!

After transport and before starting up, store it standing in upright position for two hours if possible.

Do not cover the ventilation openings.

Keep clear distance of at least 40 cm.



Pump connection link (silicone rubber)

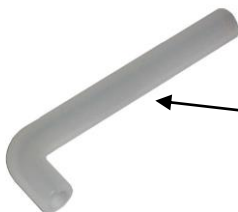

Remove the silicone L-tube at the pump housing to improve the circulation in the bath (only for operation without external consumer).

L-tube (silicone rubber)

Operation with external consumer  
(circulation thermostat (⇒ 6.4))



- When operating as bath thermostat without external consumer the pump outflow connection has to be linked to the return. At bath temperature above 70 °C the label “HOT surface” supplied must be affixed on the bath at clearly visible position!



- The unit can be operated safely up to an ambient temperature of 40 °C.
- Depending on the loading of the refrigeration system, a temporary shut-off can occur, especially in case of an ambient temperature of over 35 °C.
- Additionally a higher ambient temperature results in less refrigerating capacity.
- When starting up the refrigeration system after a longer time, it can take up to 30 minutes, depending on the ambient temperature and the unit type, until the nominal refrigerating capacity is reached.

## 6.2 Filling and Emptying

### Filling

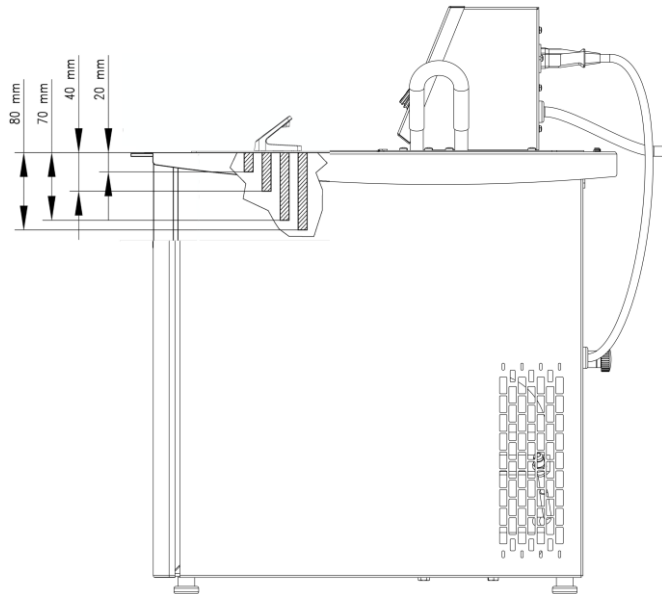

- Close the drain nozzle.
- Fill baths up to a maximum level of 20 mm below the bath bridge.
- Optimum operation at 20 – 40 mm below the bath bridge.
- Operation is possible down to 70 mm below the bath bridge.
- Low-level switch-off takes place at approx. 80 mm below the bath bridge!  
(Protection testing (⇒ 7.11.3))

### Emptying

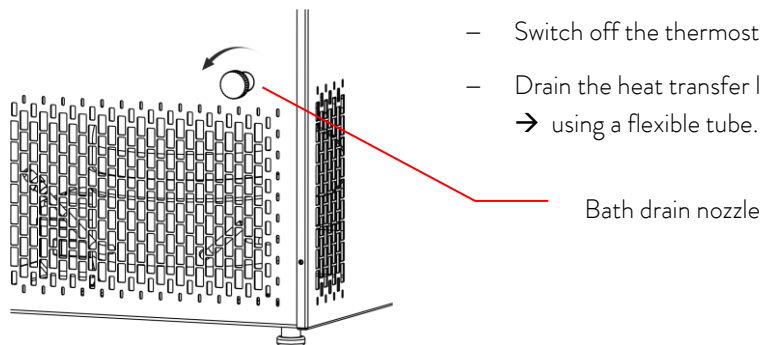

- Switch off the thermostat, pull out the mains plug!
- Drain the heat transfer liquid through the drain nozzle  
→ using a flexible tube.

Bath drain nozzle



- The units are designed for operation with non-flammable liquids to DIN EN 61010-2-010 → water or glycol/ water mixture.
- When starting up the unit, the tubular heater has to be covered with liquid!
- When connecting an external consumer take care of the heat transfer liquid level for it must not decrease too much → fill in heat transfer liquid if necessary.



- Do not drain the heat transfer liquid when it is hot or very cold (below 0 °C)!

## 6.3 Heat transfer liquids and hoses

### Approved heat transfer liquids

LAUDA Designation	Working temperature range	Chemical Designation	Viscosity <sub>kin</sub>	Viscosity <sub>kin</sub> @ temperature	Size		
					Catalogue number		
	from °C to °C		mm <sup>2</sup> /s at 20 °C	mm <sup>2</sup> /s	5 L	10 L	20 L
Aqua 90 ①	5 – 90	decalcified water	1	--	LZB 120	LZB 220	LZB 320
Kryo 30 ②	-30 – 90	Monoethylen-glycol/water mixture	4	50 at -25 °C	LZB 109	LZB 209	LZB 309



- ① At higher temperatures → Evaporation losses → Use bath covers.  
Distilled water or fully deionised water must only be used with the addition of 0,1g sodium carbonate (Na<sub>2</sub>CO<sub>3</sub>)/litre water, otherwise → danger of corrosion!
- ② Water content falls after prolonged operation at higher temperatures → mixture becomes flammable (flash point 119 °C) → check the mixture ratio with a dosimeter.

Safety data sheets are available on request.



Important:

- The units are designed for operation with non-flammable liquids to DIN EN 61010-2-010.

### Hoses

Tubing type	d <sub>i</sub> x t [mm]	Temperature range °C	Application	Catalogue number
EPDM-tubing, non-insulated	9 x 2	10 – 90	for all LAUDA heat transfer liquids except for Ultra 350 and mineral oils	RKJ 111
EPDM-tubing, non-insulated	12 x 2	10 – 90	for all LAUDA heat transfer liquids except for Ultra 350 and mineral oils	RKJ 112
Silicone tubing, insulated	11	-60 – 100	for all LAUDA heat transfer liquids except silicone oils	LZS 007



- Protect tubing with hose clips against slipping off!



**IMPORTANT:** There are differences between “water and water”!

- Tap water may be unsuitable for operation due to the calcium carbonate content → risk of calcification of the stainless steel tank.
- High purity water (from ion exchangers) and distilled or bidistilled water are unsuitable for operation due to the corrosive properties of these media. → High purity water and distillates are suitable as a medium after the addition of 0.1 g of soda ( $\text{Na}_2\text{CO}_3$ , sodium carbonate) per liter of water.

LAUDA Alpha thermostats can be operated ideally with LAUDA Aqua 90, available in container sizes of 5, 10 or 20 liters (order number LZB 120, LZB 220 or LZB 320) or with Kryo 30 (⇒ 6.3).



- There is a risk of electrochemical oxidation with the use of racks of non-ferrous metals or non-ferrous metal samples.
- The LAUDA Alpha thermostat tanks are produced in stainless steel 1.4301 and are accordingly resistant to mechanical and chemical stresses.
- Due to the different electrochemical potentials of metals electrochemical oxidation may occur in the case of direct contact between the tank and a rack (for example copper) and the bath may corrode despite the use of the highest quality materials for the tank.

Avoid the use of this type of rack or the direct contact with this sort of rack or contact with non-ferrous metal samples and the inside of the container. Use original LAUDA stainless steel racks and commercially available racks in temperature-resistant plastics!

## 6.4 Connection of external circuits

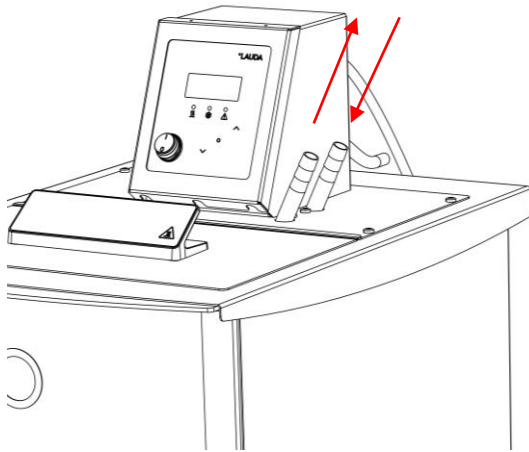

### Operation as circulation thermostat

An external circulation set is installed as standard for cooling thermostats and available as accessory for immersion and heating thermostats (⇒ 9).

Assembly for immersion/heating thermostats only:

- Pull out the mains plug!
- Fix the external circulation set at the bottom of the control head by means of the two screws (pan head with cross recess). The external circulation set belongs to the right side of the head. Connect the pump outlet with the short pump nozzle using the L-shaped tubing.
- Hang the thermostat into the bath and fix the clamp with the knurled thumb screw on the edge of the bath.
- When used as circulation thermostat, care for shortest hose connections with largest inner diameter as possible. This gives the best flow.
- Connect 9 mm internal diameter tubing from your application to the pump connections.
  - Pump connections
    - return to bath
    - pump outflow or pump pressure side.



Pump connection link (silicone rubber)



- If the cross-section of the tubing is too small → temperature drop between bath and external system due to low flow rate. Increase the bath temperature appropriately.
- Always ensure the maximum possible flow cross-section in the external circuit!



- If the external consumer is placed at a higher level than the thermostat, the pump is stopped and air penetrates into the thermostating circuit, the external liquid may drain down into the bath even with a closed system → danger of flooding the thermostat!
- Protect tubing with hose clips against slipping off!!
- When no external consumer is connected to the thermostat, the pump outflow connection must be linked to the return (pump connection link).



## 7 Starting up

### 7.1 Connection to the supply

Compare the supply voltage with the data on the rating label (rearside on control head).



- Connect the unit only to a grounded mains power socket (PE).
- No warranty when the thermostat is connected to a wrong supply!
- Please make sure that your mains plug is equipped with at least the following safety fuses (⇒ 10).

Power supply	Fuse protection
230 V~	12 A
115 V~	15 A
100 V~	15 A

- The start current of the refrigerating machine may exceed those currents distinctly for a short time.
- Ensure that the unit is filled in accordance with Section (⇒ 6.2).





**Note for electric installation on site:**

The devices must be protected with a 16 ampere circuit breaker fitted during installation.

Exception: Devices with 13 ampere UK plugs.

### 7.2 Switching on

1 s

- Switch on at the mains switch; an acoustic signal is emitted for about one second.

---

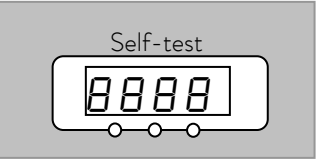

- Initial check of display and indicators; software version is shown and the self-test becomes initiated.

---

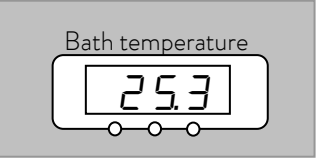







- The current bath temperature is shown on the display.



- If necessary add more heat transfer liquid to replace the amount pumped out to the external circuit.









### 7.3 General key functions and pilot lamps

Your Alpha Thermostat is easy to operate.

 <p>Enter Key</p>	<ul style="list-style-type: none"> <li>– Switch from the current bath temperature display to the main menu;</li> <li>– activates input, display flashes;</li> <li>– saves input, display ceases to flash and menu point is left.</li> </ul>
 <p>Smart Decrement / Increment Button</p>	<ul style="list-style-type: none"> <li>– Selection of sub menu or setting of numerical values.</li> </ul> <p>Speeds up entry by moving the counting position to the left:</p> <ul style="list-style-type: none"> <li>– Keys are pressed and held down.</li> </ul> <p>Moves counting position to the right:</p> <ul style="list-style-type: none"> <li>– Switching one place to the right occurs by briefly (1 second) releasing the key, followed by another pressing of the key.</li> <li>– Most relevant settings are accepted automatically after approximately 4 seconds</li> <li>or</li> <li>– the setting is accepted immediately pressing the &lt;Enter&gt; key.</li> </ul>
 <p>(or 4 sec.)</p>	<ul style="list-style-type: none"> <li>– Fault signal: Flashing red Alarm LED and acoustic signal.</li> </ul>
 <p>and</p>	
	<ul style="list-style-type: none"> <li>– Heating is active when the yellow LED is lit.</li> </ul>
	<ul style="list-style-type: none"> <li>– Cooling is active. When the setpoint temperature is lowered, it may take up to one minute before the blue LED is lit.</li> </ul>







## 7.4 Temperature setpoint setting *SEt*

The setpoint is the temperature, which the thermostat should reach and maintain constant.

	- Press key to show <i>SEt</i> (Setpoint).
	- Press, display flashes.
 or 	- Decrement or increment the Temperature Setting (⇒ 7.3). (Temperature can be set from -25 °C up to 100 °C depending on limits “Hi” and “Lo”).
Wait 4 seconds or 	- Display flashes 4 seconds → new value is automatically accepted, or value is accepted immediately with <Enter> key.
	- When the setpoint temperature is set below the bath temperature, it may take up to one minute before the blue LED  lights.
	- Entering value closer than 5 °C to the maximum or minimum temperature limit (Hi and Lo) are not accepted. A buzzer signal appears. If necessary, first change the temperature limits (⇒ 7.6).

## 7.5 Automatic Shutdown Timer *ASd*

The automatic Shutdown Timer can be activated/deactivated, read out or be set. At shutdown time, the pump, heater and compressor are deactivated, the display then shows “*Stby*” (⇒ 7.10).

 1x  to <i>ASd</i>	- Call the Automatic Shut-Down Timer <i>ASd</i> .
	<u>Read Timer:</u>
	The display shows... “ <i>00.00</i> ”: timer not active;
	The display shows... “ <i>hh mm</i> ” (any value): timer active, ( <i>hh.mm</i> minutes remaining to shutdown)
 or 	<u>Set Timer:</u>
	Increment or decrement “ <i>hh mm</i> ” (maximum 99:59) <i>Within 4 seconds after the last change of values confirm the timer value by pressing &lt;Enter&gt;.</i>
	You then proceed to Main Menu “Bath Temperature”: A <b>blinking</b> point indicates that the timer is running!!
	- No change is done without confirmation by <Enter>! - You can deactivate the timer any time by setting the value “ <i>00.00</i> ”.

## 7.6 Defining temperature limits *Hi* and *Lo*

With this function, it is possible to define a minimum and a maximum temperature in which the thermostat controls. By reaching the temperature limits, a warning appears. In this way setpoint input can be prevented which may damage the heat transfer medium or the apparatus. For example, if water is used as the heat transfer liquid, 95 °C would be practicable as the maximum temperature and 5 °C as the minimum temperature. The default values are  $H_i = 105\text{ °C}$  and  $Lo = -30\text{ °C}$ .

	<ul style="list-style-type: none"> <li>– Select option <i>Hi</i> (maximum temperature), or option <i>Lo</i> (minimum temperature) using the key .</li> <li>– Enter the selection</li> </ul>
	<p>The maximum temperature can be set from 35 °C to 105 °C.</p>
	<p>The minimum temperature can be set from -30 °C to 30 °C.</p>
	<p>The current temperature limit value is displayed flashing.</p>
<p>Wait 4 seconds or</p>	<ul style="list-style-type: none"> <li>– Set the required temperature limit.</li> <li>– Display flashes 4 seconds → new value is automatically accepted, or</li> <li>– By pressing the &lt;Enter&gt; key the value is accepted immediately.</li> </ul>

## 7.7 Refrigeration unit submenu *Cool*

Menu *Cool* only with cooling thermostats.





	<ul style="list-style-type: none"> <li>– Call the option <i>Cool</i>.</li> </ul>
	<ul style="list-style-type: none"> <li>– Configure the refrigeration system with these possible settings:  <i>Auto</i>      automatic refrigeration mode;  <i>on</i>          refrigeration on duty;  <i>off</i>         refrigeration out of duty.</li> </ul>
<p>Wait 4 seconds or</p>	<ul style="list-style-type: none"> <li>– The selected mode is displayed flashing.</li> <li>– Display flashes 4 s → new selection is automatically accepted, or</li> <li>– it is immediately accepted with the &lt;Enter&gt; key.</li> </ul>

## 7.8 Offset for the internal temperature probe *CAL*



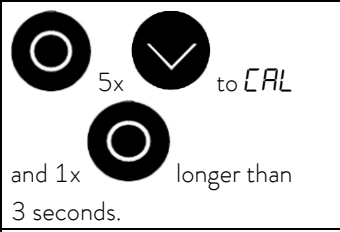

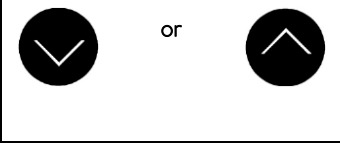
Keep attention: All change done here cause the loss of factory calibration!

Calibration should only be activated if a sufficiently accurate temperature measurement device is available as reference.

If, during checking with a calibrated reference thermometer, (for example from the LAUDA DigiCal Series), a deviation is found, then the offset (i.e. the additive part of the characteristic) of the internal measuring chain can be adjusted with the following function. The reference thermometer must be dipped into the bath according to the details on the calibration certificate. Only offset values of  $\pm 5$  Kelvin are accepted. Switching on the unit, the last used CAL value is preloaded again.

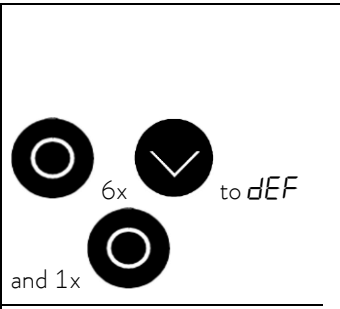
 <p>5x  to <i>CAL</i> and 1x  longer than 3 seconds.</p>	<ul style="list-style-type: none"> <li>- Call the option <i>CAL</i>.</li> </ul>
 <p>or</p>	<ul style="list-style-type: none"> <li>- Display flashes. Enter the value of the reference thermometer.</li> <li>- The selected value is displayed flashing.</li> </ul>
<p>Wait 4 seconds or</p> 	<ul style="list-style-type: none"> <li>- Display flashes 4 s → new value is accepted automatically, or</li> <li>- value is immediately accepted with the &lt;Enter&gt; key.</li> </ul>

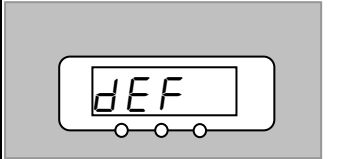
## 7.9 Restoring works settings *DEF*

 <p>6x  to <i>DEF</i> and 1x  longer than 3 seconds.</p>	<p>If you would like to restore all the works settings except the probe calibrations <i>CAL</i> ...</p> <ul style="list-style-type: none"> <li>- call the works settings <i>DEF</i>.</li> </ul>
 <p>3 seconds long </p>	<ul style="list-style-type: none"> <li>- <i>DEF</i> is flashing.</li> <li>- Press &lt;Enter&gt; more than 3 seconds (display flickering).</li> <li>- After button release the changeover is acknowledged with <i>done</i>, the unit returns back to the mode "Bath temperatur".</li> </ul>
	<ul style="list-style-type: none"> <li>- Reset Values: Set = 25 °C, Hi = 105 °C, Lo = -30 °C, Cool = Auto</li> </ul>

## 7.10 Standby *Stby*

The status “Standby” follows any automatic Shut-Down procedure. To reactivate the standard operation menu, press the <Enter> button and for example modify the latest Setpoint.

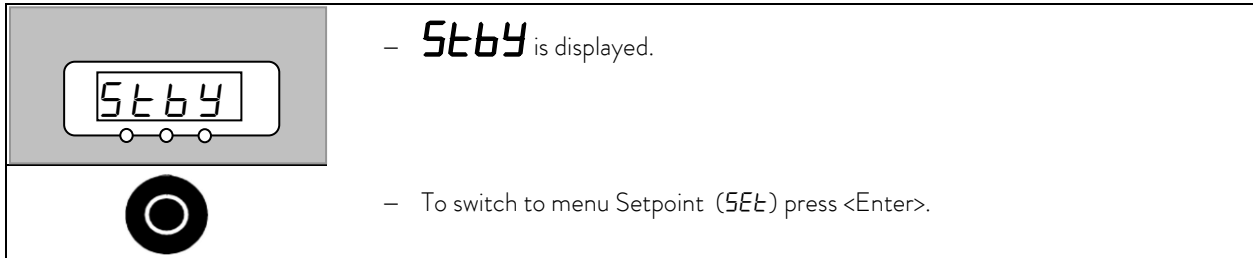

## 7.11 Safety functions

### 7.11.1 Safety functions and removal

Your Alpha Thermostat triggers alarms, warnings or errors as appropriate. All warnings, alarms or errors are shown on the LED display.

**Alarms:** Alarms are safety relevant. Components (Pump / Heater / Refrigerating Unit) will be shut down.



**Errors:** When an error occurs switch off the device. If the error is always present after switching on the device, please inform the LAUDA Service (⇒ 8.5) or the local service organisation!

Find cause of alarm, warning or error and rectify where necessary. Then press  on the control head in order to remove the message.

Warnings may be ignored by pressing  or  on the control head.



## 7.11.2 Overtemperature and low level protection

 The units are designed for operation only with non-flammable liquids to DIN EN 61010-2-010.

**Overtemperature alarm**



- The overtemperature cut-off point is activated close above 105 °C and can not be changed.
- If the bath temperature rises above the overtemperature cut-off point or the liquid level is too low (⇒ 6.2):
  1. Alarm sounds as dual-tone signal.
  2. **SAFE** for overtemperature cut-off point appears in the display.
  3. The red LED  above the fault triangle  flashes.
    - Heater switches off on all poles;
    - Pump and refrigerating unit are switched off electronically.
- Rectify cause of fault.
- Wait until the bath temperature has cooled below the cut-off point.



Unlock the thermostat (⇒ 7.11.4).

## 7.11.3 Overtemperature and low level protection testing

Every 6 month or before the unit is running unattended for longer periods this protection should be tested.



Therefore:

- Remove the heat transfer liquid of the thermostat (⇒ 6.2).
- Turn on thermostat and set the set temperature to a value a couple degrees above ambient temperature.
- The heater of the thermostat will now start heating. Attention the heater will get very hot. Don't touch it at any time.
- Wait about 45 seconds until the protection device will shut off the heater and the pump and the alarm **SAFE** will appear.
- If it takes more then 45 seconds for the overtemperature protection to get triggered immediately cut out the power manually and have the equipment checked by the LAUDA Service or the local service organization.
- Refill the heat transfer liquid (⇒ 6.2).
- Unlock (reset) the alarm (⇒ 7.11.4).
- Shut off the control head and turn it on again. The alarm must have disappeared now.

 

**Overtemperature alarm**



 

#### 7.11.4 Unlock the overtemperature protection

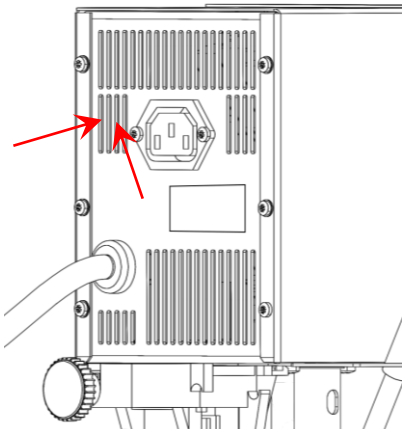

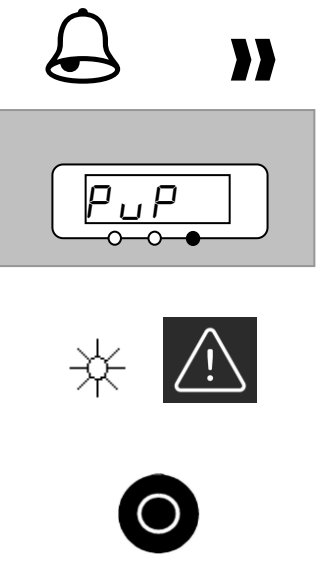

- Switch off the thermostat, pull out the mains plug!
- To unlock the protection, push the reset knob behind the ventilation grille (see arrows). You can use for example a pen.
- Switch on the thermostat.

#### 7.11.5 Pump-motor supervision: Overload



A temperature sensor monitors the pump:

1. Alarm sounds as dual-tone signal for pump-motor overload or blockage.
2. Display of *PuP* signals blockage.
3. The red LED  above the fault triangle  flashes.
  - Heater switches off on both poles;
  - Pump and refrigerating unit are switched off electronically.

- Switch off the thermostat, pull out the mains plug!
- Find the cause of the fault. Perhaps the viscosity of the heat transfer liquid is too high or the pump is blocked.
- Rectify cause of fault.
- Press the <Enter> key.
- Also press this key if the unit has been switched off in the fault state.



## 7.11.6 Fault list “Alarms and Errors”

### Alarms

Message on display	Meaning
<i>oUrT</i>	Bath temperature > overall maximum temperature 110 °C
<i>hEAd</i>	Temperature in control head > 75 °C
<i>SAFE</i>	Low level overheat protection has tripped
<i>PuP</i>	Pump blocked (no rotation)
<i>Hi</i>	Bath temperature > maximum temperature (⇒ 7.6)
<i>Lo</i>	Bath temperature < minimum temperature (⇒ 7.6)

### Errors

Message on display	Meaning
<i>E001</i>	Sensor Issue (short)
<i>E002</i>	Sensor Issue (open); unexpected sensor value



- If there is any irregularity when testing the safety devices, switch off the unit immediately and pull out the mains plug!
- Have the unit checked by the [LAUDA Service](#) or the local service organisation!
- The heater surface can reach temperatures up to 250 °C when there is not enough liquid in the bath → Danger of burning injuries. Use only non-flammable liquids, otherwise → Danger of fire!

## 8 Maintenance

### 8.1 Cleaning



- Before cleaning the unit, pull out the mains plug!

The unit can be cleaned with water adding a few drops of detergent (washing up liquid), using a moist cloth.



- Water/ heat transfer liquid must not enter the control unit!



- Carry out appropriate detoxification if dangerous material has been spilled on or inside the unit.
- Method of cleaning and detoxification are decided by the special knowledge of the user. In case of doubt please contact the manufacturer.

### 8.2 Maintenance



- Before any maintenance and repair work pull out the mains plug!
- Repairs on the control unit must only be carried out by properly qualified personnel!

If the heat transfer liquid becomes contaminated, it has to be replaced.

#### 8.2.1 Service intervals

System part	Frequency	Comment
	Each time of putting into operation and then	
<b>Complete device</b>		
External condition of the device	Monthly	
<b>Heat transfer liquid</b>		
Test of the heat transfer liquid	(⇒ 8.2.2)	
<b>Heat transfer system</b>		
Sealing	Daily	External visual inspection
<b>External hoses</b>		
Material fatigue	Monthly	External visual inspection
<b>Cooling unit</b>		
Condenser cleaning	(⇒ 8.2.3)	Cooling thermostat
<b>Electronics</b>		
Over temperature protection	(⇒ 7.11.3)	
Low level protection testing	(⇒ 7.11.3)	

## 8.2.2 Testing the heat transfer liquid

If the heat transfer liquid becomes contaminated, it has to be replaced (⇒ 6.2 and 6.3).

If required, the heat carrier should be checked for capability for use (for example when changing the method of operation), or at least half-yearly. Further use of the heat carrier is only permissible if the inspection indicates this.

The test of the heat transfer liquid should take place according to DIN 51529; Testing and assessment of used heat transfer media. Source: VDI 3033; DIN 51529.

## 8.2.3 Maintenance of the refrigeration unit

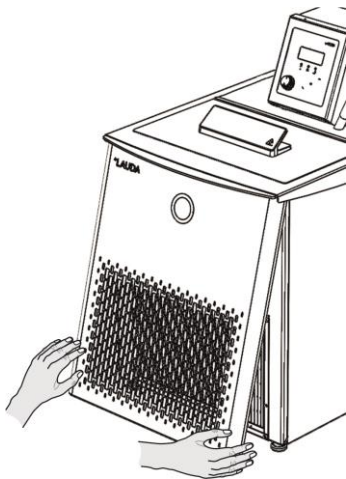

### Condenser cleaning

The refrigeration unit operates largely without maintenance.

Depending on the ambient dust conditions and the operating time, any dust on the heat exchanger (condenser) must be removed at intervals of 2 weeks or longer.

This is done after taking off the front grille. Brush off the condenser and if necessary blow through with compressed air.

## 8.3 Note on repair

If you need to send in a unit for repair, it is essential to first contact the **LAUDA Service** (⇒ 8.5).



- If the equipment has to be returned to the factory, please ensure that it is packed carefully and properly. LAUDA accepts no responsibility for damage due to unsatisfactory packing.

## 8.4 Disposal information



The following applies to Europe: The disposal of the device is regulated by EU Directive 2012/19/EU (WEEE Waste of Electrical and Electronic Equipment).

### 8.4.1 Disposal of refrigerant

The type and filling quantity of the refrigerant can be read on the unit or on the rating plate. Repair and disposal only through a qualified refrigeration engineer!

The refrigerant must be disposed of in accordance with regulation 2015/2067/EU in combination with regulation 517/2014/EU.

### 8.4.2 Disposal of packaging

The packaging must be disposed of in accordance with EU Directive 94/62/EC.

## 8.5 Ordering spares and rating label

When ordering spares please quote instrument type and serial number from the rating label. This avoids queries and supply of incorrect items.

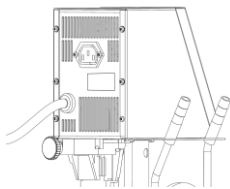
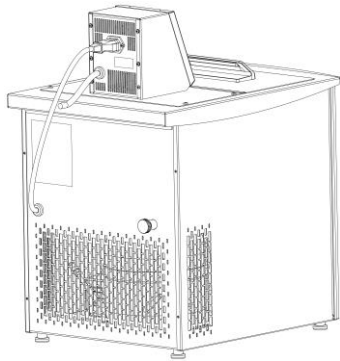

Rating label at immersion/heating thermostats

Contact LAUDA Service Constant Temperature Equipment in the following cases:

- In the event of faults on the machine
- For spare part orders
- In the case of questions about the machine

Contact our Sales Department for application-specific questions.



### LAUDA Service

Phone: +49 (0)9343 503-350 (English and German)

Fax: +(0)49 9343 503-283

E-mail: [service@lauda.de](mailto:service@lauda.de)

We are available any time for your queries and suggestions!

### LAUDA DR. R. WOBSE GMBH & CO. KG

Laudaplatz 1

97922 Lauda-Königshofen

Germany

Phone: +49 (0)9343 503-0

Fax: +49 (0)9343 503-222

E-mail: [info@lauda.de](mailto:info@lauda.de)

Internet: <http://www.lauda.de/>

## 9 Accessories

### Accessories for Class Alpha thermostats

Description		suitable for	Catalogue number
Cooling coil set		for all heating thermostats	LCZE 004
External circulation set		for all heating thermostats	LCZE 005
Bath cover		A 6	LCZE 006
Bath cover		A 12	LCZE 007
Bath cover		A 24	LCZE 008
Rack for 12 tubes, d = 20 mm	stainless steel, 180 mm x 60 mm x 80 mm, -40 – 200 °C	two racks fit in each of A 12 one rack fits in each of RA 12 six racks fit in each of A 24 and RA 24	UE 038
Rack for 90 tubes, d = 13 mm	PP white, 250 mm x 100 mm x 65 mm, 0 – 135 °C	two racks fit in each of RA 12 three racks fit in each of A 24 and RA 24	UE 037
Rack for 60 tubes, d = 16 mm	PP white, 250 mm x 100 mm x 65 mm, 0 – 135 °C	two racks fit in each of RA 12 three racks fit in each of A 24 and RA 24	UE 042
Rack for 40 tubes, d = 20 mm	PP white, 250 mm x 100 mm x 65 mm, 0 – 135 °C	two racks fit in each of RA 12 three racks fit in each of A 24 and RA 24	UE 039
Rack for 24 tubes, d = 25 mm	PP white, 250 mm x 100 mm x 65 mm, 0 – 135 °C	two racks fit in each of RA 12 three racks fit in each of A 24 and RA 24	UE 040
Rack for 21 tubes, d = 30 mm	PP white, 250 mm x 100 mm x 65 mm, 0 – 135 °C	two racks fit in each of RA 12 three racks fit in each of A 24 and RA 24	UE 041

Rack for 90 tubes, d = 13 mm	PP yellow, 250 mm x 100 mm x 65 mm, 0 – 135 °C	two racks fit in each of RA 12 three racks fit in each of A 24 and RA 24	UE 043
Rack for 60 tubes, d = 16 mm	PP yellow, 250 mm x 100 mm x 65 mm, 0 – 135 °C	two racks fit in each of RA 12 three racks fit in each of A 24 and RA 24	UE 048
Rack for 40 tubes, d = 20 mm	PP yellow, 250 mm x 100 mm x 65 mm, 0 – 135 °C	two racks fit in each of RA 12 three racks fit in each of A 24 and RA 24	UE 045
Rack for 24 tubes, d = 25 mm	PP yellow, 250 mm x 100 mm x 65 mm, 0 – 135 °C	two racks fit in each of RA 12 three racks fit in each of A 24 and RA 24	UE 046
Rack for 21 tubes, d = 30 mm	PP yellow, 250 mm x 100 mm x 65 mm, 0 – 135 °C	two racks fit in each of RA 12 three racks fit in each of A 24 and RA 24	UE 047

All racks are delivered without test tubes.

For further accessories please refer to our Accessories Catalog or contact us directly (⇒ 8.5).

## 10 Technical data and diagrams

*The figures have been determined according to DIN 12876.*

Common technical data of Alpha Thermostats		
Ambient temperature range	°C	5 – 40
Humidity		Maximum relative humidity 80 % for temperatures up to 31 °C, decreasing linearly to 50 % relative humidity at 40 °C
Storage temperature range	°C	-50 – 70
Temperature stability at 37 °C	K	±0.05
Display & setting resolution	°C	0.1
Pump type / number of pump steps	--	Pressure pump / 1
Connections for consumers (accessory)	---	Hose nozzle ½", 12.7 mm external diameter
Heater power		
230 V; 50/60 Hz	kW	1.5
115 V; 60 Hz	kW	1.15
100 V; 50/60 Hz	kW	1.0 (⇒ 7.1)
Least mains fuse protection		
230 V~	A	12
115 V~	A	15
100 V~	A	15
Safety Class	---	1/NFL* according to DIN 12876
Protection class	---	Protection class I according to DIN EN 61140; VDE 0140-1

\*NFL non-flammable liquids

*Product specifications are subject to change without notice!*

Alpha Immersion Thermostat		
Working temperature range	°C	25 – 100
Operating temperature range	°C	-25 – 100
Pump flow	L/min	15
Pump pressure	bar	0.2
Bath volume	L	up to 50
Connections for cooling coil (accessory)	---	Hose nozzle 11.7 mm external diameter
Overall dimensions (W x D x H)	mm	125 x 150 x 300
Weight	kg	3.5
Ingress protection rating IP Code according to IEC 60529	---	IP 20

Power supply		Power consumption
230 V~ ±10 %; 50/60 Hz	kW	1.5
115 V~ ±10 %; 60 Hz	kW	1.2
100 V~ ±10 %; 50/60 Hz	kW	1.0

*Product specifications are subject to change without notice!*



Alpha Heating and Cooling Thermostats							
	Units	A 6	A 12	A 24	RA 8	RA 12	RA 24
Working temperature range	°C	25 – 100			-25 – 100		
Operating temperature range	°C	-25 – 100			-25 – 100		
Cooling capacity (eff.), ethanol @ 20 °C ambient temperature	20 °C	W	X	X	225	325	425
	10 °C	W			190	300	370
	0 °C	W			160	260	330
	-10 °C	W			130	210	225
	-20 °C	W			80	80	80
	-25 °C	W			30	30	20
Pump flow	L/min	15					
Pump pressure	bar	0.2					
Bath volume	L	2.5 – 5.5	8 – 12	18 – 25	5 – 7.5	9.5 – 14.5	14 – 22
Bath vessel	---	Inner tank in stainless steel					
Housing	---	Powder-coated steel sheet					
Feet	---	Four mounting feet					
Bath opening (W x D) with Head	mm	145 x 161	235 x 161	295 x 374	165 x 177	300 x 203	350 x 277
Bath opening (W x D) without head	mm	145 x 295	235 x 295	295 x 500	X	X	X
Bath depth	mm	150	200	200	160	160	160
Useable bath depth	mm	130	180	180	140	140	140
Height of top edge of bath without cover	mm	212	262	262	450	450	450
Overall dimensions (W x D x H)	mm	181 x 332 x 370	270 x 332 x 420	332 x 535 x 420	235 x 500 x 605	365 x 500 x 605	415 x 605 x 605
Weight	kg	6.2	7.5	10.5	31	37	43
Ingress protection rating IP Code accord. to IEC 60529	---	IP 20			IP 20		

Power consumption							
Power supply	Units	A 6	A 12	A 24	RA 8	RA 12	RA 24
230 V~ ±10 %; 50/60 Hz	kW	1.5	1.5	1.5			
230 V~ ±10 %; 50 Hz	kW				1.8	1.8	1.8
220 V~ ±10 %; 60 Hz	kW				1.8	1.8	1.8
115 V~ ±10 %; 60 Hz	kW	1.2	1.2	1.2	1.5	1.5	1.5
100 V~ ±10 %; 50/60 Hz	kW	1.0	1.0	1.0	1.3	1.3	1.3

### Refrigerant and filling quantity

The cooling thermostat contains fluorinated greenhouse gases.

	Units	RA 8	RA 12	RA 24
Refrigerant	---	R-134a	R-134a	R-134a
maximum filling quantity	kg	0.11	0.13	0.17
GWP <sub>(100a)</sub> *	---	1430	1430	1430
CO <sub>2</sub> equivalent	t	0.2	0.2	0.2



Global Warming Potential (GWP),  
Comparison CO<sub>2</sub> = 1,0

\*Time span 100 years - according to IPCC IV

*Product specifications are subject to change without notice!*

## Pump characteristics Alpha Immersion Thermostat

measured with water

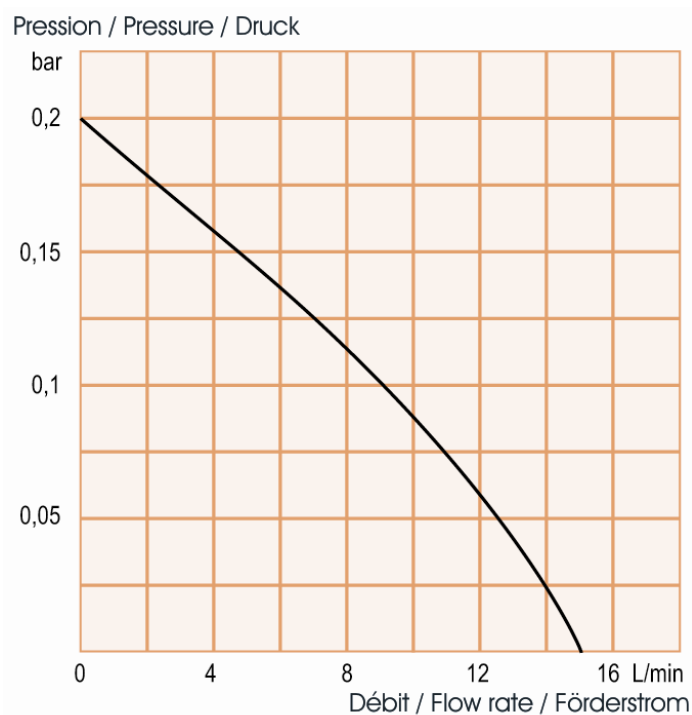

## Heating up curves from Alpha A 6, A 12 and A 24 (230 V~)

Courbes de montée en température / Heating up curves / Aufheizkurven  
Cuve ouvert avec eau / Open bath with water / Offenes Bad mit Wasser

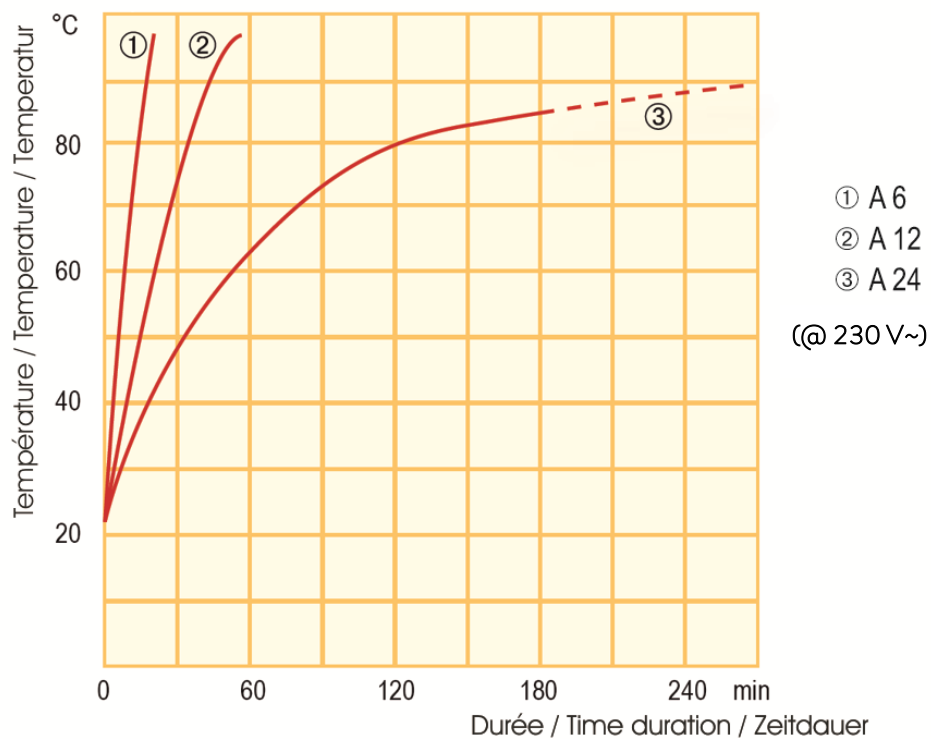

Cooling characteristics Alpha RA 8, RA 12 and RA 24 (230 V~)

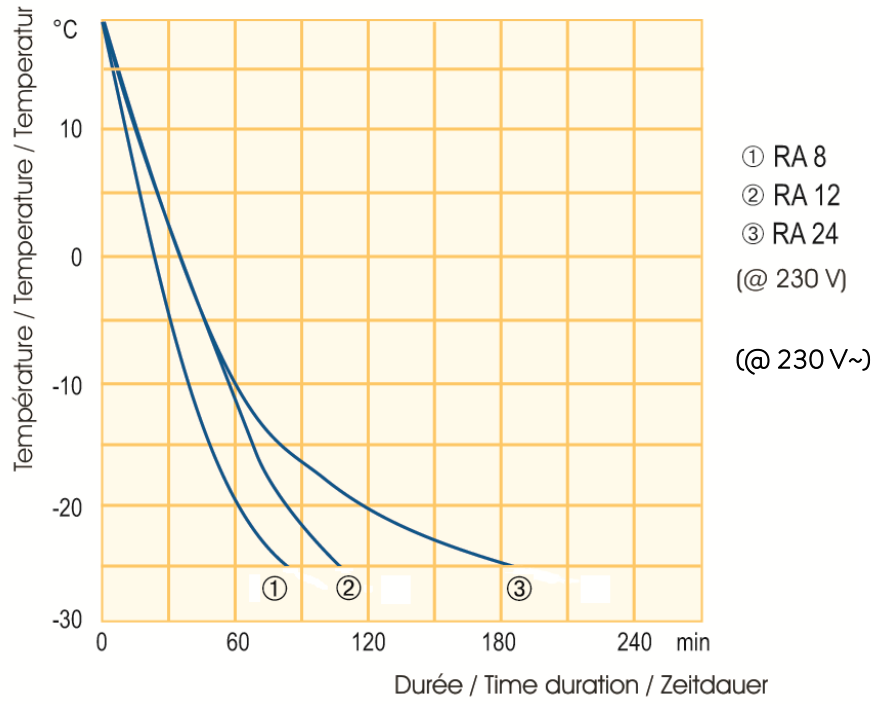

## 11 Declaration of Conformity and Product Returns



### EU DECLARATION OF CONFORMITY

**Manufacturer:** LAUDA DR. R. WOBSEY GMBH & CO. KG  
Laudaplatz 1, 97922 Lauda-Königshofen, Germany

We hereby declare under our sole responsibility that the machines described below

**Product Line:** Alpha **Serial number:** from CN210000001

**Types:** A, A 6, A 12, A 24

comply with all relevant provisions of the EC Directives listed below due to their design and type of construction in the version brought on the market by us:

Machinery Directive	2006/42/EC
EMC Directive	2014/30/EU
RoHS Directive	2011/65/EU in connection with (EU) 2015/863

The equipment is not covered by the Pressure Equipment Directive 2014/68/EU, as the maximum classification of the equipment is Category 1 and it is covered by the Machinery Directive.

The protective objectives of the Machinery Directive with regard to electrical safety are complied with in accordance with Annex I Paragraph 1.5.1 in conformity with the Low Voltage Directive 2014/35/EU.

Applied standards:

- EN ISO 12100:2010
- EN 61326-1:2013
- EN 61010-1:2010/A1:2019/AC:2019-04

Authorized representative for the composition of the technical documentation:

Dr. Jürgen Dirscherl, Director Research & Development

Lauda-Königshofen, 20.06.2022

  
Dr. Alexander Dinger, Head of Quality Management



## EU DECLARATION OF CONFORMITY

**Manufacturer:** LAUDA DR. R. WOBSE GMBH & CO. KG  
Laudaplatz 1, 97922 Lauda-Königshofen, Germany

We hereby declare under our sole responsibility that the machines described below

**Product Line:** Alpha **Serial number:** from CN210000001

**Types:** RA 8, RA 12, RA 24

comply with all relevant provisions of the EC Directives listed below due to their design and type of construction in the version brought on the market by us:

Machinery Directive	2006/42/EC
EMC Directive	2014/30/EU
RoHS Directive	2011/65/EU in connection with (EU) 2015/863

The equipment is not covered by the Pressure Equipment Directive 2014/68/EU, as the maximum classification of the equipment is Category 1 and it is covered by the Machinery Directive.

The protective objectives of the Machinery Directive with regard to electrical safety are complied with in accordance with Annex I Paragraph 1.5.1 in conformity with the Low Voltage Directive 2014/35/EU.

Applied standards:

- EN ISO 12100:2010
- EN 61326-1:2013
- EN 378-2:2018
- EN 61010-1:2010/A1:2019/AC:2019-04

Authorized representative for the composition of the technical documentation:

Dr. Jürgen Dirscherl, Director Research & Development

Lauda-Königshofen, 20.06.2022

Dr. Alexander Dinger, Head of Quality Management

\*FAHRENHEIT, \*CELSIUS, \*LAUDA.

Document number: Q5WA-QA13-017-EN Version 04

## Product Returns and Clearance Declaration

### Product Returns

Would you like to return a LAUDA product you have purchased to LAUDA? For the return of goods, e.g. for repair or due to a complaint, you will need the approval of LAUDA in the form of a *Return Material Authorization (RMA)* or *processing number*. You can obtain the RMA number from our customer service department at +49 (0) 9343 503 350 or by email [service@lauda.de](mailto:service@lauda.de).

### Return address

LAUDA DR. R. WOBSEER GMBH & CO. KG

Laudaplatz 1

97922 Lauda-Königshofen

Deutschland/Germany

Clearly label your shipment with the RMA number. Please also enclose this fully completed declaration.

RMA number	Product serial number
Customer/operator	Contact name
Contact email	Contact telephone
Zip code	Place
Street & house number	
Additional explanations	

### Clearance Declaration

The customer/operator hereby confirms that the product returned under the above-mentioned RMA number has been carefully emptied and cleaned, that any connections have been sealed to the farthest possible extent, and that there are no explosive, flammable, environmentally hazardous, biohazardous, toxic, radioactive or other hazardous substances in or on the product.

Place, date	Name in block letters	Signature

Version 02 - EN

## 12 Copyright

This manual is protected by copyright and only meant for internal use by purchasers.

The relinquishment of this manual to third parties, copying in any way whatsoever – even in the form of excerpts – and the utilization and/or conveyance of its content are not allowed, except for internal purposes, without written approval from the manufacturer.

Violation of this may obligate the violator to the payment of damages. Other claims reserved.

We point out that the designations and brand names of the respective companies used in the manual are generally subject to trademark, brand and patent protection.



## 13 Index

### A

Accessories .....	37
Standard accessories.....	17
Alarms.....	30
<b>ASd</b> .....	27
Automatic Shutdown Timer .....	27

### B

Baths.....	15
------------	----

### C

<b>CAL</b> .....	29
Circuit breaker .....	25
Cleaning .....	34
<b>COOL</b> .....	28

### D

<b>dEF</b> .....	29
Drain nozzle.....	21

### E

EMC standard DIN EN 61326-1 .....	6
Enter Key .....	26
Errors.....	30

### F

Fault list "Alarms and Warnings" .....	33
Filling quantity.....	42

### G

GWP .....	42
-----------	----

### H

Heat transfer liquid, Testing.....	35
------------------------------------	----

<b>H i</b> .....	28
------------------	----

### K

Key functions .....	26
---------------------	----

### L

LED signals.....	26
<b>Lo</b> .....	28
Low level protection.....	31
Low level Protection testing.....	31

### M

Maintenance .....	34
-------------------	----

### O

Overtemperature cut-off .....	31
Overtemperature protection .....	31

### P

<b>Packaging</b> .....	35
Personnel, qualified.....	6
Pump connection link.....	24
<b>PUP</b> Pump blocked .....	32

### R

Refrigerant .....	42
Reset.....	32

### S

<b>SAFE</b> Overtemperature alarm.....	31
Self-test.....	25
<b>Service intervals</b> .....	34
<b>SEt</b> .....	27
Setting of numerical values .....	26
Spares .....	36

Standby ..... 30  
5t64 ..... 30

## T

Temperature  
Limit temperature ..... 28  
maximum temperature ..... 28

minimum temperature ..... 28

## U

UK plugs ..... 25

## W

Warnings ..... 30



LAUDA DR. R. WOBSE GMBH & CO. KG ° Laudaplatz 1 ° 97922 Lauda-Königshofen  
Telephone: +49 (0)9343 503-0 ° Fax: +49 (0)9343 503-222  
E-mail: [info@lauda.de](mailto:info@lauda.de) ° Internet: <https://www.lauda.de>