

# Transferpette® electronic

Gebrauchsanleitung · Operating Manual · Mode d'emploi

Instrucciones de manejo · Istruzioni per l'uso · 操作手册



# EG-Konformitätserklärung

## EC-Conformity Declaration

Das bezeichnete Gerät entspricht den einschlägigen Anforderungen der aufgeführten EG-Richtlinien und Normen. Die alleinige Verantwortung für die Ausstellung dieser Konformitätserklärung trägt der Hersteller. Bei einer nicht mit uns abgestimmten Änderung des Gerätes verliert die Erklärung ihre Gültigkeit.

The device named below fulfills the relevant fundamental requirements of the EC directives and standards listed. This declaration of conformity is issued under the sole responsibility of the manufacturer. In case of unauthorized modifications to the device, the declaration becomes invalid.

Gerätebezeichnung / Device name: Transferpette® electronic inkl. Netzteil  
Transferpette® electronic incl. charging adapter

Gerätetyp / Device type: alle baugleichen Varianten, diverse Länderausführungen  
all constructional identical variants, various national versions

Hersteller / Manufacturer: BRAND GMBH + CO KG

Adresse / Address: Otto-Schott-Str. 25  
97877 Wertheim · Germany

Der oben beschriebene Gegenstand der Erklärung erfüllt die einschlägigen Harmonisierungsrechtsvorschriften der Union: The object of the declaration described above is in conformity with the relevant Union harmonisation legislation:		Harmonisierte Normen: Harmonized standards:
IVD	98/79/EC; 1998/10	EN 61326-2-6:2002; DIN EN 61010-2-10:2002
Registriernummer / Registration Number: DE/CA37/IVD/3/13 Die Produkte sind keine Produkte des Anhang II. Die Konformitätsbewertung erfolgte gemäß Anhang III. Eine vollständige technische Dokumentation ist vorhanden. // The products are not products of annex II. The conformity assessment procedures follow annex III. A complete technical documentation is available.		

Weitere berücksichtigte Richtlinien: Other considered directives:		Harmonisierte Normen: Harmonized standards:
RoHS II	2011/65/EU; 2011/06	EN 50581:2012
EMV EMC	2014/30/EU; 2014/02	EN 61326-1:2013
Niederspannung LVD	2014/35/EU; 2014/02	DIN EN 60950-1:2006 (2nd Edition) A11:2009; A1:2010; A12:2011 + A2:2013; EN 61010-1:2010

Wertheim, 21. März 2016 / March 21, 2016

# 07.01.01.03

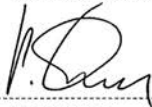

Peter Mahler  
Technischer Geschäftsführer  
Managing Director



i.A. Josef Pfohl  
Qualitätsmanagement  
Quality Management



Diese Erklärung bescheinigt die Übereinstimmung mit den genannten Harmonisierungsvorschriften,

beinhaltet jedoch keine Zusicherung von Eigenschaften.

This document declares the accordance with the named harmonized regulations, but does NOT assure specific properties.

BRAND GMBH + CO KG • info@brand.de • www.brand.de

	Seite
Sicherheitsbestimmungen	4
Funktion und Einsatzgrenzen	5
Einsatzausschlüsse	5
<b>Die Bedienelemente</b>	<b>6</b>
Die ersten Schritte	7
Volumen einstellen	8
Aufsaug- und Abgabegeschwindigkeit einstellen	9
Richtig pipettieren	10
Die Pipettierprogramme	11
<b>PIP-Modus</b>	<b>12</b>
<b>PIPmix-Modus</b>	<b>14</b>
<b>revPIP-Modus</b>	<b>16</b>
<b>Elektrophorese (GEL)-Modus</b>	<b>18</b>
<b>DISP-Modus</b>	<b>20</b>
Volumen kontrollieren	22
Genauigkeitstabelle	23
<b>Easy Calibration (Justieren)</b>	<b>24</b>
Autoklavieren	26
Referenzfahrt (rEF)	26
Wartung und Reinigung	27
Akku laden und wechseln	29
Akku-Regenerationsfunktion	30
Störung – was tun?	31
Bestelldaten · Zubehör · Ersatzteile	32
Reparatur · Kontaktadressen	34
Kalibrierservice	35
Mängelhaftung · Entsorgung	36

# Sicherheitsbestimmungen

Dieses Gerät kann in Kombination mit gefährlichen Materialien, Arbeitsvorgängen und Apparaturen verwendet werden. Die Gebrauchsanleitung kann jedoch nicht alle Sicherheitsprobleme aufzeigen, die hierbei eventuell auftreten. Es liegt in der Verantwortung des Anwenders, die Einhaltung der Sicherheits- und Gesundheitsvorschriften sicherzustellen und die entsprechenden Einschränkungen vor Gebrauch festzulegen.

## Bitte unbedingt sorgfältig durchlesen!

1. Jeder Anwender muss diese Gebrauchsanleitung vor Gebrauch des Geräts gelesen haben und beachten.
2. Allgemeine Gefahrenhinweise und Sicherheitsvorschriften befolgen, z. B. Schutzkleidung, Augenschutz und Schutzhandschuhe tragen. Beim Arbeiten mit infektiösen oder gefährlichen Proben müssen die Standardlaborvorschriften und -vorkehrungen eingehalten werden.
3. Angaben der Reagenzienhersteller beachten.
4. Gerät nicht in explosionsgefährdeter Atmosphäre betreiben und keine leicht entzündlichen Medien pipettieren.
5. Gerät nur zum Pipettieren von Flüssigkeiten im Rahmen der definierten Einsatzgrenzen und -beschränkungen einsetzen. Einsatzausschlüsse beachten (s. Seite 5)! Bei Zweifel unbedingt an den Hersteller oder Händler wenden.
6. Stets so arbeiten, dass weder der Anwender noch andere Personen gefährdet werden. Spritzer vermeiden. Nur geeignete Gefäße verwenden.
7. Die Berührung der Spitzenöffnungen ist beim Arbeiten mit aggressiven Medien zu vermeiden.
8. Nie Gewalt anwenden.
9. Nur Original-Ersatzteile verwenden. Keine technischen Veränderungen vornehmen. Das Gerät nicht weiter zerlegen, als in der Gebrauchsanleitung beschrieben ist.
10. Vor Verwendung stets den ordnungsgemäßen Zustand des Gerätes prüfen. Sollten sich Störungen des Gerätes ankündigen (z. B. schwergängiger Kolben, Undichtigkeit), sofort aufhören zu pipettieren und das Kapitel 'Störung – was tun' befolgen (Seite 31). Ggf. an den Hersteller wenden.
11. Der Original-Akku darf nicht gegen nicht-wiederaufladbare Akkus oder wiederaufladbare Akkus anderer Hersteller ausgetauscht werden.
12. Zum Aufladen des Nickel-Metallhydrid-Akkus darf nur das Original-Netzteil verwendet werden.
13. Das Netzteil ist vor Feuchtigkeit zu schützen und darf nur in Verbindung mit diesem Gerät betrieben werden.
14. Nur vollständig entladene Akkus entsprechend der Batterieverordnung entsorgen.

## Warnung!

Unsachgemäße Behandlung des Gerätes oder des Akkus (Kurzschluss, mechanische Zerstörung, Überhitzung, falsches Netzteil etc.) kann in Extremfällen zur Explosion des Akkus führen.

Bei der Transferpette® electronic handelt es sich um eine mikroprozessorgesteuerte, akkubetriebene Kolbenhubpipette nach dem Luftpolsterprinzip zum Pipettieren von wässrigen Lösungen mittlerer Dichte und Viskosität.

Bei richtiger Handhabung des Gerätes kommt die zu dosierende Probe nur mit der Spitze und nicht mit der Transferpette® electronic in Berührung.

## Einsatzgrenzen

Das Gerät dient zum Pipettieren von Proben unter Beachtung folgender Grenzen:

- Einsatztemperatur von +15 °C bis +40 °C (von 59 °F bis 104 °F) (von Gerät und Reagenz – andere Temperaturen auf Anfrage)
- Dampfdruck bis 500 mbar
- Viskosität: 260 mPa s

## Einsatzbeschränkungen

Viskose und benetzende Flüssigkeiten können die Genauigkeit des Volumens beeinträchtigen. Ebenso Flüssigkeiten, deren Temperatur mehr als  $\pm 5 \text{ °C} / 41 \text{ °F}$  von der Raumtemperatur abweicht.

## Einsatzausschlüsse

Der Anwender muss die Eignung des Geräts für den Verwendungszweck selbst überprüfen.

Das Gerät nicht zum Pipettieren von Flüssigkeiten einsetzen, die Polypropylen (Schaft & Spitzen) oder Polycarbonat/Polybutylenterephthalat (Gehäuse) oder EPDM (flexible Ersatz-Pipettenschäfte) angreifen. Aggressive Dämpfe meiden (Korrosionsgefahr)!

Das Griffteil ist nicht autoklavierbar.

## Akku- und Netzteil-Spezifikationen

### Akku

Nickel-Metallhydrid-Akku mit 3 zylindrischen Einzelzellen der Größe AAA, 3,6 V, 700 mAh

### Netzteil

Ausgangsspannung 6,5 V DC, 200 mA

# Die Bedienelemente

Die Transferpette® electronic ist eine auf Bedienungs-ergonomie und Arbeitserleichterung optimierte mikro-prozessorgesteuerte, akkubetriebene Kolbenhubpipette.

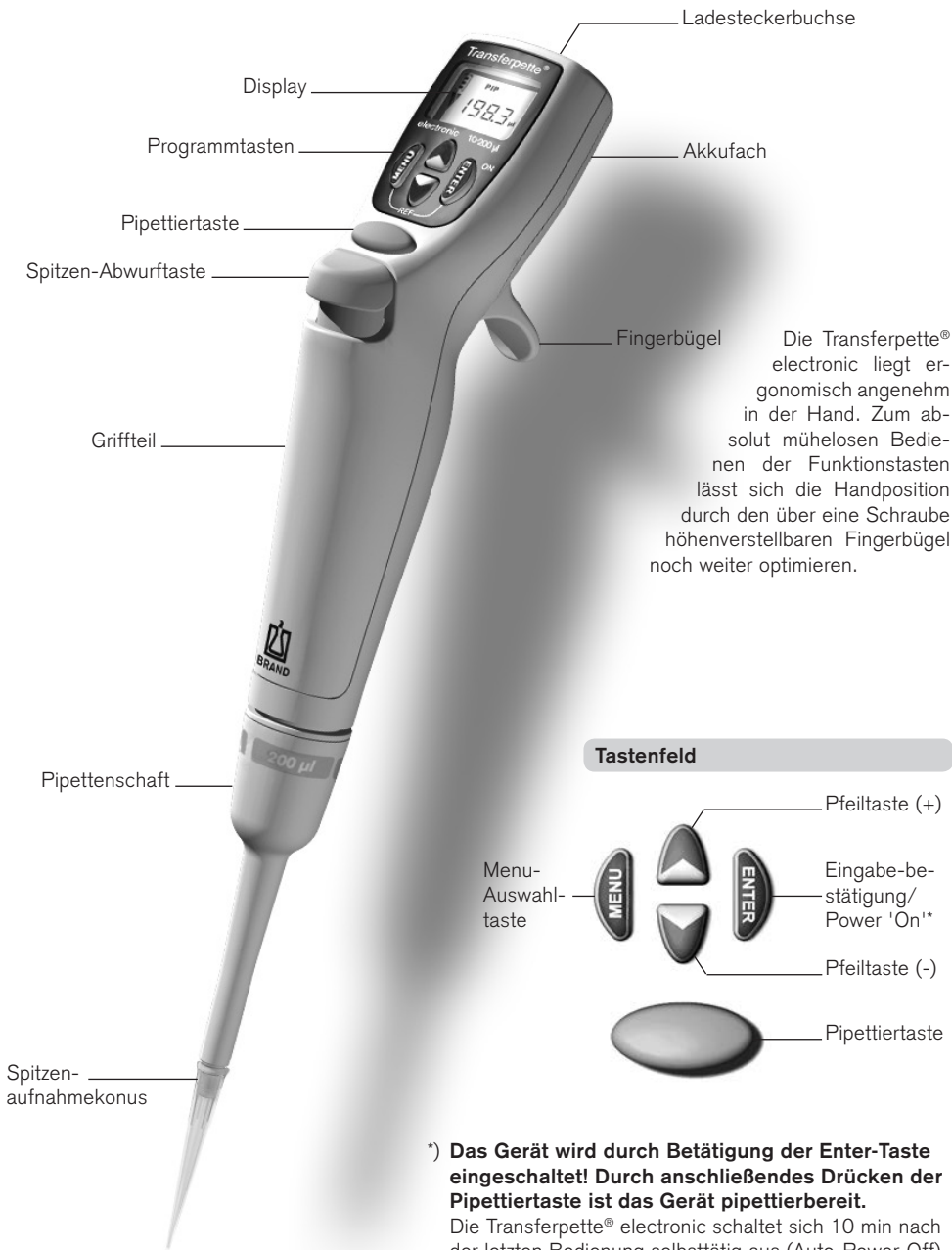

## Tastenfeld

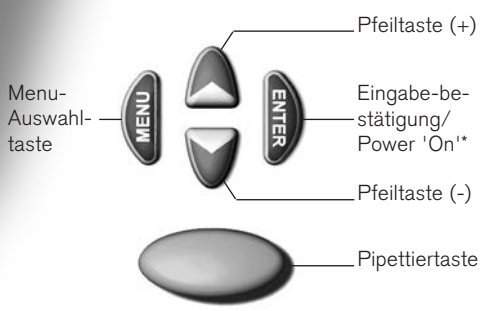

**\*) Das Gerät wird durch Betätigung der Enter-Taste eingeschaltet! Durch anschließendes Drücken der Pipettiertaste ist das Gerät pipettierbereit.**  
 Die Transferpette® electronic schaltet sich 10 min nach der letzten Bedienung selbsttätig aus (Auto-Power-Off).

## Ist alles in der Verpackung?

In der Verpackung befinden sich Ihre Transferpette® electronic, ein Akku, das Netzteil mit Akku-Ladekabel, Silikonöl, diese Gebrauchsanleitung sowie 1 Musterbeutel Pipettenspitzen.

### Inbetriebnahme der Transferpette® electronic

#### 1. Akku einsetzen

- Deckel des Akku-Fachs öffnen.
- Akku einlegen. Darauf achten, dass der Stecker des Akkus fest in die Buchse im Gerät eingesteckt wird.
- Deckel des Akku-Fachs wieder einsetzen und schließen.



#### 2. Gerät aktivieren

Die Transferpette® electronic fordert direkt nach dem Einsetzen des Akkus automatisch eine Referenzfahrt an. Nach dem Drücken der Pipettier-taste wird die Referenzfahrt durchgeführt und das Gerät ist pipettierbereit!



Das Display zeigt den werkseitig eingestellten Standard-Pipettiermodus (PIP) und das jeweilige Nennvolumen (hier z. B. 200,0 µl). Aufsaug- und Abgabegeschwindigkeit sind werkseitig maximal eingestellt. Die einfache Volumen- und Geschwindigkeitseinstellung ist auf den nachfolgenden Seiten beschrieben.

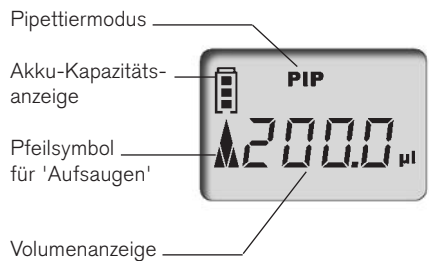

# Volumen einstellen

Das Volumen ist werkseitig auf das jeweilige Nennvolumen der Transferpette® electronic eingestellt und kann einfach und schnell individuell verändert werden.

Was muss ich tun?	Wie geht das?	Welche Taste?	Was zeigt das Display?
<b>1. Volumenauswahl aktivieren</b>	Durch Drücken einer der Pfeiltasten erfolgt die direkte Auswahl eines Volumens. 'VOL' blinkt.		
<b>2. Volumen einstellen</b>			
<b>verringern</b>	Durch Drücken der Pfeiltaste (-) wird das Volumen verringert. Anhaltendes Drücken der Pfeiltaste führt zur schnellen Volumenveränderung. 'VOL' blinkt weiterhin.		
<b>erhöhen</b>	Durch Drücken der Pfeiltaste (+) wird das Volumen erhöht. Anhaltendes Drücken der Pfeiltaste führt zur schnellen Volumenveränderung. 'VOL' blinkt weiterhin.		
<b>3. Volumenauswahl bestätigen</b>	Enter-Taste drücken. Das Display zeigt jetzt das neu eingestellte Volumen an, hier z. B. das Display des standardmäßig eingestellten PIP-Modus.		

## Wichtig:

Durch Betätigung der Menü-Taste kann jeder Einstellvorgang abgebrochen werden! Das Display springt dann zur nächsten Einstellmöglichkeit oder zur Ausgangsanzeige zurück.



# Aufsaug- und Abgabegeschwindigkeit einstellen

Aufsaug- und Abgabegeschwindigkeit sind separat einstellbar. Beim Menü-Aufruf wird die jeweils zuletzt eingestellte Geschwindigkeit angezeigt. 5 Geschwindigkeitsstufen stehen jeweils zur Verfügung.

Was muss ich tun?	Wie geht das?	Welche Taste?	Was zeigt das Display?
-------------------	---------------	---------------	------------------------

## Aufsauggeschwindigkeit einstellen

### 1. Menü aufrufen

Durch einmaliges, kurzes Drücken der Menü-Taste gelangt man in das Menü Aufsauggeschwindigkeit. 'Speed' blinkt.

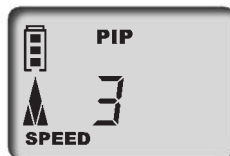

### 2. Aufsauggeschwindigkeit einstellen

Durch Betätigung der Pfeiltasten (+/-) wird die Geschwindigkeitsstufe ausgewählt (z. B. Stufe 5). 'Speed' blinkt weiterhin.

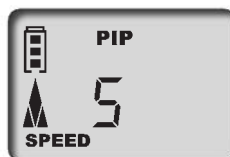

### 3. Geschwindigkeitsstufe bestätigen

Enter-Taste drücken. Das Display kehrt wieder in den Grundzustand des jeweils eingestellten Modus zurück, hier z. B. das Display des standardmäßigen PIP-Modus.



## Abgabegeschwindigkeit einstellen

### 1. Menü aufrufen

Durch zweimaliges, kurzes Drücken der Menü-Taste gelangt man in das Menü Abgabegeschwindigkeit. 'Speed' blinkt.

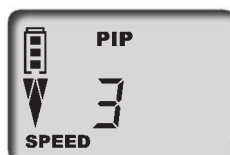

### 2. Abgabegeschwindigkeit einstellen

Durch Betätigung der Pfeiltasten (+/-) wird die Geschwindigkeitsstufe ausgewählt (z. B. Stufe 2). 'Speed' blinkt weiterhin.

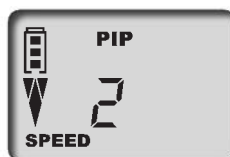

### 3. Geschwindigkeitsstufe bestätigen

Enter-Taste drücken. Das Display kehrt jetzt wieder in den Grundzustand des jeweils eingestellten Modus zurück, hier z. B. das Display des standardmäßigen PIP-Modus.



Das Volumen ist werkseitig auf das jeweilige Nennvolumen der Transferpette® electronic eingestellt und kann einfach und schnell individuell verändert werden (s. Seite 8).

## Quick Start im Standard-Pipettiermodus

### 1. Spitze aufstecken

Richtige Spitze entsprechend dem Volumenbereich bzw. Color-Code verwenden! Auf dichten und festen Sitz der Spitze achten. Bei Verwendung des flexiblen Pipettenschafts, falls nötig, alternativen Wechselclip aufstecken. Pipettenspitzen sind Einmalartikel!

### 2. Flüssigkeit aufnehmen



Gerät senkrecht halten und Spitze 2-3 mm in die Flüssigkeit eintauchen.

Durch Betätigung der Pipettiertaste wird die Flüssigkeit aufgesaugt. Der Pfeil im Display zeigt nach oben (Aufnahme).



**Hinweis:** Damit keine Luft angesaugt wird, Spitze noch ca. 1 s eingetaucht lassen.

### 3. Flüssigkeit abgeben

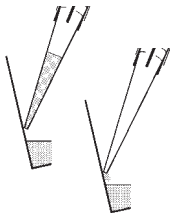

Nach Abschluss der Flüssigkeitsaufnahme zeigt der Pfeil im Display nach unten (Abgabe).

Pipettenspitze an Gefäßwand anlegen. Pipette im Winkel von 30-45° halten.

Durch erneute Betätigung der Pipettiertaste wird die Flüssigkeit vollständig mit automatischem Überhub abgegeben. Pipettenspitze dabei an der Gefäßwand abstreifen.



### 4. Spitze abwerfen



Pipettenschaft über einen geeigneten Entsorgungsbehälter halten und die Spitzenabwurf Taste niederdrücken.

Spitzenabwurf Taste



**Hinweis:**











Die ISO 8655 schreibt vor, die Pipettenspitze vor dem eigentlichen Pipettiervorgang einmal mit der Probenflüssigkeit vorzuspülen.

	Seite
<b>1. Normales Pipettieren</b>	
<b>PIP</b> -Modus _____	<b>12</b>
Standard-Programm. Ein zuvor eingegebenes Volumen wird aufgenommen und wieder abgegeben	
<b>2. Mischen von Proben</b>	
<b>PIPMix</b> -Modus _____	<b>14</b>
Programm zum Durchmischen von Flüssigkeiten. Probe wird ständig wiederholt aufgesaugt und abgegeben.	
<b>3. Reverses Pipettieren</b>	
<b>revPIP</b> -Modus _____	<b>16</b>
Programm besonders zum Pipettieren von Flüssigkeiten mit hoher Viskosität, hohem Dampfdruck oder schäumenden Medien.	
<b>4. Pipettieren bei Elektrophorese</b>	
<b>GEL</b> -Modus _____	<b>18</b>
Programm zum Beladen von Elektrophorese-Gelen. Ein vorher definiertes Probenvolumen wird bei hoher, veränderbarer Geschwindigkeit aufgesaugt und langsam wieder abgegeben.	
<b>5. Dispensieren</b>	
<b>DISP</b> -Modus _____	<b>20</b>
Programm zum Dispensieren von Flüssigkeiten. Ein aufgenommenes Volumen wird in Teilschritten wieder abgegeben.	



Der GEL-Modus ist bei der Transferpette® electronic 1000 µl und 5000 µl nicht verfügbar.



Das Standard-Programm – ein zuvor eingegebenes Volumen wird aufgenommen und wieder abgegeben.

Volumen- und Geschwindigkeitseinstellung wie auf Seite 8/9 beschrieben.

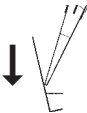
Was muss ich tun?	Wie geht das?	Welche Taste?	Was zeigt das Display?
<b>1. Menü-Selektion aufrufen</b>	Durch dreimaliges Drücken der Menü-Taste gelangt man in die Programm-Selektion. <b>'Mode'</b> blinkt.	3x 	
<b>2. PIP-Modus einstellen</b>	Mit einer der Pfeiltasten die Modi durchscrollen bis <b>'PIP'</b> erscheint. <b>'Mode'</b> blinkt weiterhin.		
<b>3. PIP-Modus bestätigen</b>	Enter-Taste drücken. Das Display zeigt jetzt <b>'blo'</b> für blow-out (Überhub).	 1x	
<b>4. Vorbereiten zum Pipettieren</b>	Durch einmaliges Drücken der Pipettiertaste wird der Kolben in seine Startposition gefahren. Der Pfeil im Display zeigt nach oben (Aufnahme).	 1x	
<b>5. Flüssigkeit aufsaugen</b>	Zum Aufsaugen der Flüssigkeit Pipettiertaste einmal drücken.	 1x	







Was muss ich tun?	Wie geht das?	Welche Taste?	Was zeigt das Display?
<p><b>6. Flüssigkeit abgeben</b></p> 	<p>Durch einmaliges Drücken der Pipettiertaste erfolgt die Abgabe der Flüssigkeit. Der Pfeil im Display zeigt nach unten (Abgabe).</p>		

<p><b>7. Überhub auslösen?</b></p>	<p><b>Sie müssen nichts tun!</b> Beim Pipettieren im PIP-Modus erfolgt der <b>Überhub (blow-out) automatisch!</b></p>		
------------------------------------	---	---	--

## Blow-out direkt auslösen

Der Überhub (Blow-out) kann, wenn nötig, jederzeit auch direkt ausgelöst werden.

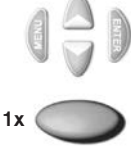





























<p><b>1. Blow-out-Funktion aufrufen</b></p>	<p>Enter-Taste drücken. Das Display zeigt 'blo' für blow-out.</p>		
---	---	--	---

<p><b>2. Überhub auslösen</b></p>	<p>Durch einmaliges Drücken der Pipettiertaste wird der Überhub ausgelöst und das Display springt in den eingestellten Pipettier-Modus (Startposition) zurück.</p>		
-----------------------------------	--	---	--

**Hinweis:**

Beim Überhub (blow-out) bewegt sich der Kolben vollständig nach unten. Es ist sicherzustellen, dass mögliche Restflüssigkeit gefahrlos abgegeben wird. **Gedrückt halten der Pipettiertaste hält den Kolben unten und verhindert somit ein versehentliches Aufsaugen von Flüssigkeit. Loslassen bewirkt die Rückkehr des Kolbens in die Startposition.**

Programm zum Durchmischen von Flüssigkeiten.  
 Probe wird ständig wiederholt aufgesaugt und abgegeben.  
 Volumen- und Geschwindigkeitseinstellung wie auf Seite 8/9 beschrieben.

Was muss ich tun?	Wie geht das?	Welche Taste?	Was zeigt das Display?
<b>1. Menü-Selektion aufrufen</b>	Durch dreimaliges Drücken der Menü-Taste gelangt man in die Programm-Selektion. 'Mode' blinkt.	3x     	
<b>2. PIPmix-Modus einstellen</b>	Mit einer der Pfeiltasten die Modi durchscrollen bis 'PIPmix' erscheint. 'Mode' blinkt weiterhin.	    	
<b>3. PIPmix-Modus bestätigen</b>	Enter-Taste drücken. Das Display zeigt jetzt 'blo' für blow-out (Überhub).	    1x 	
<b>4. Vorbereiten zum Pipettieren</b>	Durch einmaliges Drücken der Pipettiertaste wird der Kolben in seine Startposition gefahren. Der Pfeil auf dem Display zeigt nach oben (Aufnahme).	    1x 	
<b>5. Flüssigkeit aufsaugen</b>	Zum Aufsaugen der Flüssigkeit Pipettiertaste einmal drücken.	    1x 	

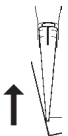

Was muss ich tun?

Wie geht das?

Welche Taste?

Was zeigt das Display?

**6. Flüssigkeit im PIPmix-Modus abgeben**

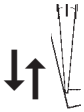

Durch anhaltendes Drücken der Pipettiertaste erfolgt die wechselnde Abgabe und Aufnahme der Flüssigkeit. Im Display werden abwechselnd das Pfeilsymbol für Aufnahme bzw. Abgabe, sowie die Anzahl der Zyklen angezeigt.



**7. Pipettieren beenden**































Durch einmaliges Drücken der Pipettiertaste wird die Flüssigkeit abgegeben und der Überhub (blow-out) ausgelöst.

Nach der Abgabe der Restflüssigkeit (Überhub) springt das Display in den eingestellten Modus (Startposition) zurück.









**Hinweis:** Das Display zeigt maximal 19 Zyklen an.

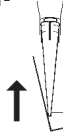
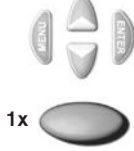



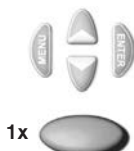





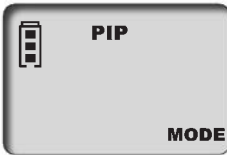

Programm besonders zum Pipettieren von Flüssigkeiten mit hoher Viskosität, Dampfdruck oder schäumenden Medien.  
 Volumen- und Geschwindigkeitseinstellung wie auf Seite 8/9 beschrieben.











Was muss ich tun?	Wie geht das?	Welche Taste?	Was zeigt das Display?
<b>1. Menü-Selektion aufrufen</b>	Durch dreimaliges Drücken der Menü-Taste gelangt man in die Programm-Selektion. <b>'Mode'</b> blinkt.	3x    	
<b>2. revPIP-Modus einstellen</b>	Mit einer der Pfeiltasten die Modi durchscrollen bis <b>'revPIP'</b> erscheint. <b>'Mode'</b> blinkt weiterhin.	   	
<b>3. revPIP-Modus bestätigen</b>	Enter-Taste drücken. Das Display zeigt jetzt <b>'blo'</b> für blow-out (Überhub).	   1x 	
<b>4. Vorbereiten zum Pipettieren</b>	Durch einmaliges Drücken der Pipettiertaste wird der Kolben in seine Startposition gefahren. Der Pfeil im Display zeigt nach oben (Aufnahme).	   1x 	
<b>5. Flüssigkeit aufsaugen</b>	Pipettiertaste einmal drücken, dabei wird etwas mehr Volumen aufgenommen als eingestellt!	   1x 	
<b>6. Flüssigkeit im revPIP-Modus abgeben</b>	Zur Abgabe einmal Pipettiertaste drücken. Auf dem Display zeigt der Pfeil nach unten (Abgabe). Jetzt wird das eingestellte Volumen abgegeben und es verbleibt etwas Flüssigkeit in der Spitze.	   1x 	

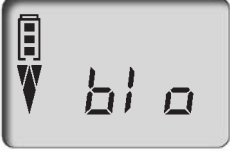

Was muss ich tun?	Wie geht das?	Welche Taste?	Was zeigt das Display?
<p>7. Flüssigkeit im revPIP-Modus erneut aufnehmen</p> 	<p>Durch erneutes Drücken der Pipettiertaste wird jetzt das eingestellte Volumen wieder aufgenommen. (Nochmaliges Drücken der Pipettiertaste gibt das Volumen wieder ab, usw.)</p>		
<p>8. Überhub auslösen</p>	<p>Nach der letzten Pipettierung Enter-Taste drücken. Das Display zeigt jetzt wieder 'blo' für blow-out (Überhub).</p>		
	<p>Durch einmaliges Drücken der Pipettiertaste wird der Überhub (blow-out) ausgelöst und die Restflüssigkeit abgegeben.</p>		
<p>9. Pipettieren beenden</p>	<p>Nach der Abgabe der Restflüssigkeit (Überhub) springt das Display in den eingestellten Modus (Startposition) zurück.</p>		

Programm zum Beladen von Elektrophorese-Gelen. Ein vorher definiertes Probenvolumen wird bei hoher, veränderbarer Geschwindigkeit aufgesaugt und langsam wieder abgegeben. Volumen- und Geschwindigkeitseinstellung wie auf Seite 8/9 beschrieben.













Was muss ich tun?	Wie geht das?	Welche Taste?	Was zeigt das Display?
<b>1. Menü-Selektion aufrufen</b>	Durch dreimaliges Drücken der Menü-Taste gelangt man in die Programm-Selektion. <b>'Mode'</b> blinkt.	3x 	
<b>2. GEL-Modus einstellen</b>	Mit einer der Pfeiltasten Modi durchscrollen bis <b>'GEL'</b> erscheint. <b>'Mode'</b> blinkt weiterhin.		
<b>3. GEL-Modus bestätigen</b>	Enter-Taste drücken. Das Display zeigt jetzt <b>'blo'</b> für blow-out (Überhub).	 1x	
<b>4. Vorbereiten zum Pipettieren</b>	Durch einmaliges Drücken der Pipettiertaste wird der Kolben in seine Startposition gefahren. Der Pfeil im Display zeigt nach oben (Aufnahme).	 1x	
<b>5. Flüssigkeit aufnehmen</b>	Zum Aufsaugen der Flüssigkeit Pipettiertaste einmal drücken. Das eingestellte Volumen wird aufgesaugt.	 1x	
	<b>Höheres Volumen aufnehmen</b> Um mehr Flüssigkeit aufzusaugen als eingestellt (bis max. 110% des Nennvolumens), Pipettiertaste während des Aufsaugvorgangs so lange gedrückt halten, bis gewünschtes Volumen aufgesaugt wurde. Im Display wird eine Raute angezeigt.	 gedrückt halten	











Was muss ich tun?	Wie geht das?	Welche Taste?	Was zeigt das Display?
<b>6. Flüssigkeit im GEL-Modus abgeben</b> 	<p>Zur Abgabe einmal Pipettiertaste kurz drücken. Im Display wird eine Raute angezeigt. Das aufgenommene Volumen wird langsam wieder abgegeben.</p> <p><b>Abgabe unterbrechen</b>                      Die Abgabe der Probe kann durch nochmaliges Drücken der Pipettiertaste unterbrochen werden. Dabei zeigt das Display das Volumen der abgegebenen Flüssigkeitsmenge an.</p>	 1x 	
<b>7. Überhub auslösen</b>	<p>Nach der letzten Pipettierung Enter-Taste drücken. Das Display zeigt jetzt wieder 'blo' für blow-out (Überhub).</p> <p>Durch einmaliges Drücken der Pipettiertaste wird der Überhub (blow-out) ausgelöst und die Restflüssigkeit abgegeben.</p>	 1x 	
<b>8. Pipettieren beenden</b>	<p>Nach der Abgabe der Restflüssigkeit (Überhub) springt das Display in den eingestellten Modus (Startposition) zurück.</p>	 1x 	

**Hinweis:**

Der GEL-Modus verlangt sehr langsame Abgabegeschwindigkeiten um Verwirbelungen der Proben vorzubeugen. Um eine optimale Abgabe zu gewährleisten, ist die Abgabegeschwindigkeit werkseitig festgelegt. Sie ist deutlich langsamer als die einstellbare Stufe 1 und individuell nicht anwählbar.

Programm zur Abgabe einer aufgenommenen Flüssigkeit in Teilschritten.  
 Es wird etwas mehr Flüssigkeit aufgenommen als rechnerisch nötig.  
 Geschwindigkeitseinstellung wie auf Seite 9 beschrieben.

Was muss ich tun?	Wie geht das?	Welche Taste?	Was zeigt das Display?
1. Menü-Selektion aufrufen	Durch dreimaliges Drücken der Menü-Taste gelangt man in die Programm-Selektion. 'Mode' blinkt.	3x 	
2. DISP-Modus einstellen	Mit einer der Pfeiltasten die Modi durchscrollen bis 'DISP' erscheint. 'Mode' blinkt weiterhin.		
3. DISP-Modus bestätigen	Enter-Taste drücken. Das Display zeigt jetzt 'blo' für blow-out (Überhub).	 1x	
4. Vorbereiten zum Dispensieren	Durch einmaliges Drücken der Pipettiertaste wird der Kolben in seine Startposition gefahren. Der Pfeil im Display zeigt nach oben (Aufnahme).	 1x	
5. Teilvolumen einstellen	Durch Drücken der Pfeiltaste (+/-) wird das Volumen eingestellt. Anhaltendes Drücken der Pfeiltaste führt zur schnellen Volumenveränderung. 'VOL' blinkt.		
6. Teilvolumen bestätigen	Enter-Taste drücken. Das Display zeigt das neu eingestellte Teilvolumen an. 'steps' blinkt. Es wird die maximal mögliche Anzahl der Steps angezeigt.	 1x	

Was muss ich tun?	Wie geht das?	Welche Taste?	Was zeigt das Display?
<b>7. Anzahl Steps einstellen</b>	Durch Drücken der Pfeiltaste (+/-) wird die Anzahl der Steps eingestellt. 'steps' blinkt weiterhin.		
<b>8. Anzahl Steps bestätigen</b>	Enter-Taste drücken. Das Display zeigt die eingestellte Anzahl der Steps an.		
<b>9. Flüssigkeit aufsaugen</b>	Zum Aufsaugen der Flüssigkeit Pipettiertaste einmal drücken.		
<b>10. Flüssigkeit abgeben</b>	Mit jedem Betätigen der Pipettiertaste erfolgt ein Dispensierschritt. Der Pfeil im Display zeigt nach unten (Abgabe). Die Step-Anzeige zeigt die Anzahl der verbleibenden Schritte.		
<b>11. Überhub auslösen</b>	Nach dem letzten Dispensierschritt Enter-Taste drücken. Das Display zeigt 'blo' für blow-out (Überhub). Anschließendes einmaliges Drücken der Pipettiertaste löst Überhub aus (s. auch S. 19).		
<b>12. Dispensieren beenden</b>	Nach der Abgabe der Restflüssigkeit (Überhub) springt das Display in den eingestellten Modus (Startposition) zurück.		

# Volumen kontrollieren

Wir empfehlen, je nach Einsatz, alle 3-12 Monate eine Prüfung des Gerätes. Der Zyklus kann aber den individuellen Anforderungen angepasst werden.

Die gravimetrische Volumenprüfung der Pipette erfolgt durch nachfolgende Schritte und entspricht der DIN EN ISO 8655, Teil 6.

## 1. Nennvolumen einstellen

Maximales angegebenes Gerätevolumen einstellen.  
Vorgehensweise siehe Seite 8.

## 2. Pipette konditionieren

Pipette vor der Prüfung konditionieren, indem mit einer Pipettenspitze fünfmal die Prüflüssigkeit (H<sub>2</sub>O dest.) aufgenommen und abgegeben wird. Danach die Pipettenspitze abwerfen.

## 3. Prüfung durchführen

- Neue Pipettenspitze aufstecken und einmal mit Prüflüssigkeit vorspülen.
- Prüflüssigkeit aufnehmen und in das Wägegefäß pipettieren.
- Pipettierte Menge mit einer Analysenwaage wägen. (Beachten Sie bitte die Gebrauchsanleitung des Waagenherstellers.)
- Pipettiertes Volumen berechnen. Dabei die Temperatur berücksichtigen.
- Mindestens 10 Pipettierungen und Wägungen in 3 Volumenbereichen (100 %, 50 %, 10 %) werden empfohlen.

### Berechnung (für Nennvolumen)

$x_i$  = Wäge-Ergebnisse  
 $n$  = Anzahl der Wägungen

$Z$  = Korrekturfaktor  
(z. B. 1,0029 µl/mg bei 20 °C, 1013 hPa)

Mittelwert  $\bar{x} = \frac{\sum x_i}{n}$

Mittleres Volumen  $\bar{V} = \bar{x} \cdot Z$

### Richtigkeit\*

$$R\% = \frac{\bar{V} - V_0}{V_0} \cdot 100$$

$V_0$  = Nennvolumen

### Standardabweichung

$$s = Z \cdot \sqrt{\frac{\sum (x_i - \bar{x})^2}{n - 1}}$$

### Variationskoeffizient\*

$$VK\% = \frac{100 \cdot s}{\bar{V}}$$

\*) = Berechnung von Richtigkeit (R%) und Variationskoeffizient (VK%):  
R% und VK% werden nach den Formeln der statistischen Qualitätskontrolle berechnet.

Endprüfwerte bezogen auf das auf dem Gerät aufgedruckte Nennvolumen (= max. Volumen) und die angegebenen Teilvolumina bei gleicher Temperatur (20 °C/68 °F) von Gerät, Umgebung und aqua dest. Gemäß der DIN EN ISO 8655.



## Genauigkeitswerte der Transferpette® electronic

Volumenbereich µl	Teilvolumen µl	R* ≤ ± %	VK* ≤ %	Teilschritte µl	Empfohlener Spitzentyp, µl
0,5 - 10	10	1,0	0,4	0,01	0,5 - 20
	5	1,5	0,8		
	1	5,0	2,0		
2 - 20	20	1,0	0,4	0,02	0,5 - 20
	10	1,5	0,8		
	2	5,0	2,5		
10 - 200	200	0,8	0,2	0,2	2 - 200
	100	1,2	0,3		
	20	4,0	0,6		
50 - 1000	1000	0,6	0,2	1,0	50 - 1000
	500	1,0	0,3		
	100	3,0	0,6		
250 - 5000	5000	0,6	0,2	5,0	500 - 5000
	2500	1,0	0,3		
	500	3,0	0,6		

\* R = Richtigkeit, VK = Variationskoeffizient

### Hinweis:

Das Gerät ist gemäß dem Mess- und Eichgesetz sowie der Mess- und Eichverordnung gekennzeichnet:

**DE-M** 19

Zeichenfolge DE-M (DE für Deutschland), eingerahmt durch ein Rechteck, sowie die beiden letzten Ziffern des Jahres, in dem die Kennzeichnung angebracht wurde (hier: 2019).

### Hinweis:

Prüfanweisungen (SOPs) und eine Demoversion der Kalibriersoftware EASYCAL™ 4.0 stehen unter [www.brand.de](http://www.brand.de) zum Download bereit.

## Der Justier-Modus 'CAL'

### Justieren

Das Nennvolumen bzw. zu prüfendes Volumen ist eingestellt, Standard-Modus Pipettieren (PIP), z. B. 200,0 µl (Vorgehensweise siehe Seite 8, 12).

Bsp.: Volumen entsprechend Volumenprüfung 201,3 µl.



#### Was muss ich tun?

#### Wie geht das?

#### Welche Taste?

#### Was zeigt das Display?

### 1. CAL-Modus aufrufen

Durch anhaltendes Drücken (> 3 Sek.) der Menü-Taste wird der CAL-Modus aufgerufen. Die Anzeige zeigt 'off'. 'CAL' blinkt.

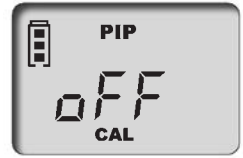
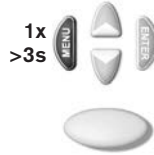

### 2. CAL-Modus aktivieren

Durch Drücken einer der Pfeiltasten wird der CAL-Modus aktiviert. Die Anzeige wechselt von 'off' auf 'on'. 'CAL' blinkt weiterhin.

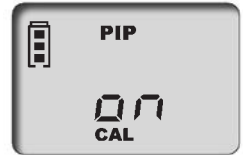

### 3. CAL-Modus bestätigen

Enter-Taste drücken. Das Display zeigt jetzt wieder das eingestellte Pipettiervolumen. 'CAL' blinkt.



### 4. Volumen einstellen

Mit den Pfeiltasten (+/-) das vorher ermittelte und geprüfte Volumen einstellen. 'CAL' blinkt.



### 5. Volumen bestätigen

Enter-Taste drücken. Im Display erscheint das geprüfte und korrigierte Volumen. Das jetzt ständig angezeigte CAL-Symbol belegt die vorgenommene Justierung.





## Werkzustand wieder herstellen

Das ständig angezeigte CAL-Symbol im Display weist auf eine vorgenommene Justierung hin.



**Was muss ich tun?**

**Wie geht das?**

**Welche Taste?**

**Was zeigt das Display?**

### 1. CAL-Modus aufrufen

Durch anhaltendes Drücken (> 3 Sek.) der Menü-Taste wird der CAL-Modus aufgerufen. Die Anzeige zeigt 'on'. 'CAL' blinkt.

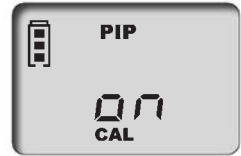
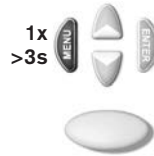

### 2. CAL-Modus ausschalten

Durch Drücken einer der Pfeiltasten wird der CAL-Modus deaktiviert. Die Anzeige wechselt von 'on' auf 'off'. 'CAL' blinkt weiterhin.



### 3. Werkzustand herstellen

Enter-Taste drücken. Das ständig angezeigte CAL-Symbol ist verschwunden. Das Gerät befindet sich wieder im Werkzustand.



## Wichtig:

Bei der Transferpipette® electronic wird beim Justieren ein Volumen-Offset vorgenommen, d. h. das Volumen ändert sich über den gesamten Volumenbereich der Pipette um den gleichen Betrag. Es wird empfohlen, die Justierung bei 50 % des Nennvolumens durchzuführen.

## Hinweis:

Das Gerät ist permanent justiert für wässrige Lösungen, kann aber auch auf Lösungen unterschiedlicher Dichte, Viskosität und Temperatur eingestellt werden. Die Transferpipette® electronic kann in jedem Modus justiert werden (Ausnahme GEL-Modus).

# Autoklavieren

Der hervorgehoben abgebildete Pipettenschaft der Transferpette® electronic ist autoklavierbar bei 121 °C (250 °F), 2 bar und einer Haltezeit von mindestens 15 Minuten nach DIN EN 285.

**Achtung:** Das Griffteil ist nicht autoklavierbar!

1. Pipettenspitze abwerfen.
2. Pipettenschaft vom Griffteil abschrauben.
3. Ohne weitere Demontage kompletten Pipettenschaft autoklavieren.
4. Pipettenschaft vollständig abkühlen und trocknen lassen.
5. Pipettenschaft wieder in das Griffteil schrauben.
6. Referenzfahrt (rEF) durchführen.

**Hinweis:** Die Wirksamkeit des Autoklavierens ist vom Anwender selbst zu prüfen. Höchste Sicherheit wird durch Vakuumsterilisation erreicht. Wir empfehlen die Verwendung von Sterilisationsbeuteln.

Bei häufigem Autoklavieren des Pipettenschaftes sollten Kolben und Dichtung zur besseren Gängigkeit mit dem mitgelieferten Silikonfett eingefettet werden.



## Referenzfahrt (rEF)

Nach jedem Wechsel des Pipettierschaftes ist eine manuelle Referenzfahrt durchzuführen. Die Referenzfahrt dient zur sicheren Ankopplung des Kolbens.

Was muss ich tun?	Wie geht das?	Welche Taste?	Was zeigt das Display?
1. rEF-Modus aufrufen	Durch gleichzeitiges Drücken der Menü- und der Enter-Taste wird der rEF-Modus aktiviert.		
2. Referenzfahrt durchführen	Durch einmaliges Drücken der Pipettiertaste wird die Referenzfahrt ausgelöst. Ein deutliches Funktionsgeräusch ist vernehmbar.		

**Hinweis:** Nach der Referenzfahrt schaltet das Display automatisch in das vorher eingestellte Programm zurück.

Die Transferpette® electronic sollte, um eine einwandfreie Funktion zu gewährleisten, in regelmäßigen Abständen gewartet und ggf. gereinigt werden.

### Wartung

Pipettenaufnahmekonus auf Beschädigung prüfen.  
 Kolben und Dichtung auf Verschmutzung untersuchen.  
 Dichtheit des Geräts prüfen. Wir empfehlen das BRAND Dichtheitsprüfgerät BRAND PLT unit zu verwenden.  
 Alternativ dazu Probe aufsaugen, Gerät ca. 10 s senkrecht halten. Falls sich an der Pipettenspitze ein Tropfen bildet: Störung – was tun?, Seite 31.

### Demontage und Reinigung

1. Pipettenschaft (S) vom Griffteil durch Abschrauben lösen.
  2. Durch Ziehen die magnetische Verbindung beider Komponenten trennen.
  3. Abwerferoberteil (A) aus dem Pipettenschaft herausschrauben.
  4. Schaft (D u. B) aus dem Abwerferunterteil (E) herausziehen.
  5. Rückhaltehülse (B) herausschrauben.
- Hinweis:** Kolben mit Kolbenführung bleiben mit Rückhaltehülse (B) verbunden!
6. Feder mit Dichtung (C) entnehmen.
  7. Abgebildete Teile mit Seifenlösung oder Isopropanol reinigen, anschließend mit aqua dest. spülen.
  8. Teile trocknen (max. 120°C/248 °F).
  9. Kolben hauchdünn nachfetten.
  10. Abgekühlte Teile wieder in umgekehrter Reihenfolge montieren. Rückhaltehülse und Abwerferoberteil (A, B) nur handfest anziehen.
  11. Referenzfahrt (rEF) durchführen.

**Hinweis:** Sämtliche gezeigten Einzelkomponenten können als Ersatzteile bezogen werden (Bestelldaten s. Seite 33).

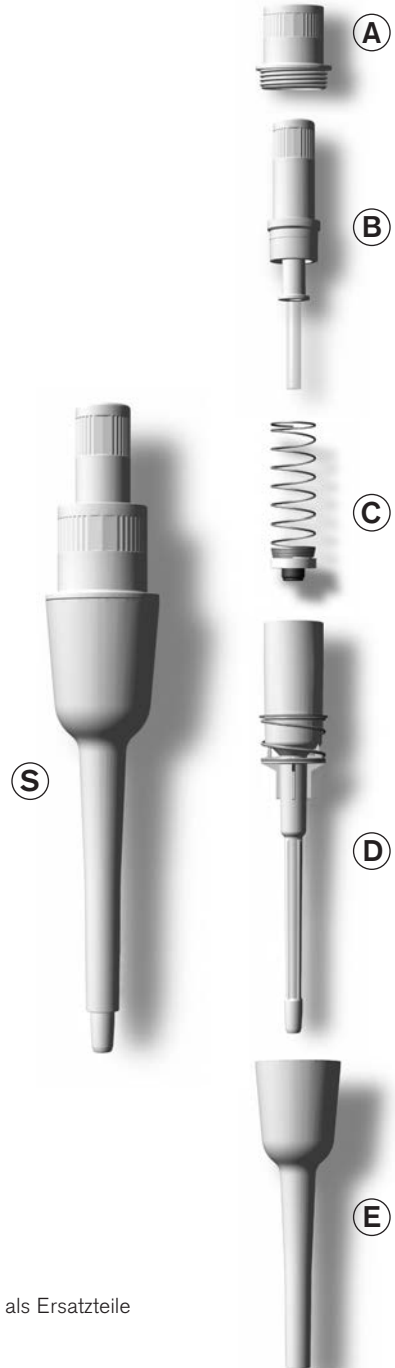

Die Transferpette® electronic sollte, um eine einwandfreie Funktion zu gewährleisten, in regelmäßigen Abständen gewartet und ggf. gereinigt werden.

## Wartung

Pipettenaufnahmekonus auf Beschädigung prüfen.  
 Kolben und Dichtung auf Verschmutzung untersuchen.  
 Dichtheit des Geräts prüfen. Wir empfehlen das BRAND Dichtheitsprüfgerät BRAND PLT unit zu verwenden.  
 Alternativ dazu Probe aufsaugen, Gerät ca. 10 s senkrecht halten. Falls sich an der Pipettenspitze ein Tropfen bildet: Störung – was tun?, Seite 31.

## Demontage und Reinigung

1. Seitliche Verschlüsse (J) gleichzeitig drücken und Abwerferunterteil (G') abziehen.
  2. Pipettenschaft (H+I) vom Griffteil durch Abschrauben lösen.
  3. Durch Ziehen die magnetische Verbindung beider Komponenten trennen und Abwerferoberenteil (G) abnehmen.
  4. Kolbeneinheit (H) und Schaftunterteil (I) auseinander schrauben.
  5. O-Ring von Kolbeneinheit abziehen und reinigen.
- Hinweis:** Die Kolbeneinheit (H) nicht weiter demontieren!
6. Kolbeneinheit (H) und Schaftunterteil (I) mit Seifenlösung oder Isopropanol reinigen, anschließend mit aqua dest. spülen.
  7. Teile trocknen (max. 120 °C/248 °F) und abkühlen lassen.
  8. O-Ring sorgfältig innen und außen fetten und auf Kolben aufziehen.
  9. Die Einzelkomponenten wieder in umgekehrter Reihenfolge montieren.
  10. Anschließend Referenzfahrt (rEF) durchführen.

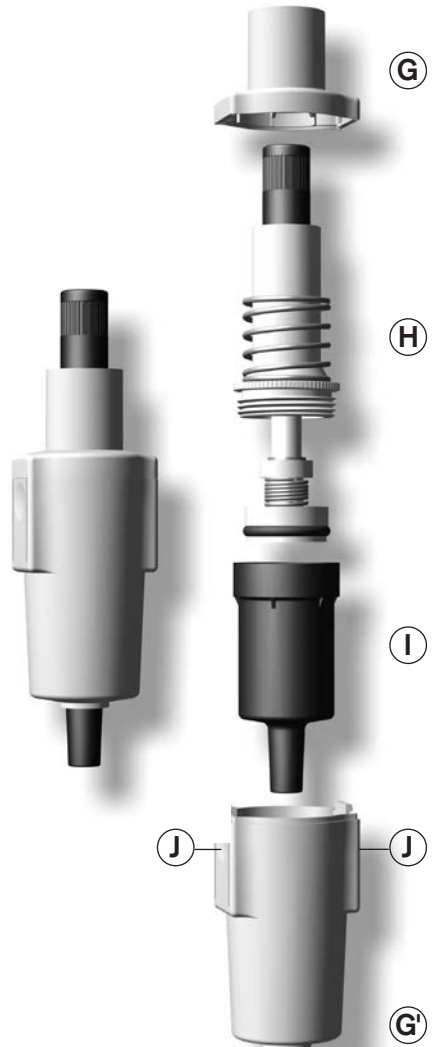

**Hinweis:** Die gezeigten Einzelkomponenten können als Ersatzteile bezogen werden (Bestelldaten s. Seite 33).

Ein vollständig geladener Akku erlaubt ca. 8 h Dauerpipettieren (über 4000 Pipettierzyklen) von Proben wasserähnlicher Viskosität und Dichte.

## Achtung!

Vor dem Laden ist sicherzustellen, dass das Netzteil für die im Labor vorhandene Spannung geeignet ist. Das Gerät darf nicht in explosionsgefährdeter Umgebung geladen werden. Der Akku kann ausschließlich in der Transferpette® electronic geladen werden!

## Akku nachladen

- Ladekabelstecker des Netzteils in die dafür vorgesehene Buchse oben an der Transferpette® electronic stecken. Der Ladevorgang startet automatisch.
- Während des Ladevorgangs laufen die Balken der Akku-Kapazitätsanzeige ständig von unten nach oben. Der Akku ist vollständig geladen, wenn die Balken der Anzeige zum Stillstand gekommen sind.

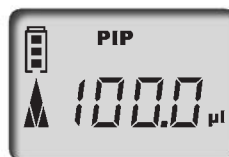

## Pipettieren während des Ladevorgangs?

Während des Ladens kann mit der Transferpette® electronic weiter gearbeitet werden. Bei vollständig entladenerm Akku dauert es einige Minuten bis eine bestimmte Mindestladekapazität erreicht ist, die zum sicheren Betrieb des Geräts notwendig ist.

## Hinweis:

Die zuletzt vorgenommenen Einstellungen werden im EEPROM des Geräts gespeichert. Bei kompletter Entladung oder beim Wechsel des Akkus bleiben diese Einstellungen gesichert!

## Akku auswechseln

- Deckel des Akku-Fachs öffnen, Akku entnehmen und Stecker aus der Steckbuchse ziehen.
- Stecker von neuem Akku in die Steckbuchse stecken und neuen Akku einlegen.
- Deckel des Akku-Fachs wieder einsetzen und verschließen.



Bei längeren Betriebspausen Akku aus dem Gerät entfernen.

## Akku laden und wechseln

### Batterieanzeige nach erneutem Einsetzen eines Akkus

- a) Nach dem Einsetzen eines Akkus erscheint **im Display die volle Kapazitätsanzeige** mit blinkendem Rahmen (das Gerät erkennt den Ladezustand zunächst noch nicht). Nach 3,5 h Ladezeit – sicheres vollständiges Laden des Akkus – hört der Rahmen auf zu blinken.



#### Hinweis:

Nach dem Einsetzen eines Akkus immer 3,5 h laden!  
Die vollständige Ladekapazität wird nach mehreren Lade-/Entladezyklen erreicht!

## Akku-Regenerationsfunktion

### (Refresh-Funktion)

Zur Verlängerung der Lebensdauer und zur Leistungssteigerung der Akkus verfügt die Transferpette® electronic über eine Regenerationsfunktion (Refresh-Funktion). Diese Funktion ermöglicht es, die Akkus programmgesteuert vollständig ent- und wieder aufzuladen. Zur Optimierung der Leistungsfähigkeit der Akkus sollte die Refresh-Funktion von Zeit zu Zeit angewendet werden.

### Refresh-Funktion durchführen

- a) Ladekabelstecker (Anschluss) des Netzteils in die dafür vorgesehene Buchse oben an der Transferpette® electronic stecken.



- b) Untere Pfeiltaste länger als 3 s drücken. Während des Entladens laufen die Kapazitätsbalken der Batterieanzeige ständig von oben nach unten.







- c) Nach dem Entladen (bis 3 h) wird automatisch der Ladevorgang (3,5 h) gestartet. Während des Ladens laufen die Kapazitätsbalken der Batterieanzeige ständig von unten nach oben.



### Abbruch der Refresh-Funktion

Durch Drücken einer beliebigen Taste wird das Programm beendet. Das Gerät schaltet automatisch in den Standard-Pipettiermodus (PIP) und auf das Nennvolumen zurück und der normale Ladevorgang wird automatisch gestartet (s. Seite 29). Ziehen des Netzteilsteckers beendet das Programm ebenfalls. Der Abbruch der Refresh-Funktion darf nicht am Ende des Entladezyklus vorgenommen werden.

Beim Auftreten eines Fehlers zeigt das Gerät im Display 'Err' und die Fehlernummer an. Das Gerät reagiert dann nur noch auf die Enter-Taste. Durch Betätigen der Enter-Taste wird versucht, das Gerät neu zu starten. Es wird daher automatisch eine Referenzfahrt (rEF) angefordert.

Störung	Error-Anzeige im Display	Mögliche Ursache	Was tun?
Gerät reagiert nicht		Akku leer oder defekt	Akku mind. 5 min ohne Betätigung laden, dann nur mit Ladekabel weiterarbeiten bis Akku nachgeladen ist, ggf. Akku austauschen
		elektronische Bauteile defekt	Gerät zur Reparatur einsenden
Gerät reagiert nicht		elektronische Bauteile defekt	Gerät zur Reparatur einsenden
Gerät reagiert nicht		unvorhergesehener Programmfehler	Fehlerbestätigung durch Betätigen der Enter-Taste, Gerät wird neu initialisiert
Gerät reagiert nicht		kein Akku im Gerät	Akku einsetzen
		Akku defekt	Akku austauschen
		elektronische Bauteile defekt	Gerät zur Reparatur einsenden
Spitze tropft/ Gerät undicht oder Volumenfehler	—	ungeeignete Spitze	nur Qualitätsspitzen verwenden
		Spitze sitzt nicht fest	Spitze fester aufdrücken/ anderer Wechselclip
		Kolben, Schaft oder Dichtung verschmutzt oder beschädigt	Gerät reinigen/ Dichtung ersetzen, Kolben fetten
Keine Anzeige im Display		elektrostatische Entladung	Akku entfernen und erneut einsetzen
		elektronische Bauteile defekt	Gerät zur Reparatur einsenden

## Transferpette® electronic

Volumen	0,5-10 µl	2-20 µl	10-200 µl	50-1000 µl	250-5000 µl
<b>mit Netzteil (110-240V/50-60 Hz)</b>	Best.-Nr.	Best.-Nr.	Best.-Nr.	Best.-Nr.	Best.-Nr.
für Europa (Kontinent)	7052 99	7053 00	7053 03	7053 06	7053 07
für UK/Irland	7053 09	7053 10	7053 13	7053 16	7053 17
für USA/Japan	7053 19	7053 20	7053 23	7053 26	7053 27
für Australien	7053 29	7053 30	7053 33	7053 36	7053 37
<b>ohne Netzteil</b>	7053 39	7053 40	7053 43	7053 46	7053 47

## Netzteile (110-240V/50-60 Hz)

	Best.-Nr.
für Europa (Kontinent)	7053 50
für UK/Irland	7053 51
für USA/Japan	7053 52
für Australien	7053 53

## 3er-Ständer mit Netzteil für 3 Transferpette® electronic bis 1000 µl

mit Netzteil (110-240V/50-60 Hz)	Best.-Nr.
für Europa (Kontinent)	7053 90
für UK/Irland	7053 91
für USA/Japan	7053 92
für Australien	7053 93

## Ersatz-Akku

für Transferpette® electronic

<b>Best.-Nr.</b>	7055 00
------------------	---------

## Silikonfett

für Transferpette® electronic bis 1000 µl

<b>Best.-Nr.</b>	7055 02
------------------	---------

## Silikonfett

für Transferpette® electronic 250 - 5000 µl

<b>Best.-Nr.</b>	7036 77
------------------	---------

## Qualitäts-Pipettenspitzen von BRAND, unsteril, PP

Volumen	Verp.-Einh.	Best.-Nr.
<b>lose verpackt</b>		
0,1 - 20 µl	2000	7320 02
0,5 - 20 µl	2000	7320 04
1 - 50 µl	2000	7320 06
2 - 200 µl	1000	7320 08
50 - 1000 µl	1000	7320 12
5 ml	200	7025 95
5 ml	1000	7026 00
<b>5 ml Tip-Box</b>	1 Box à 28	7026 05

## PLT unit

Pipetten-Dichtheitsprüfgerät

<b>Best.-Nr.</b>	7039 70
------------------	---------

## Filter für Transferpette® electronic

5 ml, Verpackungseinheit 25 Stück

<b>Best.-Nr.</b>	7046 52
------------------	---------



**Ersatzteile für Transferpette® electronic bis 1000 µl**

Design und Abmessungen der Ersatzteile entsprechen dem jeweiligen Nennvolumen. (Abb. Ersatzteile Transferpette® electronic 10-200 µl.)

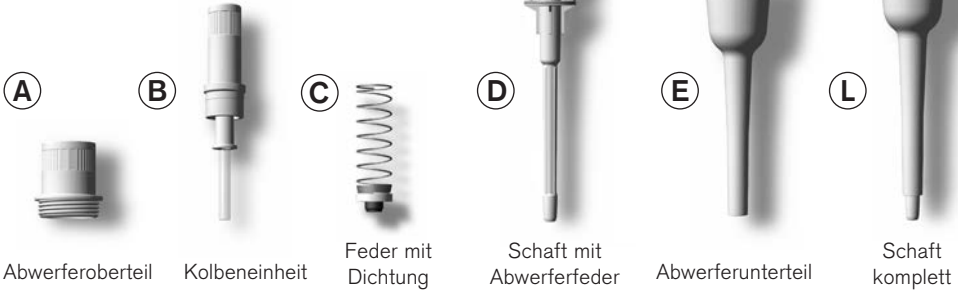

Volumen	A	B	C	D	E	L
0,5 - 10 µl	7055 10	7055 18	–	7055 38	7055 48	7055 28
2 - 20 µl	7055 10	7055 20	7055 30	7055 39	7055 50	7055 29
10 - 200 µl	7055 10	7055 22	7055 32	7055 37	7055 53	7055 46
50 - 1000 µl	7055 10	7055 24	7055 34	7055 41	7055 55	7055 47

**Ersatzteile für Transferpette® electronic 250-5000 µl**

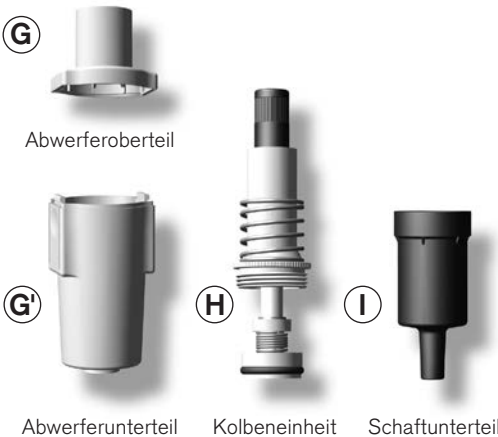

Volumen	G + G'	H	I
250 - 5000 µl	7299	7055 26	7032 47

**Zubehör für Transferpette® electronic 10-200 µl und 50-1000 µl**

Aufsteckbare Wechselclips (Abstandshalter) (F) und Pipettenschäfte (K) mit flexiblem Spitzenaufnahmekonus ermöglichen optimale Passgenauigkeit und geringstmögliche Abwurfkräfte bei den meisten handelsüblichen Pipettenspitzen.

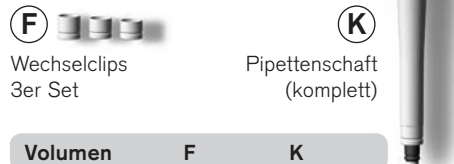

Volumen	F	K
10 - 200 µl	7055 60	7055 43
50 - 1000 µl	7055 62	7055 45

## Zur Reparatur einsenden

**Achtung!** Der Transport von gefährlichem Material ohne Genehmigung ist gesetzlich verboten.

- Gerät gründlich reinigen und dekontaminieren!
- Fügen Sie der Rücksendung von Produkten bitte grundsätzlich eine genaue Beschreibung der Art der Störung und der verwendeten Medien bei. Bei fehlender Angabe der verwendeten Medien kann das Gerät nicht repariert werden.
- Der Rücktransport geschieht auf Gefahr und Kosten des Einsenders.

## Außerhalb der USA und Kanada:

- "Erklärung zur gesundheitlichen Unbedenklichkeit" ausfüllen und gemeinsam mit dem Gerät an Hersteller oder Händler senden. Vordrucke können beim Händler oder Hersteller angefordert werden, bzw. stehen unter [www.brand.de](http://www.brand.de) zum Download bereit.

## In den USA und Kanada:

- Bitte klären Sie mit BrandTech Scientific, Inc. die Voraussetzungen für die Rücksendung **bevor** Sie das Gerät zum Service einschicken.
- Senden Sie ausschließlich gereinigte und dekontaminierte Geräte an die Adresse, die Sie zusammen mit der Rücksendenummer erhalten haben. Die Rücksendenummer außen am Paket gut sichtbar anbringen.

## Kontaktadressen

### BRAND GMBH + CO KG

Otto-Schott-Straße 25  
97877 Wertheim (Germany)  
Tel.: +49 9342 808-0  
Fax: +49 9342 808-98000  
E-Mail: [info@brand.de](mailto:info@brand.de)  
[www.brand.de](http://www.brand.de)

### USA und Kanada:

BrandTech® Scientific, Inc.  
11 Bokum Road  
Essex, CT 06426-1506 (USA)  
Tel.: +1-860-767 2562  
Fax: +1-860-767 2563  
[www.brandtech.com](http://www.brandtech.com)

### Indien:

BRAND Scientific Equipment Pvt. Ltd.  
303, 3rd Floor, 'C' Wing, Delphi  
Hiranandani Business Park, Powai  
Mumbai - 400 076 (India)  
Tel.: +91 22 42957790  
Fax: +91 22 42957791  
E-Mail: [info@brand.co.in](mailto:info@brand.co.in)  
[www.brand.co.in](http://www.brand.co.in)

### China:

BRAND (Shanghai) Trading Co., Ltd.  
Guangqi Culture Plaza  
Room 506, Building B  
No. 2899, Xietu Road  
Shanghai 200030 (P.R. China)  
Tel.: +86 21 6422 2318  
Fax: +86 21 6422 2268  
E-Mail: [info@brand.cn.com](mailto:info@brand.cn.com)  
[www.brand.cn.com](http://www.brand.cn.com)

### Kalibrierservice

Die ISO 9001 und GLP-Richtlinien fordern die regelmäßige Überprüfung Ihrer Volumenmessgeräte. Wir empfehlen, alle 3-12 Monate eine Volumenkontrolle vorzunehmen. Der Zyklus ist abhängig von den individuellen Anforderungen an das Gerät. Bei hoher Gebrauchshäufigkeit oder aggressiven Medien sollte häufiger geprüft werden. Die ausführliche Prüfanweisung steht unter [www.brand.de](http://www.brand.de) bzw. [www.brandtech.com](http://www.brandtech.com) zum Download bereit.

BRAND bietet Ihnen darüber hinaus die Möglichkeit, Ihre Geräte durch unseren Werks-Kalibrierservice oder durch das BRAND-DAkKS-Labor kalibrieren zu lassen.

Schicken Sie uns einfach die zu kalibrierenden Geräte mit der Angabe, welche Art der Kalibrierung Sie wünschen. Sie erhalten die Geräte nach wenigen Tagen zusammen mit einem Prüfbericht (Werkskalibrierung) bzw. mit einem DAkKS-Kalibrierschein zurück. Nähere Informationen erhalten Sie von Ihrem Fachhändler oder direkt von BRAND.

Die Bestellunterlage steht unter [www.brand.de](http://www.brand.de) zum Download bereit (s. Technische Unterlagen).

## Mängelhaftung

Wir haften nicht für Folgen unsachgemäßer Behandlung, Verwendung, Wartung, Bedienung oder nicht autorisierter Reparatur des Gerätes oder für Folgen normaler Abnutzung, insbesondere von Verschleißteilen wie z.B. Kolben, Dichtungen, Ventilen sowie bei Glasbruch. Gleiches gilt für die Nichtbeachtung der Gebrauchsanleitung. Insbesondere übernehmen wir keine Haftung für entstandene Schäden, wenn das Gerät weiter zerlegt wurde als in der Gebrauchsanleitung beschrieben oder wenn fremde Zubehör- bzw. Ersatzteile eingebaut wurden.

USA und Kanada:

Informationen zur Mängelhaftung finden Sie unter [www.brandtech.com](http://www.brandtech.com).

## Entsorgung

---

Das nebenstehende Symbol bedeutet, dass Batterien/Akkus und elektronische Geräte am Ende ihrer Lebensdauer vom Hausmüll (unsortierter Siedlungsabfall) getrennt entsorgt werden müssen.

- Elektronische Geräte müssen gemäß der Richtlinie 2002/96/EG des europäischen Parlaments und des Rates vom 27. Januar 2003 über Elektro- und Elektronik-Altgeräte fachgerecht entsprechend den nationalen Entsorgungsvorschriften entsorgt werden.



- Batterien und Akkus enthalten Stoffe, die sich schädlich auf die Umwelt und die menschliche Gesundheit auswirken können. Sie müssen daher gemäß der Richtlinie 2006/66/EG des europäischen Parlaments und des Rates vom 06. September 2006 über Batterien und Akkumulatoren fachgerecht entsprechend den nationalen Entsorgungsvorschriften entsorgt werden. Nur vollständig entladene Batterien und Akkus entsorgen.

### **Warnung!**

Batterien und Akkus zum Entladen nicht kurzschließen!

	Page
Safety Instructions	38
Functions and Limitations of Use	39
Operating Exclusions	39
<b>Operating Elements</b>	<b>40</b>
The First Steps	41
Setting the Volume	42
Setting the Aspiration and Discharging Speed	43
Correct Pipetting	44
The Pipetting Programs	45
<b>PIP mode</b>	<b>46</b>
<b>PIPmix mode</b>	<b>48</b>
<b>revPIP mode</b>	<b>50</b>
<b>Electrophoresis (GEL) mode</b>	<b>52</b>
<b>DISP mode</b>	<b>54</b>
Checking the Volume	56
Accuracy Table	57
<b>Easy Calibration (adjustment)</b>	<b>58</b>
Autoclaving	60
Reference Run (rEF)	60
Servicing and Cleaning	61
Charging and Replacing the Battery	63
Battery Regeneration Function	63
Troubleshooting	65
Ordering Information · Accessories · Spare Parts	66
Repairs · Contact Addresses	68
Calibration Service	69
Warranty Information · Disposal	70

## Safety Instructions

This instrument may sometimes be used with hazardous materials, operations, and equipment. It is beyond the scope of this manual to address all of the potential safety problems associated with its use in such applications. It is the responsibility of the user of this pipette to consult and establish appropriate safety and health practices and determine the applicability of regulatory limitations prior to use.



### Please read the following carefully!

1. Every user must read and understand this operating manual prior to using the instrument and observe these instructions during use.
2. Follow general instructions for hazard prevention and safety instructions; e.g., wear protective clothing, eye protection and gloves.  
When working with infectious or other hazardous samples, all appropriate regulations and precautions must be followed.
3. Observe all specifications provided by reagent manufacturers.
4. Never use the instrument in an atmosphere with a danger of explosion. Highly flammable liquids must not be pipetted.
5. Only use the instrument for pipetting liquids that conform to the specifications defined in the operating exclusions and limitations (see page 39). If in doubt, contact the manufacturer or supplier.
6. Always use the instrument in such a way that neither the user nor any other person is endangered. Avoid splashes. Only use suitable vessels.
7. Avoid touching the tip orifices when working with hazardous samples.
8. Never use force on the instrument!
9. Use only original spare parts. Do not attempt to make any technical alterations. Do not dismantle the instrument any further than is described in the operating manual!
10. Before use check the instrument for visible damages. If there is a sign of a potential malfunction (e.g., piston difficult to move, mechanically damaged connections), immediately stop titrating. Consult the 'Troubleshooting' section of this manual (see page 65), and contact the manufacturer if needed.
11. The original battery must not be replaced with non rechargeable batteries or rechargeable batteries of other manufacturers.
12. To charge the NiMH battery pack, use only the original AC adapter.
13. The AC adapter has to be protected against moisture and must be used only for this instrument.
14. Dispose of batteries only when discharged and according to applicable regulations.

### Warning!

Improper use of the instrument or the batteries (short circuit, mechanical damage, overheating, incorrect AC adapter, etc.) can lead to battery explosion.

The Transferpette® electronic is a microprocessor-controlled, battery-operated piston-stroke pipette which uses the air-displacement principle for the pipetting of aqueous solutions with an average density and viscosity.

When the instrument is used properly, the sample only comes into contact with the tip and not with the Transferpette® electronic.

### Limitations of use

The Transferpette® electronic is intended for the pipetting of liquids within the following limitations:

- Temperature of both the instrument and solution should be between 15 °C to 40 °C (59 °F to 104 °F). Consult the manufacturer for use in temperatures outside of this range.
- Vapor pressure up to 500 mbar
- Viscosity: 260 mPa s (260 cps)

### Operating exclusions

The user has to ensure the compatibility of the instrument with the intended application.

Never use the instrument for pipetting liquids, that react adversely with polypropylene (PP: shaft and tips), polycarbonate/polybutyleneterephthalate (PC/PBT: casing) or EPDM (flexible replacement pipette shafts). Avoid reactive vapors due to the danger of corrosion.

The handle is not autoclavable.

### Operating Limitations

Viscous and highly adhesive liquids may impair volumetric accuracy. Volumetric accuracy may also be impaired when pipetting liquids that differ from ambient temperature by more than  $\pm 5$  °C / 41 °F.

### Battery and AC adapter specifications

#### Battery

Nickel-metal hydride battery with 3 cylindrical individual cells with size AAA, 3.6 V, 700 mAh

#### AC adapter

Output voltage 6.5 V DC, 200 mA

# Operating Elements

The Transferpette® electronic is a microprocessor-controlled, battery-operated, piston-stroke pipette, which has been optimized for ergonomic operation and ease of use.

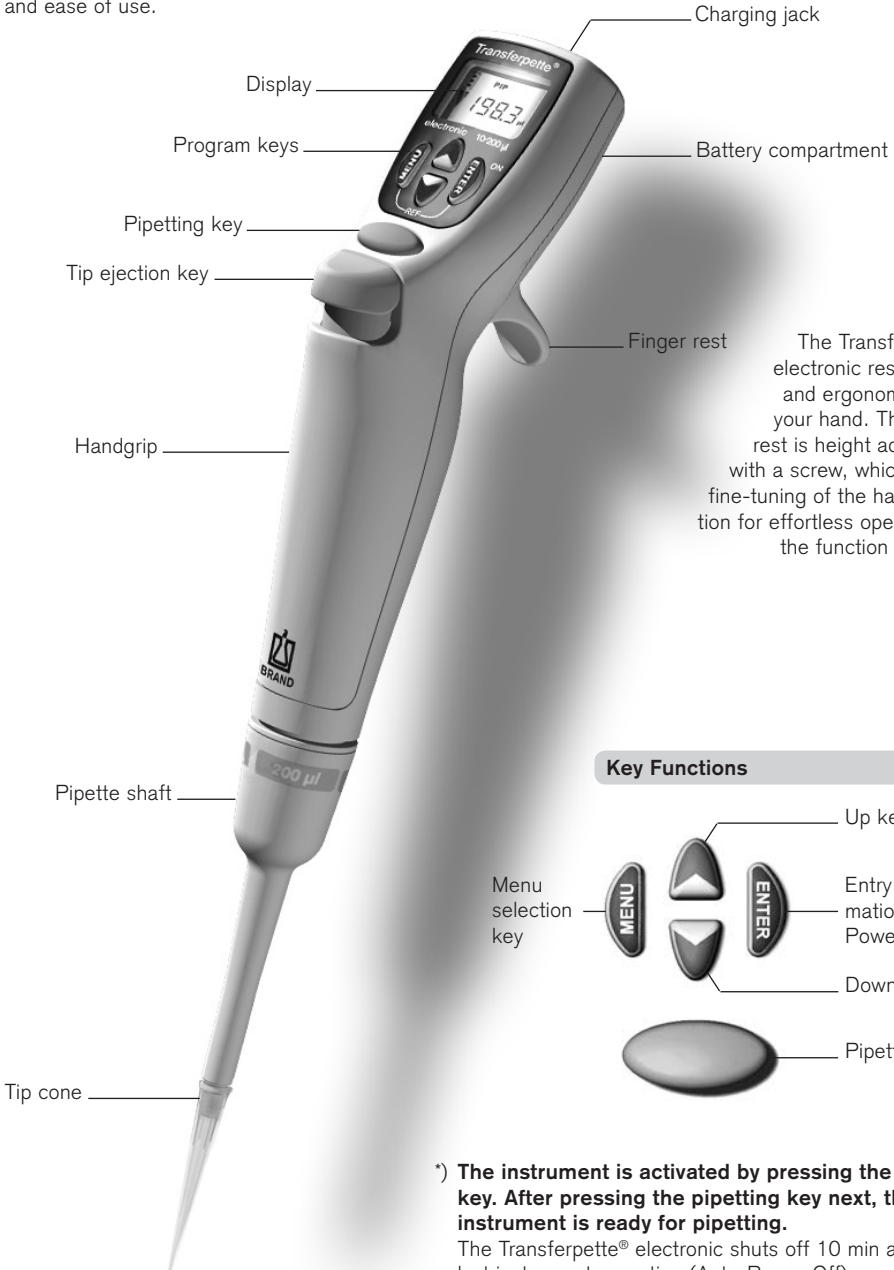

The Transferpette® electronic rests easily and ergonomically in your hand. The finger rest is height adjustable with a screw, which allows fine-tuning of the hand position for effortless operation of the function buttons.

## Key Functions

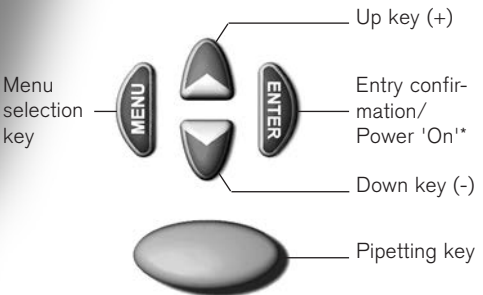

**\*) The instrument is activated by pressing the ENTER key. After pressing the pipetting key next, the instrument is ready for pipetting.**  
 The Transferpette® electronic shuts off 10 min after the last instrument operation (Auto-Power-Off).



## Is everything in the package?

Confirm that your package includes: Transferpette® electronic pipette, battery, AC adapter with battery charging cable, silicone oil, operating manual and one bag with sample pipette tips.

### Initializing the Transferpette® electronic

#### 1. Insert the battery

- Open the cover of the battery compartment.
- Insure that the plug for the battery is firmly connected to the pipette. Insert the battery.
- Replace the battery compartment.



#### 2. Activate the instrument

The Transferpette® electronic automatically requests a reference run directly after the battery is inserted. After the pipetting key is pressed, the reference run is carried out and the instrument is now ready for pipetting.





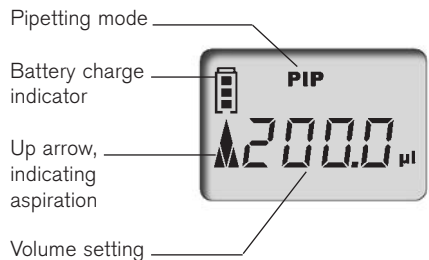



The display shows the standard factory setting (pipetting mode/PIP); and the nominal volume (for example, 200.0 µl). Default aspiration and discharging speeds are at maximum. The adjustment of volume and speed is described on the following pages.

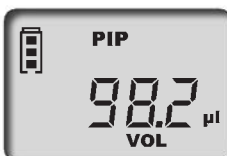

## Setting the Volume

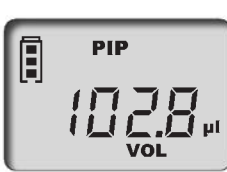
The volume for the Transferpette® electronic is set at the factory to the nominal volume of the instrument and can be changed quickly and easily.

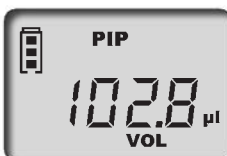
What to do	How to do it	Keys to press	Display readout
<b>1. Activate volume setting</b>	Press one of the arrow keys to activate volume selection. <b>,VOL'</b> blinks.		
<b>2. Change the volume</b>			
<b>Reduce volume</b>	Press the down arrow key (-) to reduce the volume. Holding the arrow key down accelerates the rate of change. <b>,VOL'</b> continues to blink.		
<b>Increase volume</b>	Press the up arrow key (+) to increase the volume. Holding the arrow key down accelerates the rate of change. <b>,VOL'</b> continues to blink.		
<b>3. Confirm volume setting</b>	Press the ENTER key. The display now shows the new volume setting, in this case, 102.8 µl in the PIP mode.		

### Important:





By pressing the MENU key any procedure can be cancelled! The display then moves to the next setting or back to the initial display (depending on actual selection.)

# Setting the Aspiration and Discharging Speed



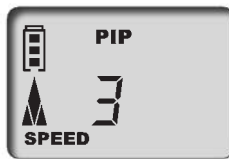

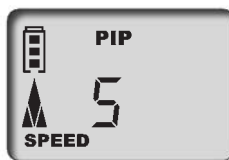
The aspiration and discharging speeds can be individually adjusted. When the menu is called up, the last speed setting is shown. Five speed levels are available.

What to do	How to do it	Keys to press	Display readout
------------	--------------	---------------	-----------------

## Setting the aspiration speed

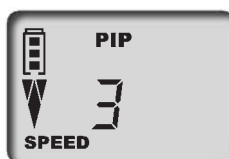
<b>1. Bring up the menu</b>	Press the MENU key once to bring up the aspiration speed menu. <b>'Speed'</b> blinks.	1x 	
<b>2. Change the aspiration speed</b>	Press one of the arrow keys (+/-) to select the desired speed (in this case, level 5). <b>'Speed'</b> continues to blink.		
<b>3. Confirm speed level</b>	Press the ENTER key. The display returns to the start position for the current pipetting mode (in this case, the standard PIP mode).		

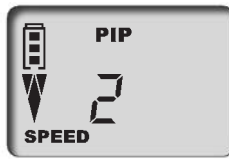
## Setting the discharging speed

<b>1. Bring up the menu</b>	Press the MENU key twice to bring up the discharging speed menu. <b>'Speed'</b> blinks.	2x 	
<b>2. Change the discharging speed</b>	Press one of the arrow keys (+/-) to select the desired speed (in this case, level 2). <b>'Speed'</b> continues to blink.		
<b>3. Confirm speed level</b>	Press the ENTER key. The display returns to the start position for the current pipetting mode (in this case, the standard PIP mode).		

The volume is set at the factory to the nominal volume for the Transferpette® electronic and can be changed quickly and easily. See page 42.

## Quick start in the standard pipetting mode

### 1. Attach the tip

Use the correct tip according to the volume range or the color code. Ensure that the tip is securely seated. When using the flexible pipette shaft, attach an alternative ejector adjustment clip if necessary. Pipette tips are disposable items!

### 2. Aspirate liquid

Hold the pipette vertically and immerse the tip 2 to 3 mm into the liquid.

Press the pipetting key to aspirate the liquid into the tip. The arrow in the display points upwards to indicate the aspiration of liquid.



**Note:** To avoid the intake of air, leave the tip immersed into the liquid for approx. 1 sec.

### 3. Discharge liquid

After the liquid has been aspirated, the arrow in the display points downwards to indicate discharging.

Hold the pipette at an angle between 30° and 45°, place the tip against the vessel wall.

Press the pipetting key again and the liquid is completely discharged including automatic blowout. Wipe pipette tip against the vessel wall.

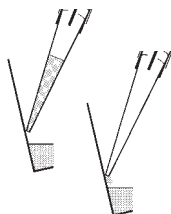

### 4. Eject tip

Hold the pipette shaft over a suitable disposal container and press the tip ejector key.



Tip ejection key























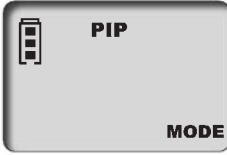







**Note:**

ISO 8655 prescribes rinsing the pipette tip once with the sample liquid prior to the actual pipetting process.



	Page
<b>1. Normal Pipetting</b>	
<b>PIP</b> Mode _____	<b>46</b>
<p>Standard program. A previously set volume is aspirated into the pipette tip and then discharged.</p>	
<b>2. Mixing of Samples</b>	
<b>PIPMix</b> Mode _____	<b>48</b>
<p>Program for mixing liquids. The sample is repeatedly aspirated and discharged.</p>	
<b>3. Reverse Pipetting</b>	
<b>revPIP</b> Mode _____	<b>50</b>
<p>Program especially for pipetting liquids with a high viscosity or vapor pressure, or that tend to foam.</p>	
<b>4. Pipetting for Electrophoresis</b>	
<b>GEL</b> Mode _____	<b>52</b>
<p>Program for loading electrophoresis gels. A predefined sample volume is aspirated at high, adjustable speed and then slowly discharged.</p>	
<b>5. Dispensing</b>	
<b>DISP</b> Mode _____	<b>54</b>
<p>Program for dispensing liquids. An aspirated volume is dispensed repeatedly in defined steps.</p>	

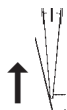

GEL mode is not available for Transferpette® electronic 1000 µl and 5000 µl.

The standard program – a previously set volume is aspirated and then discharged.  
Volume and speed adjustments are described on pages 42 and 43.

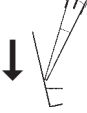
What to do	How to do it	Keys to press	Display readout
1. Bring up the menu	Press the MENU key three times to bring up the mode selection menu. <b>,Mode'</b> blinks.	3x     	
2. Select PIP mode	Use one of the arrow keys to scroll through the modes until <b>,PIP'</b> appears. <b>,Mode'</b> continues to blink.	    	
3. Confirm PIP mode	Press the ENTER key. The display now shows <b>,blo'</b> for blow-out.	    1x 	
4. Prepare for pipetting	Press the pipetting key once to move the piston into the start position. The arrow in the display points upwards (aspiration).	    1x 	
5. Aspirate liquid	Press the pipetting key once to aspirate the liquid.	    1x 	







What to do	How to do it	Keys to press	Display readout
<p><b>6. Discharge liquid</b></p> 	<p>Press the pipetting key once to discharge the liquid. The arrow in the display points downwards (discharge).</p>		

<p><b>7. Start blow-out?</b></p>	<p><b>No action required!</b> When pipetting in the PIP mode the <b>blow-out function is performed automatically.</b></p>		
----------------------------------	---	---	--

## Start blow-out manually

The blow-out function can, if necessary, be initiated manually at any time.

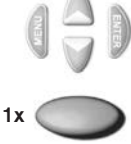













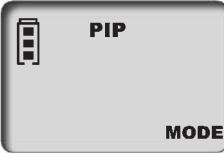













<p><b>1. Bring up the blow-out function</b></p>	<p>Press the ENTER key. The display shows <b>‚blo‘</b> for blow-out.</p>		
---	--	--	---

<p><b>2. Start blow-out</b></p>	<p>Press the pipetting key once to initiate the blow-out process. The display moves back to the start position of the selected pipetting mode.</p>		
---------------------------------	--	---	--

**Note:**



To accomplish the blow-out, the piston moves to its lowest position. The user must be certain that any residual liquid is discharged safely. **If the pipetting key is pressed and held, the piston will be maintained at its lowest position to avert an accidental aspiration of liquid. When the key is released, the piston returns to the start position**

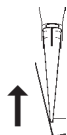

Program for mixing of liquids. The sample is repeatedly aspirated and discharged.  
Volume and speed adjustments are described on pages 42 and 43.

What to do	How to do it	Keys to press	Display readout
1. Bring up the menu	Press the MENU key three times to bring up the mode selection menu. <b>,Mode'</b> blinks.	3x     	
2. Select PIPmix mode	Scroll through the modes using the arrow keys until <b>,PIPmix'</b> appears. <b>,Mode'</b> continues to blink.	    	
3. Confirm PIPmix mode	Press the ENTER key. The Display now shows <b>,blo'</b> for blow-out.	    1x 	
4. Prepare for pipetting	Press the pipetting key once to move the piston into the start position. The arrow in the display points upwards (aspiration).	    1x 	
5. Aspirate liquid	Press the pipetting key once to aspirate the liquid.	    1x 	

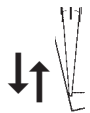















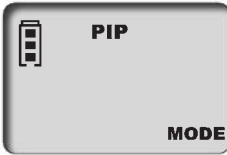





























What to do	How to do it	Keys to press	Display readout
<p><b>6. Discharge liquid in the PIPmix mode</b></p> 	<p>Press and hold the pipetting key and the liquid is alternately aspirated and discharged. The display shows the up arrow for aspiration and the down arrow for discharging and the number of cycles.</p>	 <p>press and hold</p>	

<p><b>7. End pipetting</b></p>	<p>Press the pipetting key once and the liquid is discharged and the blow-out function initiated.</p> <p>After the discharge of the residual liquid (blow-out), the display moves back to the start position.</p>	 <p>1x</p>	
--------------------------------	---	---	--





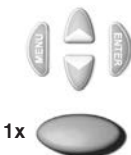































**Note:** The display shows a maximum of 19 cycles.



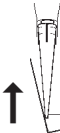



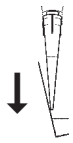

Program for pipetting of liquids with high viscosity, vapor pressure or that tend to foam.  
Volume and speed adjustments are described on pages 42 and 43.

What to do	How to do it	Keys to press	Display readout
1. Bring up the menu	Press the MENU key three times to bring up the mode selection menu. <b>,Mode'</b> blinks.	3x     	
2. Select revPIP mode	Scroll through the modes using the arrow keys until <b>,revPIP'</b> appears. <b>,Mode'</b> continues to blink.	    	
3. Confirm revPIP mode	Press the ENTER key. The Display now shows <b>,blo'</b> for blow-out.	    1x 	
4. Prepare for pipetting	Press the pipetting key once to move the piston into the start position. The arrow in the display points upwards (aspiration).	    	
5. Aspirate liquid	Press the pipetting key once. The volume aspirated will be a little bit more than set.	    	
6. Discharge liquid in the revPIP mode	To discharge the measured amount of liquid, press the pipetting key once. The arrow in the display points downwards (discharge). Some liquid will remain in the tip.	    	

What to do	How to do it	Keys to press	Display readout
<p><b>7. Repeat aspiration of liquid in revPIP mode</b></p> 	<p>Press the pipetting key again and the set volume is aspirated into the tip. Press the pipetting key again and the volume is discharged again, and so on...</p>		
<p><b>8. Initiate blow-out</b></p>	<p>Press the ENTER key after the last pipetting operation. The display shows <b>,blo'</b> for blow-out.</p>		
	<p>Press the pipetting key once to initiate the blow-out process. The residual liquid is discharged.</p>		
<p><b>9. End pipetting</b></p>	<p>After the residual liquid is discharged (blow-out), the display moves back to the start position.</p>		

Program for loading electrophoresis gels. A predefined sample volume is aspirated into the pipette tip with high adjustable speed and then slowly discharged. Volume and speed adjustment is described on pages 42 and 43.

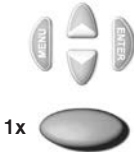













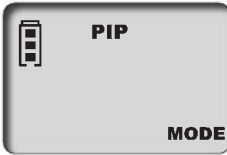





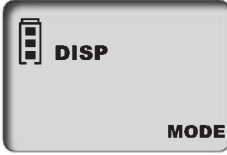













What to do	How to do it	Keys to press	Display readout
1. Bring up the menu	Press the MENU key three times to bring up the mode selection menu. <b>,Mode'</b> blinks.	3x     	
2. Select GEL mode	Scroll through the modes using the arrow keys until <b>,GEL'</b> appears. <b>,Mode'</b> continues to blink.	    	
3. Confirm GEL mode	Press the ENTER key. The Display now shows <b>,blo'</b> for blow-out.	    1x 	
4. Prepare for pipetting	Press the pipetting key once to move the piston into the start position. The arrow in the display points upwards (aspiration).	    	
5. Aspirate liquid	Press the pipetting key once. The set volume is aspirated into the tip.	    	
	<b>Aspirate a larger volume</b> In order to aspirate a larger volume than was set (up to a max. of 110% of the nominal volume), press and hold the pipetting key until the desired volume has been aspirated. The display shows a rhombus.	     press and hold	











What to do	How to do it	Keys to press	Display readout
<p><b>6. Discharge liquid in the GEL mode</b></p> 	<p>Press the pipetting key once to discharge the liquid. The rhombus is shown in the display. The liquid is discharged very slowly.</p>		
	<p><b>Interrupt discharging</b> To interrupt discharging, press the pipetting key again. The display shows the volume discharged prior to interruption.</p>		
<p><b>7. Initiate blow-out</b></p>	<p>Press the ENTER key after the last pipetting operation. The display shows <b>,blo'</b> for blow-out.</p>		
	<p>Press the pipetting key once to initiate the blow-out process. The residual liquid is discharged.</p>		
<p><b>8. End pipetting</b></p>	<p>After the residual liquid is discharged (blow-out), the display moves back to the start position.</p>		

**Note:**

The GEL mode operates using a very slow discharge speed to prevent swirling of the samples. To assure optimal discharging into a gel, this discharge speed is fixed for the GEL mode. This speed is significantly slower than level 1 and cannot be selected individually.

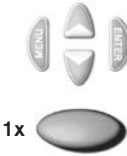
Program for discharging an aspirated liquid in pre-defined steps.  
 The volume aspirated will be a little bit more than actually needed.  
 Speed adjustment is described on page 43.

What to do	How to do it	Keys to press	Display readout
1. Bring up the menu	Press the MENU key three times to bring up the mode selection menu. <b>,Mode'</b> blinks.	3x     	
2. Select DISP mode	Scroll through the modes using the arrow keys until <b>,DISP'</b> appears. <b>,Mode'</b> continues to blink.	    	
3. Confirm DISP mode	Press the ENTER key. The Display now shows <b>,blo'</b> for blow-out.	    1x 	
4. Prepare for dispensing	Press the pipetting key once to move the piston into the start position. The arrow in the display points upwards (aspiration).	     1x	
5. Set dispensing step volume	Press the arrow keys (+/-) to set the volume. Holding the arrow key down accelerates the rate of change. <b>,VOL'</b> blinks.	  +  -  	
6. Confirm dispensing step volume	Press the ENTER key. The display now shows the new volume setting for the dispensing steps and the max. number of steps. <b>,Steps'</b> blinks.	    1x 	

What to do	How to do it	Keys to press	Display readout
7. Set the number of steps	Press the arrow keys (+/-) to set the number of steps. 'Steps' continues to blink.		
8. Confirm the number of steps	Press the ENTER key. The display now shows the number of steps that has been set.		
9. Aspirate liquid	Press the pipetting key once to aspirate the liquid.		
10. Dispense liquid	Each time the pipetting key is pressed one dispensing step is performed. The arrow in the display points downwards (discharge). The display shows the number of dispensing steps left.		
11. Initiate blow-out	Press the ENTER key after the last dispensing step. The display shows 'blo' for blow-out. Press the pipetting key next once to initiate the blow-out process (see also p. 53).		
12. End dispensing	After the residual liquid is discharged (blow-out), the display moves back to the start position.		

# Checking the Volume

Depending on use, we recommend inspection of the instrument every 3 to 12 months. The cycle can, however, be adjusted to individual requirements.

The gravimetric testing of the pipette volume is performed according to the following steps and is in accordance with DIN EN ISO 8655, Part 6.

## 1. Set nominal volume

Set volume to the maximum volume indicated on the instrument. See page 42 for procedure.

## 2. Condition the pipette

Condition the pipette before testing by using a pipette tip to aspirate and discharge the test liquid (distilled H<sub>2</sub>O) five times. After this, discard the pipette tip.

## 3. Carry out the test

- Attach new pipette tip and pre-rinse one time with test liquid.
- Aspirate liquid and pipette it into the weighing vessel.
- Weigh the pipetted quantity with an analytical balance. Please follow the operating manual instructions from the balance manufacturer.
- Calculate the volume, taking the temperature into account.
- At least 10 pipettings and weighings in three volume ranges (100 %, 50 %, 10 %) are recommended for statistical analysis.

### Calculation (for nominal volume)

$x_i$  = Weighing results  
 $n$  = Number of weighings

$Z$  = Correction factor  
(for example 1.0029 µl/mg at 20 °C, 1013 hPa)

Mean value  $\bar{x} = \frac{\sum x_i}{n}$

Mean volume  $\bar{V} = \bar{x} \cdot Z$

#### Accuracy\*

$$A\% = \frac{\bar{V} - V_0}{V_0} \cdot 100$$

$V_0$  = Nominal volume

#### Standard Deviation

$$s = Z \cdot \sqrt{\frac{\sum (x_i - \bar{x})^2}{n - 1}}$$

#### Coefficient of Variation\*

$$CV\% = \frac{100 s}{\bar{V}}$$

\*) = Calculation of accuracy (A %) and variation coefficient (CV %):

A % and CV % are calculated according to the formulas for statistical control.



## Accuracy Table

Final test values related to the nominal capacity (maximum volume) indicated on the instrument and the indicated volume steps, obtained when instrument and distilled water are equilibrated at ambient temperature (20 °C/68 °F) and with smooth operation. According to DIN EN ISO 8655.



### Accuracy tolerances for the Transferpette® electronic

Volume range µl	Volume step µl	A* ≤ ± %	CV* ≤ %	Increment µl	Recommended type of tip, µl
0.5 - 10	10	1.0	0.4	0.01	0.5 - 20
	5	1.5	0.8		
	1	5.0	2.0		
2 - 20	20	1.0	0.4	0.02	0.5 - 20
	10	1.5	0.8		
	2	5.0	2.5		
10 - 200	200	0.8	0.2	0.2	2 - 200
	100	1.2	0.3		
	20	4.0	0.6		
50 - 1000	1000	0.6	0.2	1.0	50 - 1000
	500	1.0	0.3		
	100	3.0	0.6		
250 - 5000	5000	0.6	0.2	5.0	500 - 5000
	2500	1.0	0.3		
	500	3.0	0.6		

\* A = Accuracy, CV = Coefficient of Variation

#### Note:

The device is marked in accordance with the German Measurement and Calibration Act as well as the Measurement and Calibration Regulation:

**DE-M** 19

Character string: DE-M (DE for Germany), framed by a rectangle, as well as the last two digits of the year in which the marking was affixed (here: 2019).

#### Note:

Testing instructions (SOPs) and a demo version of the EASYCAL™ 4.0 calibration software are available for download at [www.brand.de](http://www.brand.de).

### The calibration mode ,CAL'

#### Adjustment

The instrument should be set to either the nominal volume (for example 200 µl for a 200 µl pipette) or a specific test volume, in the standard pipetting mode (PIP). See page 42 and 46 for procedures. E.g., volume according to testing of volume 201.3 µl.



What to do	How to do it	Keys to press	Display readout
1. Bring up the CAL mode	Press and hold the MENU key (> 3 sec) until CAL appears. The display reads ,off'. ,CAL' blinks.	1x >3s 	
2. Activate the CAL mode	Press one of the arrow buttons to activate the CAL mode. The display changes from ,off' to ,on'. ,CAL' continues to blink.		
3. Confirm CAL mode	Press the ENTER key. The display now shows the set pipetting volume. ,CAL' blinks.		
4. Set the volume	Use the arrow keys (+/-) to set the volume, which was previously determined and tested. ,CAL' blinks.		
5. Confirm volume	Press the ENTER key. The display shows the tested and corrected volume. The CAL symbol is continuously displayed to confirm that an adjustment has been made.		

## Revert to factory default settings

The continually displayed CAL symbol refers to a previously made adjustment.



What to do	How to do it	Keys to press	Display readout
1. Bring up the CAL mode	Press and hold the MENU key (> 3 sec) until CAL appears. The display reads ,on'. ,CAL' blinks.	1x MENU >3s	PIP on CAL
2. Deactivate CAL mode	Press one of the arrow keys to deactivate the CAL mode. The display changes from ,on' to ,off'. ,CAL' continues to blink.	MENU ENTER	PIP off CAL
3. Revert to factory setting	Press the ENTER key. The CAL symbol disappears. The instrument has now been reverted to factory default setting.	MENU ENTER 1x	PIP 2000 µl CAL

**Important:** When the Transferpette® electronic is adjusted, a volume offset is performed, which means that the volume is changed across the entire volume range of the pipette by the same amount. It is recommend that the adjustment be performed at 50% of the nominal volume.

**Note:** The instrument is permanently adjusted for watery solutions, but it can also be set for solutions with varying density, viscosity and temperature. The Transferpette® electronic can be adjusted in every mode, with the exception of the GEL mode.

# Autoclaving

The pipette shaft of the Transferpette® electronic (highlighted in picture) can be autoclaved at 121 °C (250 °F) at a pressure of 2 bar (30 psi) with a holding time of at least 15 minutes according to DIN EN 285.

**Attention:** The handgrip can not be autoclaved!

1. Eject the pipette tip.
2. Unscrew the pipette shaft from the grip.
3. Autoclave the complete pipette shaft without any further disassembling.
4. Allow the pipette shaft to completely cool and dry.
5. Screw the pipette shaft into the grip again.
6. Perform a reference run (rEF).

**Note:** The effectiveness of the autoclaving must be verified by the user. Maximum reliability is obtained with vacuum sterilization. We recommend the use of sterilization bags.

If the pipette shaft is autoclaved frequently, then the piston and seal should be greased with the supplied silicone grease in order to preserve smooth movement.



## Reference run (rEF)

A manual reference run must be completed each time the pipette shaft is reattached to the handle. The reference run is needed to assure secure connection of the piston.

What to do	How to do it	Keys to press	Display readout
1. Bring up rEF mode	Simultaneously press the MENU and the ENTER key to activate the rEF mode.		
2. Perform the reference run	Press the pipetting key once to start the reference run. A noise can be heard, clearly indicating the function is being performed.		

**Note:** After the reference run, the display automatically returns to the previous program.

In order to assure proper functioning, the Transferpette® electronic should be serviced and cleaned at regular intervals.

### Servicing

Inspect the pipette tip cone for damage.

Inspect the piston and seal for contamination and damage.

Test the sealing of the instrument. We recommend using the BRAND leak testing instrument PLT unit. Alternatively: to do this aspirate a sample, and then hold the instrument in a vertical position for about 10 sec. If a drop forms at the tip orifice, see the troubleshooting guide on page 65.

### Disassembly and cleaning

1. Unscrew the pipette shaft (S) from the hand grip.
2. Separate the magnetic connection between both components by gently but firmly pulling in opposite directions.
3. Unscrew the upper part of the ejector (A) from the pipette shaft.
4. Pull the shaft (D and B) out of the lower part (E) of the ejector.
5. Unscrew the retention sleeve (B).
 

**Note:** The piston and piston guide remain connected with the retention sleeve (B)!
6. Remove the spring and seal (C).
7. Clean the parts shown with a mild soap solution or isopropanol and then rinse with distilled water.
8. Allow the parts to dry (max. 120 °C/248 °F).
9. Grease piston with a very thin layer of oil.
10. Assemble the cooled parts in reverse order from above. The retention sleeve and the upper part of the ejector (A, B) should only be hand-tight.
11. Perform reference run (rEF).

**Note:** All individual components shown, can be ordered as spare parts. For ordering information see page 67.

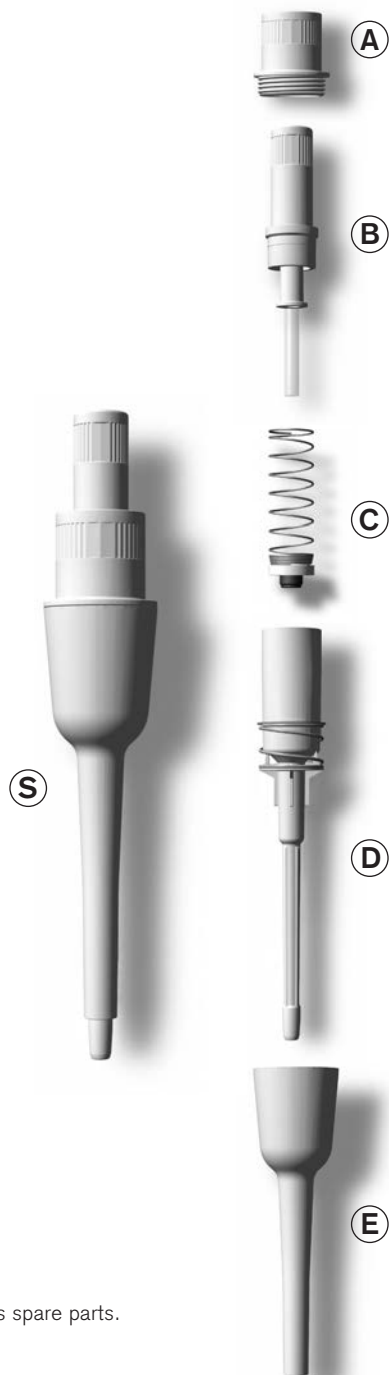

In order to assure proper functioning, the Transferpette® electronic should be serviced and cleaned at regular intervals.

## Servicing

Inspect the pipette tip cone for damage.

Inspect the piston and seal for contamination and damage.

Test the sealing of the instrument. We recommend using the BRAND leak testing instrument PLT unit. Alternatively: to do this aspirate a sample, and then hold the instrument in a vertical position for about 10 sec. If a drop forms at the tip orifice, see the troubleshooting guide on page 65.

## Disassembly and cleaning

1. Press both snap-in locks (J) simultaneously and remove lower part of ejector (G').
2. Unscrew and remove the pipette shaft (H+I) from the hand grip.
3. Separate the magnetic connection between both components by gently but firmly pulling in opposite directions and remove upper part of ejector (G).
4. Unscrew piston unit (H) from lower part of the pipette shaft (I).
5. Remove the O-ring from the piston unit and clean it.

**Note:** Do not disassemble piston unit (H) any further!

6. Clean piston unit (H) and lower part of pipette shaft (I) with a mild soap solution or isopropanol and then rinse with distilled water.
7. Allow the parts to dry (max. 120 °C/248 °F) and to cool down.
8. Carefully grease O-ring inside and outside and put it back in place.
9. Assemble the cooled parts in reverse order from above.
10. Perform reference run (rEF).

**Note:** Individual components shown can be ordered as spare parts. For ordering information see page 67.

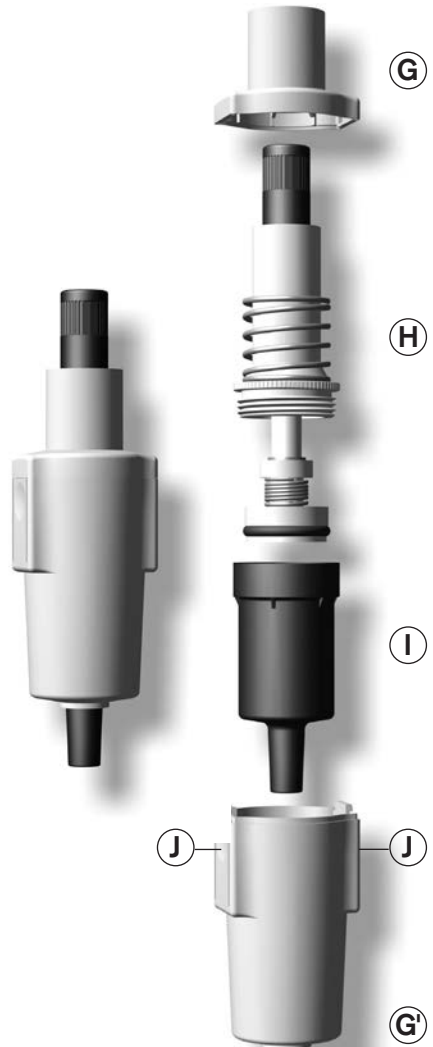

## Charging and Replacing the Battery

A fully charged battery allows approx. eight hours (equals more than 4000 pipetting cycles) of continuous pipetting of liquids with a viscosity and density similar to water.

### Important!

Before charging the battery ensure that the AC adapter is compatible with the line voltage in the laboratory. Do not charge the device in an explosive environment. The battery can only be charged inside the Transferpette® electronic.

### Charge the battery

- Insert the charging cable plug for the AC adapter into the jack at the top of the Transferpette® electronic; charging starts automatically
- During the charging, the bars for the battery capacity run continually from the bottom to the top. The battery is fully charged, when the bars in the display have stopped moving.



### Pipetting during charging?

During charging, you can continue to work with the Transferpette® electronic.

If the battery is fully discharged, it will take a few minutes until a certain minimum charge capacity is available, which is needed to operate the instrument safely.

**Note:** The last settings are stored in the memory of the instrument. If the battery is fully discharged or the battery is changed, these settings are saved.

### Replace the battery

- Open the battery compartment cover. Remove the battery and pull the plug gently out of the socket.
- Insert the plug of the new battery into the socket and insert the battery.
- Put the battery compartment cover in place again and close it.



Remove the battery from the instrument, when it is not to be used for longer periods.

## Charging and Replacing the Battery

### Battery display after inserting a battery

- a) After the battery is inserted, the display shows the **full capacity indicator with a blinking frame**, the instrument does not recognize the charging status right now. After 3.5 hours of charging time – safe full charging of the battery – the frame stops blinking.



**Note:** After inserting a battery always charge 3.5 hours!  
The full charge capacity is available after several charge/discharge cycles.

## Battery regeneration function

### (Refresh function)

In order to extend the service life and to optimize performance of the battery, the Transferpette® electronic has a regeneration function (refresh function). This program provides a controlled full discharge and recharging of the battery. To optimize the battery performance, this refresh function should be used periodically.

### Perform the refresh function

- a) Insert the plug for the AC adapter into the jack on the top of the Transferpette® electronic.



- b) Press and hold the lower arrow key (>3 sec). During the discharging process, the capacity bars for the battery indicator run continually from the top to the bottom.



- c) After the controlled discharge (up to 3 hours), the charging process (3.5 hours) is started automatically. During charging, the capacity bars run continually from the bottom to the top.







### Interrupting the refresh function

Press any button to end the program. The instrument switches automatically to the standard pipette mode (PIP) and to the nominal volume and the normal charging process is started automatically, see page 63. Removing the plug for the AC adapter also ends the program. Do not interrupt refresh function at the end of the discharge cycle.



If an error occurs, the instrument display shows "Err" and the error number is also shown. The instrument will now only react to the ENTER key. Pressing the ENTER key will attempt to restart the instrument. Therefore, a reference run is automatically requested.

Problem	Error message	Possible cause	Corrective action
Instrument does not react		Battery discharged or faulty	Charge battery for at least 5 min without operating, then only operate with charging cable attached until battery is recharged. Replace battery if needed.
		Faulty electronic component	Send in the instrument for repair.
Instrument does not react		Faulty electronic component	Send in the instrument for repair.
Instrument does not react		Unpredicted program error	Confirm error by pressing the ENTER key. The instrument is reinitialized.
Instrument does not react		No battery inserted	Insert battery
		Battery is defective	Replace battery
		Faulty electronic component	Send in the instrument for repair.
Tip drips/ instrument not sealed or volume error	—	Improper tip	Only use quality tips
		Tip is not properly seated	Press tip in firmly/use other ejector-adjustment clips.
		Piston, nose cone or seal is contaminated or damaged	Clean the instrument/ replace the seal. Grease piston.
Display is dark		Electrostatic discharge	Remove and insert the battery.
		Faulty electronic component	Send in the instrument for repair.

## Transferpette® electronic

Volume	0.5-10 µl	2-20 µl	10-200 µl	50-1000 µl	250-5000 µl
<b>with AC adapter (110-240V/50-60 Hz)</b>	Cat. No.	Cat. No.	Cat. No.	Cat. No.	Cat. No.
for Continental Europe	7052 99	7053 00	7053 03	7053 06	7053 07
for UK/Ireland	7053 09	7053 10	7053 13	7053 16	7053 17
for USA/Japan	7053 19	7053 20	7053 23	7053 26	7053 27
for Australia	7053 29	7053 30	7053 33	7053 36	7053 37
<b>without AC adapter</b>	7053 39	7053 40	7053 43	7053 46	7053 47

## AC adapters (110-240V/50-60 Hz)

	Cat. No.
for Continental Europe	7053 50
for UK/Ireland	7053 51
for USA/Japan	7053 52
for Australia	7053 53

## 3-instrument stand with AC adapter for 3 Transferpette® electronic up to 1000 µl

with AC adapter (110-240V/50-60 Hz)	Cat. No.
for Continental Europe	7053 90
for UK/Ireland	7053 91
for USA/Japan	7053 92
for Australia	7053 93

## Replacement battery

for Transferpette® electronic

<b>Cat. No.</b>	7055 00
-----------------	---------

## Silicon grease

for Transferpette® electronic up to 1000 µl

<b>Cat. No.</b>	7055 02
-----------------	---------

## Silicon grease

for Transferpette® electronic 250 - 5000 µl

<b>Cat. No.</b>	7036 77
-----------------	---------

## Quality pipette tips from BRAND, non-sterile, PP

Volume	Pack of	Cat. No.
<b>bulk packed</b>		
0.1 - 20 µl	2000	7320 02
0.5 - 20 µl	2000	7320 04
1 - 50 µl	2000	7320 06
2 - 200 µl	1000	7320 08
50 - 1000 µl	1000	7320 12
5 ml	200	7025 95
5 ml	1000	7026 00
<b>5 ml Tip-Box</b>	1 box of 28	7026 05

## PLT unit

Pipette leak testing unit

<b>Cat. No.</b>	7039 70
-----------------	---------

## Filter for Transferpette® electronic

5 ml, pack of 25

<b>Cat. No.</b>	7046 52
-----------------	---------

## Spare parts for Transferpette® electronic up to 1000 µl

Parts will differ slightly depending on nominal volume of instrument. (Fig. shows spare parts for Transferpette® electronic 10 - 200 µl).

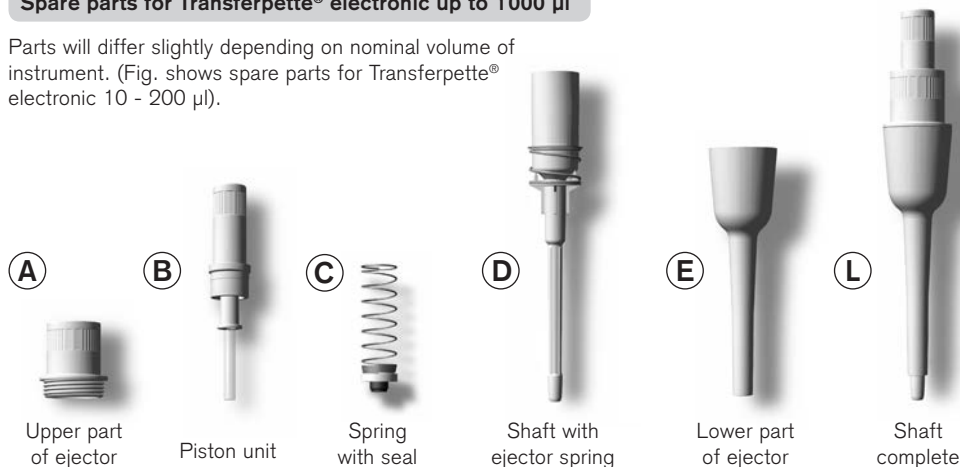

Volume	A	B	C	D	E	L
0.5 - 10 µl	7055 10	7055 18	–	7055 38	7055 48	7055 28
2 - 20 µl	7055 10	7055 20	7055 30	7055 39	7055 50	7055 29
10 - 200 µl	7055 10	7055 22	7055 32	7055 37	7055 53	7055 46
50 - 1000 µl	7055 10	7055 24	7055 34	7055 41	7055 55	7055 47

## Spare parts for Transferpette® electronic 250-5000 µl

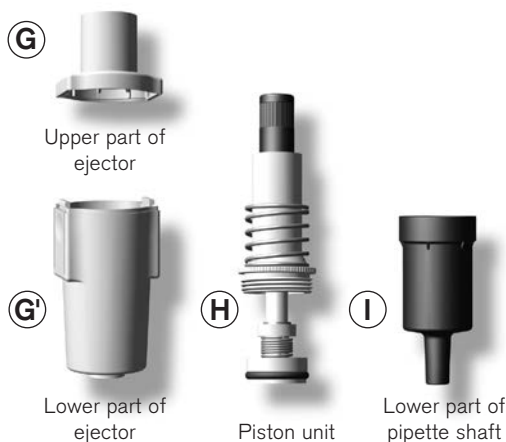

## Accessories for Transferpette® electronic 10-200 µl and 50-1000 µl

Mountable ejector adjustment clips (spacers) (F) and pipette shafts (K) with flexible tip cone enable optimized fitting accuracy and minimized ejection forces with most commonly available pipette tips.

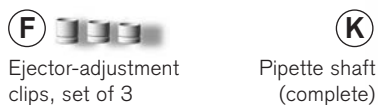

Volume	G + G'	H	I
250 - 5000 µl	7299	7055 26	7032 47

Volume	F	K
10 - 200 µl	7055 60	7055 43
50 - 1000 µl	7055 62	7055 45

## Return for repair

**Important!** Transporting of hazardous materials without a permit is a violation of federal law.

- Clean and decontaminate the instrument carefully.
- It is essential always to include an exact description of the type of malfunction and the media used. If information regarding media used is missing, the instrument cannot be repaired.
- Shipment is at the risk and the cost of the sender.

### Outside the U.S. and Canada:

- Complete the "Declaration on Absence of Health Hazards" and send the instrument to the manufacturer or supplier. Ask your supplier or manufacturer for the form. The form can also be downloaded from [www.brand.de](http://www.brand.de).

### In the U.S. and Canada:

- Contact BrandTech Scientific, Inc. and obtain authorization for the return **before** sending your instrument for service.
- Return only cleaned and decontaminated instruments, with the Return Authorization Number prominently displayed on the outside of the package to the address provided with the Return Authorization Number.

## Contact addresses

### BRAND GMBH + CO KG

Otto-Schott-Straße 25  
97877 Wertheim (Germany)  
Tel.: +49 9342 808-0  
Fax: +49 9342 808-98000  
E-Mail: [info@brand.de](mailto:info@brand.de)  
[www.brand.de](http://www.brand.de)

### USA and Canada:

BrandTech® Scientific, Inc.  
11 Bokum Road  
Essex, CT 06426-1506 (USA)  
Tel.: +1-860-767 2562  
Fax: +1-860-767 2563  
[www.brandtech.com](http://www.brandtech.com)

### India:

BRAND Scientific Equipment Pvt. Ltd.  
303, 3rd Floor, 'C' Wing, Delphi  
Hiranandani Business Park, Powai  
Mumbai - 400 076 (India)  
Tel.: +91 22 42957790  
Fax: +91 22 42957791  
E-Mail: [info@brand.co.in](mailto:info@brand.co.in)  
[www.brand.co.in](http://www.brand.co.in)

### China:

BRAND (Shanghai) Trading Co., Ltd.  
Guangqi Culture Plaza  
Room 506, Building B  
No. 2899, Xietu Road  
Shanghai 200030 (P.R. China)  
Tel.: +86 21 6422 2318  
Fax: +86 21 6422 2268  
E-Mail: [info@brand.cn.com](mailto:info@brand.cn.com)  
[www.brand.cn.com](http://www.brand.cn.com)

### Calibration Service

ISO 9001 and GLP-guidelines require regular examinations of your volumetric instruments. We recommend checking the volume every 3-12 months. The interval depends on the specific requirements on the instrument. For instruments frequently used or in use with aggressive media, the interval should be shorter. The detailed testing instruction can be downloaded on [www.brand.de](http://www.brand.de) or [www.brandtech.com](http://www.brandtech.com).

BRAND also offers you the possibility to have your instruments calibrated by the BRAND Calibration Service or the BRAND-owned DAkKS Calibration Service.

Just send in the instruments to be calibrated, accompanied by an indication of which kind of calibration you wish. Your instruments will be returned within a few days together with a test report (BRAND Calibration Service) or with a DAkKS Calibration Certificate. For further information, please contact your dealer or BRAND. Complete ordering information is available for download at [www.brand.de](http://www.brand.de) (see Technical Documentation).

## Warranty

We shall not be liable for the consequences of improper handling, use, servicing, operating or unauthorized repairs of the instrument or the consequences of normal wear and tear especially of wearing parts such as pistons, seals, valves and the breakage of glass as well as the failure to follow the instructions of the operating manual. We are not liable for damage resulting from any actions not described in the operating manual or if non-original spare parts or components have been used.

U.S. and Canada:  
Information for warranty please see [www.brandtech.com](http://www.brandtech.com).

## Disposal

---

The adjoining symbol means that storage batteries and electronic devices must be disposed of separately from household trash (mixed municipal waste) at the end of their service life.

- According to the Directive 2002/96/EC of the European Parliament and of the Council on Waste Electrical and Electronic Equipment (WEEE) of 27 January 2003, electronic equipment requires disposal according to the relevant national disposal regulations.



- Batteries contain substances that can have harmful effects on the environment and human health. Therefore according to the Directive 2006/66/EC of the European Parliament and the Council on Waste Batteries of 6 September 2006 batteries require disposal according to the relevant national disposal regulations. Dispose of batteries only when completely discharged.

**Warning!** Do not short-circuit the battery to discharge it!

	Page
Règles de sécurité	72
Fonction et limites d'emploi	73
Interdictions d'emploi	73
Les éléments de commande	74
<b>Premiers pas</b>	<b>75</b>
Réglage du volume	76
Réglage de la vitesse d'aspiration et d'éjection	77
Le pipetage correct	78
Les programmes de pipetage	79
Mode PIP	80
Mode PIPmix	82
Mode revPIP	84
Mode électrophorèse (GEL)	86
Mode DISP	88
Contrôle du volume	90
Table de précision	91
<b>Easy Calibration (ajustage)</b>	<b>92</b>
Autoclavage	94
Course d'essai (rEF)	94
Entretien et nettoyage	95
Recharge et remplacement de la pile	97
Fonction de régénération de la pile	98
Dérangement – que faire?	99
Données de commande · Accessoires · Pièces de rechange	100
Réparation · Adresses de contact	102
Service de calibration	103
Garantie · Elimination	104

## Règles de sécurité

Cet appareil peut être utilisé avec des matériaux dangereux ou en relation avec des appareillages ou procédés dangereux. Le livret de mode d'emploi cependant n'a pas pour but d'exposer tous les problèmes de sécurité pouvant en résulter. Ce sera donc de la responsabilité de l'utilisateur d'être sûr que les consignes de sécurité et de santé seront respectées. C'est à lui de déterminer les restrictions correspondantes avant l'emploi de l'appareil.

### A lire attentivement

1. Chaque utilisateur doit avoir lu ce livret mode d'emploi avant l'emploi de l'appareil et en observer les instructions.
2. Tenir compte des avertissements de danger et suivre les règles de sécurité générales, comme par ex. en portant des vêtements de protection, protection des yeux et des mains.  
Lors de travaux avec des échantillons infectieux ou dangereux, les consignes ainsi que les mesures de précaution standards en vigueur dans les laboratoires doivent être observées.
3. Observer les données des fabricants de réactif.
4. Ne pas utiliser l'appareil dans une atmosphère pouvant provoquer des explosions. Des milieux facilement inflammables ne doivent pas être pipetés.
5. Employer uniquement l'appareil pour le pipetage de liquides en observant les limites d'emploi et les interdictions (voir page 73). En cas de doute, se renseigner auprès du fabricant et/ou du fournisseur.
6. Toujours travailler de façon à ne mettre en danger ni vous-même ni autrui. Éviter les éclaboussures. Utiliser uniquement des récipients appropriés.
7. Éviter tout contact avec les orifices des pointes lors de travaux avec des fluides agressifs.
8. Ne jamais employer la force.
9. Employer uniquement les pièces de rechange originaux. Ne pas effectuer de modifications techniques. Ne pas démonter l'appareil plus que ce qui est indiqué dans le mode d'emploi
10. Avant l'utilisation vérifier l'état correct de l'instrument. Si des dérangements se manifestent (par ex. piston grippé, soupapes collées, non-étanchéités), arrêter immédiatement la titration et consulter le chapitre 'Dérangement, que faire?' (voir page 99). Si besoin est, contacter le fabricant.
11. Ne pas remplacer l'accu original par des accus non rechargeables ou rechargeables d'autres fabricants.
12. Pour recharger les piles nickel-métal-hydrure, employer uniquement le bloc d'alimentation original.
13. Le bloc d'alimentation doit être protégé de l'humidité et ne doit être utilisé que pour cet appareil.
14. N'éliminer l'accu que quand il est déchargé complètement, et conformément au règlement en vigueur pour votre pays.

### Avertissement

Une manipulation incorrecte de l'appareil ou de la pile (court-circuit, destruction mécanique, surchauffe, bloc d'alimentation incorrect, etc.) peut, dans les situations extrêmes, occasionner l'explosion de la pile.



La Transferpette® electronic est une pipette à piston conformément au principe du coussin d'air commandée par microprocesseur elle fonctionne à l'aide de piles permettant de pipeter les solutions aqueuses de densité et de viscosité moyennes.

Dans la mesure où l'appareil est manipulé correctement, l'échantillon à doser entrera uniquement en contact avec la pointe et non pas avec la Transferpette® electronic.

### Limites d'emploi

Cet appareil a été conçu pour le pipetage d'échantillons sous réserve des limites suivantes:

- température de emploi de +15 °C à +40 °C (de 59 °F à 104 °F) (sur demande, appareil et réactifs pour d'autres plages de température)
- pression de vapeur jusqu'à 500 mbar
- viscosité: 260 mPa s

### Interdictions d'emploi

C'est à l'utilisateur de vérifier si l'appareil est approprié pour l'emploi qu'il veut en faire.

Ne jamais employer l'appareil afin de pipeter les liquides attaquant les polypropylènes (tige et pointes), le polybutènetéréphtalate de polycarbonate (boîtier) ou EPDM (tiges de pipette de rechange flexibles). Éviter l'exposition aux vapeurs agressives (risque de corrosion)!

La partie poignée n'est pas autoclavable.

### Restrictions d'emploi

Les liquides visqueux ou mouillants peuvent influencer l'exactitude du volume. De même pour les liquides dont la température diffère de plus  $\pm 5$  °C/ 41 °F de la température ambiante.

### Spécifications pile et bloc d'alimentation

#### Pile

Pile nickel-métal-hydrure avec 3 cellules cylindriques individuelles au format AAA, 3,6 V, 700 mAh

#### Bloc d'alimentation

Tension de sortie 6,5 V DC, 200 mA

## Les éléments de commande

La Transferpette® electronic est une pipette à piston commandée par microprocesseur et fonctionnant sur pile, optimisée pour l'ergonomie de manipulation et la simplification du travail.

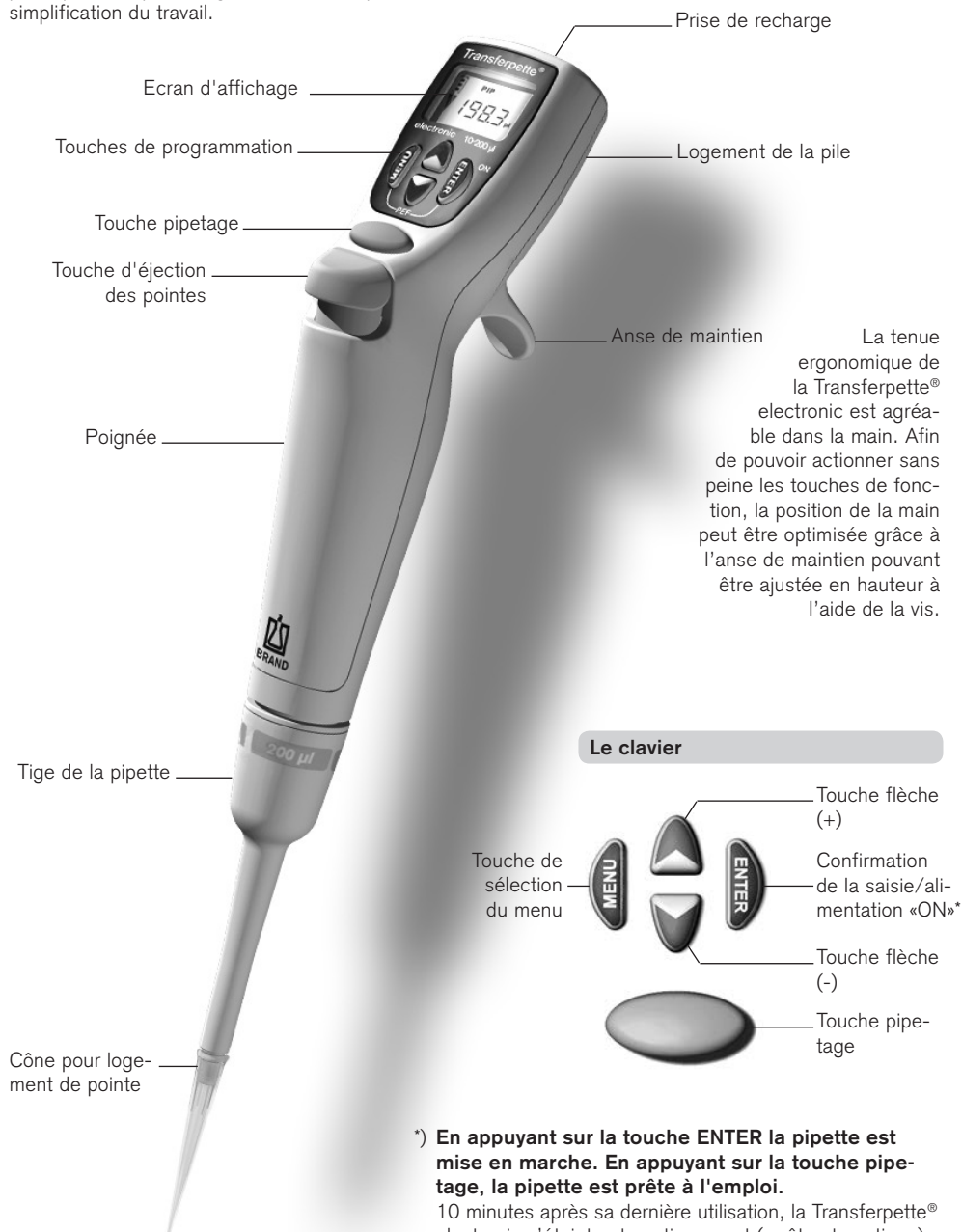

## Contenu de la livraison

L'emballage contient une Transferpette® electronic, une pile, le bloc d'alimentation avec câble de recharge de la pile, de l'huile de silicone, le présent mode d'emploi ainsi qu'un sachet d'échantillons de pointes de pipettes.

### Mise en service de la Transferpette® electronic

#### 1. Mise en place de la pile

a) Ouvrir le couvercle du logement de la pile.



b) Insérer une pile neuve. Veillez à ce que le connecteur de la pile soit bien enfoncé dans la prise de l'appareil.



c) Remettre le couvercle du logement de la pile en place puis le fermer.



#### 2. Activation de l'appareil

Directement après la mise en place de la pile, la Transferpette® electronic demande automatiquement une course de référence. Pour effectuer la course de référence, il suffit d'appuyer sur la touche de pipetage et l'appareil est prêt à l'emploi.

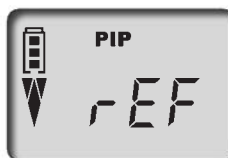

L'écran affiche le mode de pipetage par défaut programmé en usine (PIP) ainsi que le volume nominal (ici, 200,0 µl par ex.). Les vitesses d'aspiration et d'éjection sont réglées au maximum en usine. Le réglage simple du volume et de la vitesse est expliqué sur les pages suivantes.

Mode de pipetage

Indicateur du niveau de charge de la pile







Symbole «d'aspiration»

Indication du volume

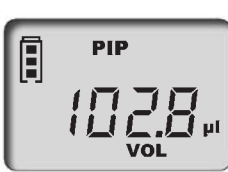

## Réglage du volume

Le volume nominal correspondant de la Transferpette® electronic a été ajusté en usine et se laisse facilement et rapidement modifier de manière individuelle.

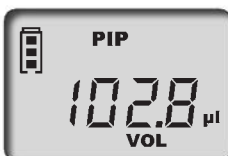
Que dois-je faire?	Comment procéder?	Quelle touche?	Qu'affiche l'écran?
<b>1. Activation de la sélection du volume</b>	Il suffit d'appuyer sur l'une des touches flèches afin de pouvoir directement sélectionner un volume. «VOL» clignote.		
<b>2. Réglage du volume</b>			
<b>Diminution</b>	Pour diminuer le volume, il suffit d'appuyer sur la touche flèche (-). Une pression prolongée augmente la vitesse de défilement du volume. «VOL» clignote toujours.		
<b>Augmentation</b>	Pour augmenter le volume, il suffit d'appuyer sur la touche flèche (+). Une pression prolongée augmente la vitesse de défilement du volume. «VOL» clignote toujours.		
<b>3. Confirmation du volume sélectionné</b>	Appuyer sur la touche ENTER. L'écran affiche alors le nouveau volume programmé. Dans l'exemple ci-contre, l'écran affiche le mode PIP programmé par défaut.		

### Important:













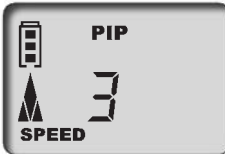

Chaque procédure de réglage peut être interrompue en actionnant la touche MENU. L'affichage passe alors à l'opportunité de réglage suivante ou à l'écran de départ.

# Réglage de la vitesse d'aspiration et d'éjection

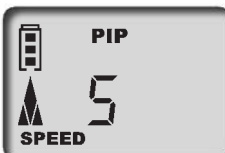











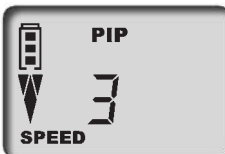

La vitesse d'aspiration et la vitesse d'éjection peuvent être réglées séparément. Lors de l'appel du menu, la dernière vitesse programmée s'affiche. 5 vitesses sont disponibles.

Que dois-je faire?	Comment procéder?	Quelle touche?	Qu'affiche l'écran?
--------------------	-------------------	----------------	---------------------

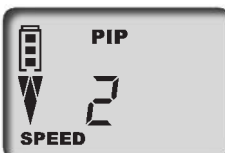
## Réglage de la vitesse d'aspiration

- |  |   |  |  |
|--|---|--|--|
| <b>1. Appel du menu</b>                      | Pour accéder au menu de la vitesse d'aspiration, appuyer brièvement sur la touche MENU.<br>«Speed» clignote.  | 1x<br><br><br><br> |  |
| <b>2. Réglage de la vitesse d'aspiration</b> | La vitesse peut être sélectionnée à l'aide des touches flèches (+/-) (niveau 5, par ex.). «Speed» clignote toujours.  | <br><br><br>       |  |
| <b>3. Confirmation du niveau de vitesse</b>  | Appuyer sur la touche ENTER. L'affichage retourne à l'écran initial du mode programmé. Dans l'exemple ci-contre, il s'agit de l'affichage du mode PIP programmé par défaut, par ex. | <br><br><br>1x<br> |  |

## Réglage de la vitesse d'éjection

- |   |   |  |  |
|---|---|--|--|
| <b>1. Appel du menu</b>                     | Pour accéder au menu de la vitesse d'éjection, appuyer brièvement sur la touche MENU.<br>«Speed» clignote.  | 2x<br><br><br><br>    |   |
| <b>2. Confirmation du niveau de vitesse</b> | Appuyer sur la touche ENTER. L'affichage retourne à l'écran initial du mode programmé. Dans l'exemple ci-contre, il s'agit de l'affichage du mode PIP programmé par défaut p. ex.   | <br><br><br>       |  |
| <b>3. Confirmation du niveau de vitesse</b> | Appuyer sur la touche ENTER. L'affichage retourne à l'écran initial du mode programmé. Dans l'exemple ci-contre, il s'agit de l'affichage du mode PIP programmé par défaut, par ex. | <br><br><br>1x<br> |  |

Le volume nominal correspondant de la Transferpette® electronic a été ajusté en usine et se laisse facilement et rapidement modifier de manière individuelle (voir page 76).

## Démarrage rapide avec le mode de pipetage par défaut

### 1. Insertion d'une pointe

N'utiliser que de pointe appropriée correspondant au volume ou au code couleur! Veiller à l'étanchéité et à la mise en place correcte de pointe. En cas d'utilisation de la tige de pipette flexible, monter si nécessaire un clip interchangeable différent. Les pointes de pipette sont des articles à usage unique.

### 2. Aspiration de liquide



Tenir l'appareil à la verticale et immerger la pointe 2 à 3 mm dans le liquide.

Pour aspirer le liquide, il suffit d'actionner la touche pipetage. La flèche sur l'écran pointe vers le haut (aspiration).



1x

**Remarque:** Afin de ne pas aspirer d'air, laisser encore la pointe immergée durant env. 1 s

### 3. Ejection du liquide

Après avoir aspiré un liquide, la flèche sur l'écran pointe vers le bas (éjection).

Placer la pointe de la pipette contre la paroi du récipient. La tenir inclinée en respectant un angle compris entre 30 et 45°.

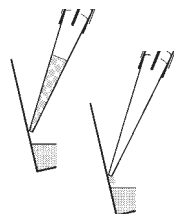

En appuyant à nouveau sur la touche pipetage, le liquide est intégralement éjecté par le biais d'un dépassement de course automatique. Tirer la pointe de la pipette contre la paroi du récipient.



1x

### 4. Mise au rebut de la pointe



Tenir la tige de la pipette au-dessus d'un collecteur de déchets approprié puis enfoncer la touche éjection de pointe.

Touche éjection de pointe









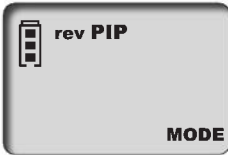

**Remarque:**

La norme ISO 8655 prescrit de rincer la pointe de pipette avec le liquide d'essai avant l'opération de pipetage elle-même.

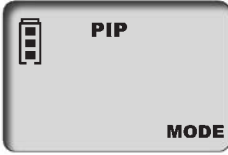
	Page
<b>1. Pipetage normal</b>	
Mode <b>PIP</b>	<b>80</b>
Programme par défaut. Un volume programmé préalablement est aspiré puis éjecté.	
<b>2. Dispersion de l'échantillon</b>	
Mode <b>PIPMix</b>	<b>82</b>
Programme permettant de mélanger les liquides. L'échantillon est aspiré puis éjecté à plusieurs reprises.	
<b>3. Pipetage inverse</b>	
Mode <b>revPIP</b>	<b>84</b>
Programme conçu pour le pipetage de liquides à viscosité élevée, à tension de vapeur élevée ou les fluides moussants.	
<b>4. Pipetage électrophorèse</b>	
Mode <b>GEL</b>	<b>86</b>
Programme permettant de charger les gels électrophorèse. Un volume défini au préalable de l'échantillon est aspiré à vitesse constante et rapide avant d'être lentement éjecté.	
<b>5. Distribution</b>	
Mode <b>DISP</b>	<b>88</b>
Programme permettant la distribution d'un volume de liquide en plusieurs fractions.	

Le mode GEL n'est pas disponible avec la Transferpette® electronic 1000 µl et 5000 µl.

Le programme par défaut, un volume programmé auparavant est aspiré puis éjecté. Le réglage du volume et de la vitesse sont décrits en pages 76 et 77.

Que dois-je faire?	Comment procéder?	Quelle touche?	Qu'affiche l'écran?
1. Appel de la sélection du menu	Pour accéder à la sélection du programme, il suffit d'appuyer trois fois sur la touche MENU. «Mode» clignote.	3x 	
2. Réglage du mode PIP	Faire défiler les modes à l'aide des touches fleches jusqu'à ce que «PIP» s'affiche. «Mode» clignote toujours.		
3. Confirmation du mode PIP	Appuyer sur la touche ENTER. L'écran affiche maintenant «blo» pour «blow-out» (dépassement de course).	 1x	
4. Préparation du pipetage	En appuyant une fois sur la touche pipetage, le piston est avancé en écran initial. La flèche sur l'écran pointe vers le haut (aspiration).	 1x	
5. Aspiration du liquide	Pour aspirer le liquide, il suffit d'appuyer une fois sur la touche pipetage.	 1x	

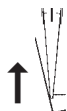



Que dois-je faire?	Comment procéder?	Quelle touche?	Qu'affiche l'écran?
--------------------	-------------------	----------------	---------------------

**6. Ejection du liquide**

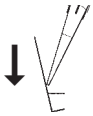

Pour éjecter le liquide, il suffit d'appuyer une fois sur la touche pipetage. La flèche sur l'écran pointe vers le bas (éjection).



**7. Déclenchement du dépassement de course?**

**Vous ne devez absolument rien faire!** Le dépassement de la course (blow-out) est entièrement automatique lors du pipetage en mode PIP!



**Déclenchement direct du blow-out**

Le cas échéant, le dépassement de course (blow-out) peut être directement déclenché.

**1. Appel de la fonction blow-out**

Appuyer sur la touche ENTER. L'écran affiche «**blo**» pour blow-out.

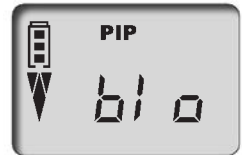

**2. Déclenchement du dépassement de course**

Pour déclencher le dépassement de course, il suffit d'appuyer une fois sur la touche pipetage. L'écran retourne au mode pipetage programmé (écran initial).









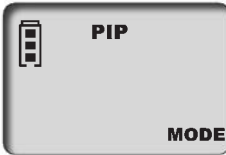

**Remarque:**

Lors du dépassement de course (blow-out), le piston descend complètement. S'assurer que le liquide résiduel peut être éjecté sans danger.

**En maintenant la touche pipetage enfoncée, le piston s'arrête en bas et empêche ainsi une aspiration accidentelle de liquide. Après l'avoir relâchée, le piston retourne en écran initial.**

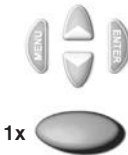
Le programme par défaut, un volume programmé auparavant est aspiré puis éjecté. Le réglage du volume et de la vitesse sont décrits en pages 76 et 77.

Que dois-je faire?	Comment procéder?	Quelle touche?	Qu'affiche l'écran?
<b>1. Appel de la sélection du menu</b>	Pour accéder à la sélection du programme, il suffit d'appuyer trois fois sur la touche MENU. « <b>Mode</b> » clignote.		
<b>2. Réglage du mode PIPmix</b>	Feuilletter les modes à l'aide des touches flèches jusqu'à ce que « <b>PIPmix</b> » s'affiche. « <b>Mode</b> » clignote toujours.		
<b>3. Confirmation du mode PIPmix</b>	Appuyer sur la touche ENTER. L'écran affiche maintenant « <b>blo</b> » pour «blow-out» (dépassement de course).		
<b>4. Préparation du pipetage</b>	En appuyant une fois sur la touche pipetage, le piston est avancé en écran initial. La flèche sur l'écran pointe vers le haut (aspiration).		
<b>5. Aspiration du liquide</b>	Pour aspirer le liquide, il suffit d'appuyer une fois sur la touche pipetage.		

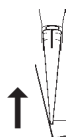

Que dois-je faire?	Comment procéder?	Quelle touche?	Qu'affiche l'écran?
--------------------	-------------------	----------------	---------------------

## 6. Ejection du liquide en mode PIPmix

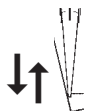

En maintenant la touche pipetage enfoncée, le liquide est aspiré puis éjecté en permanence. Sur l'écran, les flèches d'aspiration et d'éjection s'affichent en alternance avec le nombre de cycles.



maintenir enfoncée



## 7. Achèvement du pipetage

En appuyant une fois sur la touche pipetage, le liquide est éjecté et le dépassement de course est déclenché (blow-out).

Après éjection du liquide résiduel (dépassement de course), l'écran retourne au mode programmé (écran initial).













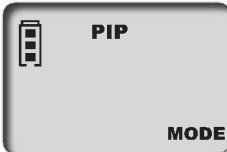

1x



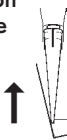







### Remarque:

L'écran affiche au maximum 19 cycles.

Programme spécial pour le pipetage liquides à viscosité élevée, à tension de pression élevée ou à fluides effervescents. Le réglage du volume et de la vitesse sont décrits en pages 76 et 77.

Que dois-je faire?	Comment procéder?	Quelle touche?	Qu'affiche l'écran?
<b>1. Appel de la sélection du menu</b>	Pour accéder à la sélection du programme, il suffit d'appuyer trois fois sur la touche MENU. «Mode» clignote.	3x 	
<b>2. Réglage du mode revPIP</b>	Feuilletter les modes à l'aide des touches flèches jusqu'à ce que «revPIP» s'affiche. «Mode» clignote toujours.		
<b>3. Confirmation du mode revPIP</b>	Appuyer sur la touche ENTER. L'écran affiche maintenant «blo» pour «blow-out» (dépassement de course).	 1x	
<b>4. Préparation du pipetage</b>	En appuyant une fois sur la touche pipetage, le piston est avancé en écran initial. La flèche sur l'écran pointe vers le haut (aspiration).	 1x	
<b>5. Absorption du liquide</b> 	Pour aspirer le liquide, il suffit d'appuyer une fois sur la touche pipetage.	 1x	
<b>6. Ejection du liquide en mode revPIP</b> 	Pour éjecter le liquide, appuyer une fois sur la touche pipetage. Sur l'écran, la flèche pointe vers le bas. Le volume programmé est éjecté et un quantité infime de liquide reste dans la pointe.	 1x	











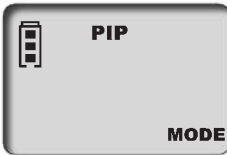

Que dois-je faire?	Comment procéder?	Quelle touche?	Qu'affiche l'écran?
<p><b>7. Réaspiration du liquide en mode revPIP</b></p> 	<p>En appuyant à nouveau sur la touche pipetage, le volume programmé est à nouveau aspiré (une nouvelle pression sur la touche pipetage et le liquide est éjecté, etc.).</p>		
<p><b>8. Déclenchement du dépassement de course</b></p>	<p>Après le dernier pipetage, appuyer sur la touche ENTER. L'écran affiche à nouveau «<b>blo</b>» pour blow-out (dépassement de course).</p>		
<p><b>9. Achèvement du pipetage</b></p>	<p>En appuyant une fois sur la touche pipetage, le dépassement de course (blow-out) est déclenché et le liquide résiduel est éjecté.</p>		
<p><b>9. Achèvement du pipetage</b></p>	<p>Après éjection du liquide résiduel (dépassement de course), l'écran retourne au mode programmé (écran initial).</p>		











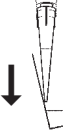

# Mode électrophorèse (GEL) Les programmes · Réglage et manipulation

Programme permettant de charger les gels électrophorèse.

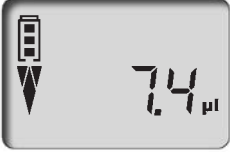
Un volume programmé au préalable est aspiré à grande vitesse puis éjecté lentement.

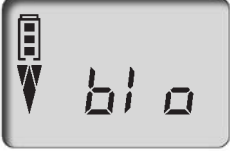
Le réglage du volume et de la vitesse sont décrits en pages 76 et 77.

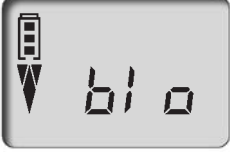







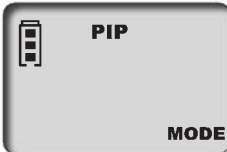

Que dois-je faire?	Comment procéder?	Quelle touche?	Qu'affiche l'écran?
1. Appel de la sélection du menu	Pour accéder à la sélection du programme, il suffit d'appuyer trois fois sur la touche MENU. «Mode» clignote.	3x 	
2. Réglage du mode GEL	Feuilleter les modes à l'aide des touches flèches jusqu'à ce que «GEL» s'affiche. «Mode» clignote toujours.		
3. Confirmation du mode GEL	Appuyer sur la touche ENTER. L'écran affiche maintenant «blo» pour «blow-out» (dépassement de course).	 1x	
4. Préparation du pipetage	En appuyant une fois sur la touche pipetage, le piston est avancé en écran initial. La flèche sur l'écran pointe vers le haut (aspiration).	 1x	
5. Aspiration du liquide	Pour aspirer le liquide, il suffit d'appuyer une fois sur la touche pipetage. Le volume programmé est alors aspiré.	 1x	
	<b>Aspiration d'un volume supérieur</b> Afin d'aspirer plus de liquide que programmé (jusqu'à 110 % du volume nominal), maintenir la touche pipetage enfoncée durant l'aspiration jusqu'à ce que le volume souhaité ait été aspiré.	 maintenir enfoncée	

Que dois-je faire?	Comment procéder?	Quelle touche?	Qu'affiche l'écran?
<p><b>6. Ejection du liquide en mode GEL</b></p> 	<p>Afin d'éjecter le liquide, appuyer un court instant sur la touche pipetage, un dièse s'affiche sur l'écran. Le volume programmé est lentement éjecté.</p> <p><b>Interrompre l'éjection</b> L'éjection de l'échantillon peut être interrompue en appuyant à nouveau sur la touche pipetage. L'écran affiche alors le volume de liquide éjecté.</p>	 <p>1x </p>	
		 <p>1x </p>	
<p><b>7. Déclenchement du dépassement de course</b></p>	<p>Après le dernier pipetage, appuyer sur la touche ENTER. L'écran affiche à nouveau «blo» pour blow-out (dépassement de course).</p>	 <p>1x </p>	
	<p>En appuyant une fois sur la touche pipetage, le dépassement de course (blow-out) est déclenché et le liquide résiduel est éjecté.</p>	 <p>1x </p>	
<p><b>8. Achèvement du pipetage</b></p>	<p>Après éjection du liquide résiduel (dépassement de course), l'écran retourne au mode programmé (écran initial).</p>		

**Remarque:**

Le mode GEL implique la mise en œuvre d'une très lente éjection afin d'éviter de soumettre les échantillons à des tourbillonnements. Afin de garantir une éjection optimale, la vitesse d'éjection a été réglée en usine. Elle est nettement plus lente que la vitesse 1 et ne peut pas être sélectionnée individuellement.

Programme permettant la distribution d'un volume de liquide en plusieurs fractions.  
Il y a plus de liquide aspiré que nécessaire selon le calcul.  
Le réglage de la vitesse est décrit en page 77.

Que dois-je faire?	Comment procéder?	Quelle touche?	Qu'affiche l'écran?
1. Appel de la sélection du menu	Pour accéder à la sélection du programme, il suffit d'appuyer trois fois sur la touche MENU. «Mode» clignote.	3x 	
2. Réglage du mode DISP	Feuilleter les modes à l'aide des touches flèches jusqu'à ce que «DISP» s'affiche. «Mode» clignote toujours.		
3. Confirmation du mode DISP	Appuyer sur la touche ENTER. L'écran affiche maintenant «blo» pour «blow-out» (dépassement de course).	 1x	
4. Préparation du dosage	En appuyant une fois sur la touche pipetage, le piston est avancé en écran initial. La flèche sur l'écran pointe vers le haut (aspiration).	 1x	
5. Réglage du volume de la fraction	Pour augmenter le volume, il suffit d'appuyer sur la touche flèche (+). Une pression prolongée augmente la vitesse de défilement du volume. «VOL» clignote toujours.		
6. Confirmation du volume de la fraction	Appuyer sur la touche ENTER. L'écran affiche le nouveau volume de la fraction programmé. «steps» clignote. Le nombre maximal de fractions s'affiche.	 1x	



Que dois-je faire?	Comment procéder?	Quelle touche?	Qu'affiche l'écran?
7. Réglage du nombre de fractions	En appuyant sur la touche (+/-) on peut régler le nombre de fractions. «steps» clignote toujours.		
8. Confirmation du nombre de fractions	Appuyer sur la touche ENTER. L'écran affiche le nombre de fractions.		
9. Aspiration du liquide	Pour aspirer le liquide, il suffit d'appuyer une fois sur la touche pipetage.		
10. Ejection du liquide	En appuyant la touche pipetage une fraction est éjectée. La flèche sur l'écran pointe vers le bas (éjection). Le nombre de fractions disponibles s'affiche.		
11. Déclenchement du dépassement de course	Après la dernière distribution, appuyer sur la touche ENTER. L'écran affiche «blo» pour blow-out (dépassement de course). En appuyant une fois sur la touche pipetage, le dépassement de course est déclenché (voir page 87).		
12. Achèvement du dosage	Après éjection du liquide résiduel (dépassement de course), l'écran retourne au mode programmé (écran initial).		

# Contrôle du volume

En fonction de l'usage, nous recommandons de faire contrôler l'appareil tous les 3 à 12 mois. Mais le cycle peut être adapté aux exigences individuelles.

L'essai volumétrique gravimétrique des pipettes s'effectue de la manière suivante et satisfait aux exigences de la 6<sup>ème</sup> partie de la norme DIN EN ISO 8655.

## 1. Réglage du volume nominal

Mettre au volume maximum de l'appareil.  
Déroulement, voir page 76.

## 2. Conditionnement de la pipette

Conditionner la pipette avant l'essai en aspirant et éjectant cinq fois le liquide d'essai (H<sub>2</sub>O dist.) à l'aide de la pointe de la pipette. Jeter ensuite la pointe de la pipette.

## 3. Réalisation de l'essai

- Insérer une nouvelle pointe sur la pipette et la rincer une fois à l'aide du liquide d'essai.
- Aspirer le liquide puis l'éjecter dans le récipient de pesée.
- Peser ensuite la quantité pipetée à l'aide d'une balance chimique (veuillez observer le mode d'emploi du fabricant de la balance).
- Calculer le volume pipeté. Tenir compte de la température.
- Il est recommandé d'effectuer au minimum 10 pipetages et pesées dans 3 plages de volume (100 %, 50 %, 10 %).

### Calcul (volume nominal)

$x_i$  = résultats des pesages  
 $n$  = nombre de pesages

$Z$  = facteur de correction  
(par ex. 1,0029 µl/mg à 20 °C, 1013 hPa)

Valeur moyenne  $\bar{x} = \frac{\sum x_i}{n}$

Volume moyen  $\bar{V} = \bar{x} \cdot Z$

#### Exactitude\*

$$E\% = \frac{\bar{V} - V_0}{V_0} \cdot 100$$

$V_0$  = volume nominal

#### Déviatiion standard

$$s = Z \cdot \sqrt{\frac{\sum (x_i - \bar{x})^2}{n - 1}}$$

#### Coefficient de variation\*

$$CV\% = \frac{100 \cdot s}{\bar{V}}$$

\*) = calcul de l'exactitude (E%) et du coefficient de variation (CV%):

E% et CV% seront calculés selon les formules utilisés pour le contrôle statistique de qualité.

## Table de précision

Les valeurs d'essai finales se rapportent au volume nominal imprimé sur l'appareil (= volume maxi) et aux volumes de la fraction indiqués à température identique (20 °C/68 °F) de l'appareil, de l'environnement et de l'eau distillée Conformément aux exigences de la norme DIN EN ISO 8655.



20 °C  
Ex

### Précision de la Transferpette® electronic

Gamme de volume µl	Volume de la fraction µl	E* ≤ ± %	CV* ≤ %	Pas inter-médiares µl	Type de pointe rec., µl
0,5 - 10	10	1,0	0,4	0,01	0,5 - 20
	5	1,5	0,8		
	1	5,0	2,0		
2 - 20	20	1,0	0,4	0,02	0,5 - 20
	10	1,5	0,8		
	2	5,0	2,5		
10 - 200	200	0,8	0,2	0,2	2 - 200
	100	1,2	0,3		
	20	4,0	0,6		
50 - 1000	1000	0,6	0,2	1,0	50 - 1000
	500	1,0	0,3		
	100	3,0	0,6		
250 - 5000	5000	0,6	0,2	5,0	500 - 5000
	2500	1,0	0,3		
	500	3,0	0,6		

\* E = exactitude, CV = coefficient de variation

#### Remarque:

L'appareil est conforme à la d'étalonnage et de mesure allemande ainsi qu'aux normes d'étalonnage et de mesure:

**DE-M** 19

La texte DE-M (DE pour Allemagne), encadrée par un rectangle, ainsi que les deux derniers chiffres de l'année au cours de laquelle le marquage a été apposé (ici: 2019).

#### Remarque:

Des instructions de contrôle (SOPs) et une version de démonstration du logiciel de calibrage EASYCAL™ 4.0 peuvent être téléchargées sur le site [www.brand.de](http://www.brand.de).

## Le mode d'ajustage «CAL»

### Ajustage

Le volume nominal, resp. le volume à contrôler, est programmé. Pipetage en mode par défaut (PIP), 200,0 µl, par ex. (procédure, voir pages 76, 80).  
Par. ex.: volume en relation avec l'essai volumétrique 201,3 µl.



Que dois-je faire?	Comment procéder?	Quelle touche?	Qu'affiche l'écran?
1. Appel du mode CAL	Pour appeler le mode CAL, il suffit de maintenir la touche MENU enfoncée (> 3 s). L'écran affiche «off». «CAL» clignote.	1x >3s 	
2. Activation du mode CAL	Le mode CAL s'active en appuyant sur l'une des touches flèches. L'écran affiche alors «on». «CAL» clignote toujours.		
3. Confirmation du mode CAL	Appuyer sur la touche ENTER. L'écran affiche ensuite à nouveau le volume de pipetage programmé. «CAL» clignote.	1x	
4. Réglage du volume	Régler le volume déterminé et contrôlé à l'aide des touches flèches (+/-). «CAL» clignote.		
5. Confirmation du volume	Appuyer sur la touche ENTER. Le volume contrôlé et corrigé s'affiche sur l'écran. Le symbole CAL affiché en permanence atteste de l'ajustage effectué.	1x	

## Restauration de l'état à la livraison

Le symbole CAL affiché en permanence sur l'écran signale la présence d'un ajustage.



### Que dois-je faire?

### Comment procéder?

### Quelle touche?

### Qu'affiche l'écran?

#### 1. Appel du mode CAL

Pour appeler le mode CAL, il suffit de maintenir la touche MENU enfoncée (> 3 s). L'écran affiche «on». «CAL» clignote.

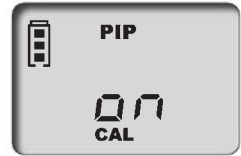
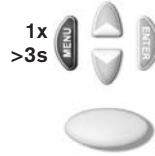

#### 2. Désactivation du mode CAL

Le mode CAL se désactive en appuyant sur l'une des touches flèches. L'écran affiche alors «off». «CAL» clignote toujours.



#### 3. Restauration de l'état à la livraison

Appuyer sur la touche ENTER. Le symbole CAL affiché en permanence s'est effacé. L'appareil se trouve de nouveau à l'état de livraison.



### Important:

Lors de l'ajustage de la Transferpette® electronic, un offset de volume est réalisé. Cela signifie que le volume se modifie d'autant dans l'ensemble de la plage de volume de la pipette. Il est recommandé d'effectuer l'ajustage à 50 % du volume nominal.

### Remarque:

Cet appareil est ajusté en permanence pour les solutions aqueuses mais peut également être ajusté à différentes densités, viscosités et températures. La Transferpette® electronic peut être ajustée dans tous les modes (à l'exception du mode GEL).

## Autoclavage

La tige de pipette mise en relief de la Transferpette® electronic est autoclavable à 121 °C (250 °F), 2 bar avec un durée de maintien d'au moins 15 minutes selon DIN EN 285.

**Attention:** La poignée n'est pas autoclavable!

1. Jeter la pointe de la pipette.
2. Dévisser la tige de la poignée de la pipette.
3. Autoclaver la tige complète de la pipette sans rien démonter de plus.
4. Laisser complètement refroidir et sécher la tige de la pipette.
5. Visser de nouveau la tige de la pipette sur la poignée.
6. Effectuer une course d'essai (rEF).

**Remarque:** L'efficacité de l'autoclavage doit être contrôlée par l'utilisateur. Une sécurité élevée est atteinte par stérilisation sous vide. Nous conseillons l'utilisation de poches de stérilisation.

En cas d'autoclavage fréquent de la tige de la pipette, il est recommandé de graisser le piston et le joint à la graisse de silicone fournie.

## Course de référence (rEF)

Avant de remplacer la tige de la pipette, réaliser une course d'essai. Elle permet de garantir le couplage sûr de piston.



**Que dois-je faire?**

**Comment procéder?**

**Quelle touche?**

**Qu'affiche l'écran?**

1. **Appel du mode rEF**

Pour activer le mode rEF, il suffit d'appuyer simultanément les touches MENU et ENTER.



2. **Exécution de la course d'essai**

La course d'essai se déclenche en appuyant une fois sur la touche pipetage. Un bruit est nettement audible.



**Remarque:** Après la course d'essai, l'écran affiche automatiquement le programme sélectionné auparavant.

Afin de fonctionner parfaitement, la Transferpette® electronic doit être entretenue et, le cas échéant, nettoyée à intervalles réguliers.

### Entretien

Contrôler l'absence de détérioration au niveau du cône pour le logement de la pointe.

Contrôler la propreté du piston et du joint d'étanchéité.

Contrôlez l'étanchéité de l'appareil. Nous conseillons employer l'appareil de contrôle d'étanchéité BRAND PLT unit. Alternatif: pour ce faire, aspirer l'échantillon puis tenir l'appareil à la verticale pendant env. 10 s. Lorsqu'une goutte se forme à l'extrémité de la pointe de la pipette: consulter la section «Dérangement – que faire?» en page 99.

### Démontage et nettoyage

1. Dévisser la tige de la pipette (S) de la poignée.
  2. Interrompre la liaison magnétique en tirant les deux composants.
  3. Dévisser la partie supérieure de l'éjecteur (A) de la tige de la pipette.
  4. Retirer la tige de la pipette (D et B) de la partie inférieure de l'éjecteur (E).
  5. Dévisser la douille de retenue (B).
- Remarque:** Le piston et son guide restent reliés à la douille de retenue (B).
6. Retirer le ressort avec le joint d'étanchéité (C).
  7. Nettoyer les pièces représentées à l'aide d'une solution savonneuse ou d'isopropanol puis les rincer à l'eau distillée.
  8. Sécher les pièces (120 °C/248 °F maxi).
  9. Finement graisser le piston.
  10. Remonter les pièces refroidies dans l'ordre inverse. Uniquement serrer la douille de retenue et la partie supérieure de l'éjecteur (A, B) à la main.
  11. Effectuer la course d'essai (rEF).

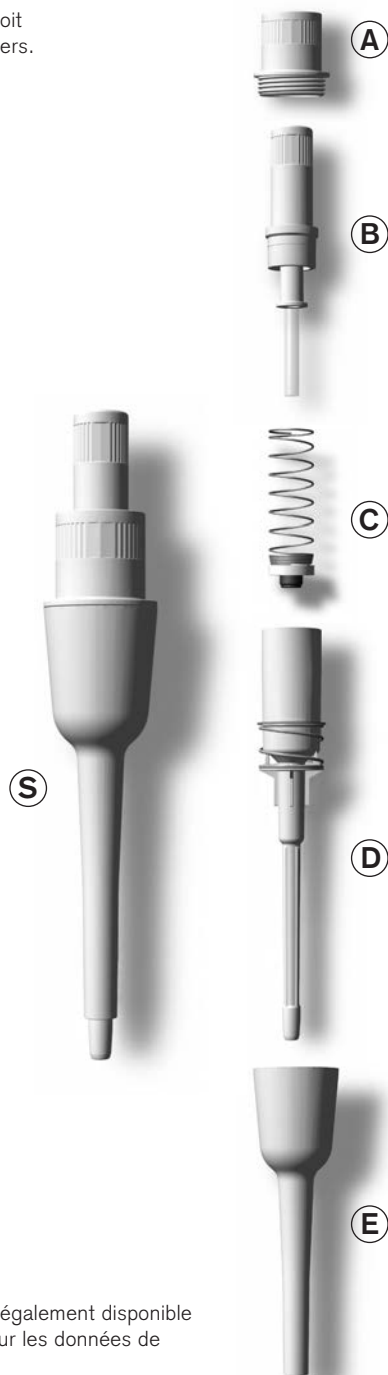

**Remarque:** L'ensemble des composants représentés est également disponible comme pièce de rechange (voir page 101 pour les données de commande).

Afin de fonctionner parfaitement, la Transferpette® electronic doit être entretenue et, le cas échéant, nettoyée à intervalles réguliers.

### Entretien

Contrôler l'absence de détérioration au niveau du cône pour le logement de la pointe.

Contrôler la propreté du piston et du joint d'étanchéité.

Contrôlez l'étanchéité de l'appareil. Nous conseillons employer l'appareil de contrôle d'étanchéité BRAND PLT unit. Alternatif: pour ce faire, aspirer l'échantillon puis tenir l'appareil à la verticale pendant env. 10 s. Lorsqu'une goutte se forme à l'extrémité de la pointe de la pipette: consulter la section «Dérangement – que faire?» en page 99.

### Démontage et nettoyage

1. Appuyer en même temps sur les deux fermetures latérales (J) et retirer la partie inférieure de l'éjecteur (G').
2. Dévisser la tige de la pipette (H+I) de la poignée.
3. Interrompre la liaison magnétique en tirant les deux composants et ôter la partie supérieure de l'éjecteur (G).
4. Séparer l'unité du piston (H) de la partie inférieure de l'éjecteur (I) en dévissant.
5. Retirer le joint torique du piston et le nettoyer.

**Remarque:** Ne pas démonter complètement l'unité du piston (H)!

6. Nettoyer l'unité du piston (H) et la partie inférieure de l'éjecteur (I) à l'aide d'une solution savonneuse ou d'isopropanol puis les rincer à l'eau distillée.
7. Sécher les pièces (120 °C /248 °F maxi) et laisser refroidir.
8. Graisser le joint torique à l'intérieur et à l'extérieur, puis le remonter sur le piston.
9. Remonter l'ensemble des composants dans l'ordre inverse.
10. Puis effectuer la course d'essai (rEF).

**Remarque:** L'ensemble des composants représentés est également disponible comme pièce de rechange (voir page 101 pour les données de commande).

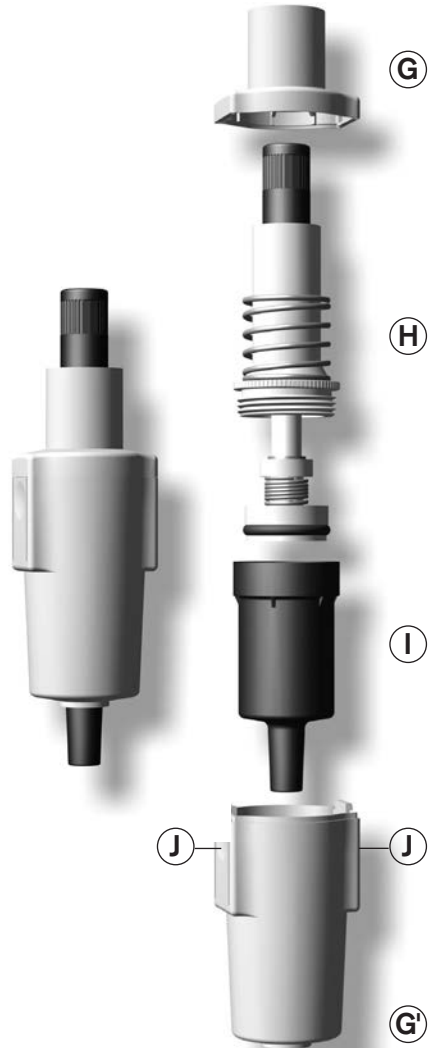



## Recharge et remplacement de la pile

Une pile complètement chargée permet de pipeter en permanence des échantillons à viscosité et densité proches de l'eau durant env. 8 heures (plus de 4000 cycles de pipetage).

### Attention:

Avant de recharger la pile, il est impératif de s'assurer que le bloc d'alimentation convient pour la tension disponible dans le laboratoire. L'appareil ne doit pas être stocké dans les environnements exposés aux explosions. La pile doit uniquement être rechargée dans la Transferpette® electronic!

### Recharge de la pile

- Insérer le connecteur du câble de charge dans la prise prévue à cet effet sur le haut de la Transferpette® electronic. La recharge débute automatiquement.
- Durant la recharge, les barres de l'indicateur de charge de la pile défilent en permanence de haut en bas. La pile est complètement rechargée lorsque les barres de l'affichage ne défilent plus.



### Pipetage durant la recharge?

Durant la recharge, vous pouvez poursuivre votre travail avec la Transferpette® electronic.

Lorsque la pile est complètement déchargée, il faut néanmoins patienter quelques minutes jusqu'à ce que la capacité de charge minimale soit atteinte pour pouvoir garantir une utilisation sûre.

### Remarque:

Les derniers réglages effectués sont mémorisés sur l'EEPROM de l'appareil. Ils sont conservés même en cas de décharge totale ou de remplacement de la pile!

### Remplacement de la pile

- Ouvrir le couvercle du logement de la pile, retirer la pile puis retirer la fiche de la prise.
- Enfoncer la fiche de la pile neuve dans la douille enfichable puis insérer la pile neuve.
- Remettre en place puis refermer le couvercle du logement de la pile.



Durant les pauses, retirer la pile de l'appareil.

## Recharge et remplacement de la pile

### Affichage de la pile après remplacement

- a) Après insertion de la pile, la **capacité maximale** s'affiche **dans un cadre clignotant** (l'appareil ne reconnaît pas immédiatement l'état de charge). Après 3,5 h de charge – charge maximale sûre de la pile – le cadre arrête de clignoter.



#### Remarque:

Après la première mise en place charger pendant 3,5 h. La capacité de charge maximale est atteinte après plusieurs cycles de recharge/décharge.

## Fonction de régénération de la pile

### (fonction Refresh)

Afin de prolonger la durée de vie et d'augmenter le rendement de la pile, la Transferpette® electronic dispose d'une fonction de régénération (fonction Refresh). Cette fonction permet la charge et de la décharge complète de la pile à cycles automatiques. Afin d'optimiser le rendement de la pile, effectuer de temps à autre la fonction Refresh.

### Exécution de la fonction Refresh

- a) Insérer le connecteur (branchement) du bloc d'alimentation dans la douille prévue à cette effect sur le haut de la Transferpette® electronic



- b) Appuyer sur la touche flèche inférieure pendant 3 s minimum. Durant la décharge, les barres d'indication défilent en permanence de haut en bas



- c) Après la décharge (3 h maxi), la procédure de charge démarre automatiquement (3,5 h). Durant la procédure de recharge, les barres d'indication de la charge défilent de haut en bas.







### Interruption de la fonction Refresh

En appuyant sur une touche quelconque, le programme est interrompu. L'appareil commute automatiquement en mode de pipetage par défaut (PIP) et retourne au volume nominal et la procédure de recharge normale débute automatiquement (voir page 97). Le débranchement de la fiche secteur interrompt également le programme. Ne pas interrompre la fonction "Refresh" à la fin du cycle de décharge.

## Dérangement – que faire?

En cas de panne, l'appareil affiche «Err» et le numéro d'erreur sur l'écran. L'appareil ne réagit plus qu'à la touche ENTER. Après avoir actionné la touche ENTER, l'appareil tente de redémarrer. Il demande donc automatiquement une course d'essai (rEF).

Dérangement	Message d'erreur	Cause possible	Que faire?
L'appareil ne réagit pas		Pile vide ou défectueuse	Charger la pile durant 5 min. mini. sans actionner l'appareil puis pour suivre le travail avec le câble de recharge jusqu'à ce que la pile soit rechargée. Le cas échéant, remplacer la pile.
		Composant électronique défectueux	Envoyer l'appareil en réparation.
L'appareil ne réagit pas		Composant électronique défectueux	Envoyer l'appareil en réparation
L'appareil ne réagit pas		Erreur de programme imprévue	Acquittement de l'erreur en actionnant la touche ENTER, l'appareil est réinitialisé.
L'appareil ne réagit pas		Pas de pile dans l'appareil	Insérer une pile
		Pile défectueuse	Remplacer la pile
		Composant électronique défectueux	Envoyer l'appareil en réparation
Pointe goutte/l'appareil n'est pas étanche ou erreur de volume	—	Pointe inadéquate	Employer uniquement des pointes de qualité
		La pointe n'est pas fixée correctement	Enfoncer la pointe plus solidement/autre clip interchangeable
		Piston, tige au joint d'étanchéité en-crassé ou endommagé	Nettoyer l'appareil/remplacer joint d'étanchéité. Graisser le piston.
Aucun affichage sur l'écran		Décharge électrostatique	Enlever l'accumulateur puis le replacer
		Composant électronique défectueux	Envoyer l'appareil en réparation.

## Données de commande · Accessoires · Pièces de rechange

### Transferpette® electronic

Volume	0,5-10 µl	2-20 µl	10-200 µl	50-1000 µl	250-5000 µl
<b>avec bloc d'aliment. (110-240V/50-60 Hz)</b>	Réf.	Réf.	Réf.	Réf.	Réf.
pour Europe (continent.)	7052 99	7053 00	7053 03	7053 06	7053 07
pour UK/Irlande	7053 09	7053 10	7053 13	7053 16	7053 17
pour USA/Japon	7053 19	7053 20	7053 23	7053 26	7053 27
pour Australie	7053 29	7053 30	7053 33	7053 36	7053 37
<b>sans bloc. d'aliment.</b>	7053 39	7053 40	7053 43	7053 46	7053 47

### Blocs d'alimentation (110-240V/50-60 Hz)

	Réf.
pour Europe (continent.)	7053 50
pour UK/Irlande	7053 51
pour USA/Japon	7053 52
pour Australie	7053 53

### Support triple avec bloc d'alimentation pour 3 Transferpette® electronic jusqu'à 1000 µl

avec bloc d'alimentation (110-240V/50-60 Hz)	Réf.
pour Europe (continent.)	7053 90
pour UK/Irlande	7053 91
pour USA/Japon	7053 92
pour Australie	7053 93

### Pile de rechange

pour Transferpette® electronic

Réf.	7055 00
------	---------

### Graisse de silicone

pour Transferpette® electronic jusqu'à 1000 µl

Réf.	7055 02
------	---------

### Graisse de silicone

pour Transferpette® electronic 250 - 5000 µl

Réf.	7036 77
------	---------

### PLT unit

l'appareil de contrôle d'étanchéité de pipette

Réf.	7039 70
------	---------

### Pointes de pipette de qualité de BRAND, non stérilisées, PP

Volume	Unité d'emb.	Réf.
<b>Emballées en vrac</b>		
0,1 - 20 µl	2000	7320 02
0,5 - 20 µl	2000	7320 04
1 - 50 µl	2000	7320 06
2 - 200 µl	1000	7320 08
50 - 1000 µl	1000	7320 12
5 ml	200	7025 95
5 ml	1000	7026 00
<b>5 ml Tip-Box</b>	1 boîte à 28	7026 05

### Filtre pour Transferpette® electronic

5 ml, Emballage standard 25 unités

Réf.	7046 52
------	---------

**Pièces de rechange pour la Transferpette® electronic jusqu'à 1000 µl**

Design et dimensions des pièces de rechange conformément au volume nominal correspondant (illustration pièces de rechange de la Transferpette® electronic 10-200 µl)

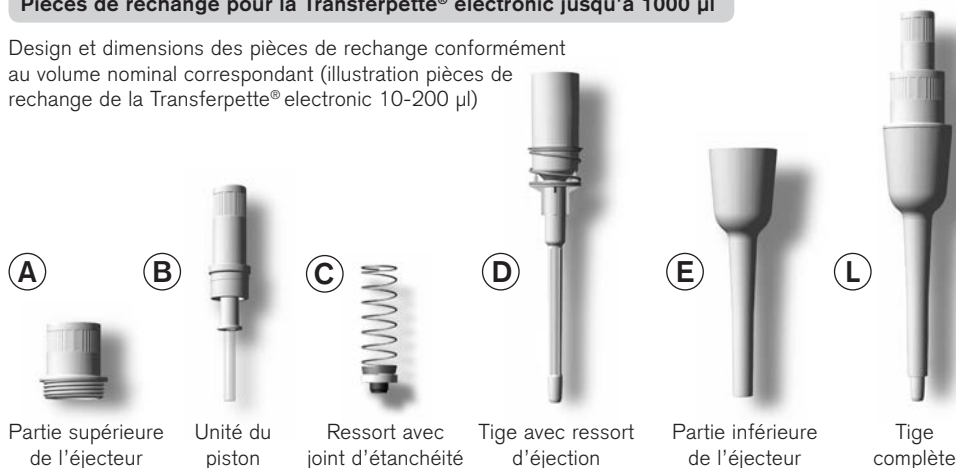

Volume	A	B	C	D	E	L
0,5 - 10 µl	7055 10	7055 18	–	7055 38	7055 48	7055 28
2 - 20 µl	7055 10	7055 20	7055 30	7055 39	7055 50	7055 29
10 - 200 µl	7055 10	7055 22	7055 32	7055 37	7055 53	7055 46
50 - 1000 µl	7055 10	7055 24	7055 34	7055 41	7055 55	7055 47

**Pièces de rechange pour la Transferpette® electronic 250-5000 µl**

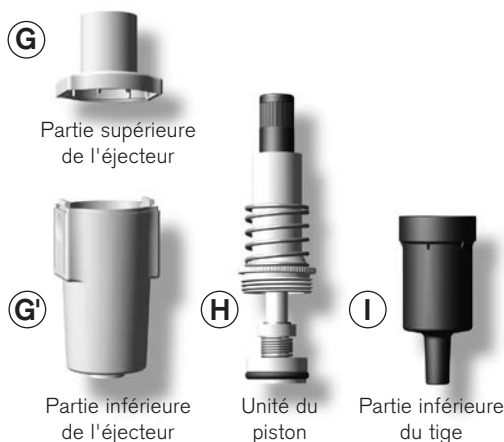

**Accessoires pour la Transferpette® electronic 10-200 µl et 50-1000 µl**

Les clips interchangeables (espateurs) (F) et les tiges de pipettes (K) amovibles avec cône flexible pour le logement de la pointe permettent d'adapter avec une précision optimale la plupart des pointes de pipettes disponibles dans le commerce et d'obtenir des forces d'éjection minimales.



Volume	F	K
10 - 200 µl	7055 60	7055 43
50 - 1000 µl	7055 62	7055 45

Volume	G + G'	H	I
250 - 5000 µl	7299	7055 26	7032 47

### Envoyer en réparation

**Attention:** Transporter des matériaux dangereux sans autorisation est interdit par la loi.

- Nettoyer et décontaminer soigneusement l'appareil.
- Veuillez renvoyer l'appareil, de principe joindre une description précise du type de dysfonctionnement et des fluides utilisés. Si les liquides utilisés ne sont pas indiqués, l'instrument ne peut pas être réparé.
- Tout retour est aux périls et aux frais de l'expéditeur.

### En dehors des États-Unis et de Canada:

- Remplir l'«Attestation de Décontamination» et la retourner avec l'appareil au fabricant ou au fournisseur. Demander le formulaire au fournisseur ou au fabricant ou bien en téléchargement gratuit sous [www.brand.de](http://www.brand.de).

### Aux États-Unis et au Canada:

- Veuillez contacter BrandTech Scientific, Inc. pour demander les conditions de retour de l'appareil **avant** de le renvoyer au service après-vente.
- Veuillez renvoyer seulement les appareils dûment nettoyés et décontaminés, avec le numéro d'autorisation de retour bien en évidence sur l'extérieur de l'emballage, à l'adresse indiquée avec le numéro d'autorisation de retour.

### Adresses de contact

#### BRAND GMBH + CO KG

Otto-Schott-Straße 25  
97877 Wertheim (Germany)  
Tel.: +49 9342 808-0  
Fax: +49 9342 808-98000  
E-Mail: [info@brand.de](mailto:info@brand.de)  
[www.brand.de](http://www.brand.de)

#### États-Unis et Canada:

BrandTech® Scientific, Inc.  
11 Bokum Road  
Essex, CT 06426-1506 (USA)  
Tel.: +1-860-767 2562  
Fax: +1-860-767 2563  
[www.brandtech.com](http://www.brandtech.com)

#### Inde:

BRAND Scientific Equipment Pvt. Ltd.  
303, 3rd Floor, 'C' Wing, Delphi  
Hiranandani Business Park, Powai  
Mumbai - 400 076 (India)  
Tel.: +91 22 42957790  
Fax: +91 22 42957791  
E-Mail: [info@brand.co.in](mailto:info@brand.co.in)  
[www.brand.co.in](http://www.brand.co.in)

#### Chine:

BRAND (Shanghai) Trading Co., Ltd.  
Guangqi Culture Plaza  
Room 506, Building B  
No. 2899, Xietu Road  
Shanghai 200030 (P.R. China)  
Tel.: +86 21 6422 2318  
Fax: +86 21 6422 2268  
E-Mail: [info@brand.cn.com](mailto:info@brand.cn.com)  
[www.brand.cn.com](http://www.brand.cn.com)

### Service de calibration

Les normes ISO 9001 et les directives BPL exigent des contrôles réguliers de vos appareils de volumétrie. Nous recommandons de contrôler les volumes régulièrement tous les 3-12 mois. Les intervalles dépendent des exigences individuelles de l'appareil. Plus l'appareil est utilisé et plus les produits sont agressifs, plus les contrôles doivent être fréquents. Les instructions de contrôle détaillées sont disponibles en téléchargement gratuit sur [www.brand.de](http://www.brand.de) ou [www.brandtech.com](http://www.brandtech.com).

BRAND vous offre également la possibilité de faire calibrer vos instruments par notre service de calibration ou par le laboratoire de calibration DAkkS de BRAND.

Envoyer simplement les appareils à calibrer et indiquer, quelle sorte de calibration vous désirez. Vous recevrez vos appareils avec un rapport de calibration (service de calibration BRAND) resp. avec une attestation de calibration DAkkS. Pour des informations détaillées, veuillez vous renseigner auprès de votre fournisseur ou directement chez BRAND. Le document de commande est disponible pour le téléchargement sur [www.brand.de](http://www.brand.de) (voir 'Documents Techniques').

## Garantie

Nous déclinons toute responsabilité en cas de conséquences d'un traitement, d'une utilisation, d'un entretien et d'une manipulation incorrecte, d'une réparation non-autorisée de l'appareil ou d'une usure normale, notamment des pièces d'usure, telles que les pistons, les joints d'étanchéité, les soupapes et de rupture de pièces en verre. Ceci vaut pour l'inobservation du mode d'emploi. Nous déclinons toute responsabilité en cas de dommages résultant d'actions non décrites dans le mode d'emploi ou si des pièces de rechange ou accessoires qui ne sont pas d'origine, ont été utilisés.

États-Unis et Canada:

Des informations sur la garantie figurent sous [www.brandtech.com](http://www.brandtech.com).

## Elimination

---

Le symbole ci-contre signifie qu'à la fin de leur durée de vie, les piles/accus et appareils électroniques ne doivent pas être éliminés avec les ordures ménagères (déchets municipaux non triés).

- Le traitement special des déchets des appareils électroniques doit être effectué selon les réglementations nationales relatives au traitement des déchets selon la directive 2002/96/CE du Parlement européen et du Conseil du 27 janvier 2003 sur les appareils électriques et électroniques usagés.



- Les piles / accus contiennent des substances susceptibles d'avoir un effet nocif sur l'environnement et la santé. Le traitement special de leurs déchets doit être effectué selon les réglementations nationales relatives au traitement des déchets selon la directive 2006/66/CE du Parlement européen et du Conseil du 6 septembre 2006 sur les piles / accus usagés. N'éliminer la pile / accu que quand il est déchargé complètement.

### **Avertissement!**

Ne pas court-circuiter les piles / accus pour les décharger!

Sous réserve de modifications techniques, d'erreurs ou errata.



	Página
Normas de seguridad	106
Función y limitaciones de empleo	107
Excepciones de uso	107
Elementos de manejo	108
<b>Los primeros pasos</b>	<b>109</b>
Ajuste de volumen	110
Ajuste de la velocidad de aspiración y salida	111
Pipetear correctamente	112
Programas de pipeteado	113
<b>Modo PIP</b>	<b>114</b>
<b>Modo PIPmix</b>	<b>116</b>
<b>Modo revPIP</b>	<b>118</b>
<b>Modo de electroforesis (GEL)</b>	<b>120</b>
<b>Modo DISP</b>	<b>122</b>
Controlar el volumen	124
Tabla de precisión	125
<b>Easy Calibration (Ajustar)</b>	<b>126</b>
Autoclavage	128
Recorrido de referencia (rEF)	128
Mantenimiento y limpieza	129
Cargar y cambiar la batería	131
Función de regeneración de batería	132
¿Qué hacer en caso de avería?	133
Referencias · Accesorios · Recambios	134
Reparación · Direcciones de contacto	136
Servicio de calibración	137
Garantía · Eliminación	138

## Normas de seguridad

Este aparato puede entrar en contacto con instalaciones, aplicaciones o materiales peligrosos. Estas instrucciones de manejo no tienen por objeto enumerar todas las limitaciones de seguridad que pueden presentarse durante el uso. El usuario del aparato tiene responsabilidad de tomar las medidas suficientes para su seguridad y su salud, así como determinar las limitaciones de uso correspondientes antes de su utilización.



### Rogamos lea este documento cuidadosamente

1. Todo usuario debe haber leído estas instrucciones de manejo antes de utilizar el aparato, y debe seguirlos.
2. Observar las advertencias de peligro y las reglas de seguridad generales, como por ejemplo utilizar vestimenta, protección de los ojos y guantes de protección.  
Al trabajar con muestras infecciosas o peligrosas, deberán seguirse las normativas estándar de laboratorios y tomar las medidas pertinentes.
3. Observar las indicaciones del fabricante de los reactivos.
4. No hacer funcionar el aparato en atmósfera con peligro de explosión. No se deben pipetear medios fácilmente inflamables.
5. El aparato deberá utilizarse exclusivamente para pipetear líquidos cumpliendo siempre con los limitaciones de empleo y excepciones de uso (véase pág. 107). En caso de duda, dirigirse sin falta al fabricante o al distribuidor.
6. Trabajar siempre de tal manera que no corran peligro ni el operador ni otras personas. Evitar salpicaduras. Utilice solamente recipientes adecuados.
7. Al trabajar con medios agresivos, evitar el contacto con la abertura de las puntas.
8. No emplear nunca la fuerza.
9. Utilizar sólo recambios originales. No efectúe ninguna modificación técnica. ¡No desmonte el aparato más allá de lo descrito en las instrucciones de manejo!
10. Antes de cada uso, comprobar el estado correcto de aparato. En el caso de que se produzcan averías en el aparato (por ej. desplazamiento difícil del émbolo, válvulas adheridas, falta de hermeticidad), inmediatamente dejar de valorar, limpiar y seguir las instrucciones del capítulo '¿Qué hacer en caso de avería?' (véase pág. 133). En caso necesario dirigirse al fabricante.
11. No reemplazar el acumulador original por acumuladores no recargables o recargables de otros fabricantes.
12. Para cargar las baterías de níquel-metal hidruro, utilizar exclusivamente el equipo de red original.
13. Se debe utilizar el equipo de red únicamente con este aparato y protegerlo contra humedad.
14. Eliminar el acumulador sólo cuando está completamente descargado, y de acuerdo a las prescripciones en vigor.

### Advertencia:

La manipulación inadecuada del aparato o las baterías (cortocircuito, destrucción mecánica, sobrecalentamiento, un bloque de alimentación inadecuado, etc.) puede causar la explosión de las baterías en el caso más desfavorable.

Transferpette® electronic es una pipeta de embolo controlada por microprocesador y que funciona con batería siguiendo el principio de cojín de aire para pipetear soluciones acuosas de viscosidad y densidad medias.

Si el aparato se maneja correctamente, la muestra que se desea dosificar sólo tendrá contacto con la punta, y no con Transferpette® electronic.

### Limitaciones de empleo

El aparato sirve para pipetear muestras teniendo en consideración las siguientes limitaciones:

- Temperatura de empleo de +15 °C a +40 °C (de 59 °F a 104 °F) (de aparato y reactivos: pueden obtenerse otras temperaturas si así se desea)
- Presión de vapor de hasta 500 mbar
- Viscosidad: 260 mPa s

### Limitaciones de uso

Los líquidos viscosos y humectantes pueden afectar a la exactitud del volumen. Al igual que los líquidos cuya temperatura difiera en más de  $\pm 5$  °C/ 41 °F de la temperatura ambiente.

### Excepciones de uso

El usuario debe asegurarse de la compatibilidad del aparato para cada aplicación.

Nunca utilice el aparato para pipetear líquidos que puedan corroer polipropileno (vástago y puntas), policarbonato/polibutilenotereftalato (carcasa) o EPDM (vástagos de pipeta de recambio flexibles). Evite los vapores agresivos (peligro de corrosión). La empuñadura no es autoclavable.

### Especificaciones de la batería y del equipo de red

#### Batería

Batería de níquel-metalhidruro con 3 pilas individuales cilíndricas del tamaño AAA, 3,6 V, 700 mAh

#### Equipo de red

Tensión de salida de 6,5 V CC, 200 mA

## Elementos de manejo

Transferpette® electronic es una pipeta de embolo aspirante controlada por microprocesador y que funciona con batería que ha sido optimizada en cuanto a su ergonomía y facilitación de manejo.



### El campo de teclas

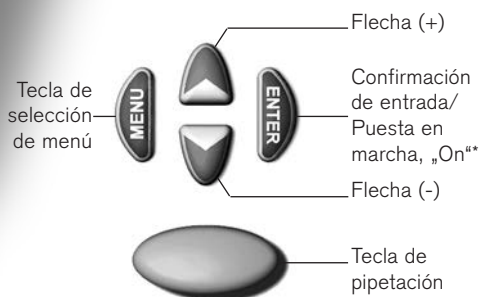

\*) El instrumento se activa pulsando la tecla Enter. Tras pulsar la tecla de pipeteado el instrumento está listo para pipetear.

Transferpette® electronic se apaga automáticamente al haber pasado 10 minutos desde el último uso (Auto-Power-Off).

## ¿La caja viene completa?

En la caja, deberá encontrar su Transferpette® electronic, una batería, el equipo de red con cable de carga de batería, aceite de silicona, las presentes instrucciones de manejo, así como 1 paquete de muestra con puntas de pipetas.

### Puesta en marcha de Transferpette® electronic

#### 1. Colocar la batería

- a) Abra la tapa del compartimento de la batería.
- b) Inserte la batería. Tenga en cuenta que la clavija de la misma quede bien encajado en la hembra del aparato.
- c) Vuelva a colocar la tapa del compartimento de la batería y ciérrela bien.



#### 2. Activar el aparato

Transferpette® electronic solicita automáticamente un recorrido de referencia en cuanto se coloca la batería. Tras pulsar la tecla de pipeteado, se ejecuta el recorrido de referencia y el aparato estará listo para pipetear.



1x

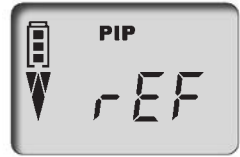

La pantalla muestra el modo de pipeteado estándar (PIP) ajustado en fábrica y el volumen nominal correspondiente (aquí, por ejemplo, 200,0 µl). La velocidad de aspiración y salida han sido ajustadas de fábrica con el valor máximo. El ajuste sencillo de volumen y velocidad se describe en las páginas siguientes.

Modo de pipeteado

Indicación de capacidad de la batería

Símbolo de flecha para 'Aspirar'

Indicación del volumen



# Ajuste de volumen

El volumen viene ajustado de fabrica al volumen nominal de Transferpette® electronic y puede modificarse individualmente de forma rápida y sencilla.

¿Qué tengo que hacer? ¿Cómo se hace?

¿Qué tecla?

¿Qué indica la pantalla?

## 1. Activar la selección de volumen

Pulsando una de las flechas, podrá seleccionar el volumen directamente. 'VOL' se encenderá intermitentemente.



## 2. Ajuste de volumen

### Reducir

Pulsando la flecha (-) se reduce el volumen. Si mantiene pulsada la flecha, modificará el volumen con mayor rapidez. 'VOL' continuará encendiéndose intermitentemente.

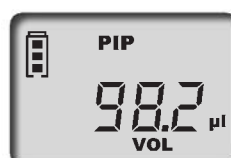

### Aumentar

Pulsando la flecha (+) se aumenta el volumen. Si mantiene pulsada la flecha, modificará el volumen con mayor rapidez. 'VOL' continuará encendiéndose intermitentemente.

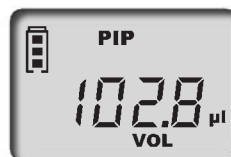

## 3. Confirmar la selección de volumen

Pulsar la tecla Enter. Entonces, la pantalla mostrará el nuevo volumen ajustado. Como ejemplo, aquí le mostramos la pantalla del modo PIP ajustado como en serie.

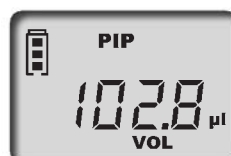

### Importante:

Pulsando la tecla de menú, podrá cancelar todos los procesos de ajuste. Entonces, la pantalla pasará a la opción de ajuste más cercana o volverá a la indicación inicial.

## Ajuste de la velocidad de aspiración y salida

Las velocidades de aspiración y salida pueden ajustarse de forma individual. Al llamar el menú, se mostrará la última velocidad ajustada correspondientemente. Existen 5 niveles de velocidad ajustables correspondientemente.

¿Qué tengo que hacer? ¿Cómo se hace?

¿Qué tecla?

¿Qué indica la pantalla?

### Ajustar la velocidad de aspiración

#### 1. Llamar el menú

Pulsando una vez y brevemente la tecla de menú, se llega al menú de velocidad de aspiración. La palabra **,Speed'** se iluminará intermitentemente.

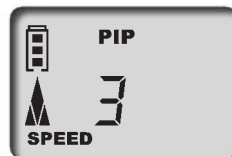

#### 2. Ajustar la velocidad de aspiración

Pulsando las flechas (+/-) se selecciona el nivel de velocidad (por ejemplo, nivel 5). La palabra **,Speed'** continuará iluminándose intermitentemente.

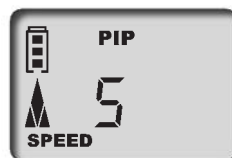

#### 3. Confirmar el nivel de velocidad

Pulsar la tecla Enter. La pantalla vuelve al estado básico del modo ajustado; aquí, como ejemplo, la pantalla del modo PIP estándar.



### Ajustar la velocidad de salida

#### 1. Llamar el menú

Pulsando dos veces y brevemente la tecla de menú, se llega al menú de velocidad de salida. La palabra **,Speed'** se iluminará intermitentemente.

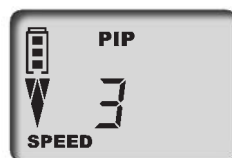

#### 2. Ajustar la velocidad de salida

Pulsando las flechas (+/-) se selecciona el nivel de velocidad (por ejemplo, nivel 2). La palabra **,Speed'** continuará iluminándose intermitentemente.

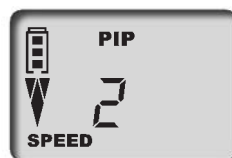

#### 3. Confirmar el nivel de velocidad

Pulsar la tecla Enter. Entonces, la pantalla vuelve al estado básico del modo ajustado; aquí, como ejemplo, la pantalla del modo PIP estándar.



El volumen viene ajustado de fábrica al volumen nominal de Transferpette® electronic y puede modificarse individualmente de forma rápida y sencilla (véase la página 110).

## Inicio rápido (Quick Start) en el modo de pipeteado estándar

### 1. Acoplar la punta

Utilizar la punta apropiada, de acuerdo con el rango de volumen y el código de color. Verificar que el asiento de la punta sea hermético y esté bien firme. En caso de uso del vástago de pipeta flexible si es necesario usar pinza de cambio alternativa. Puntas de pipeta son artículos desechables!

### 2. Aspirar líquido



Mantenga el aparato en posición vertical y sumerja la punta 2-3 mm en el líquido.

Pulsando la tecla de pipeteado, el líquido se aspirará. La flecha de la pantalla indica hacia arriba (aspiración).



**Nota:** Para que no se aspire aire, mantenga sumergida la punta durante aprox. 1 seg. más.

### 3. Expulsar líquido

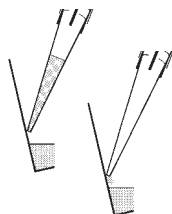

Una vez finalizada la absorción de líquido, la flecha de la pantalla indicará hacia abajo (salida).

Apoye la punta de la pipeta en la pared del recipiente. Mantenga la pipeta en un ángulo de 30-45°.

Pulsando nuevamente la tecla de pipeteado, el líquido se soltará completamente con la carrera excesiva automática. Al hacerlo, escurra la punta de la pipeta en la pared del recipiente.



### 4. Expulsar la punta



Mantenga el vástago de pipetas sobre un recipiente de residuos adecuado y pulse hacia abajo la tecla de eyección de la punta.

Tecla de eyección de la punta



**Nota:**

La norma ISO 8655 prescribe que la punta, antes del proceso de pipeteado propiamente dicho, debe enjuagarse con el líquido de la muestra.



- 1. Pipeteado normal**  
Modo **PIP** \_\_\_\_\_ **114**  
Programa estándar.  
Se aspira un volumen ajustado previamente  
y se vuelve a soltar.
  
- 2. Mezclar muestras**  
Modo **PIPmix** \_\_\_\_\_ **116**  
Programa para mezclar líquidos. La muestra  
se aspira y suelta repetidamente en todo  
momento.
  
- 3. Pipeteado inverso**  
Modo **revPIP** \_\_\_\_\_ **118**  
Programa especial para pipetear líquidos  
de alta viscosidad, alta presión de vapor  
o medios espumosos.
  
- 4. Pipetear en electroforesis**  
Modo **GEL** \_\_\_\_\_ **120**  
Programa para cargar geles en electroforesis.  
Un volumen de muestra previamente definido  
se aspira a gran velocidad modificable y se  
vuelve a soltar lentamente.
  
- 5. Dosificación**  
Modo **DISP** \_\_\_\_\_ **122**  
Programa para la dosificación de líquidos.  
Un volumen aspirado es dosificado en pasos  
parciales.

Transferpette® electronic de 1000 µl y 5000 µl  
no dispone del modo GEL.

El programa estándar:

se aspira un volumen ajustado previamente y se vuelve a soltar.

El ajuste de volumen y velocidad como se ha descrito en la página 110/111.

¿Qué tengo que hacer? ¿Cómo se hace?

¿Qué tecla?

¿Qué indica la pantalla?

## 1. Llamar la selección de menú

Pulsando la tecla de menú tres veces, se llega a la selección de programa. 'Mode' se iluminará intermitentemente.

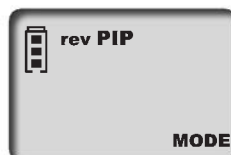

## 2. Ajustar el modo PIP

Con una de las flechas, desplácese por los diferentes modos hasta que aparezca 'PIP'. 'Mode' continuará iluminándose intermitentemente.

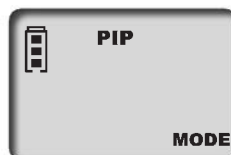

## 3. Confirmar el modo PIP

Pulsar la tecla Enter. En la pantalla, podrá leer 'blo', que equivale a blow-out (carrera excesiva).

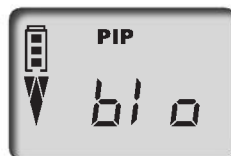

## 4. Preparación para pipetear

Pulsando la tecla de pipetación una vez, el émbolo se colocará en la posición de salida. La flecha de la pantalla indicará hacia arriba (aspiración).



## 5. Absorber el líquido

Para aspirar el líquido, pulse una vez la tecla de pipeteado.

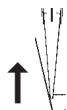

¿Qué tengo que hacer? ¿Cómo se hace?

¿Qué tecla?

¿Qué indica la pantalla?

## 6. Soltar líquido

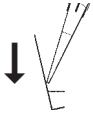

Pulsando una vez la tecla de pipeteado, se provocará la expulsión del líquido. La flecha de la pantalla indicará hacia abajo (salida).



## 7. ¿Activar la carrera excesiva?

**¡Usted no tiene que hacer nada!** Al pipetear en el modo PIP, **¡la carrera excesiva (blow-out) se activa automáticamente!**



## Activación directa del blow-out

La carrera excesiva (blow-out) también puede activarse directamente en todo momento, siempre que sea necesario.

### 1. Llamar la función blow-out

Pulsar la tecla Enter. En la pantalla, podrá leer 'blo', que equivale a blow-out.

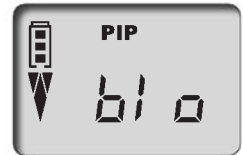

### 2. Activar la carrera excesiva

Pulsando una vez la tecla de pipeteado, se activa la carrera excesiva y la pantalla vuelve a mostrar el modo de pipeteado ajustado (posición de salida).

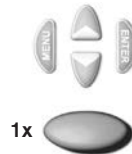

### Nota:

En el modo de carrera excesiva (blow-out), el émbolo se mueve completamente hacia abajo. Deberá asegurarse de que el posible líquido sobrante se suelte sin provocar peligros.

**Mantener la tecla de pipeteado apretada mantiene el émbolo abajo, por lo que evita que se produzca una aspiración no deseada de líquido. Soltarla provocará que el émbolo vuelva a la posición de salida.**

Programa para mezclar líquidos.

La muestra se aspira y suelta repetidamente en todo momento.

El ajuste de volumen y velocidad como se ha descrito en la página 110/111.

¿Qué tengo que hacer? ¿Cómo se hace? ¿Qué tecla? ¿Qué indica la pantalla?

## 1. Llamar la selección de menú

Pulsando la tecla de menú tres veces, se llega a la selección de programa. 'Mode' se iluminará intermitentemente.



## 2. Ajustar el modo PIPmix

Con una de las flechas, desplácese por los diferentes modos hasta que aparezca 'PIPmix'. 'Mode' continuará iluminándose intermitentemente.



## 3. Confirmar el modo PIPmix

Pulsar la tecla Enter. En la pantalla, podrá leer 'blo', que equivale a blow-out (carrera excesiva).



## 4. Preparación para pipetear

Pulsando la tecla de pipeteado una vez, el émbolo se colocará en la posición de salida. La flecha de la pantalla indicará hacia arriba (aspiración).



## 5. Aspirar el líquido

Para aspirar el líquido, pulse una vez la tecla de pipeteado.

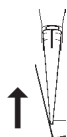

¿Qué tengo que hacer? ¿Cómo se hace?

¿Qué tecla?

¿Qué indica la pantalla?

**6. Soltar líquido en el modo PIPmix**

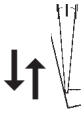

Manteniendo pulsada la tecla de pipeteado, se provocará la salida y aspiración alterna del líquido. En la pantalla aparecerán alternados los iconos de las flechas de absorción o salida, así como el número de ciclos.



**7. Finalizar el pipeteado**













Pulsando una vez la tecla de pipeteado, se suelta el líquido y se activa la carrera excesiva (el blow-out).

Una vez soltado el líquido restante (carrera excesiva), la pantalla volverá a ponerse en el modo ajustado (posición de salida).



**Nota:** La pantalla muestra un máximo de 19 ciclos.

Programa especial para pipetear líquidos de alta viscosidad, presión de vapor o medios espumosos. El ajuste de volumen y velocidad, véase la descripción de la página 110/111.

¿Qué tengo que hacer?	¿Cómo se hace?	¿Qué tecla?	¿Qué indica la pantalla?
<b>1. Llamar la selección de menú</b>	Pulsando la tecla de menú tres veces, se llega a la selección de programa. 'Mode' se iluminará intermitentemente.	3x 	
<b>2. Ajustar el modo revPIP</b>	Con una de las flechas, desplácese por los diferentes modos hasta que aparezca 'revPIP'. 'Mode' continuará iluminándose intermitentemente.		
<b>3. Confirmar el modo revPIP</b>	Pulsar la tecla Enter. En la pantalla, podrá leer 'blo', que equivale a blow-out (carrera excesiva).	 1x	
<b>4. Preparación para pipetear</b>	Pulsando la tecla de pipeteado una vez, el émbolo se colocará en la posición de salida. La flecha de la pantalla indicará hacia arriba (aspiración).	 1x	
<b>5. Absorber el líquido</b>	Pulsar la tecla de pipeteado una vez: ¡se aspirará un volumen algo superior al ajustado!	 1x	
<b>6. Soltar líquido en el modo revPIP</b>	Para soltar líquido, pulse la tecla de pipeteado una vez. La pantalla mostrará la flecha hacia abajo (salida). Entonces, se soltará el volumen ajustado y quedará algo de líquido en la punta.	 1x	

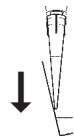
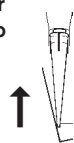

¿Qué tengo que hacer? ¿Cómo se hace?

¿Qué tecla?

¿Qué indica la pantalla?

**7. Volver a aspirar líquido en el modo revPIP**

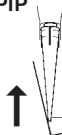

Pulsando nuevamente la tecla de pipeteado, se volverá a aspirar el volumen ajustado. (Pulsando nuevamente la tecla de pipeteado, se vuelve a soltar el volumen, etc.)



**8. Activar la carrera excesiva**

Tras el último pipeteado, pulsar la tecla Enter. En la pantalla, podrá leer 'blo', que equivale a blow-out (carrera excesiva).

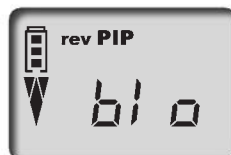

Pulsando una vez la tecla de pipeteado, se activa la carrera excesiva (el blow-out) y se suelta el líquido restante.











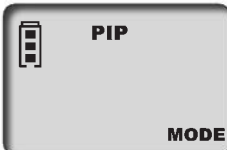

**9. Finalizar el pipeteado**

Una vez soltado el líquido restante (carrera excesiva), la pantalla volverá a ponerse en el modo ajustado (posición de salida).

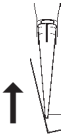

Programa para cargar geles en electroforesis. Un volumen de muestra previamente definido se absorbe a gran velocidad modificable y se vuelve a soltar lentamente. El ajuste de volumen y velocidad como se ha descrito en la página 110/111.

¿Qué tengo que hacer? ¿Cómo se hace?	¿Qué tecla?	¿Qué indica la pantalla?
<p><b>1. Llamar la selección de menú</b></p>	<p>Pulsando la tecla de menú tres veces, se llega a la selección de programa. 'Mode' se iluminará intermitentemente.</p>	<p>3x  </p>
<p><b>2. Ajustar el modo GEL</b></p>	<p>Con una de las flechas, desplácese por los diferentes modos hasta que aparezca 'GEL'. 'Mode' continuará iluminándose intermitentemente.</p>	<p> </p>
<p><b>3. Confirmar el modo GEL</b></p>	<p>Pulsar la tecla Enter. En la pantalla, podrá leer 'blo', que equivale a blow-out (carrera excesiva).</p>	<p> 1x </p>
<p><b>4. Preparación para pipetear</b></p>	<p>Pulsando la tecla de pipeteado una vez, el émbolo se colocará en la posición de salida. La flecha de la pantalla indicará hacia arriba (aspiración).</p>	<p> 1x </p>
<p><b>5. Aspirar líquido</b></p> 	<p>Para aspirar el líquido, pulse una vez la tecla de pipeteado. El volumen ajustado se aspira.</p> <p><b>Aspirar un mayor volumen</b></p>	<p> 1x </p>
	<p>Para aspirar más líquido que el ajustado (hasta un máximo del 110% del volumen nominal), mantenga la tecla de pipeteado durante el proceso de aspiración hasta que se haya aspirado el volumen deseado. En la pantalla, aparecerá un rombo.</p>	<p> <b>mantener pulsada</b> </p>



¿Qué tengo que hacer? ¿Cómo se hace?      ¿Qué tecla?      ¿Qué indica la pantalla?

## 6. Soltar líquido en el modo GEL

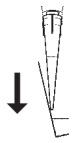

Para soltar líquido, pulse brevemente la tecla de pipeteado una vez. En la pantalla, aparecerá un rombo. El volumen aspirado se irá soltando lentamente.

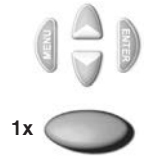

### Detener la salida

La salida de muestra puede detenerse pulsando nuevamente la tecla de pipeteado. La pantalla mostrará el volumen de la cantidad de líquido soltada.

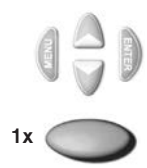

## 7. Activar la carrera excesiva

Tras el último pipeteado, pulsar la tecla Enter. En la pantalla, podrá leer 'blo', que equivale a blow-out (carrera excesiva).



Pulsando una vez la tecla de pipeteado, se activa la carrera excesiva (el blow-out) y se suelta el líquido restante.

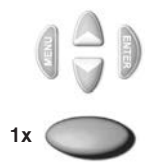

## 8. Finalizar el pipeteado









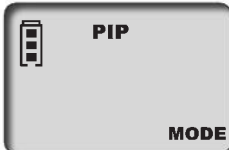

Una vez soltado el líquido restante (carrera excesiva), la pantalla volverá a ponerse en el modo ajustado (posición de salida).



### Nota:

El modo GEL exige velocidades de salida muy lentas para evitar que se produzcan fluidizaciones en las muestras. Para que quede garantizada la salida óptima, la velocidad de salida viene fijada de fábrica. Es claramente más lenta que el nivel 1 ajustable, y no puede ser seleccionada individualmente.

Programa para la dosificación de líquidos. Un volumen aspirado es dosificado en pasos parciales. Se aspira un poco más volumen que calculadamente necesario. El ajuste de la velocidad como se ha descrito en la página 111.

¿Qué tengo que hacer? ¿Cómo se hace?	¿Qué tecla?	¿Qué indica la pantalla?
<p><b>1. Llamar la selección de menú</b></p>	<p>Pulsando la tecla de menú tres veces, se llega a la selección de programa. 'Mode' se iluminará intermitentemente.</p>	<p>3x  </p>
<p><b>2. Ajustar el modo DISP</b></p>	<p>Con una de las flechas, desplácese por los diferentes modos hasta que aparezca 'DISP'. 'Mode' continuará iluminándose intermitentemente.</p>	<p> </p>
<p><b>3. Confirmar el modo DISP</b></p>	<p>Pulsar la tecla Enter. En la pantalla, podrá leer 'blo', que equivale a blow-out (carrera excesiva).</p>	<p> 1x </p>
<p><b>4. Preparación para dosificar</b></p>	<p>Pulsando la tecla de pipeteado una vez, el émbolo se colocará en la posición de salida. La flecha de la pantalla indicará hacia arriba (absorción).</p>	<p> 1x </p>
<p><b>5. Ajustar el volumen parcial</b></p>	<p>Pulsando la flecha (+/-) se ajustará el volumen. Si mantiene pulsada la flecha, modificará el volumen con mayor rapidez. 'VOL' se iluminará intermitentemente.</p>	<p> </p>
<p><b>6. Confirmar el volumen parcial</b></p>	<p>Pulsar la tecla Enter. La pantalla mostrará el nuevo volumen parcial ajustado. 'steps' se iluminará intermitentemente. El display enseña el número máximo posible de pasos.</p>	<p> 1x </p>

¿Qué tengo que hacer? ¿Cómo se hace?

¿Qué tecla?

¿Qué indica la pantalla?

**7. Ajustar el número de pasos**

Pulsando la flecha (+/-) se ajusta el número de pasos. 'steps' continuará encendiéndose intermitentemente.

**8. Confirmar el número de pasos**

Pulsar la tecla Enter. Entonces, la pantalla mostrará el número de pasos seleccionado.

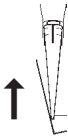
**9. Absorber el líquido**

Para absorber el líquido, pulse una vez la tecla de pipeteado.

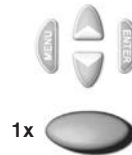
**10. Soltar el líquido**

Con cada pulsación de la tecla de pipeteado se efectúa un paso de dosificación. La flecha de la pantalla indicará hacia abajo (salida). La pantalla mostrará el número de pasos restantes.

**11. Activar la carrera excesiva**

Tras la última dosificación pulsar la tecla Enter. En la pantalla, podrá leer 'blo', (carrera excesiva). Pulsando de la tecla pipeteado tras activará la carrera excesiva (blow-out) (véase pág 121).

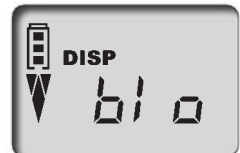
**12. Finalizar la dosificación**

Una vez soltado el líquido restante (carrera excesiva), la pantalla volverá a ponerse en el modo ajustado (posición de salida).



# Controlar el volumen

Recomendamos, dependiendo del uso, que el aparato pase por un control cada 3-12 meses. No obstante, el ciclo puede adaptarse a sus necesidades individuales.

La comprobación de volumen gravimétrica de la pipeta se realiza en pasos subsiguientes y cumple con la norma DIN EN ISO 8655, parte 6.

## 1. Ajustar el volumen nominal

Ajuste el volumen al máximo volumen indicado en el instrumento. Para informarse sobre el modo de proceder, véase la página 110.

## 2. Condicionar la pipeta

Condicionar la pipeta antes de realizar la comprobación, aspirando y sacando el líquido de comprobación (H<sub>2</sub>O dest.) cinco veces con una punta de pipetear. Después, desechar la punta de pipetear.

## 3. Realizar la comprobación

- Acople la nueva punta de pipetear y enjuague una vez con el líquido de comprobación.
- Aspire el líquido de comprobación y pipetéelo en el recipiente de pesar.
- Pese la cantidad pipeteada con una balanza de análisis. (Siga las instrucciones de manejo del fabricante de la balanza).
- Calcule el volumen pipeteado. A la hora de hacerlo, tenga en cuenta la temperatura.
- Se recomienda hacer al menos 10 pipeteados y pesarlos en 3 márgenes de volumen (100%, 50%, 10%).

### Cálculo (para el volumen nominal)

$x_i$  = resultados de las pesadas  
 $n$  = número de pesadas

$Z$  = factor de corrección  
(por ej. 1,0029 µl/mg a una temperatura de 20 °C, 1013 hPa)

Valor medio  $\bar{x} = \frac{\sum x_i}{n}$

Volumen medio  $\bar{V} = \bar{x} \cdot Z$

#### Exactitud\*

$$E\% = \frac{\bar{V} - V_0}{V_0} \cdot 100$$

$V_0$  = volumen nominal

#### Desviación standard

$$s = Z \cdot \sqrt{\frac{\sum (x_i - \bar{x})^2}{n - 1}}$$

#### Coefficiente de variación\*

$$CV\% = \frac{100 \cdot s}{\bar{V}}$$

\*) = Cálculo de la exactitud (E%) y el coeficiente de variación (CV%):

E% y CV% se calculan según las fórmulas de control estadístico de calidad.

## Tabla de precisión

Los valores finales de comprobación referentes al volumen nominal impreso en el aparato (= vol. máximo) y a los volúmenes parciales indicados a la misma temperatura (20 °C/68 °F) del aparato, entorno y agua dest. según la norma DIN EN ISO 8655.



### Valores de precisión de Transferpette® electronic

Gama de ajuste µl	Volumen parcial µl	E* ≤ ± %	CV* ≤ %	Pasos parciales µl	Tipo de punta rec., µl
0,5 - 10	10	1,0	0,4	0,01	0,5 - 20
	5	1,5	0,8		
	1	5,0	2,0		
2 - 20	20	1,0	0,4	0,02	0,5 - 20
	10	1,5	0,8		
	2	5,0	2,5		
10 - 200	200	0,8	0,2	0,2	2 - 200
	100	1,2	0,3		
	20	4,0	0,6		
50 - 1000	1000	0,6	0,2	1,0	50 - 1000
	500	1,0	0,3		
	100	3,0	0,6		
250 - 5000	5000	0,6	0,2	5,0	500 - 5000
	2500	1,0	0,3		
	500	3,0	0,6		

\* E = Exactitud, CV = Coeficiente de variación

#### Nota:

El equipo está identificado de acuerdo con la Ley de Medición y Calibración de Alemania y el Reglamento de Medición y Calibración:

**DE-M 19**

La secuencia de caracteres DE-M («DE» en referencia a Alemania) enmarcada en un rectángulo, así como las últimas dos cifras del año en el que se realizó la identificación (en este caso, 2019).

#### Nota:

Bajo [www.brand.de](http://www.brand.de) se encuentran instrucciones de ensayo disponibles, como así también una versión del programa de calibración EASYCAL™ 4.0.

## El modo de ajuste 'CAL'

### Ajustar

El volumen nominal o el volumen que debe comprobarse está ajustado, modo estándar de pipetear (PIP), por ejemplo 200,0 µl (Modo de proceder, véase la página 110, 114). P.e.: volumen correspondiente de la comprobación de volumen 201,3 µl.



¿Qué tengo que hacer?    ¿Cómo se hace?    ¿Qué tecla?    ¿Qué indica la pantalla?

### 1. Llamar el modo CAL

Manteniendo pulsada (>3 seg.) la tecla de menú, se llama el modo CAL. En la pantalla, aparecerá 'off'. 'CAL' se iluminará intermitentemente.



### 2. Activar el modo CAL

Pulsando una de las flechas, se activa el modo CAL. En la pantalla, se pasará de 'off' a 'on'. 'CAL' continuará encendiéndose intermitentemente.

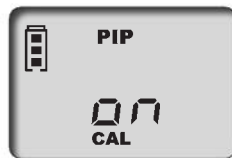

### 3. Confirmar el modo CAL

Pulsar la tecla Enter. En la pantalla podrá volver a leer el volumen de pipeteado ajustado. 'CAL' se iluminará intermitentemente.



### 4. Ajuste de volumen

Con las flechas (+/-), ajuste el volumen determinado y comprobado anteriormente. 'CAL' se iluminará intermitentemente.



### 5. Confirmar el volumen

Pulsar la tecla Enter. En la pantalla aparecerá el volumen comprobado y corregido. El símbolo CAL que entonces aparecerá constantemente es prueba del ajuste realizado.



## Volver a obtener el estado original de fábrica

El símbolo CAL que aparece constantemente en la pantalla es muestra de que se ha realizado un ajuste.



¿Qué tengo que hacer? ¿Cómo se hace?

¿Qué tecla?

¿Qué indica la pantalla?

### 1. Llamar el modo CAL

Manteniendo pulsada (>3 seg.) la tecla de menú, se llama el modo CAL. En la pantalla, aparecerá 'on'. 'CAL' se iluminará intermitentemente.

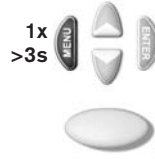

### 2. Desactivar el modo CAL

Pulsando una de las flechas, se desactiva el modo CAL. En la pantalla, se pasará de 'on' a 'off'. 'CAL' continuará encendiéndose intermitentemente.

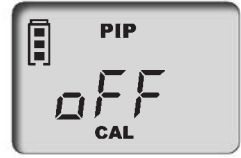

### 3. Volver a activar el estado original de fábrica

Pulsar la tecla Enter. El icono CAL que aparecía constantemente ha desaparecido. El aparato vuelve a estar en el estado original de fábrica.



## Importante:

En Transferpette® electronic, al realizar un ajuste se realiza un offset del volumen, es decir, el volumen se modifica en todo el margen de volumen de la pipeta con la misma cantidad. Se recomienda realizar el ajuste a un 50% del volumen nominal.

## Nota:

El aparato está ajustado permanentemente para soluciones acuosas, aunque también puede ajustarse para soluciones de diversos espesores, diversas viscosidades y diversas temperaturas. Transferpette® electronic puede ser ajustado en todos los modos (excepto el modo GEL).

## Autoclavage

El vástago de pipeta ilustrado de Transferpette® electronic es autoclavable a 121 °C (250 °F), 2 bares y con un tiempo de exposición de como mínimo 15 minutos según DIN EN 285.

**Atención:** ¡La empuñadura no es autoclavable!

1. Eyectar la punta de la pipeta.
2. Destornillar el vástago de la empuñadura.
3. Sin desmontarlo adicionalmente, autoclavar el vástago de pipeta completo.
4. Dejar que el vástago de pipeta se enfríe y seque completamente.
5. Atornillar otra vez el vástago en la empuñadura.
6. Realizar el recorrido de referencia (rEF).

**Nota:** La eficacia de la autoclavación deberá ser comprobada por el propio usuario. La esterilización al vacío proporciona la máxima seguridad. Recomendamos el uso de bolsas de esterilización.

En caso de que se autoclave el vástago de la pipeta con frecuencia, el émbolo y la junta deberá engrasarse con grasa de silicona adjunto para mejorar el paso.

## Recorrido de referencia (rEF)

Cada vez que sustituya el vástago de la pipeta deberá realizar un recorrido de referencia manual. El recorrido de referencia sirve para acoplar el émbolo de forma segura.



¿Qué tengo que hacer? ¿Cómo se hace?

¿Qué tecla?

¿Qué indica la pantalla?

1. Llamar el modo rEF

Apretando simultáneamente las teclas de menú y Enter se activa el modo rEF.

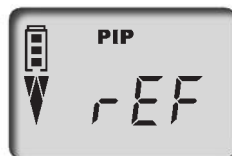

2. Ejecutar el recorrido de referencia

Apretando una vez la tecla de pipetación se inicia el recorrido de referencia. Podrá escuchar un sonido claro debido al funcionamiento.



**Nota:** Una vez realizado el recorrido de referencia, la pantalla vuelve a pasar automáticamente al programa que estaba ajustado anteriormente.



Para garantizar el funcionamiento correcto de Transferpette® electronic, deberán realizarse trabajos de mantenimiento y limpieza regularmente.

### Mantenimiento

Compruebe que el cono de acoplamiento de puntas de pipetas no está dañado.

Compruebe también si los émbolos y la obturación están limpios.

Compruebe la hermeticidad del aparato. Recomendamos usar el aparato verificador de estanqueidad de BRAND PLT unit. Alternativo: para ello, absorba una muestra y mantenga el aparato en posición vertical durante unos 10 segundos. En caso de que en la punta de la pipeta se forme una gota: consulte el apartado „¿Qué hacer en caso de avería?“ pág. 133.

### Desmontaje y limpieza

1. Desenrosque el vástago de la pipeta (S) de la empuñadura.
  2. Separe la unión magnética de ambos componentes tirando de los mismos.
  3. Destornille la parte superior de eyección (A) del vástago de la pipeta.
  4. Extraiga el vástago (D y B) de la parte inferior de eyección (E).
  5. Suelte los tornillos del casquillo de retención (B) y sáquelos.
- Nota:** ¡Los émbolos con guía de émbolos deben mantenerse unidos al casquillo de retención (B)!
6. Saque el muelle con la junta (C).
  7. Limpie las piezas ilustradas con una solución jabonosa o con isopropanol, y a continuación, aclárelas con agua destilada.
  8. Seque las piezas (temperatura máx. 120 °C/ 248 °F).
  9. Engrasa ligeramente los émbolos.
  10. Vuelva a montar las piezas enfriadas en el orden inverso al desmontaje. Apriete el casquillo de retención y la pieza superior de eyección (A, B) sólo con las manos.
  11. Realizar el recorrido de referencia (rEF).

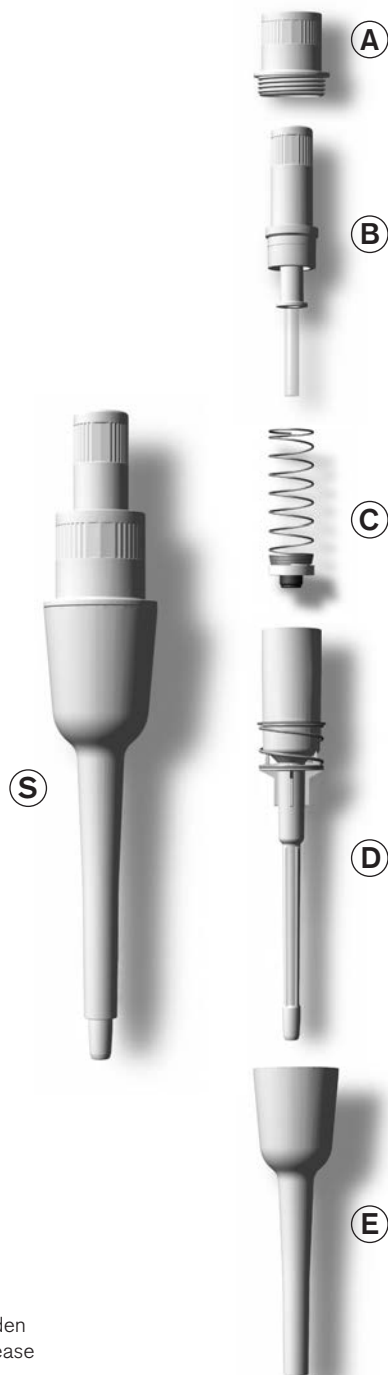

**Nota:** Todos los componentes individuales mostrados pueden adquirirse como piezas de repuesto (Referencias, véase la página 135).

Para garantizar el funcionamiento correcto de Transferpette® electronic, deberán realizarse trabajos de mantenimiento y limpieza regularmente.

## Mantenimiento

Compruebe que el cono de acoplamiento de puntas de pipetas no está dañado.

Compruebe también si los émbolos y la obturación están limpios.

Compruebe la hermeticidad del aparato. Recomendamos usar el aparato verificador de estanqueidad de BRAND PLT unit. Alternativo: para ello, absorba una muestra y mantenga el aparato en posición vertical durante unos 10 segundos. En caso de que en la punta de la pipeta se forme una gota: consulte el apartado „¿Qué hacer en caso de avería?“ pág. 133.

## Desmontaje y limpieza

1. Presionar los dos cierres laterales (J) y retirar la parte inferior del expulsor (G').
2. Desenrosque el vástago de la pipeta (H+I) de la empuñadura.
3. Separe la unión magnética de ambos componentes tirando de los mismos y retire la parte superior del expulsor (G).
4. Desenroscar la unidad de émbolo (H) y la parte inferior del vástago (I).
5. Retirar el anillo O de la unidad de émbolo y limpiarlo.

**Nota:** ¡No desmontar la unidad de émbolo (H) más de lo indicado!

6. Limpie unidad de émbolos (H) y la parte inferior del vástago (I) con una solución jabonosa o con isopropanol, y a continuación, aclárelas con agua destilada.
7. Seque las piezas (max. 120 °C/248 °F) y dejar enfriar.
8. Engrasar el anillo O adentro y afuera y volver a montarlo.
9. Vuelva a montar los componentes individuales en el orden inverso al desmontaje.
10. Posteriormente realizar el recorrido de referencia (rEF).

**Nota:** Todos los componentes individuales mostrados pueden adquirirse como piezas de repuesto (Referencias, véase la página 135).

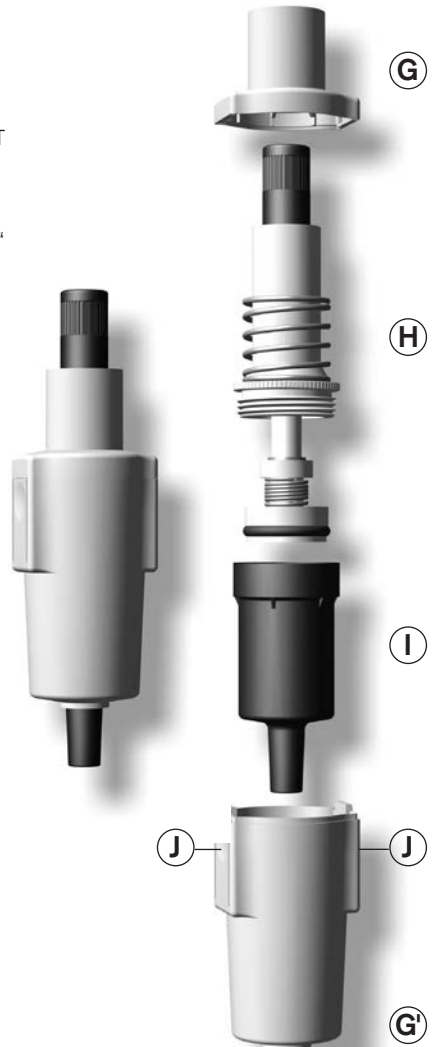

Una batería cargada completamente permite pipetear muestras de viscosidad y densidad similar al agua de forma continua durante unas 8 horas (corresponde a más de 4000 ciclos de pipeteado).

### Atención:

Antes de cargar la batería, deberá asegurarse de que el equipo de red es adecuado para el voltaje existente en el laboratorio. El aparato no deberá ser cargado en un entorno potencialmente explosivo. ¡La batería sólo podrá ser cargada en Transferpette® electronic!

### Recargar la batería

- Meta la clavija del cable de carga del equipo de red en la hembra de Transferpette® electronic. El proceso de carga se iniciará automáticamente.
- Durante el proceso de carga, verá que los bloques de indicación de la capacidad de batería se mueven continuamente de abajo a arriba. La batería estará cargada completamente cuando los bloques de indicación ya no se muevan.



### ¿Es posible pipetear durante el proceso de carga?

Durante el proceso de carga de la batería, se puede seguir trabajando con Transferpette® electronic.

Si la batería está completamente descargada, tendrá que esperar unos minutos hasta que la batería se haya cargado con la capacidad mínima necesaria para trabajar con el aparato de forma segura.

### Nota:

Los ajustes que se han realizado la última vez se guardan en el EEPROM del aparato. En caso de que la batería se haya vaciado completamente o al sustituir la misma por otra, estos ajustes se mantendrán en la memoria.

### Sustituir la batería

- Abra la tapa del compartimento de la batería, saque la batería y desenchufe la clavija de la hembra.
- Meta la clavija de la nueva batería en la hembra y coloque la nueva batería en el aparato.
- Vuelva a colocar la tapa del compartimento de la batería y ciérrela bien.



En caso de que el aparato no vaya a ser utilizado durante mucho tiempo, extraiga la batería del mismo.

## Cargar y cambiar la batería

### Indicación del nivel de batería tras haber insertado una nueva batería

- a) Tras haber insertado una batería, en la pantalla aparecerá la **indicación de capacidad completa con un marco parpadeante** (el aparato no reconocerá el estado de carga de la batería en un primer momento). Tras un tiempo de carga de 3,5 h (el tiempo equivalente a la carga completa segura de la batería), el marco dejará de parpadear.



#### Nota:

¡Al insertar una batería, cárguela siempre durante 3,5 h! Después de algunos ciclos de carga/descarga se proporciona la capacidad de carga completa.

## Función de regeneración de batería

### (Función Refresh)

Para prolongar la vida útil y aumentar la potencia de las baterías, Transferpette® electronic dispone de una función de regeneración (la función Refresh). Esta función permite descargar completamente y volver a cargar las baterías de forma controlada por el programa. Para optimizar la capacidad de potencia de las baterías, se recomienda aplicar la función Refresh de vez en cuando.

### Realizar función Refresh

- a) Meta la clavija (conexión) del equipo de red en la hembrilla de la parte superior de Transferpette® electronic prevista para ello.



- b) Pulse la flecha inferior durante más de 3 segundos. Durante la descarga, los bloques indicadores de capacidad de la batería se mueven continuamente de arriba a abajo.



- c) Tras haberse finalizado la descarga (puede durar hasta 3 h), volverá a iniciarse el proceso de carga (de 3,5 h) automáticamente. Durante la carga, los bloques indicadores de capacidad de la batería se mueven continuamente de abajo a arriba.







### Cancelar la función Refresh

Al pulsar cualquier tecla, el programa se cancelará. El aparato pasará automáticamente al modo estándar de pipeteado (PIP) y volverá al volumen nominal; el proceso normal de carga se iniciará automáticamente (véase la página 131). Asimismo, el programa se cancelará al desenchufar la hembrilla del bloque de alimentación. No cancelar la función Refresh al final del ciclo de descarga.

## ¿Qué hacer en caso de avería?

Al producirse una avería, en la pantalla podrá leer el aviso 'Err' y el número de error. Entonces, el aparato sólo reaccionará si pulsa la tecla Enter. Pulsando la tecla Enter se intenta iniciar de nuevo el aparato. Por tanto, automáticamente será necesario realizar un recorrido de referencia (rEF).

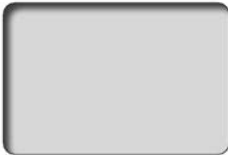
Avería	Avisio de fallo	Causa probable	¿Qué hacer?
El aparato no reacciona		La batería está vacía o averiada	Cargar batería al menos durante 5 min sin pulsar ninguna tecla; después, continuar trabajando sólo con cable de carga enchufado hasta que batería se haya recargado o sustituir la batería por otra
		Módulos electrónicos defectuosos	Enviar el aparato a reparación
El aparato no reacciona		Módulos electrónicos defectuosos	Enviar el aparato a reparación
El aparato no reacciona		Error de programación imprevisto	Confirmación de error pulsando la tecla Enter. El aparato volverá a iniciarse
El aparato no reacciona		El aparato no tiene batería	Colocar la batería
		Batería defectuosa	Sustituir la batería
		Módulos electrónicos defectuosos	Enviar el aparato a reparación
La punta gotea/ El aparato no es hermético o hay un error de volumen	—	Punta no adecuada	Utilice sólo puntas de calidad
		La punta no está bien fijada	Inserte la punta de forma que quede fija/otra pinza de cambio
		Embolo, vástago o obturación sucia o defectuosa	Limpie el aparato/ Sustituya la obturación. Engresarse el embolo.
Pantalla en negro		Descarga eléctrica	Sacar y colocar de nuevo la batería
		Módulos electrónicos defectuosos	Enviar el aparato a reparación

## Transferpette® electronic

Volumen	0,5-10 µl	2-20 µl	10-200 µl	50-1000 µl	250-5000 µl
<b>Con equipo de red (110-240V/50-60 Hz)</b>	Ref.	Ref.	Ref.	Ref.	Ref.
para Europa (continental)	7052 99	7053 00	7053 03	7053 06	7053 07
para Reino Unido/Irlanda	7053 09	7053 10	7053 13	7053 16	7053 17
para EE.UU./Japón	7053 19	7053 20	7053 23	7053 26	7053 27
para Australia	7053 29	7053 30	7053 33	7053 36	7053 37
<b>Sin equipo de red</b>	7053 39	7053 40	7053 43	7053 46	7053 47

## Equipo de red (110-240V/50-60 Hz)

	Ref.
para Europa (continental)	7053 50
para Reino Unido/Irlanda	7053 51
para EE.UU./Japón	7053 52
para Australia	7053 53

## Batería de repuesto

para Transferpette® electronic

<b>Ref.</b>	7055 00
-------------	---------

## Grasa de silicona

para Transferpette® electronic hasta 1000 µl

<b>Ref.</b>	7055 02
-------------	---------

## Grasa de silicona

para Transferpette® electronic 250 - 5000 µl

<b>Ref.</b>	7036 77
-------------	---------

## PLT unit

un aparato verificador de estanqueidad de pipeta

<b>Ref.</b>	7039 70
-------------	---------

## Soporte con equipo de red para

3 Transferpette® electronic hasta 1000 µl

Con equipo de red (110-240V/50-60 Hz)	Ref.
para Europa (continental)	7053 90
para Reino Unido/Irlanda	7053 91
para EE.UU./Japón	7053 92
para Australia	7053 93

## Puntas de pipeta de BRAND, sin esterilizar, PP

Volumen	Unidad por emb.	Ref.
<b>Empaquetadas sueltas</b>		
0,1 - 20 µl	2000	7320 02
0,5 - 20 µl	2000	7320 04
1 - 50 µl	2000	7320 06
2 - 200 µl	1000	7320 08
50 - 1000 µl	1000	7320 12
5 ml	200	7025 95
5 ml	1000	7026 00
<b>5 ml Tip-Box</b>	1 box de 28	7026 05

## Filtro para Transferpette® electronic

5 ml, 25 unidades por embalaje

<b>Ref.</b>	7046 52
-------------	---------

**Recambios para Transferpette® electronic hasta 1000 µl**

El diseño y las dimensiones de las piezas de repuesto según el volumen nominal correspondiente. (Ilustr. piezas de recambio Transferpette® electronic 10-200 µl).

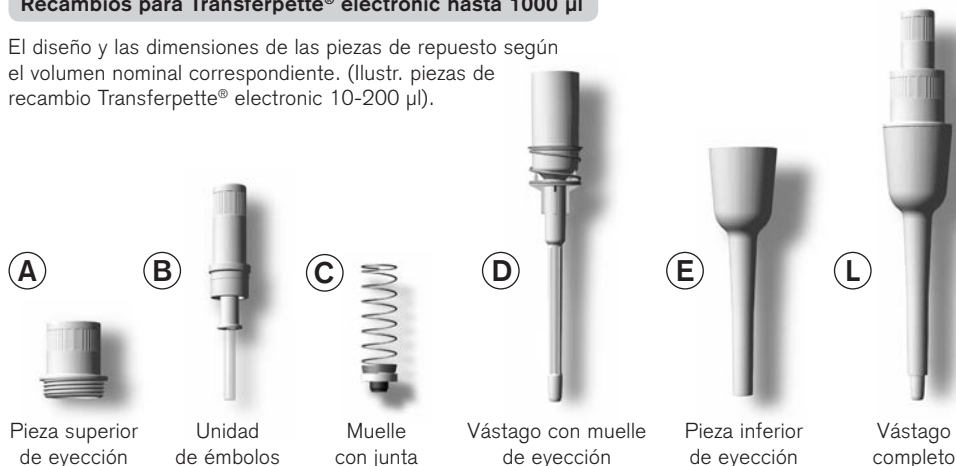

Volumen	A	B	C	D	E	L
0,5 - 10 µl	7055 10	7055 18	–	7055 38	7055 48	7055 28
2 - 20 µl	7055 10	7055 20	7055 30	7055 39	7055 50	7055 29
10 - 200 µl	7055 10	7055 22	7055 32	7055 37	7055 53	7055 46
50 - 1000 µl	7055 10	7055 24	7055 34	7055 41	7055 55	7055 47

**Recambios para Transferpette® electronic 250-5000 µl**

**Accesorios para Transferpette® electronic 10-200 µl y 50-1000 µl**



Las pinzas de cambio insertables (distanciadores) (F) y los vástagos de pipeta (K) con puntas de cono de acoplamiento flexibles permiten una óptima precisión de ajuste y una mínima fuerza de eyección con la mayoría de las puntas de pipeta comunes.

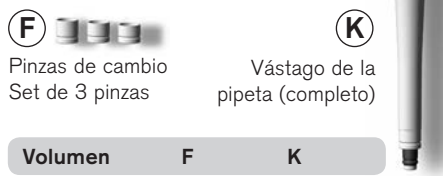

Volumen	G + G'	H	I
250 - 5000 µl	7299	7055 26	7032 47

Volumen	F	K
10 - 200 µl	7055 60	7055 43
50 - 1000 µl	7055 62	7055 45

## Envíos para reparación

**Atención:** Transportar materiales peligrosos sin autorización está prohibido por la ley.

- Limpiar y descontaminar el aparato con cuidado.
- Devuelva el instrumento incluya generalmente una descripción exacta del tipo de avería y de los medios utilizados. En caso de no indicar los medios usados no se puede reparar el instrumento.
- Los gastos y riesgos de la devolución corren a cargo del remitente.

### Fuera de los EE.UU. y Canadá:

- Rellenar la "Declaración sobre la ausencia de riesgos para la salud" y enviarla con el aparato al fabricante o al distribuidor. Pedir el formulario al proveedor o al fabricante, o se encuentran bajo [www.brand.de](http://www.brand.de) para un download.

### En los EE.UU. y Canadá:

- Haga el favor de dirigirse a BrandTech Scientific, Inc. para aclarar las condiciones de envío del aparato **antes** de enviarlo al servicio.
- Devuelva solamente los instrumentos limpiados y descontaminados con el Número de Autorización de Devolución marcado de forma bien visible en la parte exterior del paquete, enviándolo a la dirección indicada en la autorización antedicha.

## Direcciones de contacto

### BRAND GMBH + CO KG

Otto-Schott-Straße 25  
97877 Wertheim (Germany)  
Tel.: +49 9342 808-0  
Fax: +49 9342 808-98000  
E-Mail: [info@brand.de](mailto:info@brand.de)  
[www.brand.de](http://www.brand.de)

### EE.UU. y Canadá:

BrandTech® Scientific, Inc.  
11 Bokum Road  
Essex, CT 06426-1506 (USA)  
Tel.: +1-860-767 2562  
Fax: +1-860-767 2563  
[www.brandtech.com](http://www.brandtech.com)

### India:

BRAND Scientific Equipment Pvt. Ltd.  
303, 3rd Floor, 'C' Wing, Delphi  
Hiranandani Business Park, Powai  
Mumbai - 400 076 (India)  
Tel.: +91 22 42957790  
Fax: +91 22 42957791  
E-Mail: [info@brand.co.in](mailto:info@brand.co.in)  
[www.brand.co.in](http://www.brand.co.in)

### China:

BRAND (Shanghai) Trading Co., Ltd.  
Guangqi Culture Plaza  
Room 506, Building B  
No. 2899, Xietu Road  
Shanghai 200030 (P.R. China)  
Tel.: +86 21 6422 2318  
Fax: +86 21 6422 2268  
E-Mail: [info@brand.cn.com](mailto:info@brand.cn.com)  
[www.brand.cn.com](http://www.brand.cn.com)



### Servicio de calibración

Las normas ISO 9001 y las directivas BPL exigen el control regular de sus aparatos volumétricos. Nosotros recomendamos un control cada 3-12 meses. El intervalo depende de las exigencias individuales al instrumento. En el caso de uso frecuente o del uso de medios agresivos, se debe de controlar en intervalos más cortos.

Las instrucciones de calibrado detalladas se pueden descargar de la página [www.brand.de](http://www.brand.de) o [www.brandtech.com](http://www.brandtech.com) (véase 'Documentos técnicos').

Además, BRAND le ofrece la posibilidad de calibrar sus instrumentos por medio del servicio de calibrado de BRAND o por el laboratorio de calibrado DAkkS.

Mándenlo sencillamente los instrumentos a calibrar con la información qué tipo de calibrado desea. Recibirá los instrumentos con un certificado de fábrica o con un certificado de calibrado DAkkS después de pocos días. Puede obtener informaciones detalladas de su proveedor o directamente de BRAND. En la página [www.brand.de](http://www.brand.de) encontrará para descargar, los documentos de pedido (véase 'Documentos técnicos').

## Garantía

No seremos responsables de las consecuencias derivadas del trato, manejo, mantenimiento, uso incorrecto o reparación no autorizada del aparato, ni de las consecuencias derivadas del desgaste normal, en especial de partes susceptibles de abrasión, tales como émbolos, juntas hermeticas, valvulas, ni de la rotura de partes de vidrio o del incumplimiento de las instrucciones de manejo. Tampoco seremos responsables de los daños provocados de acciones no descritas en las instrucciones de manejo o por el uso piezas de repuesto o componentes no originales.

EE.UU. y Canadá:

Encontrará informaciones sobre la garantía en el sitio [www.brandtech.com](http://www.brandtech.com).

## Eliminación

---

El siguiente símbolo significa que al final de su vida útil, las pilas / acumuladores y aparatos electrónicos deben descartarse separadamente de los residuos domésticos (residuos municipales mezclados).

- Según la directiva UE 2002/96/CE del Consejo y Parlamento Europeo sobre residuos de aparatos eléctricos y electrónicos del 27 enero 2003 es necesario eliminar los aparatos eléctricos conforme a las normas correspondientes de la eliminación de residuos nacional.



- Las pilas o acumuladores contienen sustancias que pueden resultar perjudiciales para el medio ambiente y la salud humana. Según la directiva UE 2006/66/CE del Consejo y Parlamento Europeo sobre residuos de pilas o de acumuladores del 6 septiembre 2006 es necesario eliminarlos conforme a las normas correspondientes de la eliminación de residuos nacional. Eliminar la pila / el acumulador sólo cuando esté completamente descargado.

### ¡Advertencia!

No cortocircuitar el acumulador / la pila para descargarlo.

Salvo cambios técnicos, errores y errores de impresión.

	Pagina
Norme di sicurezza	140
Funzioni e limiti all'uso	141
Usi non previsti	141
Elementi funzionali	142
<b>I primi passi</b>	<b>143</b>
Regolazione del volume	144
Regolazione della velocità di aspirazione e di erogazione	145
Pipettaggio corretto	146
Programmi di pipettaggio	147
Modalità PIP	148
Modalità PIPmix	150
Modalità revPIP	152
Modalità Elettroforesi (GEL)	154
Modalità DISP	156
Verifica del volume	158
Tabella della precisione	159
<b>Easy Calibration (Calibrazione)</b>	<b>160</b>
Sterilizzazione in autoclave	162
Ciclo di riferimento (rEF)	162
Manutenzione e pulizia	163
Ricarica e sostituzione dell'accumulatore	165
Funzione di rigenera dell'accumulatore	166
Individuazione e soluzione dei problemi	167
Dati per l'ordinazione · Accessori · Parti di ricambio	168
Riparazione · Indirizzi di contatto	170
Servicio Calibrazione	171
Garanzia · Smaltimento	172

## Norme di sicurezza

Questo strumento può essere utilizzato con materiali, procedure e apparecchiature pericolosi. Le istruzioni per l'uso non possono però coprire tutte le eventuali problematiche di sicurezza che possono presentarsi. È responsabilità dell'utilizzatore osservare adeguate prescrizioni per la sicurezza e la salute e definire prima dell'uso le opportune limitazioni.



### Leggere attentamente prima dell'uso!

1. Prima di utilizzare lo strumento, ogni utilizzatore deve leggere ed osservare queste istruzioni per l'uso.
2. Osservare le avvertenze generali di pericolo e le norme di sicurezza. Ad esempio indossare indumenti, protezione per gli occhi e guanti protettivi.  
Se si lavora con di campioni infetti o pericolosi devono essere rispettate le procedure e le precauzioni standard di laboratorio.
3. Rispettare le indicazioni del produttore dei reagenti.
4. Non utilizzare lo strumento in ambiente potenzialmente esplosivo e non pipettare fluidi facilmente infiammabili.
5. Utilizzare lo strumento solo per il pipettaggio di liquidi e tenere conto dei limiti d'uso definiti e delle limitazioni all'uso. Osservare gli usi non previsti (pagina 141). In caso di dubbio, rivolgersi al produttore o al distributore.
6. Procedere sempre in modo che né l'utilizzatore né altre persone siano esposte a pericoli. Evitare spruzzi e utilizzare esclusivamente contenitori adatti.
7. Se si lavora con fluidi aggressivi, evitare il contatto con il foro del puntale.
8. Non forzare mai lo strumento.
9. Utilizzare solo parti di ricambio originali. Non apportare modifiche tecniche. Non smontare ulteriormente lo strumento, al di là di quanto previsto nelle istruzioni per l'uso!
10. Prima dell'uso controllare sempre che lo stato dello strumento sia regolare. In caso di anomalie dello strumento (ad esempio pistone poco scorrevole o mancanza di tenuta), interrompere immediatamente la pipetage e vedere il capitolo 'Individuazione e soluzione dei problemi' (pagina 167). Eventualmente rivolgersi al produttore.
11. L'accumulatore originale non deve essere sostituito con accumulatori non ricaricabili o con accumulatori ricaricabili di altri produttori.
12. Per la ricarica degli accumulatori al nichel-metal-idruro utilizzare esclusivamente l'alimentatore originale.
13. L' alimentatore deve essere protetto dall'umidità e deve essere usato solo per questo apparecchio.
14. Smaltire solo accumulatori completamente scarichi, rispettando le prescrizioni per lo smaltimento delle le batterie.

### Attenzione!

L'uso improprio dello strumento o dell'accumulatore (corto circuito, danni meccanici, surriscaldamento, alimentatore sbagliato, ecc.) può portare, in casi estremi, all'esplosione dell'accumulatore.

La Transferpette® electronic è una pipetta a pistone a cuscinetto d'aria, controllata da un microprocessore e alimentata a batteria, per il pipettaggio di soluzioni acquose di media densità e viscosità.

Nell'uso corretto dello strumento soltanto il puntale viene a contatto con il campione da dosare, mai la Transferpette® electronic.

### Limiti all'uso

Lo strumento può essere utilizzato per il pipettaggio di campioni con le seguenti limitazioni:

- Temperatura di uso da +15 °C a +40 °C (da 59 °F a 104 °F) (dello strumento e del reagente
  - per temperature diverse chiedere informazioni)
- tensione di vapore fino a 500 mbar
- viscosità: 260 mPa s

### Usi non previsti

L'utente è tenuto a verificare personalmente la compatibilità dello strumento con l'uso previsto.

Non usare mai lo strumento per il pipettaggio di liquidi che possono aggredire il polipropilene (gambo e puntali), il policarbonato-polibutilene-terefalato (alloggiamento) o EPDM (gambi della pipetta di ricambio flessibile). Evitare vapori aggressivi (pericolo di corrosione)!

L'impugnatura non può essere sterilizzata in autoclave!

### Limitazioni all'uso

I liquidi viscosi e bagnanti possono compromettere la precisione del volume. Ciò è valido anche per i liquidi la cui temperatura si discosta di più di  $\pm 5$  °C/ 41 °F dalla temperatura ambiente.

### Caratteristiche dell'accumulatore e dell'alimentatore

#### Accumulatore

Accumulatore al nichel-metal-idruro con 3 pile cilindriche di tipo AAA, 3,6 V, 700 mAh

#### Alimentatore

Tensione in uscita 6,5 V DC, 200 mA

## Elementi funzionali

La Transferpette® electronic è una pipetta a pistone, ottimizzata dal punto di vista ergonomico e della facilità d'uso, controllata da un microprocessore e alimentata a batteria.

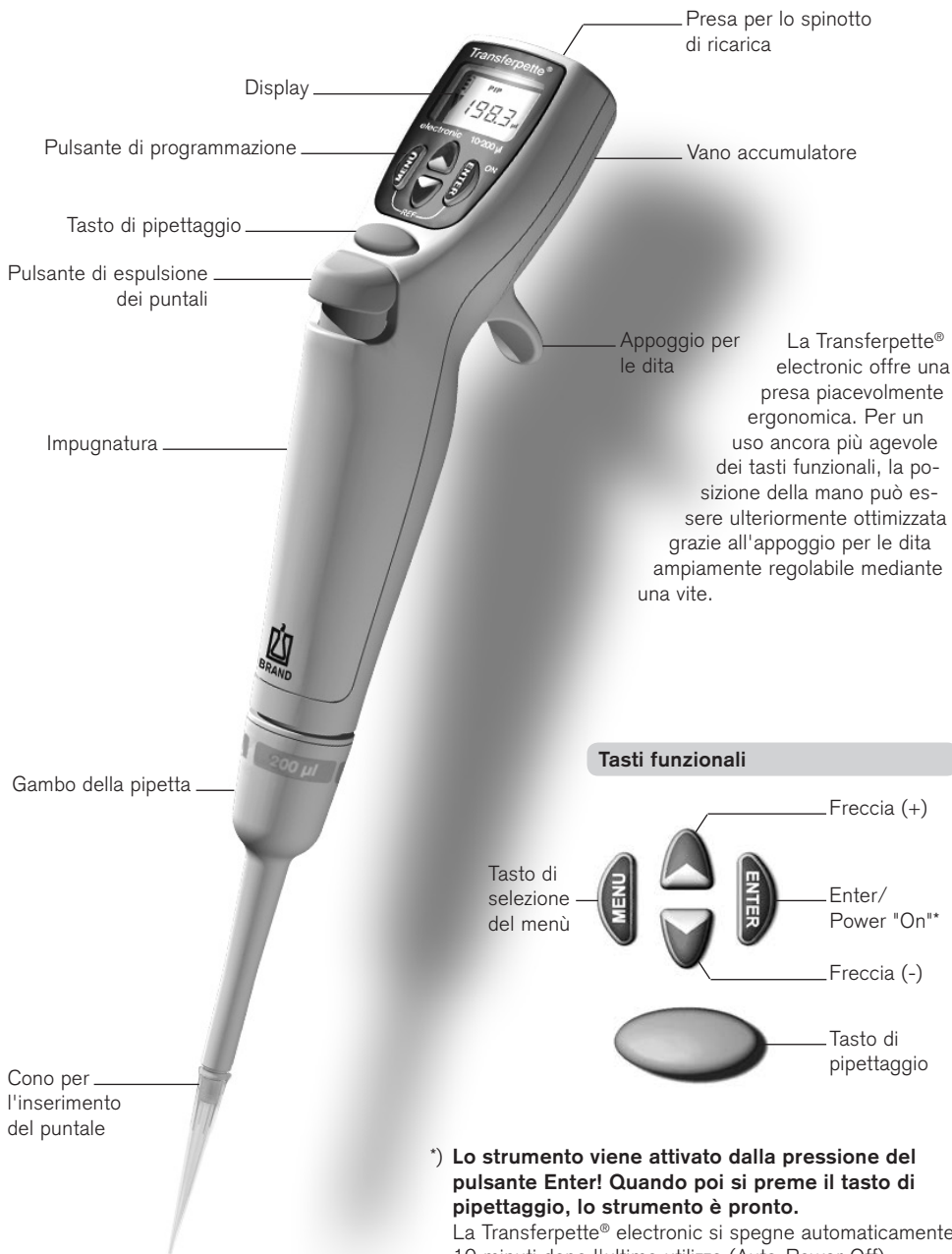

**C'è tutto nella confezione?**

Nella confezione sono contenuti: la vostra Transferpette® electronic, un accumulatore, l'alimentatore con il relativo cavo, olio al silicone, queste istruzioni per l'uso e 1 busta di campioni di puntali.

**Messa in funzione della Transferpette® electronic****1. Inserire l'accumulatore**

- Aprire il vano accumulatore.
- Inserire l'accumulatore. Assicurarsi che il contatto dell'accumulatore sia inserito correttamente nella presa dello strumento.
- Reinserire il coperchio e chiudere il vano accumulatore.

**2. Attivare lo strumento**

Subito dopo l'introduzione dell'accumulatore, la Transferpette® electronic richiede automaticamente un ciclo di riferimento. Premere il tasto di pipettaggio: il ciclo di riferimento viene eseguito e lo strumento è pronto!



Il Display mostra la modalità standard di pipettaggio (PIP) (impostazione di fabbrica) e il volume nominale corrente. (qui ad esempio 200,0 µl). Le velocità di aspirazione e di erogazione sono impostate di fabbrica al valore massimo. La semplice procedura di impostazione del volume e della velocità è descritta nelle pagine seguenti.

Modalità di pipettaggio

Visualizzazione della carica







Freccia per l'indicazione di "Aspirazione"

Indicazione del volume

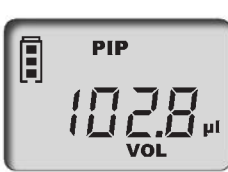

## Regolazione del volume

Il volume viene impostato in fabbrica al volume nominale della Transferpette® electronic e può essere modificato autonomamente in modo facile e veloce.

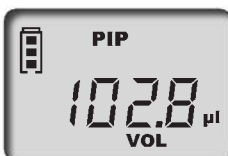
Cosa devo fare?	Come fare?	Quale tasto?	Cosa mostra il display?
<b>1. Attivare la scelta del volume</b>	Premendo una delle frecce si sceglie direttamente un volume. 'VOL' lampeggia.		
<b>2. Regolare il volume</b>			
<b>diminuire</b>	Premendo la freccia (-) si diminuisce il volume. Tenendo premuta la freccia aumenta la velocità della variazione del volume. 'VOL' lampeggia ancora.		
<b>aumentare</b>	Premendo la freccia (+) si aumenta il volume. Tenendo premuta la freccia aumenta la velocità della variazione del volume. 'VOL' lampeggia ancora.		
<b>3. Confermare il volume scelto</b>	Premere il tasto Enter. Il display mostra ora il nuovo volume impostato, qui ad esempio nella modalità standard PIP.		

### Importante:

Premendo il tasto menù si può interrompere qualsiasi procedura di regolazione! Il display salta quindi alla prossima possibile regolazione o alla visualizzazione di uscita.











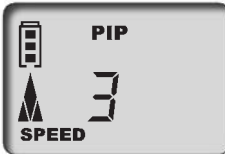

## Regolazione velocità di aspirazione/erogazione



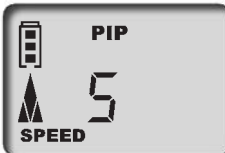





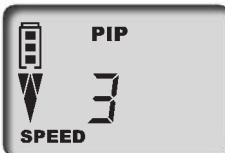

Le velocità di aspirazione e di erogazione possono essere impostate in modo indipendente. Richiamando il menù viene mostrata la velocità impostata per ultima. Sono disponibili 5 livelli di velocità.

Cosa devo fare?	Come fare?	Quale tasto?	Cosa mostra il display?
-----------------	------------	--------------	-------------------------

### Impostare la velocità di aspirazione

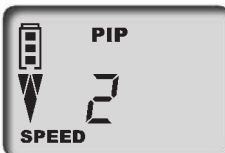
- |   |  |  |  |
|---|--|--|--|
| 1. Richiamare il menù                   | Premendo brevemente una volta il tasto Menù si accede al menù di impostazione della velocità di aspirazione. 'Speed' lampeggia.                                | 1x    |  |
| 2. Impostare la velocità di aspirazione | Premendo le frecce (+/-) si imposta il livello di velocità (ad esempio: livello 5). 'Speed' lampeggia ancora.  |       |  |
| 3. Confermare il livello della velocità | Premere il tasto Enter. Il display torna alla visualizzazione di base della modalità prescelta, qui ad esempio la visualizzazione della modalità standard PIP. |    1x |  |

### Impostare la velocità di erogazione

- |   |  |  |  |
|---|--|--|--|
| 1. Richiamare il menù                   | Premendo brevemente due volte il tasto Menù si accede al menù di impostazione della velocità di erogazione. 'Speed' lampeggia.                                 | 2x       |   |
| 2. Impostare la velocità di erogazione  | Premendo le frecce (+/-) si imposta il livello di velocità (ad esempio: livello 2). 'Speed' lampeggia ancora.  |       |  |
| 3. Confermare il livello della velocità | Premere il tasto Enter. Il display torna alla visualizzazione di base della modalità prescelta, qui ad esempio la visualizzazione della modalità standard PIP. |    1x |  |

Il volume viene impostato in fabbrica al volume nominale della Transferpette® electronic e può essere modificato autonomamente in modo facile e veloce (vedere pagina 144).

## Quick Start nella modalità di pipettaggio standard

### 1. Inserire il puntale

Scegliere il puntale adatto in base al range di volume prescelto e al color-code! Assicurarsi che il puntale sia inserito ermeticamente e saldamente sulla pipetta. Se si usa il gambo per pipetta flessibile, se necessario inserire l'adattatore alternativo. I puntali sono articoli monouso!

### 2. Aspirare il liquido

Tenere lo strumento verticale e immergere il puntale nel liquido per 2-3 millimetri.



Premere il tasto di pipettaggio per aspirare il liquido. La freccia del display è rivolta verso l'alto (aspirazione).



**Nota:** Per non aspirare aria mantenere ancora immerso il puntale per 1 sec.

### 3. Erogare il liquido

Alla fine dell'erogazione la freccia del display è rivolta verso il basso (erogazione).

Appoggiare il puntale della pipetta alla parete del recipiente. Tenere la pipetta ad un angolo di 30-45°.

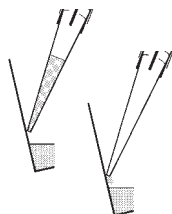

Premere di nuovo il tasto di pipettaggio per espellere completamente il liquido, con scarico automatico. Strofinare poi il puntale sulla parete.



### 4. Espellere il puntale

Tenere il gambo della pipetta sopra un recipiente adatto allo smaltimento e premere il tasto di espulsione dei puntali.



Tasto di espulsione dei puntali











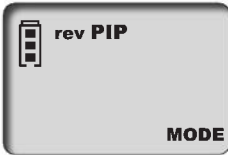

**Nota:**

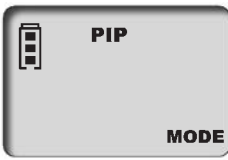

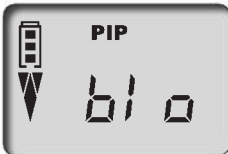
La norma ISO 8655 prescrive un risciacquo del puntale con un liquido di prova prima della procedura di pipettaggio del campione.



	Pagina
<b>1. Pipettaggio normale</b>	
Modalità <b>PIP</b> _____	<b>148</b>
Programma standard. Un volume prestabilito viene prima aspirato e poi erogato.	
<b>2. Mescolamento dei campioni</b>	
Modalità <b>PIPmix</b> _____	<b>150</b>
Programma per la risospensione di liquidi. Il campione viene aspirato e scaricato ripetutamente.	
<b>3. Pipettaggio inverso</b>	
Modalità <b>revPIP</b> _____	<b>152</b>
Programma particolarmente adatto per il pipettaggio di liquidi molto viscosi, ad alta tensione di vapore o schiumosi.	
<b>4. Pipettaggio per elettroforesi</b>	
Modalità <b>GEL</b> _____	<b>154</b>
Programma per aspirare i gel per elettroforesi. Un volume variabile di campione viene aspirato con velocità alta e regolabile, poi viene scaricato lentamente.	
<b>5. Dosaggio</b>	
Modalità <b>DISP</b> _____	<b>156</b>
Programma per il dosaggio di liquidi. Il volume aspirato viene erogato dose per dose.	

La modalità GEL non è disponibile per la Transferpette® electronic 1000 µl e 5000 µl.

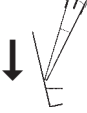
È il programma standard - un volume prestabilito viene prima aspirato e poi scaricato.  
La regolazione del volume e della velocità è descritta alle pagine 144 e 145.



Cosa devo fare?	Come fare?	Quale tasto?	Cosa mostra il display?
<b>1. Richiamare il menù</b>	Premendo brevemente tre volte il tasto Menù si accede alla selezione del programma. <b>'Mode'</b> lampeggia.		
<b>2. Impostare la modalità PIP</b>	Premere una delle frecce per scorrere la lista delle modalità finché compare <b>'PIP'</b> . <b>'Mode'</b> lampeggia ancora.		
<b>3. Confermare la modalità PIP</b>	Premere il tasto Enter. Il Display mostra ora <b>'blo'</b> per blow-out (scarico).		
<b>4. Preparare il pipettaggio</b>	Premere una volta il tasto di pipettaggio per portare il pistone alla sua posizione di partenza. La freccia del display è rivolta verso l'alto (aspirazione).		
<b>5. Aspirare il liquido</b> 	Premere una volta il tasto di pipettaggio per aspirare il liquido.		



Cosa devo fare?	Come fare?	Quale tasto?	Cosa mostra il display?
<p><b>6. Erogare il liquido</b></p> 	<p>Premere una volta il tasto di pipettaggio per erogare il liquido. La freccia del display è rivolta verso il basso (erogazione).</p>		

<p><b>7. Attivare lo scarico?</b></p>	<p><b>Non dovete fare niente!</b> Nel pipettaggio in modalità PIP lo scarico (blow-out) è automatico!</p>		
---------------------------------------	---	---	--

## Attivare lo scarico direttamente

Se necessario, lo scarico (blow-out) può essere attivato in qualunque momento anche direttamente.

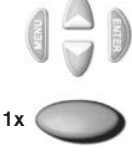
<p><b>1. Richiamare la funzione di scarico</b></p>	<p>Premere il tasto Enter. Il display mostra 'blo' per blow-out (scarico).</p>		
--	--	--	---

<p><b>2. Attivare lo scarico</b></p>	<p>Premere una volta il tasto di pipettaggio per attivare lo scarico. Il display salta alla modalità di pipettaggio già impostata (posizione iniziale).</p>		
--------------------------------------	---	---	--











**Nota:**

Nello scarico (blow-out) il pistone si sposta verso il basso completamente. Assicurarsi che i possibili residui vengano scaricati senza creare pericolo. **Tenendo premuto il tasto di pipettaggio si tiene premuto in basso il pistone, evitando così l'aspirazione accidentale del liquido. Rilasciandolo si riporta il pistone alla posizione di partenza.**

Programma per la risospensione di liquidi.

Il campione viene aspirato ed erogato ripetutamente.

La regolazione del volume e della velocità è descritta alle pagine 144 e 145.

Cosa devo fare?	Come fare?	Quale tasto?	Cosa mostra il display?
1. Richiamare il menù	Premendo brevemente tre volte il tasto Menù si accede alla selezione del programma. <b>'Mode'</b> lampeggia.	3x 	
2. Impostare la modalità PIPmix	Premere una delle frecce per scorrere la lista delle modalità finché compare <b>'PIPmix'</b> . <b>'Mode'</b> lampeggia ancora.		
3. Confermare la modalità PIPmix	Premere il tasto Enter. Il display mostra ora <b>'blo'</b> per blow-out (scarico).		
4. Preparare il pipettaggio	Premere una volta il tasto di pipettaggio per portare il pistone alla sua posizione di partenza. La freccia del display è rivolta verso l'alto (aspirazione).		
5. Aspirare il liquido	Premere una volta il tasto di pipettaggio per aspirare il liquido.		

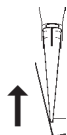

Cosa devo fare?	Come fare?	Quale tasto?	Cosa mostra il display?
-----------------	------------	--------------	-------------------------

**6. Erogare il liquido in modalità PIPmix**

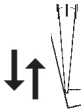

Premere il tasto di pipettaggio per attivare una sequenza di erogazioni e aspirazioni del liquido. Sul display si alternano le frecce di indicazione dell'aspirazione e dell'erogazione e viene indicato il numero di cicli eseguiti.



**7. Fine del pipettaggio**















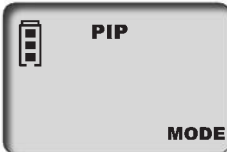



















Premere una volta il tasto di pipettaggio per erogare il liquido e attivare lo scarico (blow-out).

Dopo lo scarico (blow-out) dei residui di liquido, il display salta alla modalità di pipettaggio già impostata (posizione iniziale).







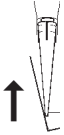
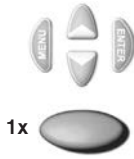

**Nota:** Il display mostra al massimo 19 cicli.

Programma particolarmente adatto per il pipettaggio di liquidi molto viscosi, ad alta tensione di vapore o schiumosi. La regolazione del volume e della velocità è descritta alle pagine 144 e 145.









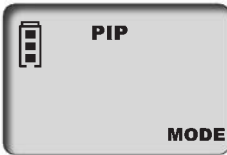

Cosa devo fare?	Come fare?	Quale tasto?	Cosa mostra il display?
1. Richiamare il menù	Premendo brevemente tre volte il tasto Menù si accede alla selezione del programma. 'Mode' lampeggia.	3x     	
2. Impostare la modalità revPIP	Premere una delle frecce per scorrere la lista delle modalità finché compare 'revPIP'. 'Mode' lampeggia ancora.	    	
3. Confermare la modalità revPIP	Premere il tasto Enter. Il Display mostra ora 'blo' per blow-out (scarico).	    1x 	
4. Preparare il pipettaggio	Premere una volta il tasto di pipettaggio per portare il pistone alla sua posizione di partenza. La freccia del display è rivolta verso l'alto (aspirazione).	    1x 	
5. Aspirare il liquido	Premere ancora una volta il tasto di pipettaggio per aspirare un volume un po' maggiore di quello impostato.	    1x 	
6. Erogare il liquido in modalità revPIP	Premere una volta il tasto di pipettaggio per erogare. La freccia del display è rivolta verso il basso (erogazione). Ora il volume impostato viene erogato e rimane un po' di liquido nel puntale.	    1x 	







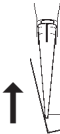



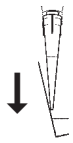





Cosa devo fare?	Come fare?	Quale tasto?	Cosa mostra il display?
<p><b>7. Aspirare di nuovo il liquido in modalità revPIP</b></p> 	<p>Premendo ancora una volta il tasto di pipettaggio viene ora aspirato di nuovo il volume impostato. (La successiva pressione del tasto di pipettaggio eroga di nuovo il volume, e così via)</p>		
<p><b>8. Attivare lo scarico</b></p>	<p>Dopo l'ultimo pipettaggio premere il tasto Enter. Il Display mostra ora di nuovo 'blo' per blow-out (scarico).</p>		
	<p>Premere una volta il tasto di pipettaggio per attivare lo scarico (blow-out) ed espellere i residui di liquido.</p>		
<p><b>9. Fine del pipettaggio</b></p>	<p>Dopo lo scarico (blow-out) dei residui di liquido, il display salta alla modalità di pipettaggio già impostata (posizione iniziale).</p>		

Programma per aspirare i gel per elettroforesi. Un volume variabile di campione viene aspirato con velocità alta e regolabile, poi viene erogato lentamente.

La regolazione del volume e della velocità è descritta alle pagine 144 e 145.















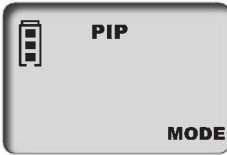





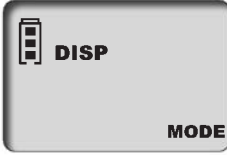













Cosa devo fare?	Come fare?	Quale tasto?	Cosa mostra il display?
1. Richiamare il menù	Premendo brevemente tre volte il tasto Menù si accede alla selezione del programma. 'Mode' lampeggia.	3x 	
2. Impostare la modalità GEL	Premere una delle frecce per scorrere la lista delle modalità finché compare 'GEL'. 'Mode' lampeggia ancora.		
3. Confermare la modalità GEL	Premere il tasto Enter. Il Display mostra ora 'blo' per blow-out (scarico).	 1x	
4. Preparare il pipettaggio	Premere una volta il tasto di pipettaggio per portare il pistone alla sua posizione di partenza. La freccia del display è rivolta verso l'alto (aspirazione).	 1x	
5. Aspirare il liquido	Premere una volta il tasto di pipettaggio per aspirare il liquido. Il volume impostato viene aspirato.	 1x	
	<b>Aspirare un volume maggiore</b> Per aspirare più liquido di quanto impostato (fino ad un massimo del 110 % del volume nominale), tenere premuto il tasto di pipettaggio durante l'aspirazione, finché viene aspirato il volume desiderato. Il display mostra un rombo.	 tenere premuto	











Cosa devo fare?	Come fare?	Quale tasto?	Cosa mostra il display?
<p><b>6. Erogare il liquido in modalità GEL</b></p> 	<p>Premere una volta brevemente il tasto di pipettaggio. Il display mostra un rombo. Il volume aspirato viene erogato lentamente.</p>	 1x 	
	<p><b>Interrompere l'erogazione</b> L'erogazione del campione può essere interrotta mediante pressione ripetuta del tasto di pipettaggio. In questo caso il display mostra il volume della quantità erogata.</p>	 1x 	
<p><b>7. Attivare lo scarico</b></p>	<p>Dopo l'ultimo pipettaggio premere il tasto Enter. Il Display mostra ora di nuovo 'blo' per blow-out (scarico).</p>	 1x 	
	<p>Premere una volta il tasto di pipettaggio per attivare lo scarico (blow-out) ed espellere i residui di liquido.</p>	 1x 	
<p><b>8. Fine del pipettaggio</b></p>	<p>Dopo lo scarico (blow-out) dei residui di liquido, il display salta alla modalità di pipettaggio già impostata (posizione iniziale).</p>		

**Nota:**

La modalità GEL richiede velocità di erogazione molto basse per evitare di creare turbolenza. Per assicurare un'erogazione ottimale la velocità di erogazione è impostata in fabbrica. È sensibilmente ridotta rispetto al livello 1 e non può essere impostata autonomamente dall'utilizzatore.

Programma per l'erogazione dose per dose del liquido aspirato.  
Viene aspirato un po' più di liquido di quanto richiesto in base al calcolo.  
La regolazione della velocità è descritta a pagina 145.

Cosa devo fare?	Come fare?	Quale tasto?	Cosa mostra il display?
1. Richiamare il menù	Premendo brevemente tre volte il tasto Menù si accede alla selezione del programma. 'Mode' lampeggia.	3x     	
2. Impostare la modalità DISP	Premere una delle frecce per scorrere la lista delle modalità finché compare 'DISP'. 'Mode' lampeggia ancora.	    	
3. Confermare la modalità DISP	Premere il tasto Enter. Il Display mostra ora 'blo' per blow-out (scarico).	    1x 	
4. Preparare il dosaggio	Premere una volta il tasto di pipettaggio per portare il pistone alla sua posizione di partenza. La freccia del display è rivolta verso l'alto (aspirazione).	    1x 	
5. Impostare il volume parziale	Premendo le frecce (+/-) si regola il volume. Tenendo premuta la freccia aumenta la velocità della variazione del volume. 'VOL' lampeggia.	  +  -  	
6. Confermare il volume parziale	Premere il tasto Enter. Il display mostra il nuovo volume parziale impostato. 'steps' lampeggia. Viene visualizzato il massimo numero di step consentito.	    1x 	

Cosa devo fare?	Come fare?	Quale tasto?	Cosa mostra il display?
7. Impostare il numero di step	Premendo le frecce (+/-) si regola il numero di step. 'steps' lampeggia ancora.		
8. Confermare il numero di step	Premere il tasto Enter. Il display mostra il numero di step impostati.		
9. Aspirare il liquido	Premere una volta il tasto di pipettaggio per aspirare il liquido.		
10. Erogare il liquido	Ad ogni pressione del tasto di pipettaggio corrisponde uno step di erogazione. La freccia del display è rivolta verso il basso (erogazione). L'indicazione di step mostra il numero di step rimanenti.		
11. Attivare lo scarico	Dopo l'ultimo step di erogazione premere il tasto Enter. Il Display mostra ora 'blo' per blow-out (scarico). Infine premere ancora una volta il tasto di pipettaggio per attivare lo scarico (blow-out) (vedere anche a pagina 155).		
12. Fine del dosaggio	Dopo lo scarico (blow-out) dei residui di liquido, il display salta alla modalità di pipettaggio già impostata (posizione iniziale).		

## Verifica del volume

Si consiglia, in base all'impiego, una verifica dello strumento ogni 3-12 mesi. L'intervallo dipende comunque dalle prestazioni richieste allo strumento.

La verifica gravimetrica del volume va eseguita secondo la seguente procedura, secondo le norme DIN EN ISO 8655, parte 6.

### 1. Impostare il volume nominale

Impostare il volume massimo indicato sullo strumento.  
Per la procedura vedere a pagina 144.

### 2. Condizionare la pipetta

Condizionare la pipetta prima della verifica aspirando e rilasciando il liquido di prova (H<sub>2</sub>O distillata) con il puntale per cinque volte. Poi espellere il puntale.

### 3. Eseguire la verifica

- Inserire il puntale nuovo e risciacquarlo una volta con il liquido di prova.
- Aspirare il liquido di prova e pipettarlo nel contenitore per la pesata.
- Pesare la quantità di campione pipettata con una bilancia analitica. (Rispettare le istruzioni per l'uso del produttore della bilancia).
- Calcolare il volume pipettato, tenendo conto della temperatura.
- Eseguire almeno 10 pipettaggi e relative pesate in 3 range di volume (100 %, 50 %, 10 %).

#### Calcolo (per il volume nominale)

$x_i$  = risultato della pesata  
 $n$  = numero delle pesate

$Z$  = fattore di correzione  
(es. 1,0029 µl/mg a 20 °C, 1013 hPa)

$$\text{Valor médio } \bar{x} = \frac{\sum x_i}{n}$$

$$\text{Volume médio } \bar{V} = \bar{x} \cdot Z$$

#### Accuratezza\*

$$A\% = \frac{\bar{V} - V_0}{V_0} \cdot 100$$

$V_0$  = volume nominale

#### Deviazione standard

$$s = Z \cdot \sqrt{\frac{\sum (x_i - \bar{x})^2}{n - 1}}$$

#### Coefficiente di variazione\*

$$CV\% = \frac{100 s}{\bar{V}}$$

\*) = Calcolo dell'accuratezza (A%) e del coefficiente di variazione (CV%):  
A% e CV% vengono calcolati in base a formule del controllo statistico di qualità.

## Tabella della precisione

I valori finali si riferiscono ai volumi nominali (= volumi massimi) riportati sullo strumento e i volumi parziali indicati, con pipetta, ambiente e acqua distillata alla stessa temperatura (20 °C/68 °F). Secondo la norma DIN EN ISO 8655.



20 °C  
Ex

### Precisione della Transferpette® electronic

Range di volume $\mu\text{l}$	Volume parziale $\mu\text{l}$	A* $\leq \pm \%$	CV* $\leq \%$	Divisione $\mu\text{l}$	Tipo di puntale rac., $\mu\text{l}$
0,5 - 10	10	1,0	0,4	0,01	0,5 - 20
	5	1,5	0,8		
	1	5,0	2,0		
2 - 20	20	1,0	0,4	0,02	0,5 - 20
	10	1,5	0,8		
	2	5,0	2,5		
10 - 200	200	0,8	0,2	0,2	2 - 200
	100	1,2	0,3		
	20	4,0	0,6		
50 - 1000	1000	0,6	0,2	1,0	50 - 1000
	500	1,0	0,3		
	100	3,0	0,6		
250 - 5000	5000	0,6	0,2	5,0	500 - 5000
	2500	1,0	0,3		
	500	3,0	0,6		

\* A = Accuratezza, CV = Coefficiente di variazione

#### Nota:

Lo strumento è contrassegnato in conformità con la legislazione tedesca di misura e tarature, come previsto dal relativo regolamento:

**DE-M** 19

Indicazione DE-M (DE per Germania), incorniciata da un rettangolo, più le ultime due cifre dell'anno nel quale è stata effettuata la taratura (qui: 2019).

#### Nota:

Le Procedure operative standard (SOP) e una versione demo del software di calibrazione EASYCAL™ 4.0 possono essere scaricate da [www.brand.de](http://www.brand.de).

### La modalità "CAL"

#### Calibrazione

È impostato il volume nominale o uno specifico volume, ad esempio 200,0 µl, con modalità di pipettaggio standard (PIP) (vedere pagine 144, 148 per la procedura). Ad esempio: volume corrispondente a la verifica del volumen 201,3 µl.















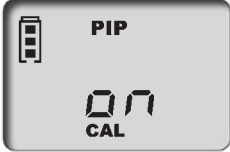

Cosa devo fare?	Come fare?	Quale tasto?	Cosa mostra il display?
1. Richiamare la modalità CAL	Tenendo premuto (più di 3 sec.) il tasto Menù si richiama la modalità CAL. Il display mostra "off". 'CAL' lampeggia.	1x >3s 	
2. Attivare la modalità CAL	Premere una delle frecce per attivare la modalità CAL. L'indicazione da "off" diventa "on". 'CAL' lampeggia ancora.		
3. Confermare la modalità CAL	Premere il tasto Enter. Il display mostra ora il volume impostato per il pipettaggio. 'CAL' lampeggia.	1x	
4. Regolare il volume	Mediante le frecce (+/-) impostare il volume che è stato in precedenza determinato e verificato. 'CAL' lampeggia.		
5. Confermare il volume	Premere il tasto Enter. Sul display compaiono il volume misurato e quello corretto. Il simbolo CAL è ora fisso a conferma che la calibrazione è stata effettuata.	1x	



## Ripristino delle impostazioni di fabbrica

Il simbolo CAL fisso sul display indica che è stata eseguita una calibrazione.



Cosa devo fare?	Come fare?	Quale tasto?	Cosa mostra il display?
1. Richiamare la modalità CAL	Tenendo premuto (più di 3 sec.) il tasto Menù si richiama la modalità CAL. Il display mostra "on". 'CAL' lampeggia.	1x >3s    	
2. Terminare la modalità CAL	Premere una delle frecce per disattivare la modalità CAL. Il display passa da "on" a "off". 'CAL' lampeggia ancora.	   	
3. Ripristinare le impostazioni di fabbrica	Premere il tasto Enter. Il simbolo CAL fisso è scomparso. Lo strumento ha ora di nuovo l'impostazione di fabbrica.	    1x	

### Importante:

Con la calibrazione della Transferpette® electronic viene eseguito un offset del volume, cioè il volume viene modificato di una stessa quantità nell'intero range di volume della pipetta. Si raccomanda di eseguire la calibrazione al 50% del volume nominale.

### Nota:

Lo strumento è calibrato in modo permanente per soluzioni acquose, ma può anche essere calibrato per soluzioni con diversa densità, viscosità e temperatura. La Transferpette® electronic può essere calibrata in qualsiasi modalità (con l'eccezione della modalità GEL).

## Sterilizzazione in autoclave

È possibile sterilizzare in autoclave il gambo della Transferpette® electronic a 121 °C (250 °F), 2 bar assoluti e tempo di permanenza di almeno 15 min per DIN EN 285.

**Attenzione:** L'impugnatura non può essere sterilizzata in autoclave!

1. Espellere il puntale della pipetta.
2. Svitare il gambo dall'impugnatura.
3. Sterilizzare tutto il gambo senza ulteriore smontaggio.
4. Lasciar raffreddare ed asciugare completamente il gambo della pipetta.
5. Avvitare di nuovo il gambo della pipetta all'impugnatura.
6. Eseguire un ciclo di riferimento (rEF).

**Nota:** È responsabilità dell'utilizzatore controllare l'efficacia della sterilizzazione in autoclave. Per una maggiore sicurezza servirsene della sterilizzazione a vuoto. Consigliamo l'uso di sacchetti appositi per la sterilizzazione.

In caso di frequenti trattamenti in autoclave del gambo, ingrassare il pistone e la guarnizione, per una maggiore scorrevolezza, con grasso al silicone fornito con lo strumento.

## Ciclo di riferimento (rEF)

Dopo ogni sostituzione del gambo della pipetta eseguire un ciclo di riferimento. Il ciclo di riferimento serve ad assicurare il corretto accoppiamento del pistone.



Cosa devo fare?	Come fare?	Quale tasto?	Cosa mostra il display?
1. <b>Richiamare la modalità rEF</b>	Premere contemporaneamente i tasti Menù e Enter per attivare la modalità rEF.		
2. <b>Eseguire il ciclo di riferimento</b>	Premere una volta il tasto di pipettaggio per attivare il ciclo di riferimento. Si sente distintamente il rumore del funzionamento.		

**Nota:** Dopo il ciclo di riferimento il display torna automaticamente al programma impostato in precedenza.

Per assicurare un funzionamento perfetto, la Transferpette® electronic dovrebbe essere sottoposta regolarmente a manutenzione e pulizia.

### Manutenzione

Controllare che il cono per l'inserimento del puntale non sia danneggiato.

Controllare che il pistone e la guarnizione non siano sporchi.

Controllare la tenuta dello strumento: Raccomandiamo utilizzare lo strumento per prove di tenuta PLT unit di BRAND. Alternativo: aspirare del campione e tenere lo strumento verticale per circa 10 secondi. Se si forma una goccia sul puntale: "Individuazione e soluzione dei problemi", pagina 167.

### Smontaggio e pulizia

1. Svitare il gambo (S) dall'impugnatura.
2. Tirare per scollegare la connessione magnetica tra i due componenti.
3. Svitare la parte superiore dell'espulsore (A) dal gambo.
4. Estrarre il gambo (D e B) dalla parte inferiore dell'espulsore (E).
5. Svitare la ghiera di ritenuta (B).
 

**Nota:** Il pistone e la sua guida rimangono sulla ghiera di ritenuta (B)!
6. Rimuovere la molla con la guarnizione (C).
7. Pulire le parti in figura con soluzione saponata o isopropanolo e poi sciacquare con acqua distillata.
8. Asciugare i componenti (max. 120°C/248 °F).
9. Ingrassare al pistone un velo del grasso.
10. Rimontare i componenti raffreddati seguendo l'ordine inverso. Avvitare a mano la ghiera di ritenuta e la parte superiore dell'espulsore (A, B), senza forzare.
11. Eseguire un ciclo di riferimento (rEF)

**Nota:** Tutti i componenti mostrati possono essere acquistati come parti di ricambio (vedere "Dati per l'ordinazione", pag. 169).

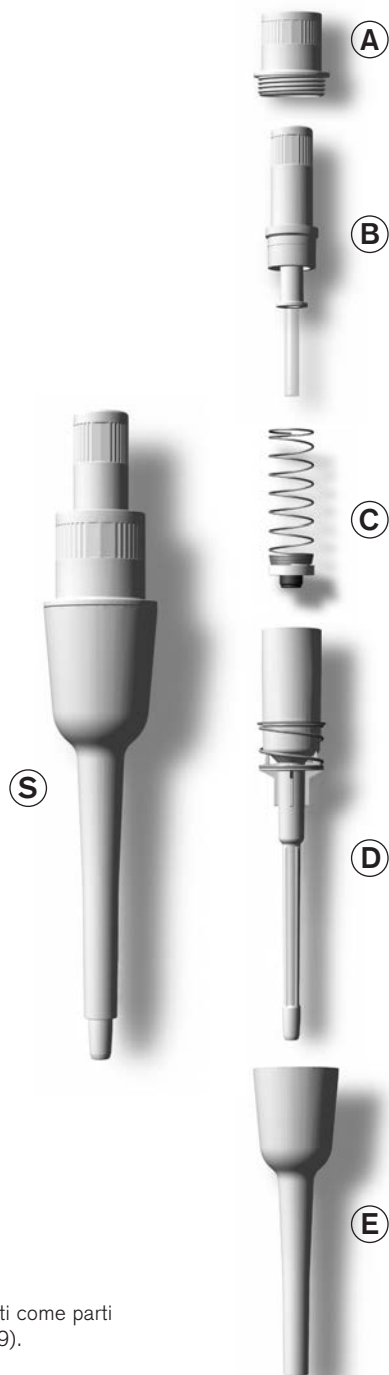

Per assicurare un funzionamento perfetto, la Transferpette® electronic dovrebbe essere sottoposta regolarmente a manutenzione e pulizia.

### Manutenzione

Controllare che il cono per l'inserimento del puntale non sia danneggiato.

Controllare che il pistone e la guarnizione non siano sporchi.

Controllare la tenuta dello strumento: Raccomandiamo utilizzare lo strumento per prove di tenuta PLT unit di BRAND. Alternativo: aspirare del campione e tenere lo strumento verticale per circa 10 secondi. Se si forma una goccia sul puntale: "Individuazione e soluzione dei problemi", pagina 167.

### Smontaggio e pulizia

1. Premere contemporaneamente le chiusure laterali (J) e rimuovere la parte inferiore dell'espulsore (G').
  2. Svitare il gambo della pipetta (H+I) dall'impugnatura.
  3. Tirare per scollegare la connessione magnetica tra i due componenti e rimuovere la parte superiore dell'espulsore (G).
  4. Svitare l'assieme del pistone (H) e la parte inferiore del gambo (I).
  5. Rimuovere l'O-Ring dall'assieme del pistone e pulirlo.
- Nota:** Non smontare ulteriormente l'assieme del pistone (H)!
6. Pulire l'assieme del pistone (H) e la parte inferiore del gambo (I) con soluzione saponata o con isopropanolo, poi sciacquarli con acqua distillata.
  7. Asciugare i componenti (max. 120 °C/248 °F) e farli raffreddare.
  8. Ingrassare con cura l'O-Ring all'interno e all'esterno e infilarlo sul pistone.
  9. Rimontare i componenti seguendo l'ordine inverso.
  10. Eseguire un ciclo di riferimento (rEF).

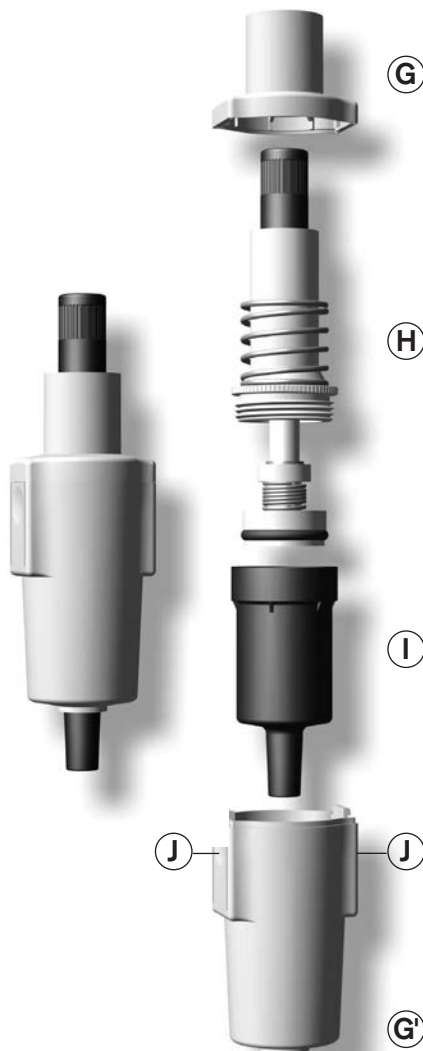

**Nota:** Tutti i componenti qui mostrati possono essere acquistati come parti di ricambio (vedere "Dati per l'ordinazione", pag. 169).

## Ricarica e sostituzione dell'accumulatore

Un accumulatore completamente carico consente un pipettaggio continuativo (più di 4000 cicli) per circa 8 ore con campioni con viscosità e densità analoga all'acqua.

### Attenzione!

Prima di eseguire la ricarica, controllare che l'alimentatore sia compatibile con la tensione disponibile in laboratorio. Non usare lo strumento in ambiente potenzialmente esplosivo. L'accumulatore può essere ricaricato solo nella Transferpette® electronic!

### Ricarica dell'accumulatore

- a) Inserire lo spinotto del cavo dell'alimentatore nell'apposita presa che si trova nella parte alta della Transferpette® electronic. La ricarica parte automaticamente.
- b) Durante la ricarica, le tacche dell'indicatore di carica dell'accumulatore si muovono continuamente dal basso verso l'alto. L'accumulatore è completamente carico quando le tacche dell'indicatore si fermano.



### Pipettare durante la ricarica dell'accumulatore?

Durante la ricarica si può continuare a lavorare con la Transferpette® electronic. Quando l'accumulatore è completamente scarico, bisogna attendere qualche minuto affinché venga raggiunto il livello minimo di carica richiesto per un funzionamento sicuro dello strumento.

**Nota:** Le ultime impostazioni dello strumento vengono memorizzate nella sua EEPROM. In caso di scarica completa o di sostituzione dell'accumulatore tali impostazioni sono quindi salvate!

### Sostituzione dell'accumulatore

- a) Aprire il vano, rimuovere l'accumulatore e sfilare il contatto dalla presa.
- b) Inserire il contatto del nuovo accumulatore nella presa e inserire il nuovo accumulatore.
- c) Reinscrivere il coperchio e chiudere il vano accumulatore.



Rimuovere l'accumulatore nel caso di un'interruzione prolungata dell'uso.

## Ricarica e sostituzione dell'accumulatore

### Visualizzazione della carica dopo la sostituzione dell'accumulatore

- a) Dopo la sostituzione dell'accumulatore appare **sul display l'indicazione della carica completa** con contorno lampeggiante (lo strumento non ha ancora rilevato il livello di carica). Dopo un tempo di ricarica di 3,5 ore – sicuramente sufficiente alla ricarica completa – il contorno smette di lampeggiare.



**Note:** Dopo aver inserito l'accumulatore, ricaricarlo per almeno 3,5 ore. La carica completa richiesta si raggiunge dopo vari cicli di carica/ scarica.

## Funzione di rigenera dell'accumulatore

### (funzione Refresh)

Per prolungare la durata dell'accumulatore e migliorarne le prestazioni, la Transferpette® electronic dispone di una funzione di rigenera dell'accumulatore (funzione Refresh). Questa funzione consiste nella ricarica e scarica completa dell'accumulatore, pilotata da software. Si consiglia di usare ogni tanto la funzione Refresh, per ottimizzare le prestazioni dell'accumulatore.

### Esecuzione della funzione Refresh

- a) Inserire lo spinotto del cavo dell'alimentatore nell'apposita presa che si trova nella parte alta della della Transferpette® electronic.



- b) Premere la freccia verso il basso per più di 3 sec. Durante la scarica le tacche dell'indicatore si muovono continuamente dall'alto verso il basso.



- c) Dopo la scarica (fino a 3 ore) inizia automaticamente la ricarica (3,5 ore). Durante la ricarica, le tacche dell'indicatore si muovono continuamente dal basso verso l'alto.







### Interruzione del funzione Refresh

Premendo un tasto qualsiasi il programma viene terminato. Lo strumento passa automaticamente alla modalità di pipettaggio standard (PIP), con volume nominale. Inizia automaticamente la ricarica normale (vedere pag. 165). Il programma termina anche quando si stacca lo spinotto dell'alimentatore. L'interruzione della funzione Refresh non deve essere eseguita alla fine del ciclo di scarico.

## Individuazione e soluzione dei problemi

In caso di errore, sul display viene visualizzato "Err" e il relativo codice dell'errore. A questo punto lo strumento risponde solo al tasto Enter. Quando viene premuto Enter lo strumento cerca di riavviarsi. Viene anche eseguito automaticamente un ciclo di riferimento.

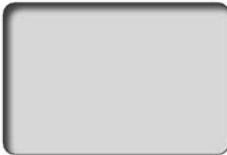
Problema	Codice errore	Possibile causa	Soluzione
Lo strumento non risponde		Accumulatore scarico o difettoso	Ricaricare l'accumulatore per almeno 5 minuti senza usare lo strumento, poi riprendere il lavoro con alimentatore inserito fino alla completa ricarica, eventualmente sostituire l'accumulatore
		Componenti elettronici guasti	Inviare lo strumento alla riparazione
Lo strumento non risponde		Componenti elettronici guasti	Inviare lo strumento alla riparazione
Lo strumento non risponde		Errore imprevisto del programma	Premere il tasto Enter per resettare, lo strumento viene reinizializzato
Lo strumento non risponde		Manca l'accumulatore	Inserire l'accumulatore
		Accumulatore guasto	Sostituire l'accumulatore
		Componenti elettronici guasti	Inviare lo strumento alla riparazione
Il puntale gocciola/ lo strumento perde o c'è un errore sul volume	—	Puntale non adatto	Usare solo puntali di qualità
		Il puntale non è inserito saldamente	Inserire a fondo il puntale/ o un altro adattatore
		Pistoni, gambo o la guarnizione è sporca o danneggiata	Pulire lo strumento/ sostituire la guarnizione. Ingrassare il pistone.
Nessuna indicazione sul display		Scarica elettrostatica	Rimuovere l'accumulatore e reinserirlo
		Componenti elettronici guasti	Inviare lo strumento alla riparazione

# Dati per l'ordinazione · Accessori · Parti di ricambio

## Transferpette® electronic

Volume	0,5-10 µl	2-20 µl	10-200 µl	50-1000 µl	250-5000 µl
<b>con alimentatore (110-240V/50-60 Hz)</b>	Codice	Codice	Codice	Codice	Codice
per Europa (continentale)	7052 99	7053 00	7053 03	7053 06	7053 07
per UK/Irlanda	7053 09	7053 10	7053 13	7053 16	7053 17
per USA/Giappone	7053 19	7053 20	7053 23	7053 26	7053 27
per Australia	7053 29	7053 30	7053 33	7053 36	7053 37
<b>senza alimentatore</b>	7053 39	7053 40	7053 43	7053 46	7053 47

## Alimentatore (110-240V/50-60 Hz)

	Codice
per l'Europa (continentale)	7053 50
per UK/Irlanda	7053 51
per USA/Giappone	7053 52
per Australia	7053 53

## Supporto per 3 strumenti con alimentatore per 3 Transferpette® electronic fino a 1000 µl

con alimentatore (110-240V/50-60 Hz)	Codice
per l'Europa (continentale)	7053 90
per UK/Irlanda	7053 91
per USA/Giappone	7053 92
per Australia	7053 93

## Accumulatore di ricambio

per Transferpette® electronic

Codice	7055 00
--------	---------

## Grasso al silicone

per Transferpette® electronic fino a 1000 µl

Codice	7055 02
--------	---------

## Grasso al silicone

per Transferpette® electronic 250 - 5000 µl

Codice	7036 77
--------	---------

## Puntali di qualità per pipette di BRAND, non sterili, PP

Volume	Confezione da	Codice
<b>pezzi sciolti</b>		
0,1 - 20 µl	2000	7320 02
0,5 - 20 µl	2000	7320 04
1 - 50 µl	2000	7320 06
2 - 200 µl	1000	7320 08
50 - 1000 µl	1000	7320 12
5 ml	200	7025 95
5 ml	1000	7026 00
<b>5 ml Tip-Box</b>	1 Box da 28	7026 05

## PLT unit

strumento per prove di tenuta di pipetta

Codice	7039 70
--------	---------

## Filtro per Transferpette® electronic

5 ml, confezione da 25

Codice	7046 52
--------	---------



**Parti di ricambio per Transferpette® electronic fino a 1000 µl**

Forma e dimensioni delle parti di ricambio dipendono dal rispettivo volume nominale. (fig. Parti di ricambio per Transferpette® electronic 10-200 µl.)

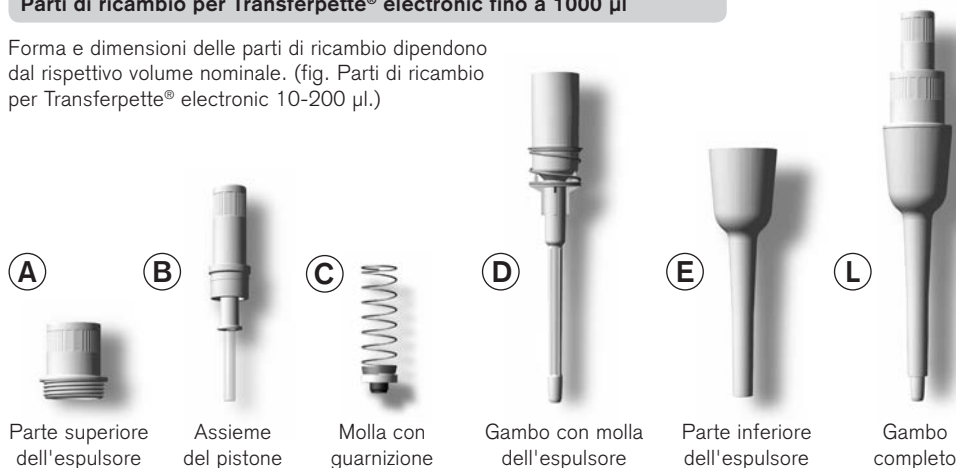

Parte superiore dell'espulsore

Assieme del pistone

Molla con guarnizione

Gambo con molla dell'espulsore

Parte inferiore dell'espulsore

Gambo completo

Volume	A	B	C	D	E	L
0,5 - 10 µl	7055 10	7055 18	-	7055 38	7055 48	7055 28
2 - 20 µl	7055 10	7055 20	7055 30	7055 39	7055 50	7055 29
10 - 200 µl	7055 10	7055 22	7055 32	7055 37	7055 53	7055 46
50 - 1000 µl	7055 10	7055 24	7055 34	7055 41	7055 55	7055 47

**Parti di ricambio Transferpette® electronic 250-5000 µl**



Parte superiore dell'espulsore

Parte inferiore dell'espulsore

Assieme del pistone

Parte inferiore del gambo

**Accessori per Transferpette® electronic 10-200 µl e 50-1000 µl**

Gli adattatori inseribili (distanziatori) (F) e i gambi della pipetta (K) con cono flessibile per l'inserimento del puntale assicurano una precisione di montaggio ottimale e una forza di espulsione molto ridotta con la maggior parte dei comuni puntali per pipetta.

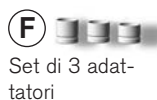

Set di 3 adattatori



Gambo della pipetta (completo)

Volume	G + G'	H	I
250 - 5000 µl	7299	7055 26	7032 47

Volume	F	K
10 - 200 µl	7055 60	7055 43
50 - 1000 µl	7055 62	7055 45

### Invio al servizio riparazioni

**Attenzione!** La legge vieta il trasporto di merci pericolose senza autorizzazione.

- Perciò: pulire e decontaminare accuratamente lo strumento!
- Allegare al reso una descrizione precisa del tipo di problema e dei fluidi utilizzati. Se non si indicano i fluidi utilizzati, l'apparecchio non può essere riparato.
- La restituzione avviene a rischio e spese del mittente.

### Fuori di Stati Uniti e del Canada:

- Compilare la 'Dichiarazione di assenza di rischi per la salute' ed inviarla con lo strumento al distributore o al produttore. I moduli possono essere richiesti al distributore o al produttore, oppure si possono scaricare dal sito [www.brand.de](http://www.brand.de).

### Dentro di Stati Uniti e del Canada:

- Si invita a chiarire i requisiti per la restituzione con BrandTech Scientific, Inc. prima di inviare lo strumento al servizio di assistenza.
- Inviare solo strumenti puliti e decontaminati all'indirizzo ricevuto insieme al numero di reso. Applicare il numero di reso bene in vista sull'esterno del pacco.

### Indirizzi di contatto

#### **BRAND GMBH + CO KG**

Otto-Schott-Straße 25  
97877 Wertheim (Germany)  
Tel.: +49 9342 808-0  
Fax: +49 9342 808-98000  
E-Mail: [info@brand.de](mailto:info@brand.de)  
[www.brand.de](http://www.brand.de)

#### **Stati Uniti e Canada:**

BrandTech® Scientific, Inc.  
11 Bokum Road  
Essex, CT 06426-1506 (USA)  
Tel.: +1-860-767 2562  
Fax: +1-860-767 2563  
[www.brandtech.com](http://www.brandtech.com)

#### **India:**

BRAND Scientific Equipment Pvt. Ltd.  
303, 3rd Floor, 'C' Wing, Delphi  
Hiranandani Business Park, Powai  
Mumbai - 400 076 (India)  
Tel.: +91 22 42957790  
Fax: +91 22 42957791  
E-Mail: [info@brand.co.in](mailto:info@brand.co.in)  
[www.brand.co.in](http://www.brand.co.in)

#### **Cina:**

BRAND (Shanghai) Trading Co., Ltd.  
Guangqi Culture Plaza  
Room 506, Building B  
No. 2899, Xietu Road  
Shanghai 200030 (P.R. China)  
Tel.: +86 21 6422 2318  
Fax: +86 21 6422 2268  
E-Mail: [info@brand.cn.com](mailto:info@brand.cn.com)  
[www.brand.cn.com](http://www.brand.cn.com)

### Servizio Calibrazione

Le norme ISO 9001 e GLP prevedono la verifica periodica degli strumenti volumetrici. Consigliamo una verifica del volume ogni 3-12 mesi. Il ciclo delle verifiche dipende dalle esigenze individuali. In caso di uso frequente o di liquidi aggressivi sono opportune verifiche più frequenti. Le istruzioni dettagliate per la verifica possono essere scaricate da [www.brand.de](http://www.brand.de) o [www.brandtech.com](http://www.brandtech.com).

Inoltre, BRAND vi offre la possibilità di far tarare i vostri strumenti dal nostro Servizio calibrazione o dal Laboratorio DAkKS BRAND.

Inviateci semplicemente i vostri strumenti con le indicazioni del tipo di taratura richiesta. Dopo pochi giorni riceverete gli strumenti accompagnati da un certificato di prova (taratura di fabbrica) o da un certificato di taratura DAkKS. Per maggiori informazioni rivolgersi al proprio rivenditore specializzato o direttamente alla BRAND. La documentazione per l'ordinazione può essere scaricata dal sito [www.brand.de](http://www.brand.de) (documentazione tecnica).

## Garanzia

Non ci assumiamo alcuna responsabilità per le conseguenze di manipolazione, uso, manutenzione e impiego non corretti, o per riparazioni non autorizzate dello strumento o per le conseguenze del normale consumo, in particolare dei componenti soggetti ad usura, come ad esempio pistoni, guarnizioni e valvole, e in caso di rottura del vetro. Lo stesso vale per la mancata osservanza delle istruzioni per l'uso. In particolare non ci assumiamo alcuna responsabilità per danni derivanti da un ulteriore smontaggio dello strumento, al di là di quello previsto nelle istruzioni per l'uso, o se vengono montati accessori o parti di ricambio non originali.

Stati Uniti e Canada:

Per informazioni sulla garanzia consultare il sito [www.brandtech.com](http://www.brandtech.com).

## Smaltimento

---

Il simbolo accanto segnala che alla fine della loro vita utile le batterie/accumulatori e le apparecchiature elettroniche devono essere smaltite separatamente dai rifiuti domestici (rifiuti urbani misti).

- Gli strumenti elettronici devono essere smaltiti secondo quanto prescritto dalla direttiva del parlamento europeo 2002/96/CE e del consiglio del 27 gennaio 2003 e dalla normativa nazionale vigente in materia di smaltimento di rifiuti di apparecchiature elettriche ed elettroniche.



- Le batterie/accumulatori contengono sostanze che possono avere effetti nocivi per l'ambiente e per la salute delle persone. Devono essere smaltiti secondo quanto prescritto dalla direttiva del parlamento europeo 2006/66/CE e del consiglio del 06 settembre 2006 e dalla normativa nazionale vigente in materia di smaltimento di rifiuti di batterie e accumulatori. Smaltire solo batterie e accumulatori completamente scarichi.

### Attenzione!

Non cortocircuitare batterie e l'accumulatore per scaricarlo!

Salvo modifiche tecniche, errori ed omissioni.

	页码
安全说明	174
功能与使用限制	175
禁止操作	175
<b>操作元件</b>	<b>176</b>
第一步	177
设定体积	178
设定吸液与排液速度	179
正确移液	180
移液程序	181
移液 (PIP 模式)	182
样品混合(PIPMix模式)	184
反相移液(revPIP模式)	186
电泳上样(GEL模式)	188
连续分液(DISP模式)	190
检查体积	192
准确度表	193
<b>易校准 (调整)</b>	<b>194</b>
灭菌	196
参考运行 ( rEF)	196
保养与清洁	197
电池充电与更换电池	199
电池再生功能	200
故障诊断	201
订购信息·附件·零备件	202
维修和·联系地址	204
校准服务	205
担保信息·丢弃	206

# 安全说明

该设备可能与有害的物质、操作和设备一起使用。本手册不可能提示这些应用中所有的潜在安全风险。用户有责任在使用前咨询并建立恰当的安全与健康规程，并决定规章限制的适用性。

## 请仔细阅读下列说明！

1. 所有使用者在使用该设备之前必须阅读并理解本操作手册，并在使用过程中遵守这些说明。
2. 遵循有害防护与安全指导的通用规章；比如，穿着防护服，佩戴防护镜与手套。  
当操作具有感染性或者有危害的样品时，须遵守所有适用规章并采取预防措施。
3. 请遵守试剂供应商提供的所有安全注意事项。
4. 绝不可以有爆炸危险的环境中使用本仪器。不可移取易燃液体。
5. 本仪器仅可用于液体移取，所移液体需严格符合“禁止操作”与“操作限制”的规定（参见第175页）。如有疑问，请联系厂方或者供应商。
6. 请始终以对用户及他人均安全的方式进行操作。仅将样品分配至合适的容器内，防止飞溅。
7. 操作危险样品时请避免接触吸头吸嘴。
8. 操作时请勿过度用力。
9. 请仅使用原厂配件。切勿试图对本仪器进行任何技术改造。不要对本仪器进行超过操作手册描述范围的拆卸。
10. 使用前请检查仪器有无可见损伤。如果仪器在操作时有潜在的故障迹象（比如，活塞移动困难、泄漏），请立即停止移液。咨询本手册的“故障诊断”（参见201页），有必要的请联系供应商。
11. 请勿使用其他不可充电或者可充电电池替换原装电池。
12. 为镍氢电池充电，请仅适用原装AC电源适配器。
13. AC电源适配器须防止受潮。仅可使用在本设备上。
14. 仅可在电池完全放电后对电池进行处置。请遵守当地相关处置规定。

## 警告！

该仪器或电池使用不当（短路、机械损坏、过热，错误的AC电源适配器等）在极端情况下可能会导致电池爆炸。

Transferpette® electronic 电子移液器是一款微处理器控制、电池驱动活塞的移液器，采用空气活塞式原理，用于移取一般密度和粘度的水相溶液。

在正确操作过程中，样品仅与吸头接触，不会与 Transferpette® electronic 接触。

### 使用限制

Transferpette®-8/-12 electronic 设计用于在下列使用限制范围内的移液操作：

- 设备和溶液的温度应为 15 °C~40 °C (59 °F ~104 °F)。若使用的温度不在此范围内，请咨询供应商。
- 蒸汽压小于 500 mbar
- 黏度：260 mPa s (260 cps)

### 禁止操作

用户有责任确认该设备与拓展应用的兼容性。

请勿将该装置用于会与聚丙烯 (PP：吸头与吸头锥) 或聚碳酸酯/聚对苯二甲酸丁酯 (PC / PBT：握柄) 反应的液体。防止接触反应性蒸汽 (腐蚀危险)。

握柄部位不可灭菌。

### 操作限制

粘稠或高粘性的液体可能会导致体积失准。移液的准确度同样可能受到温度的影响 (当液体温度与室温的温差大于  $\pm 5$  °C / 41 °F)。

### 电池和AC电源适配器规格

#### 电池

镍氢电池，带三块AAA柱状独立电池。  
3.6 V, 700 mAh

#### AC电源适配器

输出电压 6.5 V DC, 200 mA

# 操作元件

Transferpette® electronic电子移液器是一款微处理器控制、电池驱动活塞的多通道移液器，根据人体工程学进行优化，简便易用。



Transferpette® electronic 采用人体工程学设计，操作舒适。指托高度可通过一颗螺丝调节，从而允许对手的姿势进行微调，使操作功能按钮更轻松。

## 按键功能

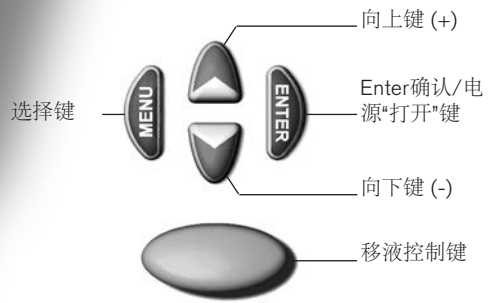

\*) 按ENTER确认键可激活设备。按下下面的移液控制键之后，即可进行移液操作。  
Transferpette® electronic 在 10 分钟无操作情况下将自动关机 (Auto-Power-Off)。



### 核对包装内容

确认您的包装内包含：Transferpette® electronic 电子移液器，电池，AC电源适配器带充电线，硅油，本操作手册与一小包样品吸头。

### 第一次使用 Transferpette® electronic

#### 1. 插入电池

- a) 打开电池仓盖。
- b) 确保电池上的插头与移液器的插座牢固连接。放入电池。
- c) 盖上电池仓盖。



#### 2. 激活设备

插入电池后，Transferpette® electronic会自动要求进行参考运行。按下移液控制键之后，进行参考运行，然后可以进行移液操作。

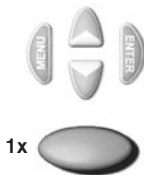

显示屏显示标准出厂设置（移液模式/PIP）和标称量程（例如 200.0 µl）。默认的吸液和排液速度为最大值。量程和速度的调节将在下面内容中描述。

移液模式

电量提示

向上箭头，  
代表吸液

量程设定

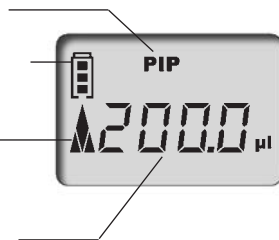

# 设定体积

Transferpette® electronic 的出厂量程设置为标称量程，可以快速方便地进行更改。

操作步骤	操作方法	操作按钮	屏幕显示
1. 激活量程设定	按任意一个箭头键，激活量程选择功能。“VOL”图标闪烁。		
2. 改变体积	减少体积 按向下箭头键 (-) 减少体积。 按住箭头键不放可以加快更改速度。“VOL”图标继续闪烁。		
	增加体积 按向上箭头键 (+) 增加体积。 按住箭头键不放可以加快更改速度。“VOL”图标继续闪烁。		
3. 确认体积设定	按 ENTER 确认键。显示屏将显示新的体积，在这里，PIP 模式下为 102.8 µl。		

## 重要提示：

按 MENU 菜单键可取消任何步骤！接着显示屏进入下一设置或返回至初始屏幕(取决于实际进行的选择)。

吸液和排液速度可单独调节。调出菜单之后，将显示上次速度的设置。有五个速度级别可供选择。

操作步骤	操作方法	操作按钮	屏幕显示
<b>设定吸液速度</b>			
1. 调出菜单	按 MENU 菜单键一次，可调出吸液速度菜单。“Speed”速度图标闪烁。	1x 	
2. 更改吸液速度	按箭头键 (+/-) 选择需要的速度 (这个例子里选的是，第五档)。“Speed”速度图标继续闪烁。		
3. 确认速度设置	按 ENTER 确认键。显示返回当前模式 (这个例子中为标准 PIP 移液模式)。	 1x	
<b>设定排液速度</b>			
1. 调出菜单	按 MENU 菜单键两次，可调出排液速度菜单。“Speed”速度图标闪烁。	2x 	
2. 更改排液速度	按箭头键 (+/-) 选择需要的速度 (这个例子里选的是，第二档)。“Speed”速度图标继续闪烁。		
3. 确认速度设置	按 ENTER 确认键。显示返回当前模式 (这个例子中为标准 PIP 移液模式)。	 1x	

Transferpette® electronic 的出厂量程设置为标称量程，可以快速方便地进行更改。参见第 178 页。

### 在标准移液模式下快速启动

#### 1. 安装吸头

请根据量程范围或颜色标识使用正确规格的吸头。确保牢固安装吸头。当使用具有弹性吸头锥的下半支机身时，如有必要，请更换吸头脱卸套管调节圈。

吸头为一次性物品！

#### 2. 吸取液体

垂直握持移液器并将吸头浸入液体 2-3mm。



按移液控制键将液体吸入吸头。显示屏上的向上的箭头，指示正处于吸液状态。



**提示：** 将吸头继续保持浸入液体约 1s，以防止吸入空气。

#### 3. 排出液体

吸液之后，显示屏上的箭头向下，指示进入排液状态。

手握移液器呈 30-45° 的角度，将吸头贴在容器壁上。

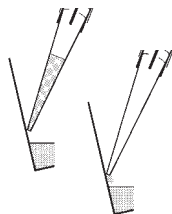

再次按移液控制键将液体完全排出，吹出为自动执行。将吸头贴在容器壁上擦去残液。



#### 4. 退除吸头

手持移液器，将多道移液仓悬空置于合适的处置容器上方，然后按吸头脱卸键。



吸头脱卸键



**提示：**

依据 ISO 8655，在实际进行移液过程之前，应用样品液体润洗一次吸头。

- 1. 标准移液**  
**PIP**模式 182  
标准程序。移液器吸取之前设定体积的液体，然后排出液体。
  
- 2. 样品混合**  
**PIPMix**模式 184  
该程序可完成样品混合操作。反复吸取和排出样品。
  
- 3. 反相移液**  
**revPIP**模式 186  
专为移取高黏度、高蒸汽压或易发泡液体所设计的程序。
  
- 4. 凝胶电泳上样**  
**GEL**模式 188  
该程序模式可用于凝胶电泳上样。以较高的可调速度吸取预定义体积的样品，然后缓慢排出样品。
  
- 5. 连续分液**  
**DISP**模式 190  
连续等分移液的程序。可将所吸取的液体分次排出。

Transferpette® electronic 1000 µl 与 5000 µl 不提供 GEL 模式。

标准程序。移液器吸取之前设定体积的液体，然后排出液体。  
体积和速度调整参见第 178 和 179 页。

操作步骤	操作方法	操作按钮	屏幕显示
1. 调出菜单	按MENU菜单键三次，可调出模式选择菜单。“Mode”模式图标闪烁。	3x 	
2. 选择 PIP模式	使用任意一个箭头键滚动模式菜单，直至“PIP”选项出现。“Mode”模式图标继续闪烁。		
3. 确认 PIP模式	按ENTER 确认键。 显示屏将显示“blo”吹出，指示进行吹出操作。	 1x	
4. 准备移液	按移液控制键，执行吹出动作（移液器在任何程序确认后都自动要求执行吹出，确保吸头中没有上轮操作的残液），活塞移动至起始位置。显示屏上的箭头显示向上（吸液）。	 1x	
5. 吸取液体	按移液控制键吸取液体。	 1x	

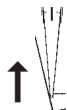

操作步骤	操作方法	操作按钮	屏幕显示
------	------	------	------

## 6. 排出液体

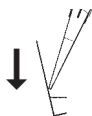

按移液控制键排出液体。显示屏上的箭头在吸取完液体后指示自动转为向下(排液)。



## 7. 吹出?

无需进行操作!  
在PIP模式下进行移液时,  
将自动执行吹出功能。



## 手动调出吹出功能

如有必要,可随时手动调出吹出功能。

## 1. 调出吹出功能

按ENTER(回车)键。显示屏将显示“blo”吹出。

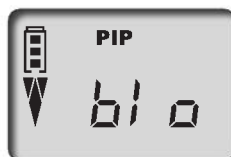

## 2. 进行吹出

按移液控制键进行吹出。执行完毕后显示屏将返回至选定移液模式的初始界面。



## 提示:

执行吹出时,移液器活塞将移动至最低位置。使用者必须确保安全排出所有残留液体。

若按住移液控制键不放,活塞将保持在最低位置,从而可避免意外吸入液体。释放此键,活塞将返回至起始位置。

该程序可完成样品混合操作。反复吸取和排出样品。  
体积和速度调整参见第178和179页。

操作步骤	操作方法	操作按钮	屏幕显示
1. 调出菜单	按 MENU 菜单键三次，可调出模式选择菜单。“Mode”模式图标闪烁。	3x 	
2. 选择 PIPmix模式	使用任意一个箭头键滚动模式菜单，直至“PIP”选项出现。“Mode”模式图标继续闪烁。		
3. 确认 PIPmix模式	按 ENTER 确认键。显示屏将显示“blo”吹出，指示进行吹出操作。	 1x	
4. 准备移液	按移液控制键，执行吹出动作（移液器在任何程序确认后都自动要求执行吹出，确保吸头中没有上轮操作的残液），活塞移动至起始位置。显示屏上的箭头显示向上（吸液）。	 1x	
5. 吸取液体	按移液控制键吸取液体。	 1x	

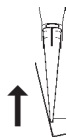







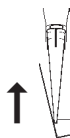

操作步骤	操作方法	操作按钮	屏幕显示
<p>6. 在 PIPmix 模式下排液</p> 	<p>按住移液控制键不放，即可吸取或排出液体。显示屏显示向上箭头表示吸液，向下箭头表示排液，并显示吸排液的轮数。</p>	 <p>按住移液控制键不放</p>	
<p>7. 结束移液</p>	<p>按移液控制键，将排出液体并启动吹出功能。 排出残留液体（吹出）之后，显示将返回至起始界面。</p>	 <p>1x</p>	

**提示：** 显示屏可显示的吸排液的轮数最多为19轮。

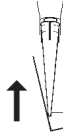
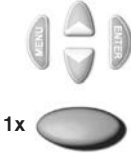
专为移取高黏度、高蒸汽压或易发泡液体所设计的程序。  
体积和速度调整参见第 178 和 179 页。

操作步骤	操作方法	操作按钮	屏幕显示
1. 调出菜单	按 MENU 菜单键三次，可调出模式选择菜单。“Mode”模式图标闪烁。	3x 	
2. 选择 revPIP模式	使用任意一个箭头键滚动模式菜单，直至“revPIP”选项出现。“Mode”模式图标继续闪烁。		
3. 确认 revPIP模式	按 ENTER 确认键。显示屏将显示“blo”吹出，指示进行吹出操作。	 1x	
4. 准备移液	按移液控制键，执行吹出动作（移液器在任何程序确认后都自动要求执行吹出，确保吸头中没有上轮操作的残液），活塞移动至起始位置。显示屏上的箭头显示向上（吸液）。	 1x	
5. 吸取液体	按移液控制键吸取液体。所吸取的液体体积将会比设定体积稍多。	 1x	
6. 在 revPIP模式下 排水	如需排出设定量的液体，按移液控制键。显示屏上的箭头在吸取完液体后指示自动转为向下（排水）。部分残余液体将留在吸头内。	 1x	

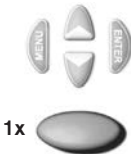

操作步骤	操作方法	操作按钮	屏幕显示
<p>7. 在 revPIP模式下重复吸液</p> 	<p>再次按移液控制键，设定体积的液体将被吸入吸头。之后再次按移液控制键，此体积的液体将被再次排出，以此循环…</p>		
<p>8. 启动吹出功能</p>	<p>在最后一次移液操作之后按 ENTER (回车) 键。显示屏将显示“blo”吹出。</p>		
	<p>按移液控制键执行吹出。残留液体被排出。</p>		
<p>9. 结束移液</p>	<p>排出残留液体（吹出）之后，显示将返回至起始界面。</p>		

该程序模式可用于凝胶电泳上样。以较高的可调速度吸取预定义体积的样品，然后缓慢排出样品。体积和速度调整参见第178和179页。

操作步骤	操作方法	操作按钮	屏幕显示
1. 调出菜单	按 MENU 菜单键三次，可调出模式选择菜单。“Mode”模式图标闪烁。	3x	
2. 选择 GEL 模式	使用任意一个箭头键滚动模式菜单，直至“GEL”选项出现。“Mode”模式图标继续闪烁。		
3. 确认 GEL 模式	按 ENTER 确认键。显示屏将显示“blo”吹出，指示进行吹出操作。	1x	
4. 准备移液	按移液控制键，执行吹出动作（移液器在任何程序确认后都自动要求执行吹出，确保吸头中没有上轮操作的残液），活塞移动至起始位置。显示屏上的箭头显示向上（吸液）。	1x	
5. 吸取液体	按移液控制键。设定体积的液体将被吸入吸头。	1x	
			吸取超量的液体 如需吸取比设定体积多的液体（最多为标称量程的110%），按住移液控制键，直至吸取了所需体积的液体。显示屏在吸液时显示一个菱形图标。

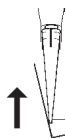

按住移液控制键不放

操作步骤	操作方法	操作按钮	屏幕显示
6. 在 GEL 模式下排液	按移液控制键排液。显示屏此时显示一个菱形图标。液体被非常缓慢地排出。	 1x 	
	中断排液 如需中断排液，再次按移液控制键。显示屏显示已排出体积。	 1x 	
7. 启动吹出功能	在最后一次移液操作之后按 ENTER 确认键。显示屏将显示“blo”吹出。	 1x 	
	按移液控制键执行吹出。残留液体被排出。	 1x 	
8. 结束移液	排出残留液体（吹出）之后，显示将返回至起始界面。		

**提示：**

在 GEL 模式下，排液速度非常缓慢，以防止样品产生涡流。为确保达到最佳的凝胶上样效果，GEL 模式的排液速度为固定值。此速度远远小于 1 档速度设定，并且不可单独进行选择。

连续等分移液的程序。可将所吸取的液体分次排出。  
速度调整参见第 179 页。

操作步骤	操作方法	操作按钮	屏幕显示
1. 调出菜单	按 MENU 菜单键三次, 可调出模式选择菜单。“Mode”模式图标闪烁。	3x 	
2. 选择 DISP模式	使用任意一个箭头键滚动模式菜单, 直至“DISP”选项出现。“Mode”模式图标继续闪烁。		
3. 确认 DISP模式	按 ENTER 确认键。显示屏将显示“blo”吹出, 指示进行吹出操作。	 1x	
4. 准备分液	按移液控制键, 执行吹出动作 (移液器在任何程序确认后都自动要求执行吹出, 确保吸头中没有上轮操作的残液), 活塞移动至起始位置。显示屏上的箭头显示向上(吸液)。	 1x	
5. 设定单次分液体积	按箭头键 (+/-) 设定体积。按住箭头键不放可以加快更改速度。“VOL”闪烁。		
6. 确认单次分液体积	按 ENTER 确认键。显示屏将显示单次分液体积设置和最大排液次数。“Steps”次数图标闪烁。	 1x	

操作步骤	操作方法	操作按钮	屏幕显示
7. 设定分液次数	按箭头键 (+/-) 设定分液次数。“Steps”次数图标继续闪烁。		
8. 确认分液次数	按 ENTER 确认键。显示屏将显示设定的分液次数。		
9. 吸取液体	按移液控制键吸取液体。		
10. 连续分配液体	每按一次移液控制键，将执行一次分液。显示屏上的箭头向下（排液）。显示屏显示剩余的分液次数。		
11. 启动吹出功能	在最后一次移液操作之后按 ENTER 确认键。显示屏将显示“blo”吹出。 按移液控制键执行吹出。残留液体被排出。(也可参见 189 页)		
12. 结束移液	排出残留液体（吹出）之后，显示将返回至起始界面。		

# 检查体积

根据使用情况，建议每3至12个月对移液器进行一次校准。根据具体情况可对检查周期时间进行调整。

依据DIN EN ISO 8655 第6部分，使用重力法按下列步骤对移液器进行测试。

## 1. 设定标称量程

将体积设定为移液器的最大量程。  
操作步骤参见第178页。

## 2. 调整移液器状态

在测试之前，安装一个移液器吸头，并用测试液体（蒸馏水）进行五次吸液和排液操作。然后弃置该吸头。

## 3. 执行测试

- 安装一个新的吸头，并用测试液体吸液一次润洗吸头。
- 吸取测试液体，并将其移取至称量容器内。
- 用分析天平称量所移取液体。  
请遵守天平制造商的操作说明。
- 在考虑温度条件的情况下计算体积。
- 建议每个通道在三个量程段（标称量程的100%、50%、10%体积）进行3-10次移液和称量操作，以便进行统计分析。

### 计算（标称量程）

$x_i$  = 称量结果  
 $n$  = 称量次数

$Z$  = 校正因子  
(例如 1.0029  $\mu\text{l}/\text{mg}$  (20 °C, 1013 hPa))

平均值  $\bar{x} = \frac{\sum x_i}{n}$

平均体积  $\bar{V} = \bar{x} \cdot Z$

### 准确度\*

$$R\% = \frac{\bar{V} - V_0}{V_0} \cdot 100$$

$V_0$  = 标称量程

### 标准偏差

$$s = Z \cdot \sqrt{\frac{\sum (x_i - \bar{x})^2}{n - 1}}$$

### 偏差系数\*

$$VK\% = \frac{100 s}{\bar{V}}$$

\*) = 计算准确度 (A%) 和偏差系数 (CV%)  
A %和CV %的计算依据统计学公式。



根据DIN EN ISO 8655 要求。标称（额定）量程（即仪器的最大量程）与分段量程，使用蒸馏水在 20 °C/68 °F，平顺稳定地操作测得的误差极限。



20 °C  
Ex

## Transferpette® electronic 精度误差范围

量程范围 µl	体积 µl	A* ≤ ± %	CV* ≤ %	增量 (分刻度) µl	建议吸头类型 µl
0.5 - 10	10	1.0	0.4	0.01	0.5 - 20
	5	1.5	0.8		
	1	5.0	2.0		
2 - 20	20	1.0	0.4	0.02	0.5 - 20
	10	1.5	0.8		
	2	5.0	2.5		
10 - 200	200	0.8	0.2	0.2	2 - 200
	100	1.2	0.3		
	20	4.0	0.6		
50 - 1000	1000	0.6	0.2	1.0	50 - 1000
	500	1.0	0.3		
	100	3.0	0.6		
250 - 5000	5000	0.6	0.2	5.0	500 - 5000
	2500	1.0	0.3		
	500	3.0	0.6		

\* A = 准确度, CV = 偏差系数

### 提示:

本仪器依照德国测量和校准法以及测量和校准条例进行标记:

**DE-M** 19

字符串 DE-M (DE 代表德国), 用一个矩形框住, 以及设置该标记年份的最后两个数字 (此处为: 2019 年)。

### 提示:

测试指南 (SOP) 和 EASYCAL™ 4.0 校准软件的试用版可在 [www.brand.de](http://www.brand.de) 上下载。

## 校准模式，“CAL”

### 调整

在标准移液 (PIP) 模式下，将移液器设定为标称量程 (例如标称量程为 100 µl 的移液器设置为 200 µl) 或者特定的测试体积。操作步骤见第 178 与 182 页。假设：在标称量程时实测体积为 201.3 µl。



### 操作步骤

### 操作方法

### 操作按钮

### 屏幕显示

#### 1. 调出 CAL 模式

按住 MENU 菜单键 (> 3 s)，直至“CAL”图标出现。显示屏显示“off”关闭字样。“CAL”图标闪烁。



#### 2. 激活 CAL 模式

按任意一个箭头键，激活 CAL 模式。显示由“off”关闭变为“on”开启。“CAL”图标继续闪烁。

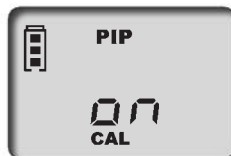

#### 3. 确认 CAL 模式

按 ENTER 确认键。显示设定体积界面。“CAL”图标继续闪烁。



#### 4. 设定体积

按箭头键 (+/-) 调至实测体积。“CAL”继续闪烁。



#### 5. 确认体积

按 ENTER 确认键。显示屏显示校准后的测试体积。“CAL”固定显示在下方表示移液器进行过调整。



## 恢复出厂默认设置

“CAL” 固定显示表示移液器进行过调整。



## 操作步骤

## 操作方法

## 操作按钮

## 屏幕显示

## 1. 调出 CAL 模式

按住 MENU 菜单键(> 3 s), 直至“CAL”图标出现。显示屏显示“ON”开启字样。“CAL”图标闪烁。

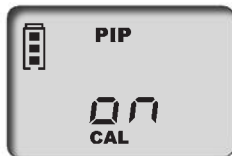
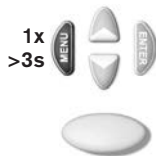

## 2. 关闭 CAL 模式

按任意一个箭头键。显示由“on”开启变为“off”关闭。“CAL”图标继续闪烁。



## 3. 恢复出厂默认设置

按 ENTER 确认键。CAL 图标消失。现在，移液器量程已恢复至出厂默认设置。



**重要提示:** 对 Transferpette® electronic 进行调整时, 进行了体积补偿, 这意味着移液器整个量程范围内的体积均发生了相同量的变化。建议在标称量程的 50 % 体积下进行调整。

**提示:** 该移液器设置为适用于水溶液, 但也可设定适合不同密度、粘度和温度的溶液。除 GEL 模式外, 可在任何模式下对 Transferpette® electronic 进行调整。

## 灭菌

依据 DIN EN 285, 可在 121 °C (250 °F)、2 bar (30 psi) 条件下对 Transferpette® electronic 的多道移液仓(P) (图中高亮部分) 进行至少 15 分钟的高温高压湿热灭菌。

**注意：** 握柄部分不可高温灭菌！

1. 退掉吸头。
2. 从握柄上旋下下半支机身。
3. 对整个多道移液仓（无需进一步拆卸）进行高温高压灭菌。
4. 等待多道移液仓完全冷却并干燥。
5. 将多道移液仓旋入手柄。
6. 执行参考运行 (rEF)。





**提示：** 灭菌效果须由使用者判断。  
采用真空灭菌最可靠。建议使用灭菌袋。

如果经常实行高压灭菌，为了确保更好的通畅性，需要使用随附的硅润滑脂润滑活塞和密封垫。

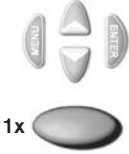

## 参考运行 (rEF)

每次将多道移液仓重新装上握柄之后，必须进行手动参考运行。参考运行可确保活塞牢固连接。

操作步骤	操作方法	操作按钮	屏幕显示
1. 调出rEF模式	同时按 MENU 菜单和 ENTER 确认键激活 rEF 模式。		
2. 执行参考运行	按移液控制键执行参考运行。可以听到运行的声音，指示该功能正在进行。		

**提示：** 参考运行之后，将自动返回上一程序的显示界面。

为确保功能正常，请定期保养和清洁 Transferpette® electronic 移液器。

### 保养

检查吸头锥是否损坏。

检查活塞和密封圈是否被污染或损坏。

对仪器的活塞密封性进行测试。我们推荐使用 BRAND 的移液器泄漏检测仪 PLT 进行测试。或者：进行此测试时，安装一个系头，并吸取样品。将仪器垂直握持，让样品在吸头内保持约 10 s。若在吸头吸嘴有液滴形成，请参见 201 页的故障诊断。

### 拆卸和清洗

1. 从握杆上拧下移液器下半支 (S)。
  2. 轻轻向下拉，断开移液器下半支与握柄的磁力连接。
  3. 从移液器下半支机身上旋下吸头脱卸套管上部 (A)。
  4. 将活塞套管 (D) 从吸头脱卸套管 (E) 拉出。
  5. 拧松活塞单元 (B)。
- 提示：** 活塞保持与活塞单元 (B) 连接。
6. 取下带弹簧的密封圈 (C)。
  7. 用温和的肥皂液或异丙醇清洁所示部件，然后用蒸馏水冲洗。
  8. 将所有部件晾干(最高温度 120 °C /248 °F)。
  9. 为活塞涂薄薄一层硅油。
  10. 待部件冷却至室温时，按与上述步骤相反的顺序重新组装部件。活塞单元和吸头脱卸套管的上部 (A、B) 只需拧至手感紧固即可。
  11. 执行参考运行 (rEF)。

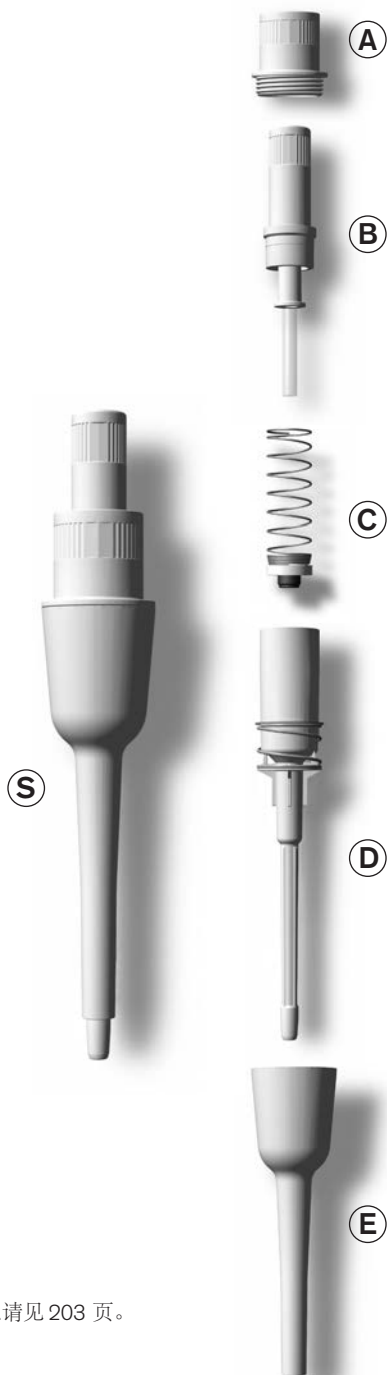

**提示：** 这里出现的所有配件，都可以单独订购。订购信息请见 203 页。

为确保功能正常，请定期保养和清洁 Transferpette® electronic 移液器。

### 保养

检查吸头锥是否损坏。

检查活塞和密封圈是否被污染或损坏。

对仪器的活塞密封性进行测试。我们推荐使用 BRAND 的移液器泄漏检测仪 PLT 进行测试。或者：进行此测试时，安装一个系头，并吸取样品。将仪器垂直握持，让样品在吸头内保持约 10 s。若在吸头吸嘴有液滴形成，请参见 201 页的故障诊断。

### 拆卸和清洗

1. 同时按下半支机身两侧的压扣 (J)，取下吸头脱卸套管 (G')。
2. 从握杆上拧下活塞套管 (H+I)。
3. 轻轻向下拉，断开移液器下半支与握柄的磁力连接。移去吸头脱卸套管的上部 (G)。
4. 从活塞套管 (I) 上旋开并取出活塞单元 (H)。
5. 从活塞单元上取下 O 形环密封圈，并进行清洗。

**提示：** 请勿进一步拆卸活塞单元 (H)！

6. 用温和的肥皂液或异丙醇清洗活塞单元 (H) 和活塞套管 (I)，然后用蒸馏水冲洗。
7. 将所有部件晾干 (最高温度 120 °C/ 248 °F) 并等待部件冷却。
8. 小心对 O 形密封圈内外侧进行润滑，并将其安装在活塞上。
9. 按与上述步骤相反的顺序重新组装各部件。
10. 执行参考运行 (rEF)。

**提示：** 这里出现的所有配件，都可以单独订购。订购信息请见 203 页。

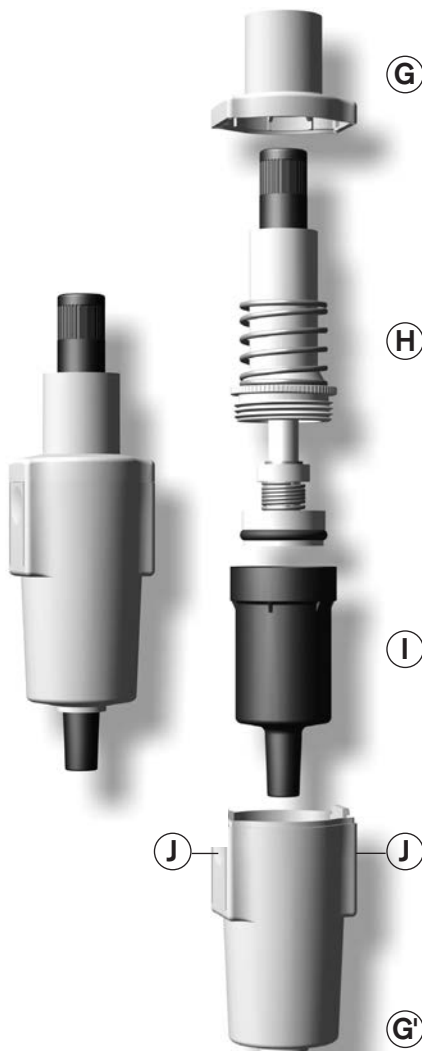

充满电的电池可连续使用约8小时 (所移取液体的粘度和密度接近于水)。

## 重要提示！

充电之前，请确保AC电源适配器与实验室的电压相符合。请勿在有爆炸风险的环境下充电。仅可在 Transferpette® electronic 内为电池充电。

## 电池充电

- 将AC电源适配器的充电插头插入Transferpette® electronic 顶部的插口；充电将自动开始。
- 充电过程中，电量指示进度条将从底部到顶部反复变化。电池充满电时，显示屏上的电量指示将停止运动。



## 充电过程中进行移液？

充电过程中，您可以继续使用 Transferpette® electronic。若电池完全放电，在达到安全操作需要的最小电量之前会有几分钟时间无法操作。

**提示：** 最后一次操作的设置储存在移液器的存储器内。即便电池完全放电或者更换电池之后，这些设置仍然保存着。

## 更换电池

- 打开电池仓盖。取出电池，将电池插头从插座中小心拔出。
- 将新电池上的插头与移液器的插座牢固连接。放入电池。
- 盖上并关闭电池仓盖。



长时间不用时，请取出电池。

## 电池充电与更换电池

### 插入电池后的显示

- a) 插入电池之后，电量指示为满格但外框闪烁，此时，移液器不识别充电状态。充电 3.5 小时之后 - 安全为电池充满电 - 电量指示图标框外框停止闪烁。



**提示：** 插入电池之后，充电时间始终应为 3.5 个小时！  
几次完全充电之后电池电量将达到最优。

## 电池再生功能

### (恢复功能)

为延长电池使用寿命并优化电池性能，Transferpette® electronic 具有再生功能（恢复功能）。该程序可对电池实现受控式完全放电和充电。为优化电池性能，应定期运行再生功能。

### 执行再生功能

- a) 将 AC 电源适配器的充电插头插入 Transferpette® electronic 顶部的插口。



- b) 按住向下箭头键并保持 > 3 s。  
放电过程中，电量指示进度条将从顶部到底部反复运动。



- c) 受控放电（最多 3 小时）之后，充电过程（3.5 小时）将自动启动。充电过程中，电量指示进度条将从底部到顶部反复运动。





### 中断再生功能

按任意按钮可结束此程序。移液器自动切换至标准移液（PIP）模式和标称量程，正常充电过程自动开始，参见 199 页。拔出 AC 电源适配器插头也会结束程序。放电周期结束时请勿中断再生功能。



若发生错误，显示屏将显示“Err”和错误编号。按 ENTER 确认键，移液器将做出反应。按 ENTER 确认键，移液器尝试重启。

因此，将自动请求执行参考运行

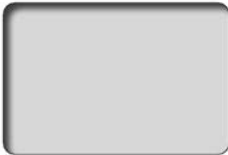
问题	错误提示	可能的原因	处理措施
移液器无反应		电池没电或者故障	在不进行操作的情况下为电池充电至少 5 分钟，然后仅可在插入充电器的情況下进行操作，直至电池充满电。如有必要，更换电池。
移液器无反应		电子元件故障	将仪器送修。
移液器无反应		不可预知的程序错误	按 ENTER 确认键确认错误。移液器将重新初始化。
移液器无反应		电池未插入 电池失效 电子元件故障	插入电池。 更换电池。 将仪器送修。
吸头滴漏/仪器不密封 或量程出错	—	吸头不合适 吸头安装不稳妥 活塞、吸头锥和密封圈 被污染或损坏。	请仅使用优质吸头 将吸头按紧/更换吸头脱卸套管调节圈 清洁移液器/更换密封圈。润滑活塞。
显示屏无显示		静电放电 电子元件故障	取出并再次插入电池。 将仪器送修。

## Transferpette® electronic

量程	0.5-10 µl	2-20 µl	10-200 µl	50-1000 µl	250-5000 µl
所带AC电源适配器	货号	货号	货号	货号	货号
适合欧洲/中国地区使用 (230V/50-60 Hz)	7052 99	7053 00	7053 03	7053 06	7053 07
适合英国/爱尔兰地区使用 (230V/50-60 Hz)	7053 09	7053 10	7053 13	7053 16	7053 17
适合美国/日本地区使用 (110V/50-60 Hz)	7053 19	7053 20	7053 23	7053 26	7053 27
适合澳大利亚地区使用 (240V/50-60 Hz)	7053 29	7053 30	7053 33	7053 36	7053 37
不带AC电源适配器	7053 39	7053 40	7053 43	7053 46	7053 47

### AC电源适配器

	货号
适合欧洲/中国地区使用 (230V/50-60 Hz)	7053 50
适合英国/爱尔兰地区使用 (230V/50-60 Hz)	7053 51
适合美国/日本地区使用 (110V/50-60 Hz)	7053 52
适合澳大利亚地区使用 (240V/50-60 Hz)	7053 53

### 电池

用于Transferpette® electronic

货号	7055 00
----	---------

### 硅胶

用于 Transferpette® electronic 1000 µl 以内的型号。

货号	7055 02
----	---------

### 硅胶

用于 Transferpette® electronic 250 - 5000 µl 。

货号	7036 77
----	---------

### PLT unit

移液器泄漏检测仪

货号	7039 70
----	---------

三头充电枪架, 适用于 3 支Transferpette® electronic 移液器同时充电 (最大量程至 1000 µl)

所带AC电源适配器	货号
适合欧洲/中国地区使用 (230V/50-60 Hz)	7053 90
适合英国/爱尔兰地区使用(230V/50-60 Hz)	7053 91
适合美国/日本地区使用(110V/50-60 Hz)	7053 92
适合澳大利亚地区使用(240V/50-60 Hz)	7053 93

BRAND高品质移液器吸头, 未灭菌, PP材质

量程	包装规格	货号
<b>散装</b>		
0.1 - 20 µl	2000	7320 02
0.5 - 20 µl	2000	7320 04
1 - 50 µl	2000	7320 06
2 - 200 µl	1000	7320 08
50 - 1000 µl	1000	7320 12
5 ml	200	7025 95
5 ml	1000	7026 00
<b>5 ml Tip-Box 吸头盒</b>	28 个/盒	7026 05

滤芯适用于所有 Transferpette® electronic

5 ml, 25个/包。

货号	7046 52
----	---------

量程至1000  $\mu\text{l}$  的Transferpette® electronic移液器的配件。

各仪器的部件会因标称量程不同而略有不同。(图中所示为Transferpette® electronic 10-200  $\mu\text{l}$  移液器的零备件)

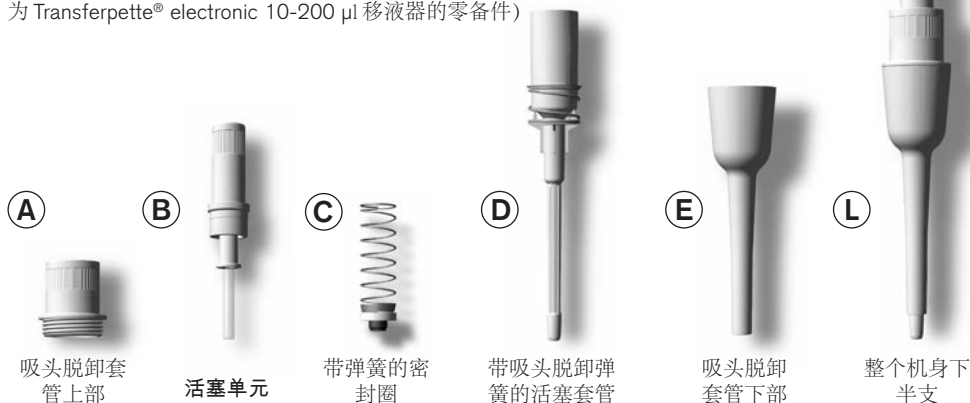

A 吸头脱卸套管上部

B 活塞单元

C 带弹簧的密封圈

D 带吸头脱卸弹簧的活塞套管

E 吸头脱卸套管下部

L 整个机身下半支

量程	A	B	C	D	E	L
0.5 - 10 $\mu\text{l}$	7055 10	7055 18	-	7055 38	7055 48	7055 28
2 - 20 $\mu\text{l}$	7055 10	7055 20	7055 30	7055 39	7055 50	7055 29
10 - 200 $\mu\text{l}$	7055 10	7055 22	7055 32	7055 37	7055 53	7055 46
50 - 1000 $\mu\text{l}$	7055 10	7055 24	7055 34	7055 41	7055 55	7055 47

Transferpette® electronic 250-5000  $\mu\text{l}$  移液器的配件。

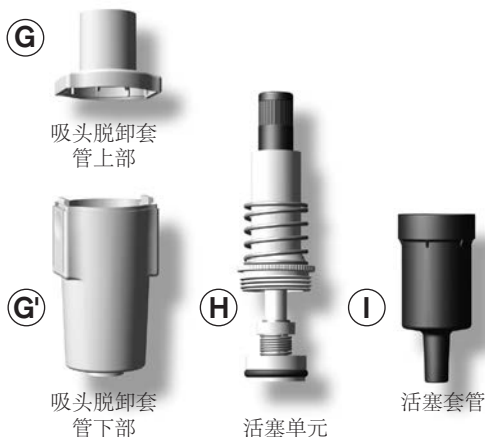

G 吸头脱卸套管上部

H 活塞单元

I 活塞套管

量程	G + G'	H	I
250 - 5000 $\mu\text{l}$	7299	7055 26	7032 47

Transferpette® electronic 10-200  $\mu\text{l}$  与 50-1000  $\mu\text{l}$  移液器的附件。

吸头脱卸套管调节圈 (F) 与带弹性吸头锥的下半支机身能够优化绝大多数移液器吸头的匹配精度并减少退吸头的耗力。

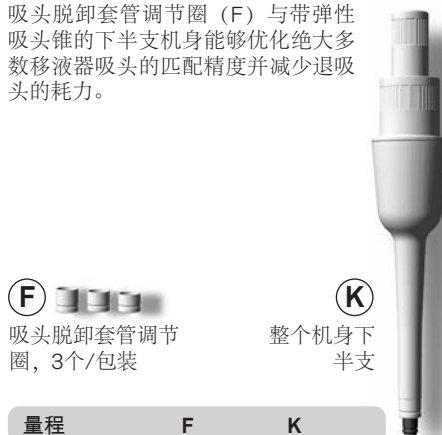

F 吸头脱卸套管调节圈, 3个/包装

K 整个机身下半支

量程	F	K
10 - 200 $\mu\text{l}$	7055 60	7055 43
50 - 1000 $\mu\text{l}$	7055 62	7055 45

### 仪器送修

**重要！** 未经同意运输有毒害的物品是违反联邦法律的。

- 请仔细完整地清洁仪器并去除污染。
- 必须附上故障与使用试剂的准确描述。  
若缺失使用试剂的相关信息，则不能对仪器进行维修。
- 运输费用与风险由发送者承担。

#### 除美国与加拿大外：

- 填写"无健康危害申明"并发给您的供应商或生产商。向您的供应商或生产商索要此表格。此表格可在 [www.brand.de](http://www.brand.de) 下载。

#### 在美国与加拿大：

- 在寄回仪器之前联系 BrandTech Scientific, Inc. 获取返修的授权号码。
- 仅接受寄回清洁的并去除污染的仪器，必须附上返修授权号码并粘贴在外包装显眼的位置，寄回返修授权号码对应的地址。

### 联系地址

#### **BRAND GMBH + CO KG**

Otto-Schott-Straße 25  
97877 Wertheim (Germany)  
Tel.: +49 9342 808-0  
Fax: +49 9342 808-98000  
E-Mail: [info@brand.de](mailto:info@brand.de)  
[www.brand.de](http://www.brand.de)

#### **USA and Canada:**

BrandTech® Scientific, Inc.  
11 Bokum Road  
Essex, CT 06426-1506 (USA)  
Tel.: +1-860-767 2562  
Fax: +1-860-767 2563  
[www.brandtech.com](http://www.brandtech.com)

#### **India:**

BRAND Scientific Equipment Pvt. Ltd.  
303, 3rd Floor, 'C' Wing, Delphi  
Hiranandani Business Park, Powai  
Mumbai - 400 076 (India)  
Tel.: +91 22 42957790  
Fax: +91 22 42957791  
E-Mail: [info@brand.co.in](mailto:info@brand.co.in)  
[www.brand.co.in](http://www.brand.co.in)

#### **中国：**

**普兰德 (上海) 贸易有限公司**  
上海市斜土路2899甲号光启文化广场  
B栋506室。200030  
电话: +86 21 6422 2318  
传真: +86 21 6422 2268  
电子邮件: [info@brand.cn.com](mailto:info@brand.cn.com)  
[www.brand.cn.com](http://www.brand.cn.com)

## 校准服务

ISO 9001 与 GLP 要求定期检查体积计量仪器。我们建议每隔 3-12 个月进行检查。时间间隔由使用的要求决定。如使用频繁或经常具有侵蚀性的试剂，间隔应该短一些。具体的测试指南可在 [www.brand.de](http://www.brand.de) 或 [www.brandtech.com](http://www.brandtech.com) 下载。

BRAND 也提供厂方的校准服务或 BRAND 具有的 DAkkS 校准服务。只需寄回需要校准的仪器与需要哪种校准服务的申请。您可在数日内重新获得经过校准的仪器与相应的厂方校准证书或者是 DAkkS 校准证书。需要了解更多信息，请联系您的经销商或者 BRAND。完整的订购信息可在 [www.brand.de](http://www.brand.de) 下载（参见技术文档）。

## 担保信息

我们不能承担由于不当拿取，使用，服务，操作或未授权的仪器维修产生的结果，我们同样不能承担由于正常易损件如活塞，密封垫圈，阀门的磨损或者玻璃破损而产生的结果，我们也不能承担由于不按照操作手册指导的操作而产生的结果。我们不能承担由于进行任何操作手册未描述的操作与使用或由于非原装配件的使用而产生的结果。

美国与加拿大  
担保信息请看 [www.brandtech.com](http://www.brandtech.com).

## 丢弃

---

右侧的标志代表电池与电子设备在寿命终结后须分别处置（不可与生活垃圾混合）。

- 根据欧洲议会 2002/96/EC 指令和 2003 年 1 月 27 日的废弃电子电气设备指令（WEEE），电子设备应依据国家有关处置法规进行处置。

- 电池含有对环境与人体健康有害的物质。因此根据根据欧洲议会 2006 年 9 月 6 日关于废弃电池的 2002/96/EC 指令，电池应依据国家有关处置法规进行处置。只有在完全放电之后才能丢弃。



### 警告!

不可短路电池进行放电!

如有技术变更，恕不另行通知。  
对于印刷或排版错误，我方不承担任何责任。

# DECLARATION OF CONFORMITY – China RoHS 2

BRAND GMBH + CO KG has made reasonable efforts to ensure that hazardous materials and substances may not be used in BRAND products.

In order to determine the concentration of hazardous substances in all homogeneous materials of the subassemblies, a "Product Conformity Assessment" (PCA) procedure was performed. As defined in GB/T 26572 the "Maximum Concentration Value" limits (MCV) apply to these restricted substances:

- Lead (Pb): 0.1%
- Mercury (Hg): 0.1%
- Cadmium (Cd): 0.01%
- Hexavalent chromium (Cr(+VI)): 0.1%
- Polybrominated biphenyls (PBB): 0.1%
- Polybrominated diphenyl ether (PBDE): 0.1%

## Environmental Friendly Use Period (EFUP)

EFUP defines the period in years during which the hazardous substances contained in electrical and electronic products will not leak or mutate under normal operating conditions. During normal use by the user such electrical and electronic products will not result in serious environmental pollution, cause serious bodily injury or damage to the user's assets.

The environmental Friendly Use Period for BRAND instruments is 40 years.



此表格是按照SJ/T 11364-2014中规定所制定的。

This table is created according to SJ/T 11364-2014.

MATERIAL CONTENT DECLARATION FOR BRAND PRODUCTS							
有毒有害物质或元素 Hazardous substances							
部件名称 Part name	铅 Pb	汞 Hg	镉 Cd	六价铬 Cr(+VI)	多溴联苯 PBB	多溴二苯醚 PBDE	环保期限标识 EFUP
包装 / Packaging	0	0	0	0	0	0	
塑料外壳 / 组件 Plastic housing / parts	0	0	0	0	0	0	
电池 / Battery	0	0	0	0	0	0	
玻璃 / Glass	0	0	0	0	0	0	
电子电气组件 Electrical and electronic parts	X	X	X	0	0	0	
金属外壳 / 组件 Metal housing / parts	X	0	0	0	0	0	
电机 / Motor	X	0	0	0	0	0	
配件 / Accessories	X	0	0	0	0	0	

**注释:** 此表格适用于所有产品。以上列出的元件或组件不一定都属于所附产品的组成。

**Note:** Table applies to all products. Some of the components or parts listed above may not be part of the enclosed product.

- O: 表示该有毒有害物质在该部件所有均质材料中的含量均在GB/T 26572规定的限量要求以下。  
O: Indicates that the above mentioned hazardous substance contained in all homogeneous materials of the part is below the required limit as defined in GB/T 26572.
- X: 表示该有毒有害物质至少在该部件某一均质材料中的含量超出GB/T 26572规定的限量要求。  
X: Indicates that the above mentioned hazardous substance contained in at least one of the homogeneous materials of this part is above the required limit as defined in GB/T 26572.

除上表所示信息外, 还需声明的是, 这些部件并非是有意图用铅 (Pb), 汞 (Hg), 镉 (Cd), 六价铬 (Cr(+VI)), 多溴联苯 (PBB) 或多溴二苯醚 (PBDE) 来制造的。

Apart from the disclosures in the above table, the subassemblies are not intentionally manufactured or formulated with lead (Pb), mercury (Hg), cadmium (Cd), hexavalent chromium (Cr+VI), polybrominated biphenyls (PBB), and polybrominated diphenyl ethers (PBDE).

Products manufactured by BRAND may enter into further devices or can be used together with other appliances. With these third party products and appliances in particular, please note the EFUP labeled on these products. BRAND will not take responsibility for the EFUP of those products and appliances.

Place, date: Wertheim, 25/02/2019

**Hans-Walter Kern**  
(Managing Director  
Logistics and Production)

i.A.  
**Josef Pfohl**  
(Quality Management)





