

## Instruction Manual



## WB 12/WB 22/WB Pump

# Summary

- 1 Warranty ..... 1
- 2 Contents of package ..... 1
- 3 First use ..... 1
  - 3.1 Getting started ..... 1
  - 3.2 Filling of the tank ..... 1
  - 3.3 Instrument parts ..... 2
- 4 Display and commands ..... 3
- 5 Operation ..... 4
  - 5.1 Switching on the instrument ..... 4
  - 5.2 Turn on/off of the circulation pump (if present) ..... 4
  - 5.3 Setting of parameters ..... 4
    - 5.3.1 Working temperature ..... 4
    - 5.3.2 Working time ..... 4
  - 5.4 Start/stop heating cycle ..... 5
  - 5.5 Functions with password access ..... 5
    - 5.5.1 Access to menu with password ..... 5
    - 5.5.2 Delay of heating cycle start ..... 5
    - 5.5.3 Safety temperature limiter for samples protection ..... 6
    - 5.5.4 Restart mode after absence of power supply ..... 7
    - 5.5.5 Temperature range for over temperature alarm ..... 7
    - 5.5.6 Temperature offset on single point, on entire ramp, on room temperature sensor ..... 8
- 6 Emptying of the tank ..... 8
  - 6.1 Use of the emptying kit (if present pump) ..... 9
- 7 Clean and maintenance ..... 10
- 8 Disposal of electronic equipment ..... 10
  - 8.1 Technical specifications and service contact ..... 10

# 1 Warranty

Thank you for purchasing a water bath from Phoenix instrument. In normal use conditions, the instrument is guaranteed for a period of 24 months from the date of purchase. The warranty is valid only if the product is original. It does not apply to any product or parts of it that have been damaged due to incorrect installation, improper connections, improper use, accident or abnormal conditions of operation. The manufacturer declines all responsibility for damage caused by failure to follow instructions, lack of maintenance and any unauthorized modification.

## 2 Contents of package

The instrument is delivered complete with the following parts:

1. Water bath
2. Stainless steel bottom plate
3. Emptying kit (in case of presence of pump)
4. Power supply cable
5. User manual

## 3 First use

### 3.1 Getting started

The water bath should be installed in follow conditions:

1. Dry, clean and stable work table with a flat horizontal surface
2. Respect minimum spaces of 20 cm around instrument
3. Room temperature between 5 °C and 40 °C, and relative humidity maximum of 85%
4. Power supply socket with earth connection
5. Power feed between 220-240 V - 50 Hz



### 3.2 Filling of the tank

**Fill the tank with deionized water. The water level must always be above the outlet nozzle of the pump (where present), or in any case in such quantity as to leave uncovered the heating element (see Picture 1).**

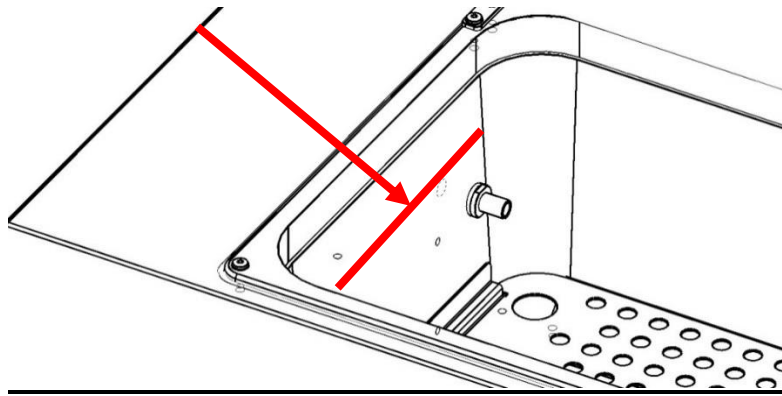
**ATTENTION: during the filling of the tank must always consider the natural evaporation of water. You must therefore always maintain a sufficient level of water (at least 4-5 cm below the upper edge of the tank), see Picture 1 .**



Picture 1

<b>IMPORTANT:</b>	The water bath is designed to be used <b>ONLY</b> with non-flammable liquids
 <b>ATTENTION!</b>	<u>The tank of the water bath should never be filled with a liquid other than water!</u>
 <b>ATTENTION!</b>	<u>Never use the water bath without first putting the water inside the bath!</u>

### 3.3 Instrument parts







- Opening / closing handle
- Lid
- Display
- Adjustment keys
- ON/OFF Power  
ON/OFF Pump

Picture 2 – Front of the water bath

## 4 Display and commands



Picture 3 – Display

<b>COMMANDS</b>	<b>DESCRIPTION</b>
	The SET/PROG button permits the working parameters setting. In combination with the SHIFT key allows access to menus with password (see paragraph 5.5).
	The SHIFT button permits to change quickly the digit (decimal, units, tens, etc.) of the value of the parameter you are editing. In combination with the SET/PROG key allows access to menus with password (see paragraph 5.5).
	Adjustment buttons allow you to increase or decrease the value of the operating parameter being edited.
	The START / STOP button permits to start / stop an operation cycle.
	The ON / OFF button allows you to turn on and off the instrument
	The ON/OFF “Pump” allows you to turn on and off the circulation pump (if present).

# 5 Operation

## 5.1 Switching on the instrument

### **Before turning the power you need to fill it with water (see paragraph 3.2)**

Turn on the instrument by pressing the button ON / OFF. Button and the display will light up.

The display shows the initialization sequence and then the instrument is ready for use.

**NOTE:** every time you turn the instrument beeps intermittently, the icon of visual alarm  and the word "end" appear on the display, indicating that a heating cycle had been done before. Press any button to silence the audible signal and the icon  appears.

## 5.2 Turn on/off of the circulation pump (if present)

If installed, the circulation pump can be switched on or off at any time using the button "Pump". The pump can be operated only if the instrument is switched on, when the "Power" button is in the ON position.

**NOTE:** in the first use or after emptying of the tank of the water bath is possible that the pump has at its internal air bubble and therefore functions "vacuum". If during this stage you hear a sucking sound abnormal aspiration, immediately turn off the pump and bring the water level above the nozzle outlet of the heat pump (see paragraph 3.2).

## 5.3 Setting of parameters

### 5.3.1 Working temperature

When the instrument is switched on, pressing one time the SET/PROG  button, the set temperature value starts to blink.



Set the desired temperature value (in Celsius degrees) pressing  keys.

It's possible a quick movement between the digits using the SHIFT  button.



Confirm the set value with another press of SET/PROG  button.

### 5.3.2 Working time

After confirming the temperature, the last value of the set time (timer) starts flashing.

Set the desired value (hh:mm) by pressing  keys. It's possible a quick movement between the digits using the SHIFT  button.

Confirm the set value with another press of SET/PROG  button.



**NOTE:** the value "00:00" indicates the operating mode "continuous", that means once you start the operating cycle by the START / STOP  button, it continues maintaining the set temperature until it is stopped manually (START/STOP ).

If you set a value of time, such as 1 hour, the instrument will reach the set temperature and will maintain it for an hour.

## 5.4 Start/stop heating cycle

After setting the operating parameters, pressing START / STOP  button with long press (4-5 seconds), the heating cycle starts for the defined time in hh:mm or continuous (00:00). The word “end” at the top right corner of display disappears, the message RUN appears in the bottom left corner and display shows contemporary: timer, temperature measured inside the tank and set temperature (see Picture 3).

At any time you can always manually stop the cycle by pressing the START / STOP  button.



Once the set time or after manual stop, the instrument beeps intermittently, the icon of visual alarm  and the word "end" appear on the display. Pressing any button it's possible to silence the audible signal and the icon  appears.

**NOTE:** the acoustic signal will not end until it is stopped by the operator, but the heating cycle is terminated so for the samples inside the instrument will remain exposed to the internal temperature of the tank.

## 5.5 Functions with password access

### 5.5.1 Access to menu with password

Simultaneously pressing the SET / PROG  and SHIFT  for few seconds, you can access some functions and parameters that are password protected.

To access these submenus and avoid mistakenly entering in the operating parameters setting, it is recommended to firstly press the SHIFT  key, keep it pressed, and then press the SET / PROG  for few seconds.

After have made this keys combination, on the right top part of display instead of word TIME, “Lk” (lock) appears close to “0000” (password).

Below the passwords and access sequence to the various parameters/functions.



<b>PASSWORD</b>	<b>FUNCTION/ PARAMETER</b>	<b>DESCRIPTION</b>
0000	dy	Delay of heating cycle start
0003	tm	Safety temperature limiter for samples protection
	Po	Restart mode after absence of power supply
	AL	Temperature range for over temperature alarm
	Pb	Temperature offset on single point
	PK	Temperature offset on the entire ramp
	PA	Temperature offset of the room temperature probe

### 5.5.2 Delay of heating cycle start

It's possible to set a delay (hour and minutes) of heating cycle start.

Please follow the instructions reported at paragraph 5.5.1 and confirm the “0000” password pressing shortly one time SET/PROG .

On the top right part of display the parameter “dy” (delay) appears close to value 00:00.

Set the desired delay value (hh:mm) pressing  keys. It's possible a quick movement between the digits using the SHIFT  button. Confirm the set value with another press of SET/PROG  button.



The display comes back to the standby screen (see Picture 3).

Pressing the START/STOP  button with long press (4-5 seconds) the instrument starts the work cycle but it doesn't immediately heat: the word "end" and the set delay time alternately blink on the top right part of display, counting the wait time until the real starting of heating.

Once the delayed time is passed the instrument starts to heat and the regular timer appears on display.



### ***5.5.3 Safety temperature limiter for samples protection***

The instrument has the possibility to limit the maximum work temperature for the samples protection from an erroneous setting of the working temperature.

Please follow the instructions reported at paragraph 5.5.1 and using the  keys set the "0003" password. It's possible a quick movement between the digits using the SHIFT  button.

Confirm the set value with another press of SET/PROG  button.

On the top right part of display the parameter "tm" (temperature max) and the maximum expected value for the kind of instrument appear.

Set the maximum temperature value you want the instrument doesn't exceed during work cycle by the  keys. It's possible a quick movement between the digits using the SHIFT  button.

Confirm the set value with another press of SET/PROG  button.

#### **Example**

If the set temperature for the work cycle is 100 °C and the safety temperature is fixed at 70°C, the instrument tries to achieve the set temperature (100°C), even if it's major than the safety temperature set in this menu (tm).

When the 70 degrees are achieved the instrument goes in alarm emitting an audible intermittent alarm (silence it pressing any keys) and the heating element doesn't receive power supply until to the temperature will go below the safety temperature (tm).



**NOTE:** the instrument tries in any moment to achieve the set work temperature; as a consequence, until it is bigger than the safety temperature (tm), it goes in over temperature alarm as described in the previous paragraph.





### 5.5.4 Restart mode after absence of power supply

It's possible to set the restart mode of the instrument after a power supply absence:

<i>Po</i> VALUE	DESCRIPTION
0	On return of the power supply, the instrument does not automatically resume the heating cycle, but you must manually restart.
1	On return of the power supply, the instrument automatically resumes operation from the beginning of the heating cycle interrupted
2	On return of the power supply, the instrument automatically resumes operation at the very point of the heating cycle in which it was interrupted

Please follow the instructions reported at paragraph 5.5.1 and using the  keys set the "0003" password. It's possible a quick movement between the digits using the SHIFT  button.

Confirm the set value with another press of SET/PROG  button.

On the top right part of display the parameter "tm" (temperature max), pass to the next parameter "Po" (Power) pressing shortly SET/PROG .



Confirm pressing shortly another time SET/PROG . Set the desired value (0, 1, 2) pressing the  keys. Confirm pressing shortly SET/PROG .

### 5.5.5 Temperature range for over temperature alarm

The instrument has the opportunity to set the range of temperature over which it goes in over temperature alarm.



**NOTE:** even if this value is adjustable by the operator, it's already set by factory and perfectly calibrated in function of instrument type, natural/forced air oven, incubator or water bath.

We recommend to do not change this value unless absolutely necessary, because temperature fluctuations more or less than the set one, especially in models with natural convection, are normal and thus reducing dramatically the value of AL, it would risk do go frequently and unnecessarily alarmed the instrument.

Please follow the instructions reported at paragraph 5.5.1 and using the  keys set the "0003" password. It's possible a quick movement between the digits using the SHIFT  button.

Confirm the set value with another press of SET/PROG  button

On the top right part of display the parameter "tm" (temperature max), pass to the next parameters pressing shortly SET/PROG  more times.



Find the parameter AL (alarm), set the minimum temperature value above which you want the instrument goes in alarm pressing the  keys. It's possible a quick movement between the digits using the SHIFT  button. Confirm the set value with another press of SET/PROG  button.

### 5.5.6 Temperature offset on single point, on entire ramp, on room temperature sensor

The instrument has the opportunity to set the offset value on a single temperature point, on the entire temperature ramp and on the room temperature sensor.

**NOTE:** even if these values are adjustable by the operator, they are already set by factory and perfectly calibrated with certified and referable Accredia measurement instruments.

We recommend that you do not change these values unless absolutely necessary, for example if after a check with digital certified thermometer you find a discrepancies between the reading of the instrument and the external thermometer.

Please follow the instructions reported at paragraph 5.5.1 and using the  keys set the "0003" password. It's possible a quick movement between the digits using the SHIFT  button.

Confirm the set value with another press of SET/PROG  button

On the top right part of display the parameter "tm" (temperature max), pass to the next parameters pressing shortly SET/PROG  more times.

<b>PARAMETER</b>	<b>DESCRIPTION</b>
<b>Pb</b>	Changing this parameter you can correct the reading of PT100 sensor inside the instrument on one point temperature. The correction will therefore be attributable to one specific point.
<b>PK</b>	Changing this parameter you can correct the reading PT100 sensor inside the instrument over the entire temperature ramp, that is going to change the inclination of the ramp reading of the sensor.
<b>PA</b>	Changing this parameter you can correct the reading of environmental PT100 sensor installed on the instrument (only refrigerated versions) on only one temperature point. The correction will therefore be attributable to one specific point.

## 6 Emptying of the tank



**ATTENTION!**

**When you want to empty the tank of the water bath is essential that the heating element is no longer powered and was first cooled down.**

For this reason it is necessary, therefore, before emptying the water bath to stop the cycle of heating and wait until the water has cooled.:



**ATTENTION!**

**Before proceeding with the removal of water wait until it has sufficiently cooled!!!**

Once cooled, it's possible to emptying with help of a tank and / or absorbent cloth or paper.

For the instruments with circulation pump, it's possible to proceed as indicated below.

## 6.1 Use of the emptying kit (if present pump)

If the instrument is equipped with circulation pump is able to use for the emptying of the water bath together with a kit of emptying rubber provided with the instrument

The water bath can be emptied using the above kit as follows:

1. **Wait for the cooling of the water;**
2. Turn off the circulation pump by the switch “Pump”;
3. Using to the special double cone white, connect the short tube to the suction nozzle of the pump at the bottom of the tank (see Picture 4);
4. Connect the long tube to the output nozzle in the top of the tank. Put the other terminal of the tube in a recipient of a sufficient capacity (see Picture 4);
5. Switch on the pump through the button ON/OFF “Pump” to start the emptying: in this way the pump transfer the water from the tank into the external recipient;
6. Using the shorter tube take away the remaining water on the bottom of the tank and once the pump start to work at vacuum switch it off immediately;
7. If necessary remove the last traces of water with an absorbent cloth or paper.



**ATTENTION!**

**The pump musn't be use at vacuum, but only for the circulation of water, because it is designed to pump liquids and not air.**



*Picture 4 – Emptying kit for water bath with pump*

## 7 Clean and maintenance

Proper maintenance and cleaning of the instrument guarantee its good conditions.

The tank of the instrument is made of stainless steel, so it can be cleaned with any detergent provided it is not aggressive and / or corrosive.

You should clean the inside and outside surfaces with a standard all-purpose cleaner sprayed on a soft cloth.

Before proceeding with any cleaning or decontamination, the user must ensure that the method used does not damage the instrument.



**ATTENTION!**

**In case of use of absorbent paper, take particular care to avoid that traces of it remain inside the tank.**

**Eventually pieces of paper can gravely damage the pump.**

### IMPORTANT:

If the instrument must be returned for service, it is necessary to provide for proper cleaning and possible decontamination by pathogens of the same.

It is also recommended to put the instrument in its original packaging to send it in for repairs and if it is missed it is necessary to provide to pack it properly in order to the transport.

Any damage caused from the incorrect shipping will not be covered by warranty.

## 8 Disposal of electronic equipment



The electrical and electronic equipment marked with this symbol may not be disposed of in landfills.

In accordance with EU Directive 2002/96/EC, the European users of electrical and electronic equipment have the opportunity to give back to the distributor or manufacturer upon purchase of a new one.

The illegal disposal of electrical and electronic equipment is punished with an administrative fine.

## Technical Specifications

Water bath	WB-12	WB-22	WB22-pump
Usable Volume	12 Liters	22 Liters	22 Liters
Max. Temperature/Resolution	+100/0,1°C	+100/0,1°C	+ 85/0,1°C
Temperature homogeneity at 37°C	±0,5°C	±0,5°C	±0,2°C
Temperature variation at 37°C	±0,1°C	±0,1°C	±0,1°C
Timer	99:59 and infinity	99:59 and infinity	99:59 and infinity
Overheating protection	Yes	Yes	yes
Bottom plate Dimension (WxHxD)	390 x 220 mm	490 x 290 mm	490x 290 mm
Min. height with closed lid	150mm	150mm	150mm
Voltage/Power	230V/800W	230V/1100W	230V/1100W
External Dimension (WxHxD) in mm	480 x 375 x 310	680 x 395 x 310	680 x 395 x 310
Weight (kg)	12	18	19
Safety class	2	2	2

## Service

When help needed, please contact your local distributor our the service department of Phoenix Instrument GmbH for technical support in the following ways:

Phoenix Instrument GmbH  
Heinkelstraße 10  
30827 Garbsen  
05131/9081830  
info@phoenix-instrument.de

Phoenix Instrument GmbH – Heinkelstraße 10 – 30827 Garbsen  
Telefon 05131 90818-30 – info@phoenix-instrument.de