

# Transferpette® -8/-12 electronic

Gebrauchsanleitung · Operating Manual · Mode d'emploi

Instrucciones de manejo · Istruzioni per l'uso · 操作手册





# EU-Konformitätserklärung

## EU-Conformity Declaration

Handelsname des Produktes / Trade name of the device:	Kolbenhubpipette Transferpipette* / Piston-operated pipette Transferpipette*
Produktvarianten / Device variations:	-a, -S, -electronic, /-8, /-12, (0,5-10 µl, 1-20 µl, 2-20 µl, 5-100 µl, 10-200 µl, 15-300 µl, 50-1.000 µl, 250-5.000 µl) inkl. Netzteil und Pipettenspitzen 0,1 – 10.000 µl / -a, -S, -electronic, /-8, /-12, (0,5-10 µl, 1-20 µl, 2-20 µl, 5-100 µl, 10-200 µl, 15-300 µl, 50-1.000 µl, 250-5.000 µl) incl. Charging adapter and Pipette-tips 0,1 – 10.000 µl
Art.-Nr. / Cat.-No.:	703700, 703706, 703708, 703710, 703712, 703720, 703726, 703728, 703730, 703732, 704708, 704716, 704720, 704728, 704738, 704744, 704754, 704762, 704764, 704768, 704769, 704770, 704772, 704773, 704774, 704778, 704780, 704782, 704784, 704790, 704791, 704792, 704793, 704850, 704851, 704969, 704970, 704971, 704972, 704973, 704974, 704975, 704976, 704977, 704978, 704979, 704980, 704981, 704982, 704983, 704984, 705299, 705300, 705303, 705306, 705307, 705309, 705310, 705313, 705316, 705317, 705319, 705320, 705323, 705326, 705327, 705329, 705330, 705333, 705336, 705337, 705339, 705340, 705343, 705346, 705347, 705399, 705400, 705403, 705404, 705406, 705409, 705410, 705413, 705414, 705416, 705419, 705420, 705423, 705424, 705426, 705429, 705430, 705433, 705434, 705436, 705449, 705450, 705453, 705454, 705456, 705459, 705460, 705463, 705464, 705466, 705469, 705470, 705473, 705474, 705476, 705479, 705480, 705483, 705484, 705486, 705808, 705816, 705820, 705828, 705838, 705844, 705854, 705862, 705864, 705868, 705869, 705870, 705872, 705873, 705874, 705878, 705880, 705882, 705884, 705890, 705891, 705892, 705893, 705896, 705897, 705900, 705906, 705908, 705910, 705912, 705920, 705926, 705928, 705930, 705932, 705990  702595, 702600, 702603, 702604, 702605, 702608, 732002, 732004, 732006, 732008, 732010, 732012, 732022, 732024, 732026, 732028, 732030, 732032, 732102, 732104, 732106, 732108, 732110, 732112, 732122, 732124, 732126, 732128, 732130, 732132, 732202, 732204, 732206, 732208, 732210, 732212, 732222, 732224, 732226, 732228, 732230, 732232, 732244, 732248, 732252, 732264, 732268, 732272, 732302, 732304, 732306, 732308, 732310, 732312, 732322, 732324, 732326, 732328, 732330, 732332, 732344, 732348, 732352, 732364, 732368, 732372, 732502, 732504, 732506, 732508, 732510, 732512, 732514, 732602, 732604, 732606, 732608, 732610, 732612, 732614, 732622, 732624, 732626, 732628, 732630, 732632, 732634, 732702, 732704, 732706, 732708, 732710, 732712, 732714, 732722, 732724, 732726, 732728, 732730, 732732, 732734, 732802, 732804, 732806, 732808, 732810, 732812, 732814, 732822, 732824, 732826, 732828, 732830, 732832
DIMDI-Reg.-Nr. / DIMDI reg-no.:	DE/CA37/IVD/3/13A1
Hersteller / Manufacturer:	BRAND GMBH + CO KG  Otto-Schott-Str. 25 97877 Wertheim

Seite/Page 1-2

Wir als Hersteller übernehmen die alleinige Verantwortung für das/die oben beschriebenen Produkt(e) und erklären hiermit, dass das/die beschriebene(n) Produkt(e) der/den folgenden Richtlinie(n)/Verordnung(en) entspricht/entsprechen: We, as the manufacturer of the above described device(s) take sole responsibility for and hereby declare that the described device(s) meet(s) the provisions of the following Regulation(s)/Directive(s):	Angewendete harmonisierte Normen: Applied harmonized standards:
IVD 98/79/EG (Fst.: Ref./Abt. L331, 7.12.1998, S. 1-37; OJ L331, 7.12.1998, p. 1-37)	EN 61010-2-101:2002 EN 61326-2-6:2006
RoHS: 2011/65/EU (Fst.: Ref./Abt. L174, 1.7.2011, S. 88-110; OJ L174, 1.7.2011, p. 88-110) incl. 2015/863/EU (Fst.: Ref./Abt. L137, 4.6.2015, S. 10-12; OJ L137, 4.6.2015, p. 10-12)	EN IEC 63000:2018
Weitere angewendete Normen / Other applied standards	Geltungsbereich/ Scope
EN 60950-1:2006 + A11:2009 + A12:2011 + A1:2010 + A2:2013 EN 61010-1:2010 EN 61326-1:2013 DIN EN ISO 8655-2 DIN EN ISO 8655-6	LVD 2014/35/EU LVD 2014/35/EU EMC 2014/30/EU Volumenmessgeräte mit Hubkolben / Piston- operated volumetric apparatus

**IVD-Klasse / IVD Class :**

- Liste A nach Anhang II / list A according Annex II       Liste B nach Anhang II / list B according Annex II
- Produkt zur Eigenanwendung / device for self-testing       Sonstiges Produkt / Other device (all devices except Annex II and self-testing devices)

**Konformitätsbewertung / Conformity route :**

- Anhang III (mit Ausnahme Abs. 6), EU-Konformitätserklärung / Annex III (except para. 6), EC declaration of conformity

Wertheim, 2. Juli 2020 / July 2, 2020

# 08.19.01.01

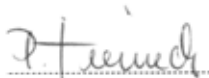

Patrick Ziemeck  
Technischer Geschäftsführer  
Managing Director Technology



i.A. Siegfried Ott  
Regulatory Affairs



Diese Erklärung bescheinigt die Übereinstimmung mit den genannten Harmonisierungsvorschriften,  
beinhaltet jedoch keine Zusicherung von Eigenschaften.  
This document declares the accordance with the named harmonized regulations, but does NOT assure specific properties.

	Seite
Sicherheitsbestimmungen	4
Funktion und Einsatzgrenzen	5
Einsatzausschlüsse	5
<b>Die Bedienelemente</b>	<b>6</b>
Die ersten Schritte	7
Volumen einstellen	8
Aufsaug- und Abgabegeschwindigkeit einstellen	9
Richtig pipettieren	10
Die Pipettierprogramme	11
<b>PIP-Modus</b>	<b>12</b>
<b>PIPmix-Modus</b>	<b>14</b>
<b>revPIP-Modus</b>	<b>16</b>
<b>Elektrophorese (GEL)-Modus</b>	<b>18</b>
<b>DISP-Modus</b>	<b>20</b>
Volumen kontrollieren	22
Genauigkeitstabelle	23
<b>Easy Calibration (Justieren)</b>	<b>24</b>
Autoklavieren	26
Referenzfahrt (rEF)	26
Wartung und Reinigung	27
Akku laden und wechseln	32
Akku-Regenerationsfunktion	33
Störung – was tun?	34
Kennzeichnung auf Gerät	35
Bestelldaten · Zubehör · Ersatzteile	36
Reparatur · Kontaktadressen	38
Kalibrierservice · Mängelhaftung	39
Entsorgung	40

# Sicherheitsbestimmungen

Dieses Gerät kann in Kombination mit gefährlichen Materialien, Arbeitsvorgängen und Apparaturen verwendet werden. Die Gebrauchsanleitung kann jedoch nicht alle Sicherheitsprobleme aufzeigen, die hierbei eventuell auftreten. Es liegt in der Verantwortung des Anwenders, die Einhaltung der Sicherheits- und Gesundheitsvorschriften sicherzustellen und die entsprechenden Einschränkungen vor Gebrauch festzulegen.

## Bitte unbedingt sorgfältig durchlesen!

1. Jeder Anwender muss diese Gebrauchsanleitung vor Gebrauch des Geräts gelesen haben und beachten.
2. Allgemeine Gefahrenhinweise und Sicherheitsvorschriften befolgen, z. B. Schutzkleidung, Augenschutz und Schutzhandschuhe tragen. Beim Arbeiten mit infektiösen oder gefährlichen Proben müssen die Standardlaborvorschriften und -vorkehrungen eingehalten werden.
3. Angaben der Reagenzienhersteller beachten.
4. Gerät nicht in explosionsgefährdeter Atmosphäre betreiben und keine leicht entzündlichen Medien pipettieren.
5. Gerät nur zum Pipettieren von Flüssigkeiten im Rahmen der definierten Einsatzgrenzen und -beschränkungen einsetzen. Einsatzausschlüsse beachten (s. Seite 5)! Bei Zweifel unbedingt an den Hersteller oder Händler wenden.
6. Stets so arbeiten, dass weder Anwender noch andere Personen gefährdet werden. Spritzer vermeiden und geeignetes Auffanggefäß verwenden.
7. Die Berührung der Spitzenöffnungen ist beim Arbeiten mit aggressiven Medien zu vermeiden.
8. Nie Gewalt anwenden.
9. Nur Original-Ersatzteile verwenden. Keine technischen Veränderungen vornehmen. Das Gerät nicht weiter zerlegen, als in der Gebrauchsanleitung beschrieben ist!
10. Vor Verwendung stets den ordnungsgemäßen Zustand des Gerätes prüfen. Sollten sich Störungen des Gerätes ankündigen (z. B. schwergängiger Kolben, Undichtigkeit), sofort aufhören zu pipettieren und das Kapitel 'Störung – was tun' befolgen (Seite 34), ggf. an den Hersteller wenden.
11. Der Original-Akku darf nicht gegen nicht-wiederaufladbare Akkus oder wiederaufladbare Akkus anderer Hersteller ausgetauscht werden.
12. Zum Aufladen der Nickel-Metallhydrid-Akkus darf nur das Original-Netzteil verwendet werden.
13. Das Netzteil ist vor Feuchtigkeit zu schützen und darf nur in Verbindung mit diesem Gerät betrieben werden.
14. Nur vollständig entladene Akkus entsprechend der Batterieverordnung entsorgen.

## Warnung!

Unsachgemäße Behandlung des Gerätes oder der Akkus (Kurzschluss, mechanische Zerstörung, Überhitzung, falsches Netzteil etc.) kann in Extremfällen zur Explosion des Akkus führen.

Bei der Transferpette®-8/-12 electronic handelt es sich um eine mikroprozessorgesteuerte, akkubetriebene Mehrkanal-Kolbenhubpipette nach dem Luftpolsterprinzip zum Pipettieren von wässrigen Lösungen mittlerer Dichte und Viskosität.

Bei richtiger Handhabung des Gerätes kommt die zu dosierende Probe nur mit den Spitzen und nicht mit der Transferpette®-8/-12 electronic in Berührung.

## Einsatzgrenzen

Das Gerät dient zum Pipettieren von Proben unter Beachtung folgender Grenzen:

- Einsatztemperatur von +15 °C bis +40 °C (von 59 °F bis 104 °F) von Gerät und Reagenz (andere Temperaturen auf Anfrage)
- Dampfdruck bis 500 mbar
- Viskosität: 260 mPa s

## Einsatzausschlüsse

Der Anwender muss die Eignung des Geräts für den Verwendungszweck selbst überprüfen.

Das Gerät nicht zum Pipettieren von Flüssigkeiten einsetzen, die Polypropylen, Polyvinylidenfluorid und Silikon (Schaft & Spitzen) oder Polycarbonat/ Polybutylenterephthalat (Gehäuse) oder EPDM (flexible Ersatz-Pipettenschäfte) angreifen. Aggressive Dämpfe meiden (Korrosionsgefahr)!

Das Griffteil ist nicht autoklavierbar.

## Einsatzbeschränkungen

Viskose und benetzende Flüssigkeiten können die Genauigkeit des Volumens beeinträchtigen. Ebenso Flüssigkeiten, deren Temperatur mehr als  $\pm 5$  °C / 41 °F von der Raumtemperatur abweicht.

## Akku- und Netzteil-Spezifikationen

### Akku

Nickel-Metallhydrid-Akku mit 3 zylindrischen Einzelzellen der Größe AAA, 3,6 V, 700 mAh

### Netzteil

Ausgangsspannung 6,5 V DC, 200 mA

# Die Bedienelemente

Die Transferpette®-8/-12 electronic ist eine auf Bedienungsergonomie und Arbeitserleichterung optimierte mikroprozessorgesteuerte, akkubetriebene Mehrkanal-Kolbenhubpipette.

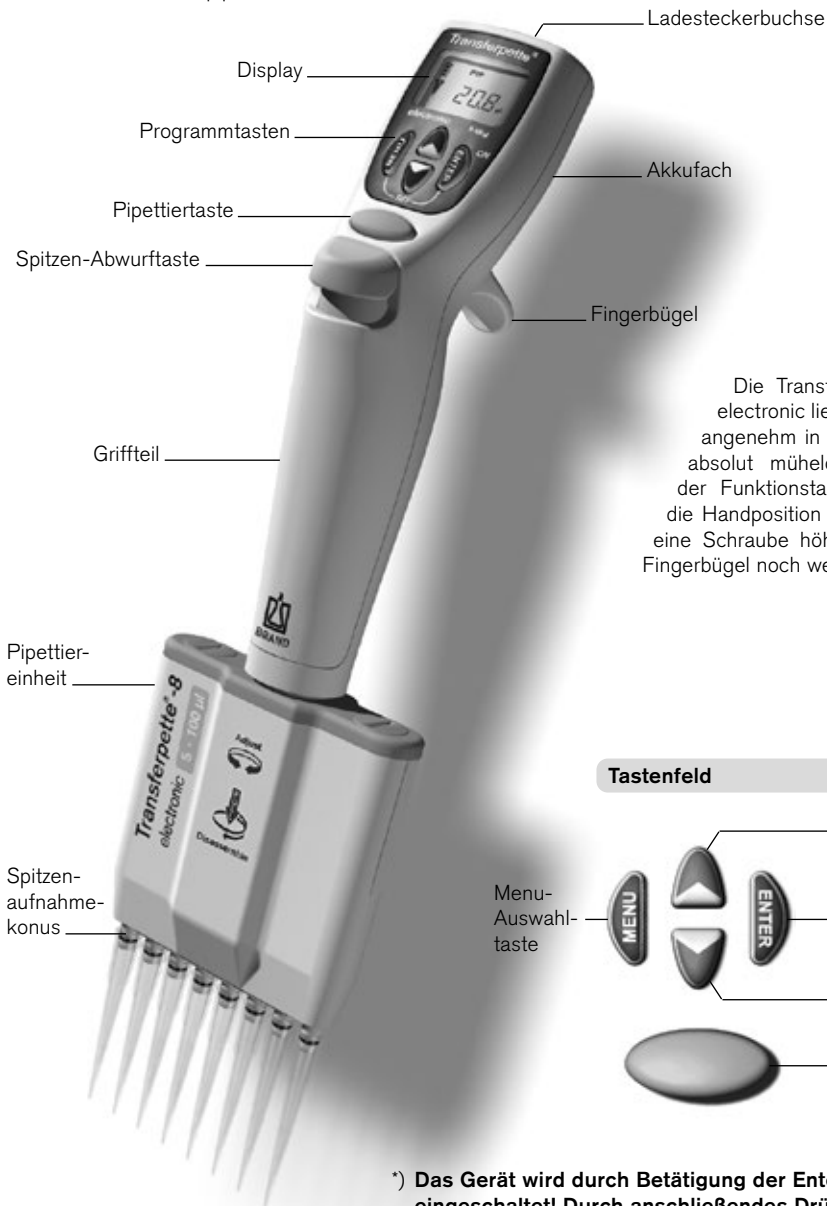

Die Transferpette®-8/-12 electronic liegt ergonomisch angenehm in der Hand. Zum absolut mühelosen Bedienen der Funktionstasten lässt sich die Handposition durch den über eine Schraube höhenverstellbaren Fingerbügel noch weiter optimieren.

## Tastenfeld

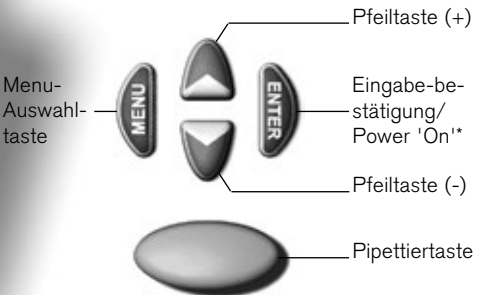

**\*) Das Gerät wird durch Betätigung der Enter-Taste eingeschaltet! Durch anschließendes Drücken der Pipettiertaste ist das Gerät pipettierbereit.**  
 Die Transferpette®-8/-12 electronic schaltet sich 10 min nach der letzten Bedienung selbsttätig aus (Auto-Power-Off).



## Ist alles in der Verpackung?

In der Verpackung befindet sich Ihre Transferpette®-8 oder -12 electronic, ein Akku, das Steckernetzteil mit Akku-Ladekabel, 1 Gerüststander, 1 Reagenzreservoir, Silikonfett, diese Gebrauchsanleitung sowie 1 Satz O-Ringe aus Silikon.

### Inbetriebnahme der Transferpette®-8/-12 electronic

#### 1. Akku einsetzen

a) Deckel des Akku-Fachs öffnen.



b) Akku einlegen. Darauf achten, dass der Stecker des Akkus fest in die Buchse im Gerät eingesteckt wird.



c) Deckel des Akku-Fachs wieder einsetzen und schließen.



#### 2. Gerät aktivieren

Die Transferpette®-8/-12 electronic fordert direkt nach dem Einsetzen des Akkus automatisch eine Referenzfahrt an. Nach dem Drücken der Pipettiertaste wird die Referenzfahrt durchgeführt und das Gerät ist pipettierbereit!



Das Display zeigt den werkseitig eingestellten Standard-Pipettiermodus (PIP) und das jeweilige Nennvolumen (hier z. B. 100,0 µl). Aufsaug- und Abgabegeschwindigkeit sind werkseitig maximal eingestellt. Die einfache Volumen- und Geschwindigkeitseinstellung ist auf den nachfolgenden Seiten beschrieben.

Pipettiermodus

Akku-Kapazitätsanzeige



Pfeilsymbol für 'Aufsaugen'

Volumenanzeige



# Volumen einstellen

Das Volumen ist werkseitig auf das jeweilige Nennvolumen der Transferpette®-8/-12 electronic eingestellt und kann einfach und schnell individuell verändert werden.

Was muss ich tun?	Wie geht das?	Welche Taste?	Was zeigt das Display?
<b>1. Volumenauswahl aktivieren</b>	Durch Drücken einer der Pfeiltasten erfolgt die direkte Auswahl eines Volumens. 'VOL' blinkt.		
<b>2. Volumen einstellen</b>			
<b>verringern</b>	Durch Drücken der Pfeiltaste (-) wird das Volumen verringert. Anhaltendes Drücken der Pfeiltaste führt zur schnellen Volumenveränderung. 'VOL' blinkt weiterhin.		
<b>erhöhen</b>	Durch Drücken der Pfeiltaste (+) wird das Volumen erhöht. Anhaltendes Drücken der Pfeiltaste führt zur schnellen Volumenveränderung. 'VOL' blinkt weiterhin.		
<b>3. Volumenauswahl bestätigen</b>	Enter-Taste drücken. Das Display zeigt jetzt das neu eingestellte Volumen an, hier z. B. das Display des standardmäßig eingestellten PIP-Modus.		

## Wichtig:

Durch Betätigung der Menü-Taste kann jeder Einstellvorgang abgebrochen werden! Das Display springt dann zur nächsten Einstellmöglichkeit oder zur Ausgangsanzeige zurück.

# Aufsaug- und Abgabegeschwindigkeit einstellen

Aufsaug- und Abgabegeschwindigkeit sind separat einstellbar. Beim Menü-Aufruf wird die jeweils zuletzt eingestellte Geschwindigkeit angezeigt. 5 Geschwindigkeitsstufen stehen jeweils zur Verfügung.

Was muss ich tun?	Wie geht das?	Welche Taste?	Was zeigt das Display?
-------------------	---------------	---------------	------------------------

## Aufsauggeschwindigkeit einstellen

- |                                      |   |    |  |
|--------------------------------------|---|----|--|
| 1. Menü aufrufen                     | Durch einmaliges, kurzes Drücken der Menü-Taste gelangt man in das Menü Aufsauggeschwindigkeit. 'Speed' blinkt.   | 1x |  |
| 2. Aufsauggeschwindigkeit einstellen | Durch Betätigung der Pfeiltasten (+/-) wird die Geschwindigkeitsstufe ausgewählt (z. B. Stufe 5). 'Speed' blinkt weiterhin.                                     |    |  |
| 3. Geschwindigkeitsstufe bestätigen  | Enter-Taste drücken. Das Display kehrt wieder in den Grundzustand des jeweils eingestellten Modus zurück, hier z. B. das Display des standardmäßigen PIP-Modus. | 1x |  |

## Abgabegeschwindigkeit einstellen

- |                                     |   |    |  |
|-------------------------------------|---|----|--|
| 1. Menü aufrufen                    | Durch zweimaliges, kurzes Drücken der Menü-Taste gelangt man in das Menü Abgabegeschwindigkeit. 'Speed' blinkt.   | 2x |  |
| 2. Abgabegeschwindigkeit einstellen | Durch Betätigung der Pfeiltasten (+/-) wird die Geschwindigkeitsstufe ausgewählt (z. B. Stufe 2). 'Speed' blinkt weiterhin.   |    |  |
| 3. Geschwindigkeitsstufe bestätigen | Enter-Taste drücken. Das Display kehrt jetzt wieder in den Grundzustand des jeweils eingestellten Modus zurück, hier z. B. das Display des standardmäßigen PIP-Modus. | 1x |  |

Das Volumen ist werkseitig auf das jeweilige Nennvolumen der Transferpette®-8/-12 electronic eingestellt und kann einfach und schnell individuell verändert werden (s. Seite 8).

## Quick Start im Standard-Pipettiermodus

**1. Spitzen aufstecken** Richtige Spitzen entsprechend dem Volumenbereich bzw. Color-Code verwenden! Auf dichten und festen Sitz der Spitzen achten. Pipettenspitzen sind Einmalartikel!

**2. Pipettiereinheit ausrichten** Die Pipettiereinheit lässt sich in beide Richtungen frei drehen.

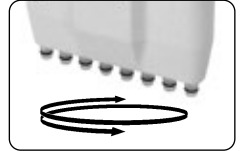

**3. Flüssigkeit aufnehmen** Gerät senkrecht halten und Spitzen 2-3 mm in die Flüssigkeit eintauchen.



Durch Betätigung der Pipettiertaste wird die Flüssigkeit aufgesaugt. Der Pfeil im Display zeigt nach oben (Aufnahme).



**Hinweis:** Damit keine Luft angesaugt wird, Spitzen noch ca. 1 s eingetaucht lassen.

**4. Flüssigkeit abgeben** Nach Abschluss der Flüssigkeitsaufnahme zeigt der Pfeil im Display nach unten (Abgabe).

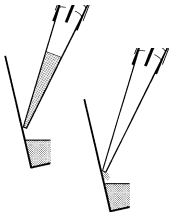

Pipettenspitzen an Gefäßwand anlegen. Pipette im Winkel von 30-45° halten.

Durch erneute Betätigung der Pipettiertaste wird die Flüssigkeit vollständig mit automatischem Überhub abgegeben. Pipettenspitze danach an der Gefäßwand abstreifen.



**5. Spitzen abwerfen** Pipettiereinheit über einen geeigneten Entsorgungsbehälter halten und die Spitzenabwurf-taste niederdrücken.

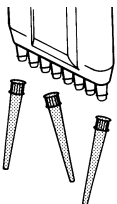









Spitzen-abwurf-taste

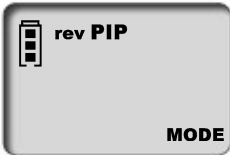

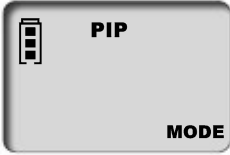

**Hinweis:** Die ISO 8655 schreibt vor, die Pipettenspitzen vor dem eigentlichen Pipettiervorgang einmal mit der Probenflüssigkeit vorzuspülen.

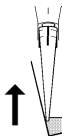

	Seite
<b>1. Normales Pipettieren</b>	
<b>PIP</b> -Modus _____	<b>12</b>
Standard-Programm. Ein zuvor eingegebenes Volumen wird aufgenommen und wieder abgegeben	
<b>2. Mischen von Proben</b>	
<b>PIPmix</b> -Modus _____	<b>14</b>
Programm zum Durchmischen von Flüssigkeiten. Probe wird ständig wiederholt aufgesaugt und abgegeben.	
<b>3. Reverses Pipettieren</b>	
<b>revPIP</b> -Modus _____	<b>16</b>
Programm besonders zum Pipettieren von Flüssigkeiten mit hoher Viskosität, hohem Dampfdruck oder schäumenden Medien.	
<b>4. Pipettieren bei Elektrophorese</b>	
<b>GEL</b> -Modus _____	<b>18</b>
Programm zum Beladen von Elektrophorese-Gelen. Ein vorher definiertes Probenvolumen wird bei hoher, veränderbarer Geschwindigkeit aufgesaugt und langsam wieder abgegeben.	
<b>5. Dispensieren</b>	
<b>DISP</b> -Modus _____	<b>20</b>
Programm zum Dispensieren von Flüssigkeiten. Ein aufgenommenes Volumen wird in Teilschritten wieder abgegeben.	

Das Standard-Programm – ein zuvor eingegebenes Volumen wird aufgenommen und wieder abgegeben.  
 Volumen- und Geschwindigkeitseinstellung wie auf Seite 8/9 beschrieben.

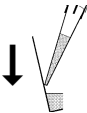
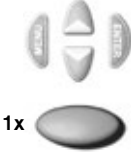
Was muss ich tun?	Wie geht das?	Welche Taste?	Was zeigt das Display?
<b>1. Menü-Selektion aufrufen</b>	Durch dreimaliges Drücken der Menü-Taste gelangt man in die Programm-Selektion. 'Mode' blinkt.	3x 	
<b>2. PIP-Modus einstellen</b>	Mit einer der Pfeiltasten die Modi durchscrollen bis 'PIP' erscheint. 'Mode' blinkt weiterhin.		
<b>3. PIP-Modus bestätigen</b>	Enter-Taste drücken. Das Display zeigt jetzt 'blo' für blow-out (Überhub).	 1x	
<b>4. Vorbereiten zum Pipettieren</b>	Durch einmaliges Drücken der Pipettiertaste werden die Kolben in ihre Startposition gefahren. Der Pfeil im Display zeigt nach oben (Aufnahme).	 1x	
<b>5. Flüssigkeit aufsaugen</b>	Zum Aufsaugen der Flüssigkeit Pipettiertaste einmal drücken.	 1x	





Was muss ich tun?	Wie geht das?	Welche Taste?	Was zeigt das Display?
<p><b>6. Flüssigkeit abgeben</b></p> 	<p>Durch einmaliges Drücken der Pipettiertaste erfolgt die Abgabe der Flüssigkeit. Der Pfeil im Display zeigt nach unten (Abgabe).</p>	 <p>1x</p>	

<p><b>7. Überhub auslösen?</b></p>	<p><b>Sie müssen nichts tun!</b> Beim Pipettieren im PIP-Modus erfolgt der <b>Überhub (blow-out) automatisch!</b></p>		
------------------------------------	---	---	--

## Blow-out direkt auslösen

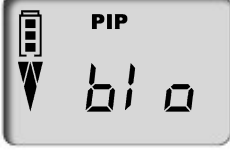
Der Überhub (Blow-out) kann, wenn nötig, jederzeit auch direkt ausgelöst werden.

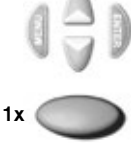













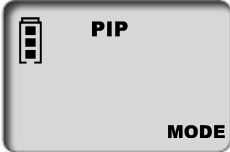













<p><b>1. Blow-out-Funktion aufrufen</b></p>	<p>Enter-Taste drücken. Das Display zeigt 'blo' für blow-out.</p>	 <p>1x</p>	
---	---	--	---

<p><b>2. Überhub auslösen</b></p>	<p>Durch einmaliges Drücken der Pipettiertaste wird der Überhub ausgelöst und das Display springt in den eingestellten Pipettier-Modus (Startposition) zurück.</p>	 <p>1x</p>	
-----------------------------------	--	---	--

**Hinweis:**

Beim Überhub (blow-out) bewegen sich die Kolben vollständig nach unten. Es ist sicherzustellen, dass mögliche Restflüssigkeit gefahrlos abgegeben wird. **Gedrückt halten der Pipettiertaste hält den Kolben unten und verhindert somit ein versehentliches Aufsaugen von Flüssigkeit. Loslassen bewirkt die Rückkehr der Kolben in die Startposition.**

Programm zum Durchmischen von Flüssigkeiten.  
 Probe wird ständig wiederholt aufgesaugt und abgegeben.  
 Volumen- und Geschwindigkeitseinstellung wie auf Seite 8/9 beschrieben.

Was muss ich tun?	Wie geht das?	Welche Taste?	Was zeigt das Display?
<b>1. Menü-Selektion aufrufen</b>	Durch dreimaliges Drücken der Menü-Taste gelangt man in die Programm-Selektion. 'Mode' blinkt.	3x     	
<b>2. PIPmix-Modus einstellen</b>	Mit einer der Pfeiltasten die Modi durchscrollen bis 'PIPmix' erscheint. 'Mode' blinkt weiterhin.	    	
<b>3. PIPmix-Modus bestätigen</b>	Enter-Taste drücken. Das Display zeigt jetzt 'blo' für blow-out (Überhub).	    1x 	
<b>4. Vorbereiten zum Pipettieren</b>	Durch einmaliges Drücken der Pipettiertaste werden die Kolben in ihre Startposition gefahren. Der Pfeil auf dem Display zeigt nach oben (Aufnahme).	    1x 	
<b>5. Flüssigkeit aufsaugen</b>	Zum Aufsaugen der Flüssigkeit Pipettiertaste einmal drücken.	    1x 	

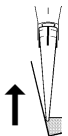



Was muss ich tun?      Wie geht das?      Welche Taste?      Was zeigt das Display?

**6. Flüssigkeit im PIPmix-Modus abgeben**

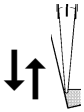

Durch anhaltendes Drücken der Pipettiertaste erfolgt die wechselnde Abgabe und Aufnahme der Flüssigkeit. Im Display werden abwechselnd das Pfeilsymbol für Aufnahme bzw. Abgabe, sowie die Anzahl der Zyklen angezeigt.



**7. Pipettieren beenden**

Durch einmaliges Drücken der Pipettiertaste wird die Flüssigkeit abgegeben und der Überhub (blow-out) ausgelöst.

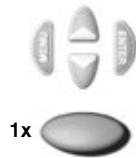







Nach der Abgabe der Restflüssigkeit (Überhub) springt das Display in den eingestellten Modus (Startposition) zurück.

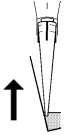
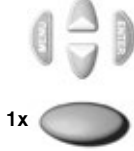













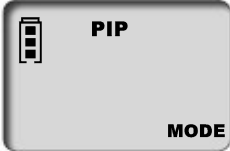



















**Hinweis:** Das Display zeigt maximal 19 Zyklen an.



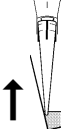

Programm besonders zum Pipettieren von Flüssigkeiten mit hoher Viskosität, Dampfdruck oder schäumenden Medien.  
 Volumen- und Geschwindigkeitseinstellung wie auf Seite 8/9 beschrieben.

Was muss ich tun?	Wie geht das?	Welche Taste?	Was zeigt das Display?
1. Menü-Selektion aufrufen	Durch dreimaliges Drücken der Menü-Taste gelangt man in die Programm-Selektion. 'Mode' blinkt.	3x	
2. revPIP-Modus einstellen	Mit einer der Pfeiltasten die Modi durchscrollen bis 'revPIP' erscheint. 'Mode' blinkt weiterhin.		
3. revPIP-Modus bestätigen	Enter-Taste drücken. Das Display zeigt jetzt 'blo' für blow-out (Überhub).	1x	
4. Vorbereiten zum Pipettieren	Durch einmaliges Drücken der Pipettiertaste werden die Kolben in ihre Startposition gefahren. Der Pfeil im Display zeigt nach oben (Aufnahme).	1x	
5. Flüssigkeit aufsaugen	Pipettiertaste einmal drücken, dabei wird etwas mehr Volumen aufgenommen als eingestellt!	1x	
6. Flüssigkeit im revPIP-Modus abgeben	Zur Abgabe einmal Pipettiertaste drücken. Auf dem Display zeigt der Pfeil nach unten (Abgabe). Jetzt wird das eingestellte Volumen abgegeben und es verbleibt etwas Flüssigkeit in der Spitze.	1x	

Was muss ich tun?	Wie geht das?	Welche Taste?	Was zeigt das Display?
<p>7. Flüssigkeit im revPIP-Modus erneut aufnehmen</p> 	<p>Durch erneutes Drücken der Pipettiertaste wird jetzt das eingestellte Volumen wieder aufgenommen. (Nochmaliges Drücken der Pipettiertaste gibt das Volumen wieder ab, usw.)</p>		
<p>8. Überhub auslösen</p>	<p>Nach der letzten Pipettierung Enter-Taste drücken. Das Display zeigt jetzt wieder 'blo' für blow-out (Überhub).</p>		
	<p>Durch einmaliges Drücken der Pipettiertaste wird der Überhub (blow-out) ausgelöst und die Restflüssigkeit abgegeben.</p>		
<p>9. Pipettieren beenden</p>	<p>Nach der Abgabe der Restflüssigkeit (Überhub) springt das Display in den eingestellten Modus (Startposition) zurück.</p>		

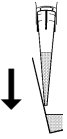
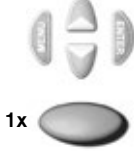
Programm zum Beladen von Elektrophorese-Gelen. Ein vorher definiertes Probenvolumen wird bei hoher, veränderbarer Geschwindigkeit aufgesaugt und langsam wieder abgegeben. Volumen- und Geschwindigkeitseinstellung wie auf Seite 8/9 beschrieben.



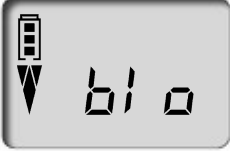
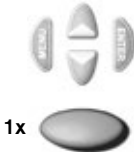





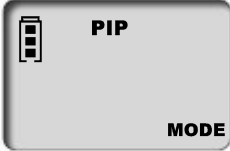

Was muss ich tun?	Wie geht das?	Welche Taste?	Was zeigt das Display?
<b>1. Menü-Selektion aufrufen</b>	Durch dreimaliges Drücken der Menü-Taste gelangt man in die Programm-Selektion. <b>'Mode'</b> blinkt.	3x     	
<b>2. GEL-Modus einstellen</b>	Mit einer der Pfeiltasten Modi durchscrollen bis <b>'GEL'</b> erscheint. <b>'Mode'</b> blinkt weiterhin.	    	
<b>3. GEL-Modus bestätigen</b>	Enter-Taste drücken. Das Display zeigt jetzt <b>'blo'</b> für blow-out (Überhub).	    1x 	
<b>4. Vorbereiten zum Pipettieren</b>	Durch einmaliges Drücken der Pipettiertaste werden die Kolben in ihre Startposition gefahren. Der Pfeil im Display zeigt nach oben (Aufnahme).	    1x 	
<b>5. Flüssigkeit aufnehmen</b>	Zum Aufsaugen der Flüssigkeit Pipettiertaste einmal drücken. Das eingestellte Volumen wird aufgesaugt.	    1x 	
	<b>Höheres Volumen aufnehmen</b> Um mehr Flüssigkeit aufzusaugen als eingestellt (bis max. 110% des Nennvolumens), Pipettiertaste während des Aufsaugvorgangs so lange gedrückt halten, bis gewünschtes Volumen aufgesaugt wurde. Im Display wird eine Raute angezeigt.	     gedrückt halten	

Was muss ich tun?	Wie geht das?	Welche Taste?	Was zeigt das Display?
<p><b>6. Flüssigkeit im GEL-Modus abgeben</b></p> 	<p>Zur Abgabe einmal Pipettiertaste kurz drücken. Im Display wird eine Raute angezeigt. Das aufgenommene Volumen wird langsam wieder abgegeben.</p> <p><b>Abgabe unterbrechen</b></p> <p>Die Abgabe der Probe kann durch nochmaliges Drücken der Pipettiertaste unterbrochen werden. Dabei zeigt das Display das Volumen der abgegebenen Flüssigkeitsmenge an.</p>	 <p>1x</p>	
<p><b>7. Überhub auslösen</b></p>	<p>Nach der letzten Pipettierung Enter-Taste drücken. Das Display zeigt jetzt wieder 'blo' für blow-out (Überhub).</p> <p>Durch einmaliges Drücken der Pipettiertaste wird der Überhub (blow-out) ausgelöst und die Restflüssigkeit abgegeben.</p>	 <p>1x</p>	
<p><b>8. Pipettieren beenden</b></p>	<p>Nach der Abgabe der Restflüssigkeit (Überhub) springt das Display in den eingestellten Modus (Startposition) zurück.</p>	 <p>1x</p>	
			

**Hinweis:**

Der GEL-Modus verlangt sehr langsame Abgabegeschwindigkeiten um Verwirbelungen der Proben vorzubeugen. Um eine optimale Abgabe zu gewährleisten, ist die Abgabegeschwindigkeit werkseitig festgelegt. Sie ist deutlich langsamer als die einstellbare Stufe 1 und individuell nicht anwählbar.

Programm zur Abgabe einer aufgenommenen Flüssigkeit in Teilschritten.  
 Es wird etwas mehr Flüssigkeit aufgenommen als rechnerisch nötig.  
 Geschwindigkeitseinstellung wie auf Seite 9 beschrieben.

Was muss ich tun?	Wie geht das?	Welche Taste?	Was zeigt das Display?
1. Menü-Selektion aufrufen	Durch dreimaliges Drücken der Menü-Taste gelangt man in die Programm-Selektion. 'Mode' blinkt.	3x 	
2. DISP-Modus einstellen	Mit einer der Pfeiltasten die Modi durchscrollen bis 'DISP' erscheint. 'Mode' blinkt weiterhin.		
3. DISP-Modus bestätigen	Enter-Taste drücken. Das Display zeigt jetzt 'blo' für blow-out (Überhub).	 1x	
4. Vorbereiten zum Dispensieren	Durch einmaliges Drücken der Pipettiertaste werden die Kolben in ihre Startposition gefahren. Der Pfeil im Display zeigt nach oben (Aufnahme).	 1x	
5. Teilvolumen einstellen	Durch Drücken der Pfeiltaste (+/-) wird das Volumen eingestellt. Anhaltendes Drücken der Pfeiltaste führt zur schnellen Volumenveränderung. 'VOL' blinkt.		
6. Teilvolumen bestätigen	Enter-Taste drücken. Das Display zeigt das neu eingestellte Teilvolumen an. 'steps' blinkt. Es wird die maximal mögliche Anzahl der Steps angezeigt.	 1x	

Was muss ich tun?	Wie geht das?	Welche Taste?	Was zeigt das Display?
<b>7. Anzahl Steps einstellen</b>	Durch Drücken der Pfeiltaste (+/-) wird die Anzahl der Steps eingestellt. 'steps' blinkt weiterhin.		
<b>8. Anzahl Steps bestätigen</b>	Enter-Taste drücken. Das Display zeigt die eingestellte Anzahl der Steps an.		
<b>9. Flüssigkeit aufsaugen</b>	Zum Aufsaugen der Flüssigkeit Pipettiertaste einmal drücken.		
<b>10. Flüssigkeit abgeben</b>	Mit jedem Betätigen der Pipettiertaste erfolgt ein Dispensierschritt. Der Pfeil im Display zeigt nach unten (Abgabe). Die Step-Anzeige zeigt die Anzahl der verbleibenden Schritte.		
<b>11. Überhub auslösen</b>	Nach dem letzten Dispensierschritt Enter-Taste drücken. Das Display zeigt 'blo' für blow-out (Überhub). Anschließendes einmaliges Drücken der Pipettiertaste löst Überhub aus (s. auch S. 19).		
<b>12. Dispensieren beenden</b>	Nach der Abgabe der Restflüssigkeit (Überhub) springt das Display in den eingestellten Modus (Startposition) zurück.		

# Volumen kontrollieren

Wir empfehlen, je nach Einsatz, alle 3-12 Monate eine Prüfung des Gerätes. Der Zyklus kann aber den individuellen Anforderungen angepasst werden.

Die gravimetrische Volumenprüfung der Pipette erfolgt durch nachfolgende Schritte und entspricht der DIN EN ISO 8655, Teil 6.

## 1. Nennvolumen einstellen

Maximales angegebenes Gerätevolumen einstellen.  
Vorgehensweise siehe Seite 8.

## 2. Pipette konditionieren

Pipette vor der Prüfung konditionieren, indem mit Pipettenspitzen fünfmal die Prüflüssigkeit (H<sub>2</sub>O dest.) aufgenommen und abgegeben wird. Danach die Pipettenspitzen abwerfen.

## 3. Prüfung durchführen

- Neue Pipettenspitzen aufstecken und einmal mit Prüflüssigkeit vorspülen.
- Prüflüssigkeit aufnehmen und in das Wägegefäß pipettieren.

**Hinweis:** Jeder einzelne Kanal muss separat überprüft werden.

- Pipettierte Menge mit einer Analysenwaage wägen. (Beachten Sie bitte die Gebrauchsanleitung des Waagenherstellers.)
- Pipettiertes Volumen berechnen. Dabei die Temperatur berücksichtigen.
- 3-10 Pipettierungen und Wägungen pro Kanal in 3 Volumenbereichen (100 %, 50 %, 10 %) werden empfohlen.

### Berechnung (für Nennvolumen)

$x_i$  = Wäge-Ergebnisse  
 $n$  = Anzahl der Wägungen

$Z$  = Korrekturfaktor  
(z. B. 1,0029 µl/mg bei 20 °C, 1013 hPa)

Mittelwert  $\bar{x} = \frac{\sum x_i}{n}$

Mittleres Volumen  $\bar{V} = \bar{x} \cdot Z$

### Richtigkeit\*

$$R\% = \frac{\bar{V} - V_0}{V_0} \cdot 100$$

$V_0$  = Nennvolumen

### Standardabweichung

$$s = Z \cdot \sqrt{\frac{\sum (x_i - \bar{x})^2}{n - 1}}$$

### Variationskoeffizient\*

$$VK\% = \frac{100 s}{\bar{V}}$$

\*) = Berechnung von Richtigkeit (R%) und Variationskoeffizient (VK%):  
R% und VK% werden nach den Formeln der statistischen Qualitätskontrolle berechnet.



Endprüfwerte bezogen auf das auf dem Gerät aufgedruckte Nennvolumen (= max. Volumen) und die angegebenen Teilvolumina bei gleicher Temperatur (20 °C) von Gerät, Umgebung und aqua dest. Gemäß der DIN EN ISO 8655.

CE



20 °C  
Ex

## Genauigkeitswerte der Transferpette®-8/-12 electronic

Volumenbereich µl	Teilvolumen µl	R* ≤ ± %	VK* ≤ %	Teilschritte µl	Empfohlener Spitzentyp, µl
0,5 - 10	10	1,2	0,8	0,01	0,5 - 20
	5	2,0	1,5		
	1	8,0	4,0		
1 - 20	20	1,0	0,5	0,02	0,5 - 20
	10	2,0	1,0		
	2	8,0	3,0		
5 - 100	100	0,8	0,25	0,1	2 - 200
	50	1,6	0,4		
	10	4,0	1,5		
10 - 200	200	0,8	0,25	0,2	2 - 200
	100	1,4	0,4		
	20	4,0	1,3		
15 - 300	300	0,6	0,25	0,5	5 - 300
	150	1,2	0,4		
	30	3,0	1,2		

\* R = Richtigkeit, VK = Variationskoeffizient

### Hinweis:

Prüfanweisungen (SOPs) und eine Demoversion der Kalibriersoftware EASYCAL™ 4.0 stehen unter [www.brand.de](http://www.brand.de) zum Download bereit.

## Der Justier-Modus 'CAL'

### Justieren

Das Nennvolumen bzw. zu prüfendes Volumen ist eingestellt, Standard-Modus Pipettieren (PIP), z. B. 100,0 µl (Vorgehensweise siehe Seite 8, 12).  
Bsp.: Volumen entsprechend Volumenprüfung 101,3 µl.



Was muss ich tun?	Wie geht das?	Welche Taste?	Was zeigt das Display?
-------------------	---------------	---------------	------------------------

### 1. CAL-Modus aufrufen

Durch anhaltendes Drücken (> 3 Sek.) der Menü-Taste wird der CAL-Modus aufgerufen. Die Anzeige zeigt 'off'. 'CAL' blinkt.

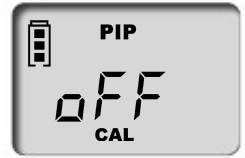

### 2. CAL-Modus aktivieren

Durch Drücken einer der Pfeiltasten wird der CAL-Modus aktiviert. Die Anzeige wechselt von 'off' auf 'on'. 'CAL' blinkt weiterhin.

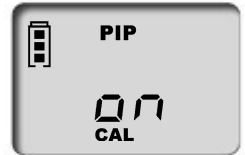

### 3. CAL-Modus bestätigen

Enter-Taste drücken. Das Display zeigt jetzt wieder das eingestellte Pipettiervolumen. 'CAL' blinkt.



### 4. Volumen einstellen

Mit den Pfeiltasten (+/-) das vorher ermittelte und geprüfte Volumen einstellen. 'CAL' blinkt.

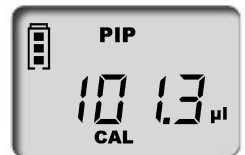

### 5. Volumen bestätigen

Enter-Taste drücken. Im Display erscheint das geprüfte und korrigierte Volumen. Das jetzt ständig angezeigte CAL-Symbol belegt die vorgenommene Justierung.



## Werkzustand wieder herstellen

Das ständig angezeigte CAL-Symbol im Display weist auf eine vorgenommene Justierung hin.



**Was muss ich tun?**

**Wie geht das?**

**Welche Taste?**

**Was zeigt das Display?**

### 1. CAL-Modus aufrufen

Durch anhaltendes Drücken (> 3 Sek.) der Menü-Taste wird der CAL-Modus aufgerufen. Die Anzeige zeigt 'on'. 'CAL' blinkt.

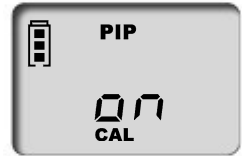
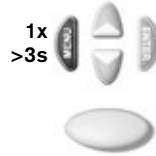

### 2. CAL-Modus ausschalten

Durch Drücken einer der Pfeiltasten wird der CAL-Modus deaktiviert. Die Anzeige wechselt von 'on' auf 'off'. 'CAL' blinkt weiterhin.



### 3. Werkzustand herstellen

Enter-Taste drücken. Das ständig angezeigte CAL-Symbol ist verschwunden. Das Gerät befindet sich wieder im Werkzustand.



## Wichtig:

Bei der Transferpette®-8/-12 electronic wird beim Justieren ein Volumen-Offset vorgenommen, d. h. das Volumen ändert sich über den gesamten Volumenbereich der Pipette um den gleichen Betrag. Es wird empfohlen, die Justierung bei 50 % des Nennvolumens durchzuführen.

## Hinweis:

Das Gerät ist permanent justiert für wässrige Lösungen, kann aber auch auf Lösungen unterschiedlicher Dichte, Viskosität und Temperatur eingestellt werden. Die Transferpette®-8/-12 electronic kann in jedem Modus justiert werden (Ausnahme GEL-Modus).

# Autoklavieren

Die hervorgehobene abgebildete Pipettiereinheit (P) der Transferpette®-8/-12 electronic ist autoklavierbar bei 121 °C (2 bar) und einer Haltezeit von mindestens 15 Minuten nach DIN EN 285.

**Achtung:** Das Griffteil ist nicht autoklavierbar!

1. Pipettenspitzen abwerfen.
2. Pipettenschaft vom Griffteil trennen (siehe S. 28).
3. Ohne weitere Demontage komplette Pipettiereinheit autoklavieren.
4. Pipettiereinheit vollständig abkühlen und trocknen lassen.
5. Pipettiereinheit wieder in das Griffteil schrauben (siehe S. 28).
6. Referenzfahrt (rEF) durchführen.

**Hinweis:** Die Wirksamkeit des Autoklavierens ist vom Anwender selbst zu prüfen.  
Höchste Sicherheit wird durch Vakuumsterilisation erreicht. Wir empfehlen die Verwendung von Sterilisationsbeuteln.

Bei häufigem Autoklavieren der Pipettiereinheit sollten die Kolben zur besseren Gängigkeit mit dem mitgelieferten Silikonfett gefettet werden.

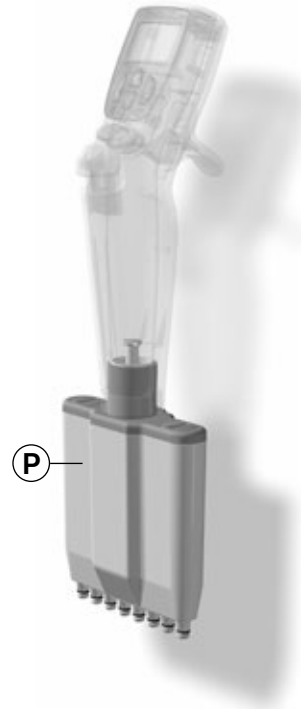

## Referenzfahrt (rEF)

Nach jedem Wechsel der Pipettiereinheit ist eine manuelle Referenzfahrt durchzuführen. Die Referenzfahrt dient zur sicheren Ankopplung der Kolben.

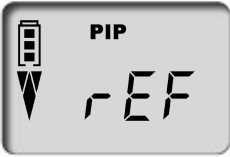
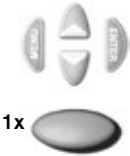
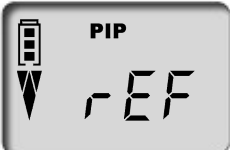
Was muss ich tun?	Wie geht das?	Welche Taste?	Was zeigt das Display?
1. rEF-Modus aufrufen	Durch gleichzeitiges Drücken der Menü- und der Enter-Taste wird der rEF-Modus aktiviert.		
2. Referenzfahrt durchführen	Durch einmaliges Drücken der Pipettiertaste wird die Referenzfahrt ausgelöst. Ein deutliches Funktionsgeräusch ist vernehmbar.		

**Hinweis:** Nach der Referenzfahrt schaltet das Display automatisch in das vorher eingestellte Programm zurück.

Zur Wartung, Reinigung oder Teileaustausch lassen sich die drei Hauptkomponenten der Pipettiereinheit leicht trennen und zerlegen. Die Vorgehensweise ist auf den folgenden Seiten anschaulich erklärt.

**Hinweis:** Der Wechsel der O-Ringe an den Einzelschäften wird detailliert in der beim Ersatzteil beiliegenden Anleitung beschrieben.

## Die Hauptkomponenten der Pipettiereinheit (P)

- A Kolbeneinheit** mit Kolbenlagerbalken [I] und den darin eingesetzten Kolben, die zur Reinigung oder zum Austausch einzeln ausgeschraubt werden können.
- B Schafteinheit** mit Schaftlagerbalken [II] und der daran befestigten zentralen Führungssachse (Z), sowie den Schäften und Dichtungen, die zur Reinigung oder zum Austausch einzeln ausgeschraubt werden können.
- C Pipettiergehäuse**, das mit zwei Drehverschlüssen mit der Pipettiergehäuseabdeckung [III] der Kolbeneinheit verbunden ist.

## Wartung

Die Transferpette®-8/-12 electronic sollte, um eine einwandfreie Funktion zu gewährleisten, in regelmäßigen Abständen gewartet und ggf. gereinigt werden.

### Was ist zu prüfen?

1. Pipettenschäfte, Kolben und Dichtungen auf Beschädigung und Verschmutzung prüfen.
2. Dichtheit des Geräts prüfen. Wir empfehlen das BRAND Dichtheitsprüfgerät BRAND PLT unit zu verwenden. Alternativ dazu Probe aufsaugen, Gerät ca. 10 s senkrecht halten. Falls sich an den Pipettenspitzen Tropfen bilden: Störungen – was tun?, Seite 34.

### Hinweise zur Reinigung (S. 28-31)

1. Einzelschäfte, Kolben und Schaft-/Kolbenlagerbalken (**nur diese Teile**) mit Seifenlösung oder Isopropanol reinigen, anschließend mit aqua dest. spülen.
2. Teile vollständig trocknen und abkühlen lassen. Flüssigkeitsreste in den Schäften führen zu Genauigkeitsabweichungen.
3. Kolben hauchdünn mit dem mitgelieferten Silikonfett nachfetten. Für die zentrale Führungssachse (Z) nur das vorgeschriebene Fluorstaticfett verwenden!
4. Nach dem Zusammenbau des Geräts eine Referenzfahrt (rEF) durchführen.

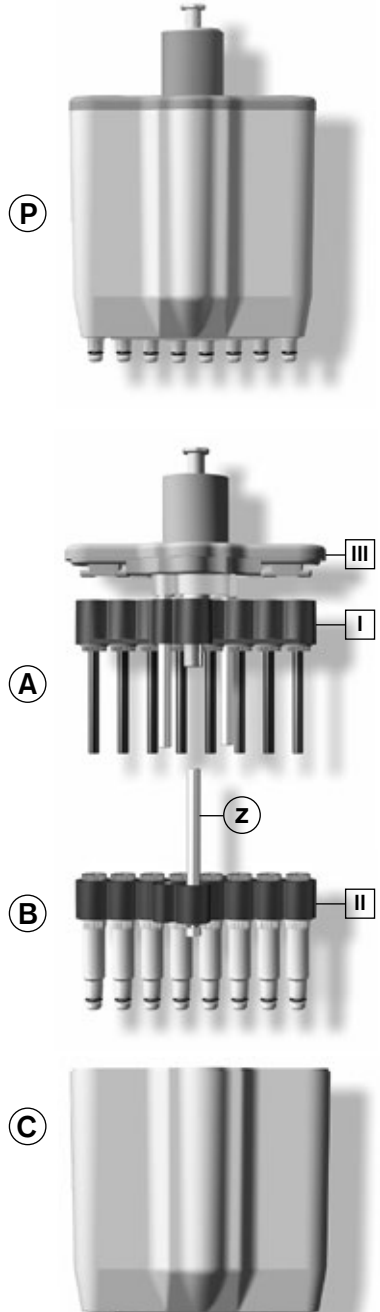

# Wartung und Reinigung

## Trennung Pipettiereinheit vom Griffteil

1. Pipettenspitzen abwerfen.
2. Zur Entkoppelung die Pipettiereinheit so weit wie möglich nach unten ziehen, **erst danach** im Uhrzeigersinn drehen.  
Nach einer Umdrehung muss beim Drehen nicht mehr nach unten gezogen werden.
3. Ist die Pipettiereinheit abgeschraubt, muss sie nochmals nach unten gezogen werden, um die magnetische Kopplung zu trennen.

### Hinweis:

Beim Montieren muss die Pipettiereinheit gegen den Uhrzeigersinn so auf das Griffteil geschraubt werden, dass sie hörbar einrastet. Die Pipettiereinheit beim Montieren nicht nach unten ziehen!

### Achtung:

Unsachgemäße Behandlung kann zur Beschädigung führen!



## Entfernen von Schäften und Dichtungen zur Reinigung oder zum Austausch

1. **Pipettiereinheit abschrauben** Pipettiereinheit vom Griffteil trennen.

2. **Pipettiergehäuse abziehen** Beide Verschlüsse der Pipettiergehäuseabdeckung um 90° drehen und Pipettiergehäuse abziehen.

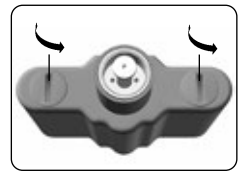

3. **Schaft abschrauben** Montageschlüssel auf Einzelschaft stecken und den Schaft abschrauben.

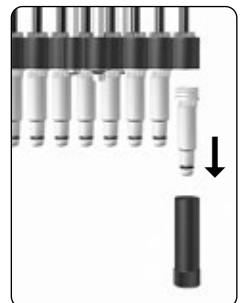

## 4. Dichtung entfernen

Kolbeneinheit ganz nach unten schieben. Dichtung entfernen, überprüfen und ggf. reinigen oder auswechseln

### Hinweis:

Die Dichtung befindet sich nach dem Entfernen des Schaftes entweder im Schaft oder auf dem Kolben.

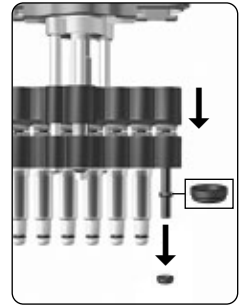

## 5. Dichtung montieren

Bei Bedarf Kolben mit dem mitgelieferten Silikonfett leicht nachfetten. Dichtung mit der flachen Seite nach oben auf den Kolben schieben. Gereinigten oder neuen Schaft mit dem Montageschlüssel festschrauben.

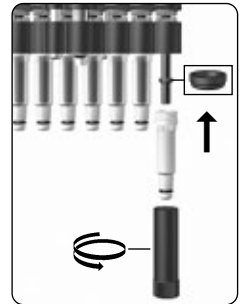

## 6. Pipettiereinheit zusammenbauen

Pipettiereinheit wieder zusammenbauen und am Griffteil montieren.

### Hinweis:

Die Pipettiereinheit muss gegen den Uhrzeigersinn so auf das Griffteil geschraubt werden, dass sie hörbar einrastet.

Die Pipettiereinheit dabei nicht nach unten ziehen!

Gerät auf Dichtheit, Gängigkeit und Genauigkeit prüfen (siehe S. 27 "Wartung").

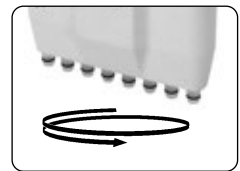

## 7. Referenzfahrt durchführen

Referenzfahrt (rEF) durchführen.

# Wartung und Reinigung

## Entfernen von Kolben zur Reinigung oder zum Austausch

### 1. Pipettiereinheit abschrauben

Pipettiereinheit vom Griffteil trennen (siehe S. 28).

### 2. Pipettiergehäuse abziehen

Beide Verschlüsse der Pipettiergehäuse-abdeckung um 90° drehen und Pipettiergehäuse abziehen.

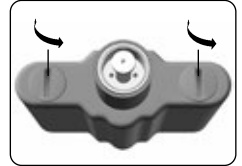

### 3. Schrauben entfernen

Die beiden äußeren Kreuzschlitz-Schrauben an der Schafteinheit entfernen.

**Achtung:**

Die zentrale Führungssachse (Z) darf nicht gelöst werden!

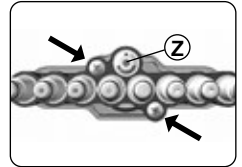

### 4. Kolben- und Schafteinheit trennen

Kolben- und Schafteinheit auseinanderziehen und trennen.

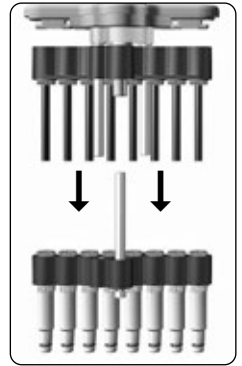

### 5. Kolben entfernen

Montageschlüssel auf Kolbenmutter stecken und Kolbenmutter abschrauben. Kolbenmutter entfernen und Kolben herausziehen.

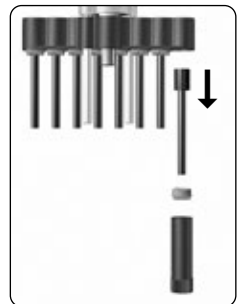



## 6. Kolben montieren

Gereinigten oder neuen Kolben einsetzen. Kolbenmutter mit Montageschlüssel wieder festschrauben.

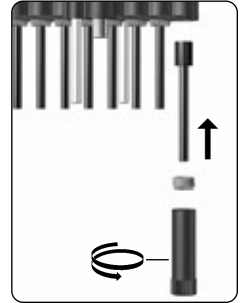

## 7. Kolben- und Schafteinheit zusammenbauen

Schäfte um eine halbe Umdrehung lockern. Anschließend die Schafteinheit auf die Kolbeneinheit aufstecken und befestigen. Danach die Schäfte anschrauben.

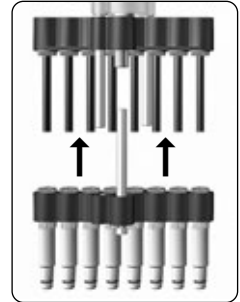

## 8. Pipettiereinheit zusammenbauen

Pipettiereinheit wieder zusammenbauen und am Griffteil montieren.

### Hinweis:

Die Pipettiereinheit muss gegen den Uhrzeigersinn so auf das Griffteil geschraubt werden, dass sie hörbar einrastet. Die Pipettiereinheit dabei nicht nach unten ziehen.

Gerät auf Dichtheit, Gängigkeit und Genauigkeit prüfen (siehe S. 27 "Wartung").

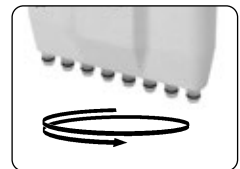

## 9. Referenzfahrt durchführen

Referenzfahrt (rEF) durchführen.

# Akku laden und wechseln

Ein vollständig geladener Akku erlaubt ca. 8 h Dauerpipettieren von Proben wasserähnlicher Viskosität und Dichte.

## Achtung!

Vor dem Laden ist sicherzustellen, dass das Netzteil für die im Labor vorhandene Spannung geeignet ist. Das Gerät darf nicht in explosionsgefährdeter Umgebung geladen werden. Der Akku kann ausschließlich in der Transferpette®-8/-12 electronic geladen werden!

### Akku nachladen

- a) Ladekabelstecker des Netzteils in die dafür vorgesehene Buchse oben an der Transferpette®-8/-12 electronic stecken. Der Ladevorgang startet automatisch.
- b) Während des Ladevorgangs laufen die Balken der Akku-Kapazitätsanzeige ständig von unten nach oben. Der Akku ist vollständig geladen, wenn die Balken der Anzeige zum Stillstand gekommen sind.



### Pipettieren während des Ladevorgangs?

Während des Ladens kann mit der Transferpette®-8/-12 electronic weiter gearbeitet werden. Bei vollständig entlademem Akku dauert es einige Minuten bis eine bestimmte Mindestladekapazität erreicht ist, die zum sicheren Betrieb des Geräts notwendig ist.

**Hinweis:** Die zuletzt vorgenommenen Einstellungen werden im EEPROM des Geräts gespeichert. Bei kompletter Entladung oder beim Wechsel des Akkus bleiben diese Einstellungen gesichert!

### Akku auswechseln

- a) Deckel des Akku-Fachs öffnen, Akku entnehmen und Stecker aus der Steckbuchse ziehen.
- b) Stecker von neuem Akku in die Steckbuchse stecken und neuen Akku einlegen.
- c) Deckel des Akku-Fachs wieder einsetzen und verschließen.



Bei längeren Betriebspausen Akku aus dem Gerät entfernen.

## Batterieanzeige nach erneutem Einsetzen eines Akkus

- a) Nach dem Einsetzen eines Akkus erscheint **im Display die volle Kapazitätsanzeige** mit blinkendem Rahmen (das Gerät erkennt den Ladezustand zunächst noch nicht). Nach 3,5 h Ladezeit – sicheres vollständiges Laden des Akkus – hört der Rahmen auf zu blinken.



### Hinweis:

Nach dem Einsetzen eines Akkus immer 3,5 h laden!  
Die vollständige Ladekapazität wird nach mehreren Lade-/Entladezyklen erreicht!

## Akku-Regenerationsfunktion

### (Refresh-Funktion)

Zur Verlängerung der Lebensdauer und zur Leistungssteigerung der Akkus verfügt die Transferpette® -8/-12 electronic über eine Regenerationsfunktion (Refresh-Funktion). Diese Funktion ermöglicht es, die Akkus programmgesteuert vollständig ent- und wieder aufzuladen. Zur Optimierung der Leistungsfähigkeit der Akkus sollte die Refresh-Funktion von Zeit zu Zeit angewendet werden.

### Refresh-Funktion durchführen

- a) Ladekabelstecker (Anschluss) des Netzteils in die dafür vorgesehene Buchse oben an der Transferpette®-8/-12 electronic stecken.



- b) Untere Pfeiltaste länger als 3 s drücken. Während des Entladens laufen die Kapazitätsbalken der Batterieanzeige ständig von oben nach unten.



- c) Nach dem Entladen (bis 3 h) wird automatisch der Ladevorgang (3,5 h) gestartet. Während des Ladens laufen die Kapazitätsbalken der Batterieanzeige ständig von unten nach oben.







### Abbruch der Refresh-Funktion

Durch Drücken einer beliebigen Taste wird das Programm beendet. Das Gerät schaltet automatisch in den Standard-Pipettiermodus (PIP) und auf das Nennvolumen zurück und der normale Ladevorgang wird automatisch gestartet (s. Seite 32). Ziehen des Netzteilsteckers beendet das Programm ebenfalls. Der Abbruch der Refresh-Funktion darf nicht am Ende des Entladezyklus vorgenommen werden.

# Störung – was tun?

Beim Auftreten eines Fehlers zeigt das Gerät im Display 'Err' und die Fehlernummer an. Das Gerät reagiert dann nur noch auf die Enter-Taste. Durch Betätigen der Enter-Taste wird versucht, das Gerät neu zu starten. Es wird daher automatisch eine Referenzfahrt (rEF) angefordert.

Störung	Error-Anzeige im Display	Mögliche Ursache	Was tun?
Gerät reagiert nicht		Akku leer oder defekt	Akku mind. 5 min ohne Betätigung laden, dann nur mit Ladekabel weiterarbeiten bis Akku nachgeladen ist, ggf. Akku austauschen
		elektronische Bauteile defekt	Gerät zur Reparatur einsenden
Gerät reagiert nicht		elektronische Bauteile defekt	Gerät zur Reparatur einsenden
Gerät reagiert nicht		unvorhergesehener Programmfehler	Fehlerbestätigung durch Betätigen der Enter-Taste, Gerät wird neu initialisiert
Gerät reagiert nicht		elektronische Bauteile defekt	Gerät zur Reparatur einsenden
Keine Anzeige im Display	—	elektrostatische Entladung	Akku entfernen und erneut einsetzen
		elektronische Bauteile defekt	Gerät zur Reparatur einsenden
Spitze tropft/ Gerät undicht oder Volumenfehler	—	ungeeignete Spitze	nur Qualitätsspitzen verwenden
		Spitze sitzt nicht fest	Spitze fester aufdrücken
		Kolben, Schaft oder Dichtung verschmutzt oder beschädigt	Gerät reinigen/ Dichtung ersetzen Kolben fetten
Flüssigkeit wird nicht aufgesaugt oder starkes Motorengeräusch	—	Kolbengängigkeit eingeschränkt	Pipettiereinheit abschrauben und mittiges Metallteil von Hand bewegen

Kennzeichnung	Bedeutung
	Mit diesem Zeichen bestätigen wir, dass das Produkt den in den EG-Richtlinien festgelegten Anforderungen entspricht und den festgelegten Prüfverfahren unterzogen wurde.
	Das Gerät ist gemäß deutschem Mess- und Eichgesetz sowie der Mess- und Eichverordnung gekennzeichnet. Zeichenfolge DE-M (DE für Deutschland), eingerahmt durch ein Rechteck, sowie die beiden letzten Ziffern des Jahres, in dem die Kennzeichnung angebracht wurde (hier: 2020).
XXZXXXXX	Seriennummer
	Beachten Sie die gegebenen Hinweise am Gerät, den Zubehörteilen und in der Gebrauchsanleitung.
	Das Gerät oder der Akku soll fachgerecht entsorgt werden.
	Gebrauchsanleitung lesen.
	China RoHS (EFUP) EFUP definiert den Zeitraum in Jahren, in dem die in Elektro- und Elektronikgeräten enthaltenen gefährlichen Stoffe unter normalen Betriebsbedingungen nicht auslaufen oder mutieren. Bei normalem Gebrauch durch den Benutzer führen solche Elektro- und Elektronikprodukte nicht zu einer schweren Umweltverschmutzung, zu schweren Körperverletzungen oder zur Beschädigung der Sachwerte des Benutzers.
	Das elektrische Gerät darf nicht mit dem Hausmüll entsorgt werden.

### Transferpette®-8 electronic inkl. Netzteil (100-240V/50-60 Hz)

Volumen	0,5-10 µl	1-20 µl	5-100 µl	10-200 µl	15-300 µl
	Best.-Nr.	Best.-Nr.	Best.-Nr.	Best.-Nr.	Best.-Nr.
für Europa (Kontinent)	7053 99	7054 00	7054 03	7054 04	7054 06
für UK/Irland	7054 09	7054 10	7054 13	7054 14	7054 16
für USA/Japan	7054 19	7054 20	7054 23	7054 24	7054 26
für Australien	7054 29	7054 30	7054 33	7054 34	7054 36

### Transferpette®-12 electronic inkl. Netzteil (100-240V/50-60 Hz)

Volumen	0,5-10 µl	1-20 µl	5-100 µl	10-200 µl	15-300 µl
	Best.-Nr.	Best.-Nr.	Best.-Nr.	Best.-Nr.	Best.-Nr.
für Europa (Kontinent)	7054 49	7054 50	7054 53	7054 54	7054 56
für UK/Irland	7054 59	7054 60	7054 63	7054 64	7054 66
für USA/Japan	7054 69	7054 70	7054 73	7054 74	7054 76
für Australien	7054 79	7054 80	7054 83	7054 84	7054 86

### Netzteile (100-240V/50-60 Hz)

Beschreibung	Best.-Nr.
für Europa (Kontinent)	7053 50
für UK/Irland	7053 51
für USA/Japan	7053 52
für Australien	7053 53

**Ersatzteile Transferpette®-8/-12 electronic**

Design und Abmessungen der Ersatzteile entsprechend dem jeweiligen Nennvolumen (Abb. Ersatzteile Transferpette®-8/-12 electronic 5-100 µl).

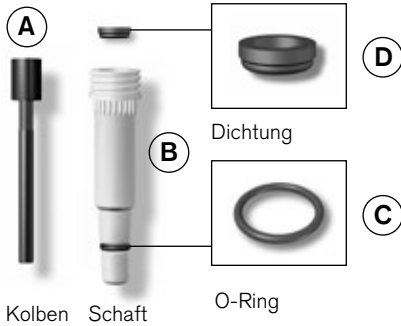

Volumen	A	B*	C	D
0,5 - 10 µl	7056 59	7056 77	7033 80	7033 40
1 - 20 µl	7056 71	7056 78	7033 80	7033 41
5 - 100 µl	7056 62	7056 15	7056 18	7033 44
10 - 200 µl	7056 63	7056 16	7056 18	7033 45
15 - 300 µl	7056 64	7056 17	7056 18	7033 46

\* inkl. Dichtung, O-Ring und Montageschlüssel.

**Qualitäts-Pipettenspitzen von BRAND,**  
palettiert, in TipBox

Volumen	Anzahl Spitzen	Best.-Nr.
0,1 - 20 µl	480	7322 02
0,5 - 20 µl	480	7322 04
2 - 200 µl	480	7322 08
5 - 300 µl	480	7322 10

**Weiteres Zubehör**

Beschreibung	Best.-Nr.
Ersatz-Akku	7055 00
Silikonfett	7036 77
Fluorstatikfett	7036 78
PLT unit	7039 70

## Zur Reparatur einsenden

**Achtung!** Der Transport von gefährlichem Material ohne Genehmigung ist gesetzlich verboten.

- Gerät gründlich reinigen und dekontaminieren!
- Fügen Sie der Rücksendung von Produkten bitte grundsätzlich eine genaue Beschreibung der Art der Störung und der verwendeten Medien bei. Bei fehlender Angabe der verwendeten Medien kann das Gerät nicht repariert werden.
- Der Rücktransport geschieht auf Gefahr und Kosten des Einsenders.

## Außerhalb der USA und Kanada:

- "Erklärung zur gesundheitlichen Unbedenklichkeit" ausfüllen und gemeinsam mit dem Gerät an Hersteller oder Händler senden. Vordrucke können beim Händler oder Hersteller angefordert werden, bzw. stehen unter [www.brand.de](http://www.brand.de) zum Download bereit.

## In den USA und Kanada:

- Bitte klären Sie mit BrandTech Scientific, Inc. die Voraussetzungen für die Rücksendung **bevor** Sie das Gerät zum Service einschicken.
- Senden Sie ausschließlich gereinigte und dekontaminierte Geräte an die Adresse, die Sie zusammen mit der Rücksendenummer erhalten haben. Die Rücksendenummer außen am Paket gut sichtbar anbringen.

## Kontaktadressen

### BRAND GMBH + CO KG

Otto-Schott-Straße 25  
97877 Wertheim (Germany)  
Tel.: +49 9342 808-0  
Fax: +49 9342 808-98000  
E-Mail: [info@brand.de](mailto:info@brand.de)  
[www.brand.de](http://www.brand.de)

### USA und Kanada:

BrandTech® Scientific, Inc.  
11 Bokum Road  
Essex, CT 06426-1506 (USA)  
Tel.: +1-860-767 2562  
Fax: +1-860-767 2563  
[www.brandtech.com](http://www.brandtech.com)

### Indien:

BRAND Scientific Equipment Pvt. Ltd.  
303, 3rd Floor, 'C' Wing, Delphi  
Hiranandani Business Park, Powai  
Mumbai - 400 076 (India)  
Tel.: +91 22 42957790  
Fax: +91 22 42957791  
E-Mail: [info@brand.co.in](mailto:info@brand.co.in)  
[www.brand.co.in](http://www.brand.co.in)

### China:

BRAND (Shanghai) Trading Co., Ltd.  
Guangqi Culture Plaza  
Room 506, Building B  
No. 2899, Xietu Road  
Shanghai 200030 (P.R. China)  
Tel.: +86 21 6422 2318  
Fax: +86 21 6422 2268  
E-Mail: [info@brand.cn.com](mailto:info@brand.cn.com)  
[www.brand.cn.com](http://www.brand.cn.com)



### Kalibrierservice

Die ISO 9001 und GLP-Richtlinien fordern die regelmäßige Überprüfung Ihrer Volumenmessgeräte. Wir empfehlen, alle 3-12 Monate eine Volumenkontrolle vorzunehmen. Der Zyklus ist abhängig von den individuellen Anforderungen an das Gerät. Bei hoher Gebrauchshäufigkeit oder aggressiven Medien sollte häufiger geprüft werden. Die ausführliche Prüfanweisung steht unter [www.brand.de](http://www.brand.de) bzw. [www.brandtech.com](http://www.brandtech.com) zum Download bereit.

BRAND bietet Ihnen darüber hinaus die Möglichkeit, Ihre Geräte durch unseren Werks-Kalibrierservice oder durch das BRAND-DAkkS-Labor kalibrieren zu lassen.

Schicken Sie uns einfach die zu kalibrierenden Geräte mit der Angabe, welche Art der Kalibrierung Sie wünschen. Sie erhalten die Geräte nach wenigen Tagen zusammen mit einem Prüfbericht (Werkskalibrierung) bzw. mit einem DAkkS-Kalibrierschein zurück. Nähere Informationen erhalten Sie von Ihrem Fachhändler oder direkt von BRAND.

Die Bestellunterlage steht unter [www.brand.de](http://www.brand.de) zum Download bereit (s. Technische Unterlagen).

## Mängelhaftung

Wir haften nicht für Folgen unsachgemäßer Behandlung, Verwendung, Wartung, Bedienung oder nicht autorisierter Reparatur des Gerätes oder für Folgen normaler Abnutzung, insbesondere von Verschleißteilen wie z.B. Kolben, Dichtungen, Ventilen sowie bei Glasbruch. Gleiches gilt für die Nichtbeachtung der Gebrauchsanleitung. Insbesondere übernehmen wir keine Haftung für entstandene Schäden, wenn das Gerät weiter zerlegt wurde als in der Gebrauchsanleitung beschrieben oder wenn fremde Zubehör- bzw. Ersatzteile eingebaut wurden.

USA und Kanada:

Informationen zur Mängelhaftung finden Sie unter [www.brandtech.com](http://www.brandtech.com).

## Entsorgung

---

Das nebenstehende Symbol bedeutet, dass Batterien/Akkus und elektronische Geräte am Ende ihrer Lebensdauer vom Hausmüll (unsortierter Siedlungsabfall) getrennt entsorgt werden müssen.

- Elektronische Geräte müssen gemäß der Richtlinie 2002/96/EG des europäischen Parlaments und des Rates vom 27. Januar 2003 über Elektro- und Elektronik-Altgeräte fachgerecht entsprechend den nationalen Entsorgungsvorschriften entsorgt werden.
- Batterien und Akkus enthalten Stoffe, die sich schädlich auf die Umwelt und die menschliche Gesundheit auswirken können. Sie müssen daher gemäß der Richtlinie 2006/66/EG des europäischen Parlaments und des Rates vom 06. September 2006 über Batterien und Akkumulatoren fachgerecht entsprechend den nationalen Entsorgungsvorschriften entsorgt werden. Nur vollständig entladene Batterien und Akkus entsorgen.



### **Warnung!**

Batterien und Akkus zum Entladen nicht kurzschließen!

	Page
Safety Instructions	42
Functions and Limitations of Use	43
Operating Exclusions	43
<b>Operating Elements</b>	<b>44</b>
The First Steps	45
Setting the Volume	46
Setting the Aspiration and Discharging Speed	47
Correct Pipetting	48
The Pipetting Programs	49
<b>PIP mode</b>	<b>50</b>
<b>PIPmix mode</b>	<b>52</b>
<b>revPIP mode</b>	<b>54</b>
<b>Electrophoresis (GEL) mode</b>	<b>56</b>
<b>DISP mode</b>	<b>58</b>
Checking the Volume	60
Accuracy Table	61
<b>Easy Calibration (adjustment)</b>	<b>62</b>
Autoclaving	64
Reference Run (rEF)	64
Servicing and Cleaning	65
Charging and Replacing the Battery	70
Battery Regeneration Function	71
Troubleshooting	72
Product Markings	73
Ordering Information · Accessories · Spare Parts	74
Repairs · Contact addresses	76
Calibration Service · Warranty Information	77
Disposal	78

## Safety Instructions

This instrument may sometimes be used with hazardous materials, operations, and equipment. It is beyond the scope of this manual to address all of the potential safety problems associated with its use in such applications. It is the responsibility of the user of this pipette to consult and establish appropriate safety and health practices and determine the applicability of regulatory limitations prior to use.



### Please read the following carefully!

1. Every user must read and understand this operating manual prior to using the instrument and observe these instructions during use.
2. Follow general instructions for hazard prevention and safety instructions; e.g., wear protective clothing, eye protection and gloves. When working with infectious or other hazardous samples, all appropriate regulations and precautions must be followed.
3. Observe all specifications provided by reagent manufacturers.
4. Never use the instrument in an atmosphere with a danger of explosion. Highly flammable liquids must not be pipetted.
5. Only use the instrument for pipetting liquids that conform to the specifications defined in the operating exclusions and limitations (see page 43). If in doubt, contact the manufacturer or supplier.
6. Always use the instrument in such a way that neither the user nor any other person is endangered. Avoid splashes and only use suitable vessel.
7. Avoid touching the tip orifices when working with hazardous samples.
8. Never use force on the instrument!
9. Only use original spare parts. Do not attempt to make any technical alterations. Do not dismantle the instrument any further than is described in the operating manual!
10. Before use check the instrument for visible damages. If there is a sign of a potential malfunction (e.g., piston difficult to move, leakage), immediately stop pipetting. Consult the 'Troubleshooting' section of this manual (see page 72), and contact the manufacturer if needed.
11. The original battery must not be replaced with non rechargeable batteries or rechargeable batteries of other manufacturers.
12. To charge the NiMH battery pack, use only the original AC adapter.
13. The AC adapter has to be protected against moisture and must be used only for this instrument.
14. Dispose of batteries only when discharged and according to applicable regulations.

### Warning!

Improper use of the instrument or the batteries (short circuit, mechanical damage, overheating, incorrect AC adapter, etc.) can lead to battery explosion.

The Transferpette®-8/-12 electronic is a microprocessor-controlled, battery-operated piston-stroke multichannel pipette which uses the air-displacement principle for the pipetting of aqueous solutions with an average density and viscosity.

When the instrument is used properly, the sample only comes into contact with the tips and not with the Transferpette®-8/-12 electronic.

### Limitations of use

The Transferpette® electronic is intended for the pipetting of liquids within the following limitations:

- Temperature of both the instrument and solution should be between 15 °C to 40 °C (59 °F to 104 °F). Consult the manufacturer for use in temperatures outside of this range.
- Vapor pressure up to 500 mbar
- Viscosity: 260 mPa s (260 cps)

### Operating Limitations

Viscous and highly adhesive liquids may impair volumetric accuracy. Volumetric accuracy may also be impaired when pipetting liquids that differ from ambient temperature by more than  $\pm 5$  °C / 41 °F.

### Operating exclusions

The user has to ensure the compatibility of the instrument with the intended application.

Never use the instrument for pipetting liquids, that react adversely with polypropylene, polyvinylidene fluoride and silicone (PP: shaft and tips), polycarbonate/polybutyleneterephthalate (PC/PBT: casing) or EPDM (flexible replacement pipette shafts). Avoid reactive vapors due to the danger of corrosion.

The handle is not autoclavable.

### Battery and AC adapter specifications

#### Battery

Nickel-metal hydride battery with 3 cylindrical individual cells with size AAA, 3.6 V, 700 mAh

#### AC adapter

Output voltage 6.5 V DC, 200 mA

# Operating Elements

The Transferpette®-8/-12 electronic is a microprocessor-controlled, battery-operated, piston-stroke multichannel pipette, which has been optimized for ergonomic operation and ease of use.

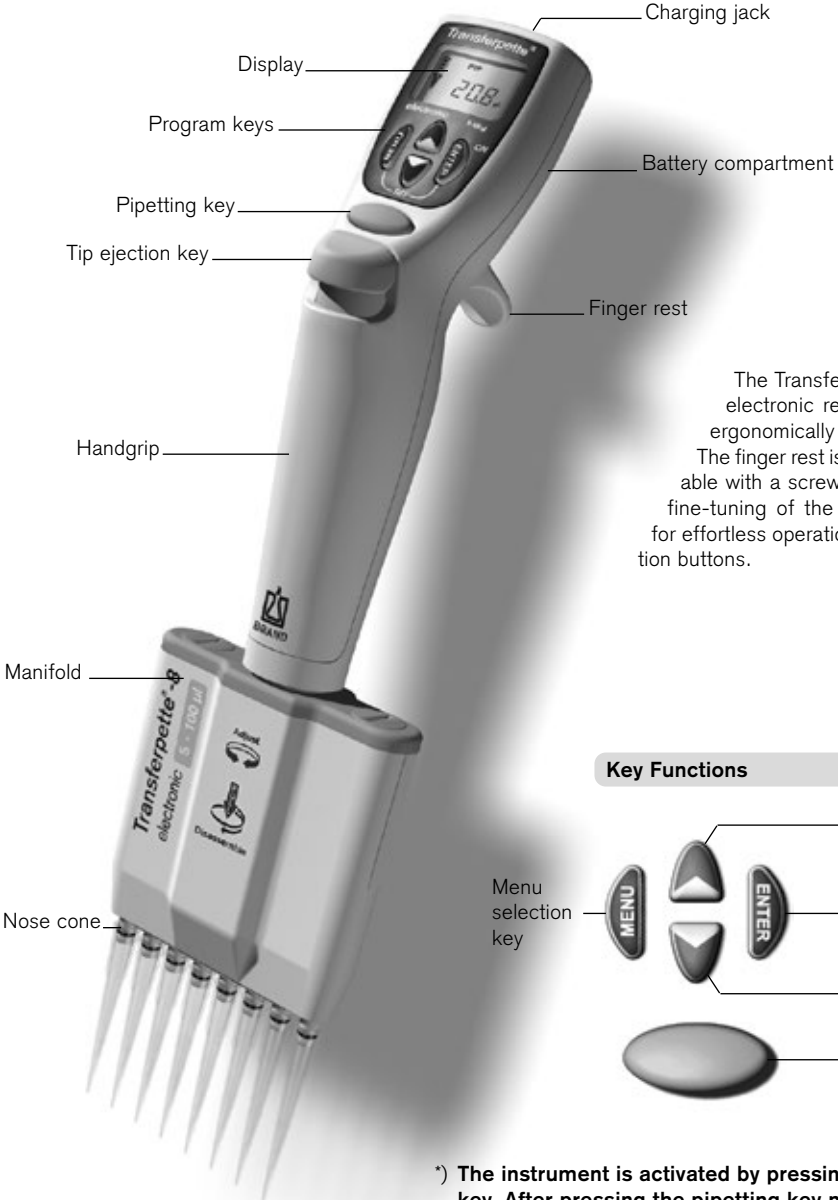

The Transferpette®-8/-12 electronic rests easily and ergonomically in your hand. The finger rest is height adjustable with a screw, which allows fine-tuning of the hand position for effortless operation of the function buttons.

## Key Functions

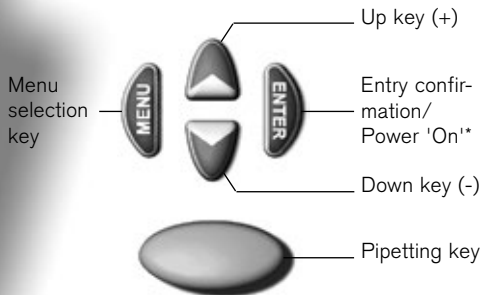

**\*) The instrument is activated by pressing the ENTER key. After pressing the pipetting key next, the instrument is ready for pipetting.**

The Transferpette®-8/-12 electronic shuts off 10 min after the last instrument operation (Auto-Power-Off).

**Is everything in the package?**

Confirm that your package includes: Transferpette®-8 or -12 electronic pipette, battery, power supply unit with battery charging cable, 1 instrument stand, 1 reagent reservoir, silicone grease, operating manual and 1 set of O-rings made of silicone.

**Initializing the Transferpette®-8/-12 electronic**

**1. Insert the battery**

- a) Open the cover of the battery compartment.
- b) Insure that the plug for the battery is firmly connected to the pipette. Insert the battery.
- c) Replace the battery compartment.



**2. Activate the instrument**

The Transferpette®-8/-12 electronic automatically requests a reference run directly after the battery is inserted. After the pipetting key is pressed, the reference run is carried out and the instrument is now ready for pipetting.

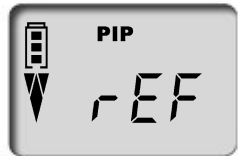



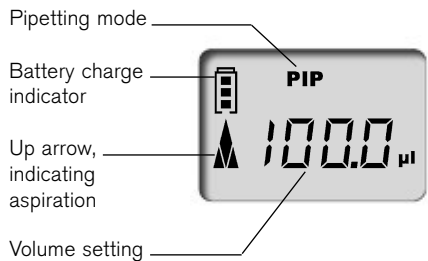





The display shows the standard factory setting (pipetting mode/PIP); and the nominal volume (for example, 100.0 µl). Default aspiration and discharging speeds are at maximum. The adjustment of volume and speed is described on the following pages.



# Setting the Volume

The volume for the Transferpette®-8/-12 electronic is set at the factory to the nominal volume of the instrument and can be changed quickly and easily.

What to do	How to do it	Keys to press	Display readout
<b>1. Activate volume setting</b>	Press one of the arrow keys to activate volume selection. ,VOL' blinks.		
<b>2. Change the volume</b>			
<b>Reduce volume</b>	Press the down arrow key (-) to reduce the volume. Holding the arrow key down accelerates the rate of change. ,VOL' continues to blink.		
<b>Increase volume</b>	Press the up arrow key (+) to increase the volume. Holding the arrow key down accelerates the rate of change. ,VOL' continues to blink.		
<b>3. Confirm volume setting</b>	Press the ENTER key. The display now shows the new volume setting, in this case, 102.8 µl in the PIP mode.	 1x	

### Important:

By pressing the MENU key any procedure can be cancelled! The display then moves to the next setting or back to the initial display (depending on actual selection.)







# Setting the Aspiration and Discharging Speed



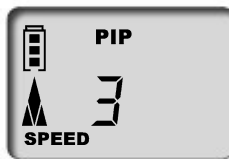

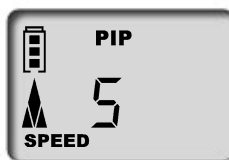
The aspiration and discharging speeds can be individually adjusted. When the menu is called up, the last speed setting is shown. Five speed levels are available.

What to do	How to do it	Keys to press	Display readout
------------	--------------	---------------	-----------------

## Setting the aspiration speed

<b>1. Bring up the menu</b>	Press the MENU key once to bring up the aspiration speed menu. <b>'Speed'</b> blinks.		
<b>2. Change the aspiration speed</b>	Press one of the arrow keys (+/-) to select the desired speed (in this case, level 5). <b>'Speed'</b> continues to blink.		
<b>3. Confirm speed level</b>	Press the ENTER key. The display returns to the start position for the current pipetting mode (in this case, the standard PIP mode).		

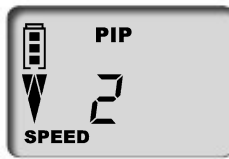
## Setting the discharging speed

<b>1. Bring up the menu</b>	Press the MENU key twice to bring up the discharging speed menu. <b>'Speed'</b> blinks.		
<b>2. Change the discharging speed</b>	Press one of the arrow keys (+/-) to select the desired speed (in this case, level 2). <b>'Speed'</b> continues to blink.		
<b>3. Confirm speed level</b>	Press the ENTER key. The display returns to the start position for the current pipetting mode (in this case, the standard PIP mode).		

The volume is set at the factory to the nominal volume for the Transferpette®-8/-12 electronic and can be changed quickly and easily. See page 46.

## Quick start in the standard pipetting mode

### 1. Attach the tips

Use the correct tips according to the volume range or the color code. Ensure that the tips are securely seated. Pipette tips are disposable items!

### 2. Align the manifold

The manifold can turn freely in both directions.

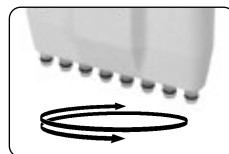

### 3. Aspirate liquid

Hold the pipette vertically and immerse the tips 2 to 3 mm into the liquid.



Press the pipetting key to aspirate the liquid into the tips. The arrow in the display points upwards to indicate the aspiration of liquid.



**Note:** To avoid the intake of air, leave the tips immersed into the liquid for approx. 1 sec.

### 4. Discharge liquid

After the liquid has been aspirated, the arrow in the display points downwards to indicate discharging.

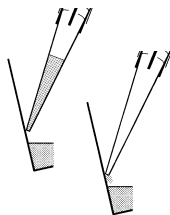

Hold the pipette at an angle between 30° and 45°, place the tips against the vessel wall.

Press the pipetting key again and the liquid is completely discharged including automatic blowout. Afterwards wipe pipette tips against the vessel wall.



### 5. Eject tips

Hold the manifold over a suitable disposal container and press the tip ejection key.

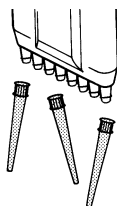









**Note:**

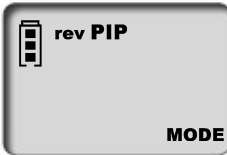

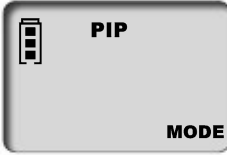

ISO 8655 prescribes rinsing the pipette tips once with the sample liquid prior to the actual pipetting process.

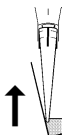

	Page
<b>1. Normal Pipetting</b>	
<b>PIP</b> Mode _____	<b>50</b>
<p>Standard program. A previously set volume is aspirated into the pipette tip and then discharged.</p>	
<b>2. Mixing of Samples</b>	
<b>PIPMix</b> Mode _____	<b>52</b>
<p>Program for mixing liquids. The sample is repeatedly aspirated and discharged.</p>	
<b>3. Reverse Pipetting</b>	
<b>revPIP</b> Mode _____	<b>54</b>
<p>Program especially for pipetting liquids with a high viscosity or vapor pressure, or that tend to foam.</p>	
<b>4. Pipetting for Electrophoresis</b>	
<b>GEL</b> Mode _____	<b>56</b>
<p>Program for loading electrophoresis gels. A predefined sample volume is aspirated at high, adjustable speed and then slowly discharged.</p>	
<b>5. Dispensing</b>	
<b>DISP</b> Mode _____	<b>58</b>
<p>Program for dispensing liquids. An aspirated volume is dispensed repeatedly in defined steps.</p>	

The standard program – a previously set volume is aspirated and then discharged.  
Volume and speed adjustments are described on pages 46 and 47.

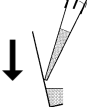
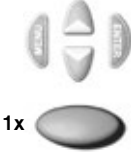
What to do	How to do it	Keys to press	Display readout
1. Bring up the menu	Press the MENU key three times to bring up the mode selection menu. <b>Mode</b> blinks.	3x 	
2. Select PIP mode	Use one of the arrow keys to scroll through the modes until <b>PIP</b> appears. <b>Mode</b> continues to blink.		
3. Confirm PIP mode	Press the ENTER key. The display now shows <b>blo</b> for blow-out.	 1x	
4. Prepare for pipetting	Press the pipetting key once to move the pistons into the start position. The arrow in the display points upwards (aspiration).	 1x	
5. Aspirate liquid	Press the pipetting key once to aspirate the liquid.	 1x	







What to do	How to do it	Keys to press	Display readout
<p><b>6. Discharge liquid</b></p> 	<p>Press the pipetting key once to discharge the liquid. The arrow in the display points downwards (discharge).</p>		

<p><b>7. Start blow-out?</b></p>	<p><b>No action required!</b> When pipetting in the PIP mode the <b>blow-out function is performed automatically.</b></p>		
----------------------------------	---	---	--

## Start blow-out manually

The blow-out function can, if necessary, be initiated manually at any time.

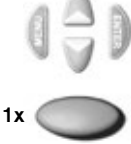





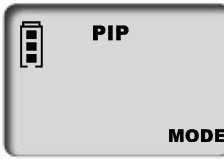

<p><b>1. Bring up the blow-out function</b></p>	<p>Press the ENTER key. The display shows <b>‚blo‘</b> for blow-out.</p>		
---	--	--	---

<p><b>2. Start blow-out</b></p>	<p>Press the pipetting key once to initiate the blow-out process. The display moves back to the start position of the selected pipetting mode.</p>		
---------------------------------	--	---	--

**Note:**

To accomplish the blow-out, the pistons move to the lowest position. The user must be certain that any residual liquid is discharged safely. **If the pipetting key is pressed and held, the pistons will be maintained at their lowest position to avert an accidental aspiration of liquid. When the key is released, the pistons return to the start position**

Program for mixing of liquids. The sample is repeatedly aspirated and discharged.  
Volume and speed adjustments are described on pages 46 and 47.

What to do	How to do it	Keys to press	Display readout
1. Bring up the menu	Press the MENU key three times to bring up the mode selection menu. <b>,Mode'</b> blinks.	3x 	
2. Select PIPmix mode	Scroll through the modes using the arrow keys until <b>,PIPmix'</b> appears. <b>,Mode'</b> continues to blink.		
3. Confirm PIPmix mode	Press the ENTER key. The Display now shows <b>,blo'</b> for blow-out.	 1x	
4. Prepare for pipetting	Press the pipetting key once to move the pistons into the start position. The arrow in the display points upwards (aspiration).	 1x	
5. Aspirate liquid	Press the pipetting key once to aspirate the liquid.	 1x	

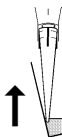

What to do	How to do it	Keys to press	Display readout
------------	--------------	---------------	-----------------

**6. Discharge liquid in the PIPmix mode**

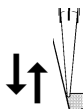

Press and hold the pipetting key and the liquid is alternately aspirated and discharged. The display shows the up arrow for aspiration and the down arrow for discharging and the number of cycles.



press and hold



**7. End pipetting**

Press the pipetting key once and the liquid is discharged and the blow-out function initiated.

After the discharge of the residual liquid (blow-out), the display moves back to the start position.















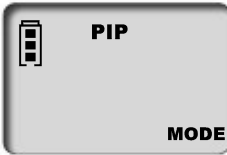





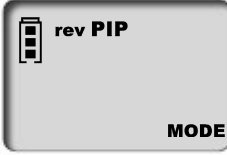















1x







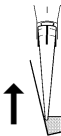
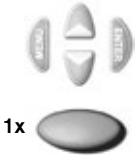

**Note:** The display shows a maximum of 19 cycles.

Program for pipetting of liquids with high viscosity, vapor pressure or that tend to foam.  
Volume and speed adjustments are described on pages 46 and 47.



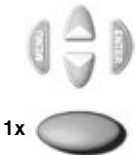
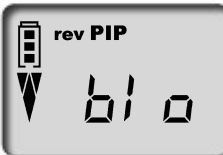





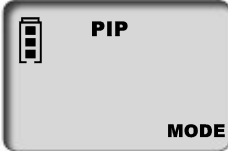

What to do	How to do it	Keys to press	Display readout
1. Bring up the menu	Press the MENU key three times to bring up the mode selection menu. <b>,Mode'</b> blinks.	3x     	
2. Select revPIP mode	Scroll through the modes using the arrow keys until <b>,revPIP'</b> appears. <b>,Mode'</b> continues to blink.	    	
3. Confirm revPIP mode	Press the ENTER key. The Display now shows <b>,blo'</b> for blow-out.	    1x 	
4. Prepare for pipetting	Press the pipetting key once to move the pistons into the start position. The arrow in the display points upwards (aspiration).	     1x	
5. Aspirate liquid	Press the pipetting key once. The volume aspirated will be a little bit more than set.	     1x	
6. Discharge liquid in the revPIP mode	To discharge the measured amount of liquid, press the pipetting key once. The arrow in the display points downwards (discharge). Some liquid will remain in the tips.	     1x	







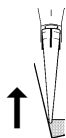

What to do	How to do it	Keys to press	Display readout
<p><b>7. Repeat aspiration of liquid in revPIP mode</b></p> 	<p>Press the pipetting key again and the set volume is aspirated into the tips. Press the pipetting key again and the volume is discharged again, and so on...</p>		
<p><b>8. Initiate blow-out</b></p>	<p>Press the ENTER key after the last pipetting operation. The display shows <b>,blo'</b> for blow-out.</p>		
	<p>Press the pipetting key once to initiate the blow-out process. The residual liquid is discharged.</p>		
<p><b>9. End pipetting</b></p>	<p>After the residual liquid is discharged (blow-out), the display moves back to the start position.</p>		

# Electrophoresis (GEL) Mode

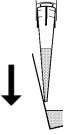
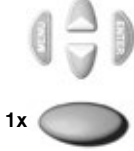
Program for loading electrophoresis gels. A predefined sample volume is aspirated into the pipette tips with high adjustable speed and then slowly discharged. Volume and speed adjustment is described on pages 46 and 47.

What to do	How to do it	Keys to press	Display readout
1. Bring up the menu	Press the MENU key three times to bring up the mode selection menu. <b>,Mode'</b> blinks.	3x 	
2. Select GEL mode	Scroll through the modes using the arrow keys until <b>,GEL'</b> appears. <b>,Mode'</b> continues to blink.		
3. Confirm GEL mode	Press the ENTER key. The Display now shows <b>,blo'</b> for blow-out.	 1x	
4. Prepare for pipetting	Press the pipetting key once to move the pistons into the start position. The arrow in the display points upwards (aspiration).	 1x	
5. Aspirate liquid	Press the pipetting key once. The set volume is aspirated into the tips.	 1x	
	<b>Aspirate a larger volume</b> In order to aspirate a larger volume than was set (up to a max. of 110% of the nominal volume), press and hold the pipetting key until the desired volume has been aspirated. The display shows a rhombus.	 press and hold	

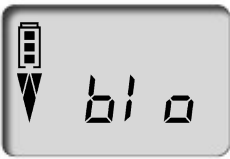
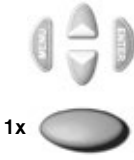
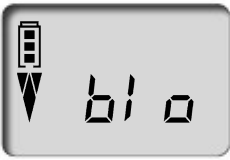









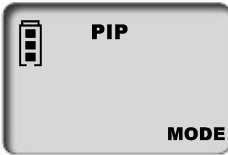

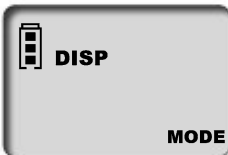

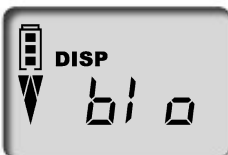

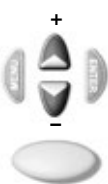





What to do	How to do it	Keys to press	Display readout
<b>6. Discharge liquid in the GEL mode</b>  	Press the pipetting key once to discharge the liquid. The rhombus is shown in the display. The liquid is discharged very slowly.		
	<b>Interrupt discharging</b> To interrupt discharging, press the pipetting key again. The display shows the volume discharged prior to interruption.		
<b>7. Initiate blow-out</b>	Press the ENTER key after the last pipetting operation. The display shows <b>,blo'</b> for blow-out.		
	Press the pipetting key once to initiate the blow-out process. The residual liquid is discharged.		
<b>8. End pipetting</b>	After the residual liquid is discharged (blow-out), the display moves back to the start position.		

**Note:**

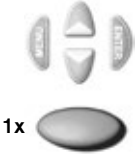
The GEL mode operates using a very slow discharge speed to prevent swirling of the samples. To assure optimal discharging into a gel, this discharge speed is fixed for the GEL mode. This speed is significantly slower than level 1 and cannot be selected individually.

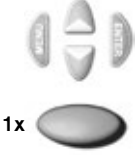
Program for discharging an aspirated liquid in pre-defined steps.  
 The volume aspirated will be a little bit more than actually needed.  
 Speed adjustment is described on page 47.

What to do	How to do it	Keys to press	Display readout
1. Bring up the menu	Press the MENU key three times to bring up the mode selection menu. ,Mode' blinks.	3x 	
2. Select DISP mode	Scroll through the modes using the arrow keys until ,DISP' appears. ,Mode' continues to blink.		
3. Confirm DISP mode	Press the ENTER key. The Display now shows ,blo' for blow-out.	 1x	
4. Prepare for dispensing	Press the pipetting key once to move the pistons into the start position. The arrow in the display points upwards (aspiration).	 1x	
5. Set dispensing step volume	Press the arrow keys (+/-) to set the volume. Holding the arrow key down accelerates the rate of change. ,VOL' blinks.		
6. Confirm dispensing step volume	Press the ENTER key. The display now shows the new volume setting for the dispensing steps and the max. number of steps. ,Steps' blinks.	 1x	

What to do	How to do it	Keys to press	Display readout
7. Set the number of steps	Press the arrow keys (+/-) to set the number of steps. <b>'Steps'</b> continues to blink.		
8. Confirm the number of steps	Press the ENTER key. The display now shows the number of steps that has been set.		
9. Aspirate liquid	Press the pipetting key once to aspirate the liquid.		
10. Dispense liquid	Each time the pipetting key is pressed one dispensing step is performed. The arrow in the display points downwards (discharge). The display shows the number of dispensing steps left.		
11. Initiate blow-out	Press the ENTER key after the last dispensing step. The display shows <b>'blo'</b> for blow-out. Press the pipetting key next once to initiate the blow-out process (see also p. 57).		
12. End dispensing	After the residual liquid is discharged (blow-out), the display moves back to the start position.		

# Checking the Volume

Depending on use, we recommend inspection of the instrument every 3 to 12 months. The cycle can, however, be adjusted to individual requirements.

The gravimetric testing of the pipette volume is performed according to the following steps and is in accordance with DIN EN ISO 8655, Part 6.

## 1. Set nominal volume

Set volume to the maximum volume indicated on the instrument. See page 46 for procedure.

## 2. Condition the pipette

Condition the pipette before testing by using a pipette tips to aspirate and discharge the test liquid (distilled H<sub>2</sub>O) five times. After this, discard the pipette tips.

## 3. Carry out the test

- Attach new pipette tips and pre-rinse one time with test liquid.
- Aspirate liquid and pipette it into the weighing vessel.

**Note:** Each individual channel must be tested separately.

- Weigh the pipetted quantity with an analytical balance. Please follow the operating manual instructions from the balance manufacturer.
- Calculate the volume, taking the temperature into account.
- 3-10 pipettings and weighings per channel in three volume ranges (100 %, 50 %, 10 %) are recommended for statistical analysis.

### Calculation (for nominal volume)

$x_i$  = Weighing results  
 $n$  = Number of weighings

$Z$  = Correction factor  
(for example 1.0029 µl/mg at 20 °C, 1013 hPa)

Mean value  $\bar{x} = \frac{\sum x_i}{n}$

Mean volume  $\bar{V} = \bar{x} \cdot Z$

#### Accuracy\*

$$A\% = \frac{\bar{V} - V_0}{V_0} \cdot 100$$

$V_0$  = Nominal volume

#### Standard Deviation

$$s = Z \cdot \sqrt{\frac{\sum (x_i - \bar{x})^2}{n - 1}}$$

#### Coefficient of Variation\*

$$CV\% = \frac{100 s}{\bar{V}}$$

\*) = Calculation of accuracy (A %) and variation coefficient (CV %):

A % and CV % are calculated according to the formulas for statistical control.

## Accuracy Table

Final test values related to the nominal capacity (maximum volume) and the indicated volume steps indicated on the instrument, obtained when instrument and distilled water are equilibrated at ambient temperature (20 °C/68 °F) and with smooth operation. According to DIN EN ISO 8655.

CE



20 °C  
Ex

### Accuracy tolerances for the Transferpette®-8/-12 electronic

Volume range µl	Volume step µl	A* ≤ ± %	CV* ≤ %	Increment µl	Recommended type of tip, µl
0.5 - 10	10	1.2	0.8	0.01	0.5 - 20
	5	2.0	1.5		
	1	8.0	4.0		
1 - 20	20	1.0	0.5	0.02	0.5 - 20
	10	2.0	1.0		
	2	8.0	3.0		
5 - 100	100	0.8	0.25	0.1	2 - 200
	50	1.6	0.4		
	10	4.0	1.5		
10 - 200	200	0.8	0.25	0.2	2 - 200
	100	1.4	0.4		
	20	4.0	1.3		
15 - 300	300	0.6	0.25	0.5	5 - 300
	150	1.2	0.4		
	30	3.0	1.2		

\* A = Accuracy, CV = Coefficient of Variation

#### Note:







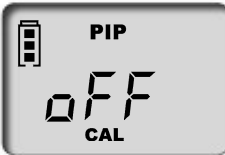

Testing instructions (SOPs) and a demo version of the EASYCAL™ 4.0 calibration software are available for download at [www.brand.de](http://www.brand.de).

## The calibration mode ,CAL'

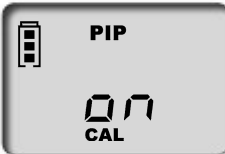
### Adjustment

The instrument should be set to either the nominal volume (for example 100 µl for a 100 µl pipette) or a specific test volume, in the standard pipetting mode (PIP). See page 46 and 50 for procedures. E.g., volume according to testing of volume 101,3 µl.

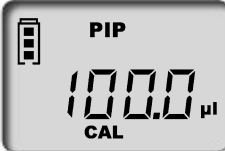

What to do	How to do it	Keys to press	Display readout
1. Bring up the CAL mode	Press and hold the MENU key (> 3 sec) until CAL appears. The display reads ,off'. ,CAL' blinks.	1x >3s 	
2. Activate the CAL mode	Press one of the arrow buttons to activate the CAL mode. The display changes from ,off' to ,on'. ,CAL' continues to blink.		
3. Confirm CAL mode	Press the ENTER key. The display now shows the set pipetting volume. ,CAL' blinks.		
4. Set the volume	Use the arrow keys (+/-) to set the volume, which was previously determined and tested. ,CAL' blinks.		
5. Confirm volume	Press the ENTER key. The display shows the tested and corrected volume. The CAL symbol is continuously displayed to confirm that an adjustment has been made.		



## Revert to factory default settings

The continually displayed CAL symbol refers to a previously made adjustment.



What to do	How to do it	Keys to press	Display readout
1. Bring up the CAL mode	Press and hold the MENU key (> 3 sec) until CAL appears. The display reads ,on'. ,CAL' blinks.	1x >3s	The display shows 'PIP' at the top, '0n' in the center, and 'CAL' at the bottom.
2. Deactivate CAL mode	Press one of the arrow keys to deactivate the CAL mode. The display changes from ,on' to ,off'. ,CAL' continues to blink.		The display shows 'PIP' at the top, '0ff' in the center, and 'CAL' at the bottom.
3. Revert to factory setting	Press the ENTER key. The CAL symbol disappears. The instrument has now been reverted to factory default setting.	1x	The display shows a battery level indicator on the left, 'PIP' at the top, '1000 µl' in the center, and 'CAL' at the bottom.

**Important:** When the Transferpette®-8/-12 electronic is adjusted, a volume offset is performed, which means that the volume is changed across the entire volume range of the pipette by the same amount. It is recommend that the adjustment be performed at 50% of the nominal volume.

**Note:** The instrument is permanently adjusted for watery solutions, but it can also be set for solutions with varying density, viscosity and temperature. The Transferpette®-8/-12 electronic can be adjusted in every mode, with the exception of the GEL mode.

## Autoclaving

The manifold (M) of the Transferpette®-8/-12 electronic (highlighted in picture) is autoclavable at 121 °C (250 °F), 2 bar absolute (30 psi) with a holding time of at least 15 minutes, according to DIN EN 285.

**Attention:** The handgrip can not be autoclaved!

1. Eject the pipette tips.
2. Unscrew the manifold from the grip (see page 66).
3. Autoclave the complete manifold without any further disassembling.
4. Allow the manifold to completely cool and dry.
5. Screw the manifold into the grip again (see page 66).
6. Perform a reference run (rEF).

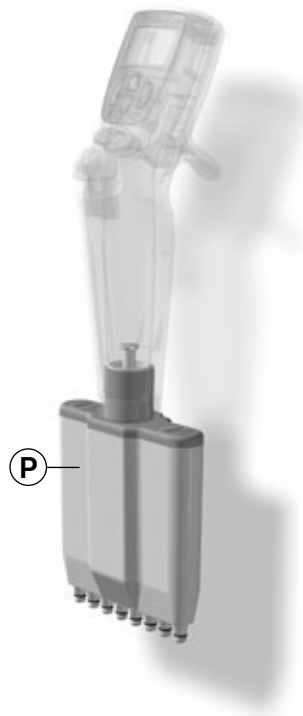

**Note:** The effectiveness of the autoclaving must be verified by the user.  
Maximum reliability is obtained with vacuum sterilization. We recommend the use of sterilization bags.

If the manifold is autoclaved frequently, then the pistons should be oiled with the supplied silicone grease in order to provide smoother movement.



## Reference run (rEF)

A manual reference run must be completed each time the manifold is reattached to the handle. The reference run is needed to assure secure connection of the piston.

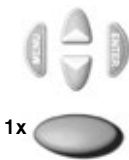
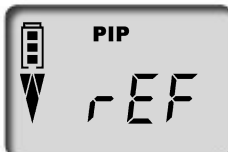
What to do	How to do it	Keys to press	Display readout
1. Bring up rEF mode	Simultaneously press the MENU and the ENTER key to activate the rEF mode.		
2. Perform the reference run	Press the pipetting key once to start the reference run. A noise can be heard, clearly indicating the function is being performed.		

**Note:** After the reference run, the display automatically returns to the previous program.

The three main components of the manifold can be easily separated and disassembled for servicing, cleaning or replacing parts. The procedures are illustrated on the following pages.

**Note:** The changing of the V-rings/O-rings on the individual nose cones is described in detail in the instructions enclosed with the spare part.

## The main components of the manifold

- A Piston unit** with piston support bar [I] and pistons inserted in this unit, which can be unscrewed individually for cleaning or replacement.
- B Nose cone assembly** with nose cone support bar [II] and central guide rod (Z), which is attached to this, and the nose cones and seals, which can be unscrewed individually for cleaning or replacement.
- C Manifold housing**, which is connected to the manifold housing cover [III] of the piston unit with two turn-lock fasteners.

## Servicing

In order to assure proper functioning, the Transferpette® -8/-12 electronic should be serviced and cleaned at regular intervals.

### What is to be inspected?

1. Inspect nose cones, pistons and seals for damage and contamination.
2. Test the sealing of the instrument. We recommend using the BRAND leak testing instrument PLT unit. Alternatively: to do this aspirate a sample, and then hold the instrument in a vertical position for about 10 sec. If a drop forms at the tip orifices, see the troubleshooting guide on page 72.

### Cleaning instructions (page 66-69)

1. Clean single nose cones, pistons and nose cone support bar/piston support bar (**these components only**) with soap solution or isopropyl alcohol. Afterwards rinse with distilled water.
2. Let these parts dry and cool down completely. Residual moisture in the nose cones may result in a loss of accuracy.
3. Grease the piston with a very thin coating of the silicone grease supplied. For the central guide rod (Z) only use the recommended fluorstatic grease!
4. After assembling the device, perform the reference run (rEF).

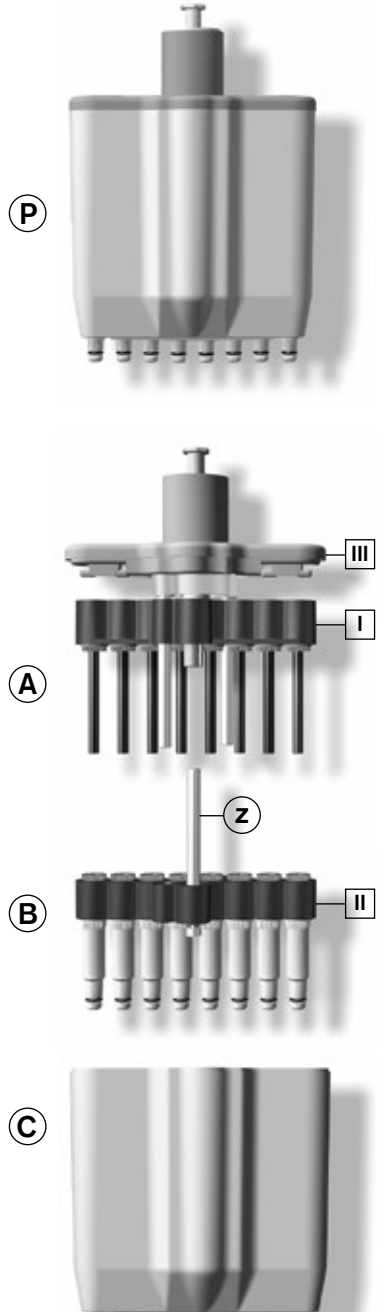

# Servicing and Cleaning

## Disconnecting handle from manifold

1. Eject the pipette tips.
2. To disconnect the manifold, pull it downward as far as possible, and **only then** turn it clockwise. After one rotation, it should no longer be pulled downward while it is being turned.
3. If the manifold is unscrewed pull it downward again to loosen the magnetic coupling.

### Note:

The manifold must be screwed into the handle counter-clockwise, until it audibly snaps into place. When mounting the manifold you must not pull it downward.

### Attention:

Improper handling can damage the unit!



## Removing of nose cones and seals for cleaning or replacing

1. **Unscrew manifold**      Unscrew the manifold from the handle.

2. **Slide off housing**      Turn both closures of the manifold housing cover 90° and slide off the housing.

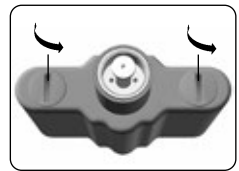

3. **Unscrew cone**      Push the mounting tool on the nose cone and unscrew it

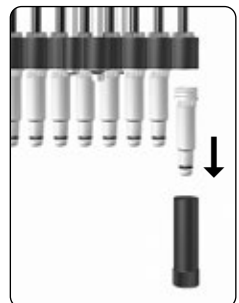

## 4. Remove seal

Push the piston unit down to the bottom. Remove the seal, inspect it and clean or replace if necessary

**Note:**

The seal will either remain inside the nose cone or will stay on the piston after the nose cone is removed.

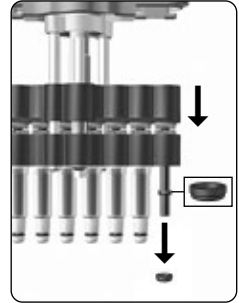

## 5. Mount seal

If required, grease the piston lightly with the supplied silicone grease. Push the seal on the piston with its flat side facing up-ward. Use the mounting tool to mount and tighten the cleaned or new nose cone.

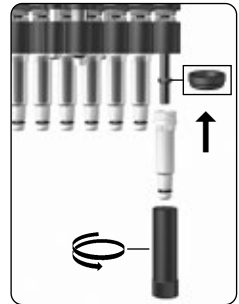

## 6. Reassemble manifold

Reassemble the manifold and mount it to the handle.

**Note:**

The manifold must be screwed into the handle counter-clockwise, until it audibly snaps into place.

You must not pull the manifold downward.

Check the instrument for tightness, mobility and accuracy (see page 65 "Servicing").

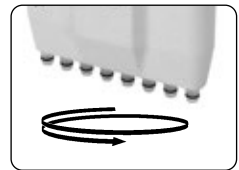

## 7. Perform reference run

Performe the reference run (rEF).

# Service and Cleaning

## Removing of pistons for cleaning or replacing

1. **Unscrew manifold**      Unscrew the manifold from the handle  
(See p. 66).

2. **Slide housing**      Turn both closures of the manifold housing cover  
90° and slide off the housing.

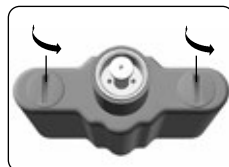

3. **Remove screws**      Remove both outer Phillips screws on the nose  
cone assembly.

**Attention:**

Do not loosen the central guide rod (Z)!

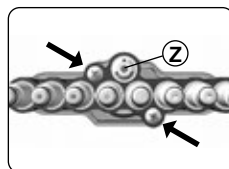

4. **Separate piston and nose cone assembly**      Pull the piston and nose cone assembly apart and  
separate.

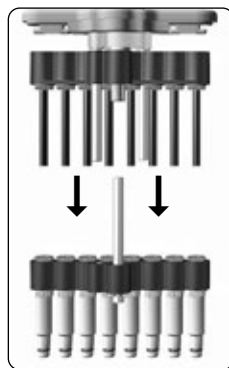

5. **Remove piston**      Place the mounting tool on the piston nut and un-  
screw the piston nut. Remove the piston nut and  
pull out the piston.

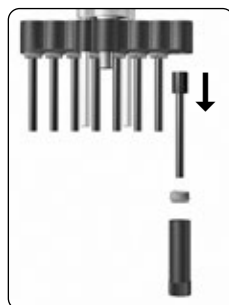

## 6. Mount piston

Insert the cleaned or new piston. Screw on the piston nut and tighten with the mounting tool

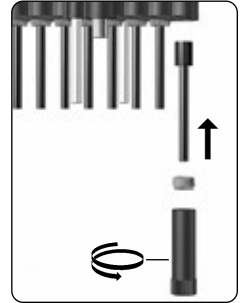

## 7. Reassemble piston and nose cone assembly

Loosen the nose cones by a half rotation. Afterward push the nose cone assembly on the piston unit and fasten it. Then tighten nose cones.

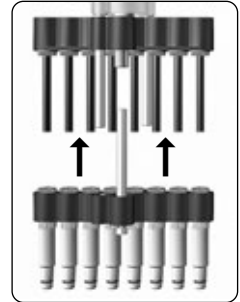

## 8. Mount manifold

Reassemble the manifold and mount it to the handle.

**Note:**

The manifold must be screwed counter-clockwise into the handle so that it audibly snaps into place. You must not pull the manifold downward.

Check the instrument for tightness, mobility and accuracy (see page 65 "Servicing").

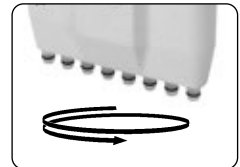

## 9. Perform reference run

Perform the reference run (rEF).

## Charging and Replacing the Battery

A fully charged battery allows approx. eight hours of continuous pipetting of liquids with a viscosity and density similar to water.

### Important!

Before charging the battery ensure that the AC adapter is compatible with the line voltage in the laboratory. Do not charge the device in an explosive environment. The battery can only be charged inside the Transferpette®-8/-12 electronic.

### Charge the battery

- Insert the charging cable plug for the AC adapter into the jack at the top of the Transferpette®-8/-12 electronic; charging starts automatically
- During the charging, the bars for the battery capacity run continually from the bottom to the top. The battery is fully charged, when the bars in the display have stopped moving.



### Pipetting during charging?

During charging, you can continue to work with the Transferpette®-8/-12 electronic. If the battery is fully discharged, it will take a few minutes until a certain minimum charge capacity is available, which is needed to operate the instrument safely.

**Note:** The last settings are stored in the memory of the instrument. If the battery is fully discharged or the battery is changed, these settings are saved.

### Replace the battery

- Open the battery compartment cover. Remove the battery and pull the plug gently out of the socket.
- Insert the plug of the new battery into the socket and insert the battery.
- Put the battery compartment cover in place again and close it.



Remove the battery from the instrument, when it is not to be used for longer periods.



## Charging and Replacing the Battery

### Battery display after inserting a battery

- a) After the battery is inserted, the display shows the **full capacity indicator with a blinking frame**, the instrument does not recognize the charging status right now. After 3.5 hours of charging time – safe full charging of the battery – the frame stops blinking.



**Note:** After inserting a battery always charge 3.5 hours!  
The full charge capacity is available after several charge/discharge cycles.

## Battery regeneration function

### (Refresh function)

In order to extend the service life and to optimize performance of the battery, the Transferpette®-8/-12 electronic has a regeneration function (refresh function). This program provides a controlled full discharge and recharging of the battery. To optimize the battery performance, this refresh function should be used periodically.

### Perform the refresh function

- a) Insert the plug for the AC adapter into the jack on the top of the Transferpette®-8/-12 electronic.



- b) Press and hold the lower arrow key (>3 sec). During the discharging process, the capacity bars for the battery indicator run continually from the top to the bottom.



- c) After the controlled discharge (up to 3 hours), the charging process (3.5 hours) is started automatically. During charging, the capacity bars run continually from the bottom to the top.













### Interrupting the refresh function

Press any button to end the program. The instrument switches automatically to the standard pipette mode (PIP) and to the nominal volume and the normal charging process is started automatically, see page 70. Removing the plug for the AC adapter also ends the program. Do not interrupt refresh function at the end of the discharge cycle.

## Troubleshooting

If an error occurs, the instrument display shows "Err" and the error number is also shown. The instrument will now only react to the ENTER key. Pressing the ENTER key will attempt to restart the instrument. Therefore, a reference run is automatically requested.

Problem	Error message	Possible cause	Corrective action
Instrument does not react		Battery discharged or faulty	Charge battery for at least 5 min without operating, then only operate with charging cable attached until battery is recharged. Replace battery if needed.
		Faulty electronic component	Send in the instrument for repair.
Instrument does not react		Faulty electronic component	Send in the instrument for repair.
Instrument does not react		Unpredicted program error	Confirm error by pressing the ENTER key. The instrument is reinitialized.
Instrument does not react		No battery inserted	Insert battery
		Battery is defective	Replace battery
		Faulty electronic component	Send in the instrument for repair.
Display is dark	—	Electrostatic discharge	Remove and insert the battery.
		Faulty electronic component	Send in the instrument for repair.
Tip drips/ instrument not sealed or volume error	—	Improper tip	Only use quality tips
		Tip is not properly seated	Press tip in firmly
		Piston, nose cone or seal is contaminated or damaged	Clean the instrument/ replace the seal. Grease piston.
Liquid is not aspirated or there is a loud motor noise	—	Piston movement is limited	Unscrew the manifold and move the metal part in the middle by hand.

Markings	Meaning
	With this mark, we confirm that the product complies with the requirements set out in the EC Directives and has been subjected to the specified testing procedures.
	The device is marked in accordance with the German Weights and Measures Act and the Weights and Measures Ordinance. Character sequence DE-M (DE for Germany), framed by a rectangle, as well as the two last digits of the year the marking was added (here: 2020).
XXZXXXXX	Serial number
	Follow the instructions listed on the device, the accessory parts and in the operating manual.
	The device or the battery should be disposed of properly.
	Observe the operating manual.
	China RoHS (EFUP) EFUP defines the time period in years, in which the hazardous materials found in the electrical and electronic equipment should not leak or mutate under normal operating conditions. When used under normal conditions, such electrical or electronic products do not lead to severe environmental pollution, severe personal injuries or damage to the user's property.
	This electrical device may not be disposed of in household waste.

### Transferpette®-8 electronic incl. AC adapter (100-240V/50-60 Hz)

Volume	0.5-10 µl	1-20 µl	5-100 µl	10-200 µl	15-300 µl
	Cat. No.	Cat. No.	Cat. No.	Cat. No.	Cat. No.
for Continental Europe	7053 99	7054 00	7054 03	7054 04	7054 06
for UK/Ireland	7054 09	7054 10	7054 13	7054 14	7054 16
for USA/Japan	7054 19	7054 20	7054 23	7054 24	7054 26
for Australia	7054 29	7054 30	7054 33	7054 34	7054 36

### Transferpette®-12 electronic incl. AC adapter (100-240V/50-60 Hz)

Volumen	0.5-10 µl	1-20 µl	5-100 µl	10-200 µl	15-300 µl
	Cat. No.	Cat. No.	Cat. No.	Cat. No.	Cat. No.
for Continental Europe	7054 49	7054 50	7054 53	7054 54	7054 56
for UK/Ireland	7054 59	7054 60	7054 63	7054 64	7054 66
for USA/Japan	7054 69	7054 70	7054 73	7054 74	7054 76
for Australia	7054 79	7054 80	7054 83	7054 84	7054 86

### AC adapters (100-240V/50-60 Hz)

Description	Cat. No.
for Continental Europe	7053 50
for UK/Ireland	7053 51
for USA/Japan	7053 52
for Australia	7053 53

**Spare parts Transferpette®-8/-12 electronic**

Parts will differ slightly depending on nominal volume of instrument. (Fig. shows spare parts for Transferpette® -8/-12 electronic 5-100 µl.)

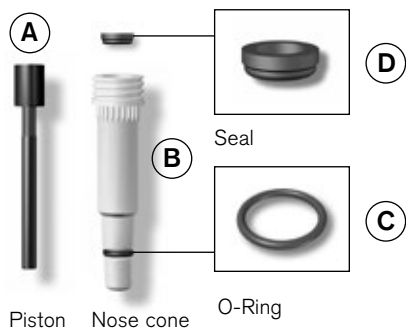

Volume	A	B*	C	D
0.5 - 10 µl	7056 59	7056 77	7033 80	7033 40
1 - 20 µl	7056 71	7056 78	7033 80	7033 41
5 - 100 µl	7056 62	7056 15	7056 18	7033 44
10 - 200 µl	7056 63	7056 16	7056 18	7033 45
15 - 300 µl	7056 64	7056 17	7056 18	7033 46

\* incl. seal, O-ring and mounting tool

**Quality pipette tips from BRAND,**  
racked in TipBox

Volume	Total tips per pack	Cat. No.
0.1 - 20 µl	480	7322 02
0.5 - 20 µl	480	7322 04
2 - 200 µl	480	7322 08
5 - 300 µl	480	7322 10

**Additional accessories**

Description	Cat. No.
Replacement battery	7055 00
Silicone grease	7036 77
Fluorstatic grease	7036 78
PLT unit	7039 70

## Return for repair

**Important!** Transporting of hazardous materials without a permit is a violation of federal law.

- Clean and decontaminate the instrument carefully.
- It is essential always to include an exact description of the type of malfunction and the media used. If information regarding media used is missing, the instrument cannot be repaired.
- Shipment is at the risk and the cost of the sender.

### Outside the U.S. and Canada:

- Complete the "Declaration on Absence of Health Hazards" and send the instrument to the manufacturer or supplier. Ask your supplier or manufacturer for the form. The form can also be downloaded from [www.brand.de](http://www.brand.de).

### In the U.S. and Canada:

- Contact BrandTech Scientific, Inc. and obtain authorization for the return **before** sending your instrument for service.
- Return only cleaned and decontaminated instruments, with the Return Authorization Number prominently displayed on the outside of the package to the address provided with the Return Authorization Number.

## Contact addresses

### BRAND GMBH + CO KG

Otto-Schott-Straße 25  
97877 Wertheim (Germany)  
Tel.: +49 9342 808-0  
Fax: +49 9342 808-98000  
E-Mail: [info@brand.de](mailto:info@brand.de)  
[www.brand.de](http://www.brand.de)

### USA and Canada:

BrandTech® Scientific, Inc.  
11 Bokum Road  
Essex, CT 06426-1506 (USA)  
Tel.: +1-860-767 2562  
Fax: +1-860-767 2563  
[www.brandtech.com](http://www.brandtech.com)

### India:

BRAND Scientific Equipment Pvt. Ltd.  
303, 3rd Floor, 'C' Wing, Delphi  
Hiranandani Business Park, Powai  
Mumbai - 400 076 (India)  
Tel.: +91 22 42957790  
Fax: +91 22 42957791  
E-Mail: [info@brand.co.in](mailto:info@brand.co.in)  
[www.brand.co.in](http://www.brand.co.in)

### China:

BRAND (Shanghai) Trading Co., Ltd.  
Guangqi Culture Plaza  
Room 506, Building B  
No. 2899, Xietu Road  
Shanghai 200030 (P.R. China)  
Tel.: +86 21 6422 2318  
Fax: +86 21 6422 2268  
E-Mail: [info@brand.cn.com](mailto:info@brand.cn.com)  
[www.brand.cn.com](http://www.brand.cn.com)

### Calibration Service

ISO 9001 and GLP-guidelines require regular examinations of your volumetric instruments. We recommend checking the volume every 3-12 months. The interval depends on the specific requirements on the instrument. For instruments frequently used or in use with aggressive media, the interval should be shorter. The detailed testing instruction can be downloaded on [www.brand.de](http://www.brand.de) or [www.brandtech.com](http://www.brandtech.com).

BRAND also offers you the possibility to have your instruments calibrated by the BRAND Calibration Service or the BRAND-owned DAkkS Calibration Service.

Just send in the instruments to be calibrated, accompanied by an indication of which kind of calibration you wish. Your instruments will be returned within a few days together with a test report (BRAND Calibration Service) or with a DAkkS Calibration Certificate. For further information, please contact your dealer or BRAND. Complete ordering information is available for download at [www.brand.de](http://www.brand.de) (see Technical Documentation).

## Warranty

We shall not be liable for the consequences of improper handling, use, servicing, operating or unauthorized repairs of the instrument or the consequences of normal wear and tear especially of wearing parts such as pistons, seals, valves and the breakage of glass as well as the failure to follow the instructions of the operating manual. We are not liable for damage resulting from any actions not described in the operating manual or if non-original spare parts or components have been used.

U.S. and Canada:  
Information for warranty please see [www.brandtech.com](http://www.brandtech.com).

## Disposal

---

The adjoining symbol means that storage batteries and electronic devices must be disposed of separately from household trash (mixed municipal waste) at the end of their service life.

- According to the Directive 2002/96/EC of the European Parliament and of the Council on Waste Electrical and Electronic Equipment (WEEE) of 27 January 2003, electronic equipment requires disposal according to the relevant national disposal regulations.



- Batteries contain substances that can have harmful effects on the environment and human health. Therefore according to the Directive 2006/66/EC of the European Parliament and the Council on Waste Batteries of 6 September 2006 batteries require disposal according to the relevant national disposal regulations. Dispose of batteries only when completely discharged.

**Warning!** Do not short-circuit the battery to discharge it!



	Page
Règles de sécurité	80
Fonction et limites d'emploi	81
Interdictions d'emploi	81
<b>Les éléments de commande</b>	<b>82</b>
Premiers pas	83
Réglage du volume	84
Réglage de la vitesse d'aspiration et d'éjection	85
Le pipetage correct	86
Les programmes de pipetage	87
Mode PIP	88
Mode PIPmix	90
Mode revPIP	92
Mode électrophorèse (GEL)	94
Mode DISP	96
Contrôle du volume	98
Table de précision	99
<b>Easy Calibration (ajustage)</b>	<b>100</b>
Autoclavage	102
Course d'essai (rEF)	102
Entretien et nettoyage	103
Recharge et remplacement de la pile	108
Fonction de régénération de la pile	109
Dérangement – que faire?	110
Marquage réglementaire sur le produit	111
Données de commande · Accessoires · Pièces de rechange	112
Réparation · Adresses de contact	114
Service de calibration · Garantie	115
Elimination	116

## Règles de sécurité

Cet appareil peut être utilisé avec des matériaux dangereux ou en relation avec des appareillages ou procédés dangereux. Le livret de mode d'emploi cependant n'a pas pour but d'exposer tous les problèmes de sécurité pouvant en résulter. Ce sera donc de la responsabilité de l'utilisateur d'être sûr que les consignes de sécurité et de santé seront respectées. C'est à lui de déterminer les restrictions correspondantes avant l'emploi de l'appareil.

### A lire attentivement

1. Chaque utilisateur doit avoir lu ce livret mode d'emploi avant l'emploi de l'appareil et en observer les instructions.
2. Tenir compte des avertissements de danger et suivre les règles de sécurité générales, comme par ex. en portant des vêtements de protection, protection des yeux et des mains.  
Lors de travaux avec des échantillons infectieux ou dangereux, les consignes ainsi que les mesures de précaution standards en vigueur dans les laboratoires doivent être observées.
3. Observer les données des fabricants de réactif.
4. Ne pas utiliser l'appareil dans une atmosphère pouvant provoquer des explosions. Des milieux facilement inflammables ne doivent pas être pipetés.
5. Employer uniquement l'appareil pour le pipetage de liquides en observant les limites d'emploi et les interdictions (voir page 81). En cas de doute, se renseigner auprès du fabricant et/ou du fournisseur.
6. Toujours travailler de façon à ne mettre en danger ni vous-même ni autrui. Eviter les éclaboussures et employer un collecteur approprié.
7. Eviter tout contact avec les orifices des pointes lors de travaux avec des fluides agressifs.
8. Ne jamais employer la force.
9. Employer uniquement les pièces de rechange originaux. Ne pas effectuer de modifications techniques. Ne pas démonter l'appareil plus que ce qui est indiqué dans le mode d'emploi
10. Avant l'utilisation vérifier l'état correct de l'instrument. Si des dérangements se manifestent (par ex. piston grippé, non-étanchéités), arrêter immédiatement le pipetage et consulter le chapitre 'Dérangement, que faire?' (voir page 110). Si besoin est, contacter le fabricant.
11. Ne pas remplacer l'accu original par des accus non rechargeables ou rechargeables d'autres fabricants.
12. Pour recharger les piles nickel-métal-hydrure, employer uniquement le bloc d'alimentation original.
13. Le bloc d'alimentation doit être protégé de l'humidité et ne doit être utilisé que pour cet appareil.
14. N'éliminer l'accu que quand il est déchargé complètement, et conformément au règlement en vigueur pour votre pays.

### Avertissement

Une manipulation incorrecte de l'appareil ou de la pile (court-circuit, destruction mécanique, surchauffe, bloc d'alimentation incorrect, etc.) peut, dans les situations extrêmes, occasionner l'explosion de la pile.

La Transferpette®-8/-12 electronic est une pipette à piston multicanaux conformément au principe du coussin d'air commandée par microprocesseur, elle fonctionne à l'aide de piles permettant de pipeter les solutions aqueuses de densité et de viscosité moyennes.

Dans la mesure où l'appareil est manipulé correctement, l'échantillon à doser entrera uniquement en contact avec les pointes et non pas avec la Transferpette®-8/-12 electronic.

### Limites d'emploi

Cet appareil a été conçu pour le pipetage d'échantillons sous réserve des limites suivantes:

- température de emploi de +15 °C à +40 °C (de 59 °F à 104 °F) de l'appareil et du réactif (d'autres plages température sur demande)
- pression de vapeur jusqu'à 500 mbar
- viscosité: 260 mPa s

### Interdictions d'emploi

C'est à l'utilisateur de vérifier si l'appareil est approprié pour l'emploi qu'il veut en faire.

Ne jamais employer l'appareil afin de pipeter les liquides attaquant les polypropylènes, fluorure de polyvinylidène et la silicone (tige et pointes), le polybutène-téréphtalate de polycarbonate (boîtier) ou EPDM (tiges de pipette de rechange flexibles). Éviter l'exposition aux vapeurs agressives (risque de corrosion)!

La partie poignée n'est pas autoclavable.

### Restrictions d'emploi

Les liquides visqueux ou mouillants peuvent influencer l'exactitude du volume. De même pour les liquides dont la température diffère de plus  $\pm 5$  °C / 41 °F de la température ambiante.

### Spécifications pile et bloc d'alimentation

#### Pile

Pile nickel-métal-hydrure avec 3 cellules cylindriques individuelles au format AAA, 3,6 V, 700 mAh

#### Bloc d'alimentation

Tension de sortie 6,5 V DC, 200 mA

## Les éléments de commande

La Transferpette®-8/-12 electronic est une pipette à piston multicanaux commandée par microprocesseur et fonctionnant sur pile, optimisée pour l'ergonomie de manipulation et la simplification du travail.

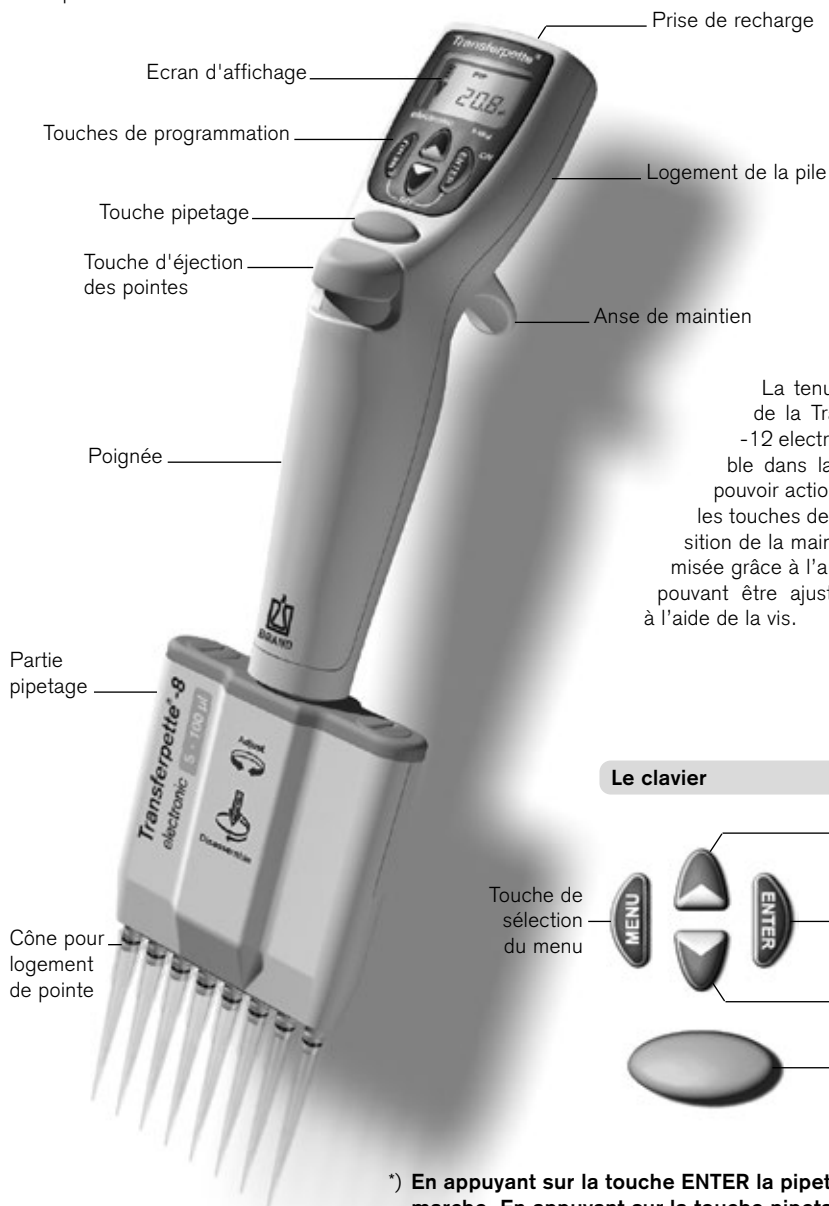

La tenue ergonomique de la Transferpette®-8/-12 electronic est agréable dans la main. Afin de pouvoir actionner sans peine les touches de fonction, la position de la main peut être optimisée grâce à l'anse de maintien pouvant être ajustée en hauteur à l'aide de la vis.

### Le clavier

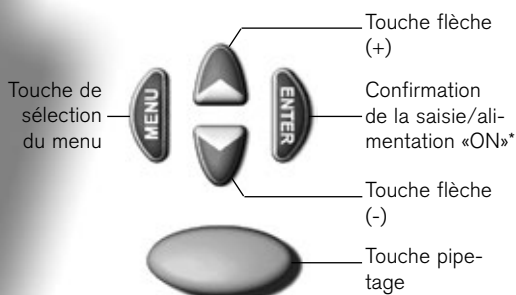

\*) En appuyant sur la touche ENTER la pipette est mise en marche. En appuyant sur la touche pipetage, la pipette est prête à l'emploi. 10 minutes après sa dernière utilisation, la Transferpette®-8/-12 electronic s'éteint automatiquement (arrêt automatique).

## Contenu de la livraison

L'emballage contient la Transferpette®-8 ou -12 electronic, une pile, le bloc d'alimentation avec câble de recharge de la pile, 1 support de pipette, 1 réservoir à réactif, graisse de silicone, le présent mode d'emploi ainsi que 1 jeu de anneau torique en silicone.

### Mise en service de la Transferpette®-8/-12 electronic

#### 1. Mise en place de la pile

a) Ouvrir le couvercle du logement de la pile.



b) Insérer une pile neuve. Veillez à ce que le connecteur de la pile soit bien enfoncé dans la prise de l'appareil.



c) Remettre le couvercle du logement de la pile en place puis le fermer.



#### 2. Activation de l'appareil

Directement après la mise en place de la pile, la Transferpette®-8/-12 electronic demande automatiquement une course de référence. Pour effectuer la course de référence, il suffit d'appuyer sur la touche de pipetage et l'appareil est prêt à l'emploi.

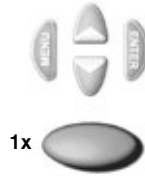

L'écran affiche le mode de pipetage par défaut programmé en usine (PIP) ainsi que le volume nominal (ici, 100,0 µl par ex.). Les vitesses d'aspiration et d'éjection sont réglées au maximum en usine. Le réglage simple du volume et de la vitesse est expliqué sur les pages suivantes.

Mode de pipetage

Indicateur du niveau de charge de la pile







Symbole «d'aspiration»

Indication du volume

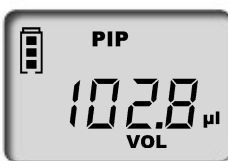

## Réglage du volume

Le volume nominal correspondant de la Transferpette®-8/-12 electronic a été ajusté en usine et se laisse facilement et rapidement modifier de manière individuelle.

Que dois-je faire?	Comment procéder?	Quelle touche?	Qu'affiche l'écran?
<b>1. Activation de la sélection du volume</b>	Il suffit d'appuyer sur l'une des touches flèches afin de pouvoir directement sélectionner un volume. «VOL» clignote.		
<b>2. Réglage du volume</b>			
<b>Diminution</b>	Pour diminuer le volume, il suffit d'appuyer sur la touche flèche (-). Une pression prolongée augmente la vitesse de défilement du volume. «VOL» clignote toujours.		
<b>Augmentation</b>	Pour augmenter le volume, il suffit d'appuyer sur la touche flèche (+). Une pression prolongée augmente la vitesse de défilement du volume. «VOL» clignote toujours.		
<b>3. Confirmation du volume sélectionné</b>	Appuyer sur la touche ENTER. L'écran affiche alors le nouveau volume programmé. Dans l'exemple ci-contre, l'écran affiche le mode PIP programmé par défaut.	 1x	

### Important:





Chaque procédure de réglage peut être interrompue en actionnant la touche MENU. L'affichage passe alors à l'opportunité de réglage suivante ou à l'écran de départ.

## Réglage de la vitesse d'aspiration et d'éjection



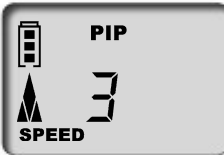

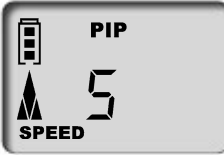
La vitesse d'aspiration et la vitesse d'éjection peuvent être réglées séparément. Lors de l'appel du menu, la dernière vitesse programmée s'affiche. 5 vitesses sont disponibles.

Que dois-je faire?	Comment procéder?	Quelle touche?	Qu'affiche l'écran?
--------------------	-------------------	----------------	---------------------

### Réglage de la vitesse d'aspiration

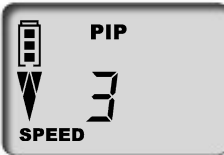
- |                                       |   |   |  |
|---------------------------------------|---|---|--|
| 1. Appel du menu                      | Pour accéder au menu de la vitesse d'aspiration, appuyer brièvement sur la touche MENU. «Speed» clignote.   | 1x<br> |  |
| 2. Réglage de la vitesse d'aspiration | La vitesse peut être sélectionnée à l'aide des touches flèches (+/-) (niveau 5, par ex.). «Speed» clignote toujours.  |        |  |
| 3. Confirmation du niveau de vitesse  | Appuyer sur la touche ENTER. L'affichage retourne à l'écran initial du mode programmé. Dans l'exemple ci-contre, il s'agit de l'affichage du mode PIP programmé par défaut, par ex. |  1x    |  |

### Réglage de la vitesse d'éjection

- |                                      |   |  |  |
|--------------------------------------|---|--|--|
| 1. Appel du menu                     | Pour accéder au menu de la vitesse d'éjection, appuyer brièvement sur la touche MENU. «Speed» clignote.   | 2x<br> |   |
| 2. Confirmation du niveau de vitesse | Appuyer sur la touche ENTER. L'affichage retourne à l'écran initial du mode programmé. Dans l'exemple ci-contre, il s'agit de l'affichage du mode PIP programmé par défaut p. ex.   |       |  |
| 3. Confirmation du niveau de vitesse | Appuyer sur la touche ENTER. L'affichage retourne à l'écran initial du mode programmé. Dans l'exemple ci-contre, il s'agit de l'affichage du mode PIP programmé par défaut, par ex. |  1x   |  |

Le volume nominal correspondant de la Transferpette®-8/-12 electronic a été ajusté en usine et se laisse facilement et rapidement modifier de manière individuelle (voir page 86).

## Démarrage rapide avec le mode de pipetage par défaut

### 1. Insertion des pointes

N'utiliser que des pointes appropriées correspondant au volume ou au code couleur! Veiller à l'étanchéité et à la mise en place correcte des pointes. Les pointes de pipette sont des articles à usage unique.

### 2. Aligner la partie pipetage

La partie pipetage peut être tournée librement dans le deux sens.

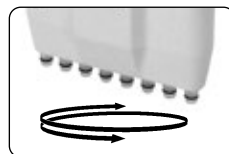

### 3. Aspiration de liquide



Tenir l'appareil à la verticale et immerger 2 à 3 mm des pointes dans le liquide.

Pour aspirer le liquide, il suffit d'actionner la touche pipetage. La flèche sur l'écran pointe vers le haut (aspiration).



**Remarque:** Afin de ne pas aspirer d'air, laisser encore les pointes immergées durant env. 1 s

### 4. Ejection du liquide

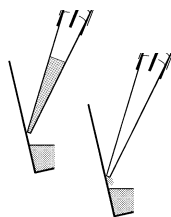

Après avoir aspiré un liquide, la flèche sur l'écran pointe vers le bas (éjection). Placer les pointes de pipette contre la paroi du récipient. La tenir inclinée en respectant un angle compris entre 30 et 45°.

En appuyant à nouveau sur la touche pipetage, le liquide est intégralement éjecté par le biais d'un dépassement de course automatique. Tirer les pointes de la pipette contre la paroi du récipient.



### 5. Mise au rebut des pointes

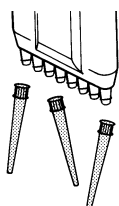

Tenir la partie pipetage au-dessus d'un collecteur de déchets approprié puis enfoncer la touche d'éjection des pointes.

Touche d'éjection des pointes









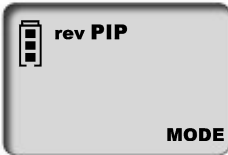

**Remarque:**

La norme ISO 8655 prescrit de rincer les pointes de pipette avec le liquide d'essai avant l'opération de pipetage elle-même.

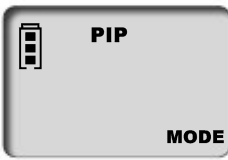

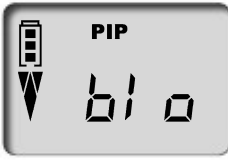

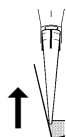

	Page
<b>1. Pipetage normal</b>	
Mode <b>PIP</b>	<b>88</b>
<p>Programme par défaut. Un volume programmé préalablement est aspiré puis éjecté.</p>	
<b>2. Dispersion de l'échantillon</b>	
Mode <b>PIPmix</b>	<b>90</b>
<p>Programme permettant de mélanger les liquides. L'échantillon est aspiré puis éjecté à plusieurs reprises.</p>	
<b>3. Pipetage inverse</b>	
Mode <b>revPIP</b>	<b>92</b>
<p>Programme conçu pour le pipetage de liquides à viscosité élevée, à tension de vapeur élevée ou les fluides moussants.</p>	
<b>4. Pipetage électrophorèse</b>	
Mode <b>GEL</b>	<b>94</b>
<p>Programme permettant de charger les gels électrophorèse. Un volume défini au préalable de l'échantillon est aspiré à vitesse constante et rapide avant d'être lentement éjecté.</p>	
<b>5. Distribution</b>	
Mode <b>DISP</b>	<b>96</b>
<p>Programme permettant la distribution d'un volume de liquide en plusieurs fractions.</p>	

Le programme par défaut, un volume programmé auparavant est aspiré puis éjecté. Le réglage du volume et de la vitesse sont décrits en pages 84 et 85.

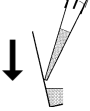
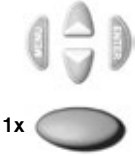
Que dois-je faire?	Comment procéder?	Quelle touche?	Qu'affiche l'écran?
1. Appel de la sélection du menu	Pour accéder à la sélection du programme, il suffit d'appuyer trois fois sur la touche MENU. «Mode» clignote.	3x 	
2. Réglage du mode PIP	Faire défiler les modes à l'aide des touches fleches jusqu'à ce que «PIP» s'affiche. «Mode» clignote toujours.		
3. Confirmation du mode PIP	Appuyer sur la touche ENTER. L'écran affiche maintenant «blo» pour «blow-out» (dépassement de course).	 1x	
4. Préparation du pipetage	En appuyant une fois sur la touche pipetage, les pistons sont avancés en écran initial. La flèche sur l'écran pointe vers le haut (aspiration).	 1x	
5. Aspiration du liquide	Pour aspirer le liquide, il suffit d'appuyer une fois sur la touche pipetage.	 1x	







Que dois-je faire?	Comment procéder?	Quelle touche?	Qu'affiche l'écran?
<p><b>6. Ejection du liquide</b></p> 	<p>Pour éjecter le liquide, il suffit d'appuyer une fois sur la touche pipetage. La flèche sur l'écran pointe vers le bas (éjection).</p>		

<p><b>7. Déclenchement du dépassement de course?</b></p>	<p><b>Vous ne devez absolument rien faire!</b> Le dépassement de la course (blow-out) est entièrement automatique lors du pipetage en mode PIP!</p>		
--	---	---	--

## Déclenchement direct du blow-out

Le cas échéant, le dépassement de course (blow-out) peut être directement déclenché.

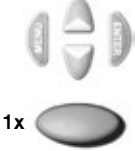





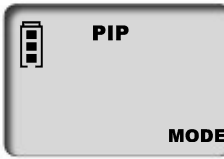

<p><b>1. Appel de la fonction blow-out</b></p>	<p>Appuyer sur la touche ENTER. L'écran affiche «<b>blo</b>» pour blow-out.</p>		
--	---	--	---

<p><b>2. Déclenchement du dépassement de course</b></p>	<p>Pour déclencher le dépassement de course, il suffit d'appuyer une fois sur la touche pipetage. L'écran retourne au mode pipetage programmé (écran initial).</p>		
---	--	---	--

### Remarque:

Lors du dépassement de course (blow-out), les pistons descendent complètement. S'assurer que le liquide résiduel peut être éjecté sans danger. **En maintenant la touche pipetage enfoncée, les pistons s'arrêtent en bas et empêchent ainsi une aspiration accidentelle de liquide. Après l'avoir relâchée, les pistons retournent en écran initial.**

Le programme par défaut, un volume programmé auparavant est aspiré puis éjecté. Le réglage du volume et de la vitesse sont décrits en pages 84 et 85.

Que dois-je faire?	Comment procéder?	Quelle touche?	Qu'affiche l'écran?
1. Appel de la sélection du menu	Pour accéder à la sélection du programme, il suffit d'appuyer trois fois sur la touche MENU. « <b>Mode</b> » clignote.	3x 	
2. Réglage du mode PIPmix	Feuilleter les modes à l'aide des touches flèches jusqu'à ce que « <b>PIPmix</b> » s'affiche. « <b>Mode</b> » clignote toujours.		
3. Confirmation du mode PIPmix	Appuyer sur la touche ENTER. L'écran affiche maintenant « <b>blo</b> » pour « <b>blow-out</b> » (dépassement de course).	 1x	
4. Préparation du pipetage	En appuyant une fois sur la touche pipetage, les pistons sont avancés en écran initial. La flèche sur l'écran pointe vers le haut (aspiration).	 1x	
5. Aspiration du liquide	Pour aspirer le liquide, il suffit d'appuyer une fois sur la touche pipetage.	 1x	

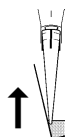

Que dois-je faire?

Comment procéder?

Quelle touche?

Qu'affiche l'écran?

## 6. Ejection du liquide en mode PIPmix

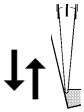

En maintenant la touche pipetage enfoncée, le liquide est aspiré puis éjecté en permanence. Sur l'écran, les flèches d'aspiration et d'éjection s'affichent en alternance avec le nombre de cycles.



maintenir enfoncée



## 7. Achèvement du pipetage

En appuyant une fois sur la touche pipetage, le liquide est éjecté et le dépassement de course est déclenché (blow-out).

Après éjection du liquide résiduel (dépassement de course), l'écran retourne au mode programmé (écran initial).

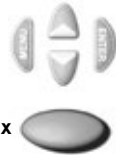









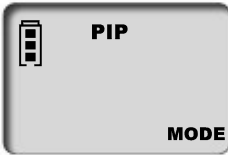

1x

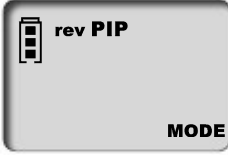





### Remarque:

L'écran affiche au maximum 19 cycles.

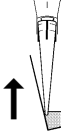
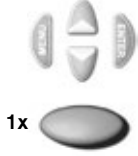
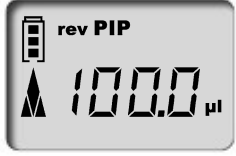
Programme spécial pour le pipetage liquides à viscosité élevée, à tension de pression élevée ou à fluides effervescents. Le réglage du volume et de la vitesse sont décrits en pages 84 et 85.

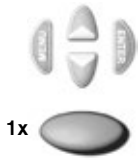
Que dois-je faire?	Comment procéder?	Quelle touche?	Qu'affiche l'écran?
1. Appel de la sélection du menu	Pour accéder à la sélection du programme, il suffit d'appuyer trois fois sur la touche MENU. «Mode» clignote.	3x 	
2. Réglage du mode revPIP	Feuilleter les modes à l'aide des touches flèches jusqu'à ce que «revPIP» s'affiche. «Mode» clignote toujours.		
3. Confirmation du mode revPIP	Appuyer sur la touche ENTER. L'écran affiche maintenant «blo» pour «blow-out» (dépassement de course).		
4. Préparation du pipetage	En appuyant une fois sur la touche pipetage, les pistons sont avancés en écran initial. La flèche sur l'écran pointe vers le haut (aspiration).		
5. Absorption du liquide	Pour aspirer le liquide, il suffit d'appuyer une fois sur la touche pipetage.		
6. Ejection du liquide en mode revPIP	Pour éjecter le liquide, appuyer une fois sur la touche pipetage. Sur l'écran, la flèche pointe vers le bas. Le volume programmé est éjecté et un quantité infime de liquide reste dans les pointes.		









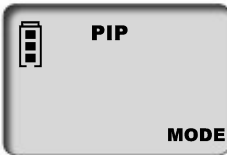

Que dois-je faire?	Comment procéder?	Quelle touche?	Qu'affiche l'écran?
<p><b>7. Réaspiration du liquide en mode revPIP</b></p> 	<p>En appuyant à nouveau sur la touche pipetage, le volume programmé est à nouveau aspiré (une nouvelle pression sur la touche pipetage et le liquide est éjecté, etc.).</p>		
<p><b>8. Déclenchement du dépassement de course</b></p>	<p>Après le dernier pipetage, appuyer sur la touche ENTER. L'écran affiche à nouveau «<b>blo</b>» pour blow-out (dépassement de course).</p>		
	<p>En appuyant une fois sur la touche pipetage, le dépassement de course (blow-out) est déclenché et le liquide résiduel est éjecté.</p>		
<p><b>9. Achèvement du pipetage</b></p>	<p>Après éjection du liquide résiduel (dépassement de course), l'écran retourne au mode programmé (écran initial).</p>		

# Mode électrophorèse (GEL) Les programmes · Réglage et manipulation

Programme permettant de charger les gels électrophorèse.







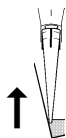

Un volume programmé au préalable est aspiré à grande vitesse puis éjecté lentement.

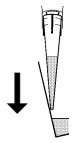
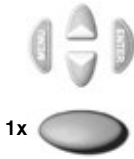
Le réglage du volume et de la vitesse sont décrits en pages 84 et 85.

Que dois-je faire?	Comment procéder?	Quelle touche?	Qu'affiche l'écran?
1. Appel de la sélection du menu	Pour accéder à la sélection du programme, il suffit d'appuyer trois fois sur la touche MENU. «Mode» clignote.	3x 	
2. Réglage du mode GEL	Feuilleter les modes à l'aide des touches flèches jusqu'à ce que «GEL» s'affiche. «Mode» clignote toujours.		
3. Confirmation du mode GEL	Appuyer sur la touche ENTER. L'écran affiche maintenant «blo» pour «blow-out» (dépassement de course).	 1x	
4. Préparation du pipetage	En appuyant une fois sur la touche pipetage, les pistons sont avancés en écran initial. La flèche sur l'écran pointe vers le haut (aspiration).	 1x	
5. Aspiration du liquide	Pour aspirer le liquide, il suffit d'appuyer une fois sur la touche pipetage. Le volume programmé est alors aspiré.	 1x	
	<b>Aspiration d'un volume supérieur</b> Afin d'aspirer plus de liquide que programmé (jusqu'à 110 % du volume nominal), maintenir la touche pipetage enfoncée durant l'aspiration jusqu'à ce que le volume souhaité ait été aspiré.	 maintenir enfoncée	

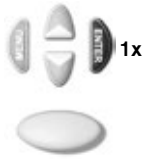

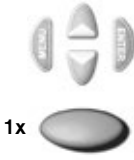









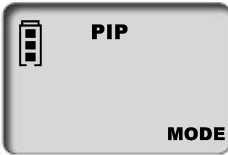

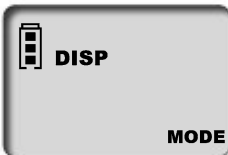

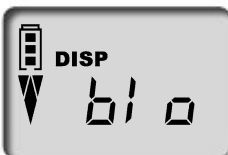







Que dois-je faire?	Comment procéder?	Quelle touche?	Qu'affiche l'écran?
<b>6. Ejection du liquide en mode GEL</b>  	Afin d'éjecter le liquide, appuyer un court instant sur la touche pipetage, un dièse s'affiche sur l'écran. Le volume programmé est lentement éjecté.		
	<b>Interrompre l'éjection</b> L'éjection de l'échantillon peut être interrompue en appuyant à nouveau sur la touche pipetage. L'écran affiche alors le volume de liquide éjecté.		
<b>7. Déclenchement du dépassement de course</b>	Après le dernier pipetage, appuyer sur la touche ENTER. L'écran affiche à nouveau «blo» pour blow-out (dépassement de course).		
	En appuyant une fois sur la touche pipetage, le dépassement de course (blow-out) est déclenché et le liquide résiduel est éjecté.		
<b>8. Achèvement du pipetage</b>	Après éjection du liquide résiduel (dépassement de course), l'écran retourne au mode programmé (écran initial).		

**Remarque:**

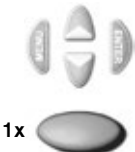
Le mode GEL implique la mise en œuvre d'une très lente éjection afin d'éviter de soumettre les échantillons à des tourbillonnements. Afin de garantir une éjection optimale, la vitesse d'éjection a été réglée en usine. Elle est nettement plus lente que la vitesse 1 et ne peut pas être sélectionnée individuellement.

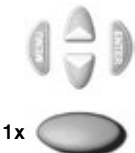
Programme permettant la distribution d'un volume de liquide en plusieurs fractions.  
Il y a plus de liquide aspiré que nécessaire selon le calcul.  
Le réglage de la vitesse est décrit en page 85

Que dois-je faire?	Comment procéder?	Quelle touche?	Qu'affiche l'écran?
1. Appel de la sélection du menu	Pour accéder à la sélection du programme, il suffit d'appuyer trois fois sur la touche MENU. «Mode» clignote.	3x 	
2. Réglage du mode DISP	Feuilleter les modes à l'aide des touches flèches jusqu'à ce que «DISP» s'affiche. «Mode» clignote toujours.		
3. Confirmation du mode DISP	Appuyer sur la touche ENTER. L'écran affiche maintenant «blo» pour «blow-out» (dépassement de course).	 1x	
4. Préparation du dosage	En appuyant une fois sur la touche pipetage, les pistons sont avancés en écran initial. La flèche sur l'écran pointe vers le haut (aspiration).	 1x	
5. Réglage du volume de la fraction	Pour augmenter le volume, il suffit d'appuyer sur la touche flèche (+). Une pression prolongée augmente la vitesse de défilement du volume. «VOL» clignote toujours.		
6. Confirmation du volume de la fraction	Appuyer sur la touche ENTER. L'écran affiche le nouveau volume de la fraction programmé. «steps» clignote. Le nombre maximal de fractions s'affiche.	 1x	

Que dois-je faire?	Comment procéder?	Quelle touche?	Qu'affiche l'écran?
7. Réglage du nombre de fractions	En appuyant sur la touche (+/-) on peut régler le nombre de fractions. «steps» clignote toujours.		
8. Confirmation du nombre de fractions	Appuyer sur la touche ENTER. L'écran affiche le nombre de fractions.		
9. Aspiration du liquide	Pour aspirer le liquide, il suffit d'appuyer une fois sur la touche pipetage.		
10. Ejection du liquide	En appuyant la touche pipetage une fraction est éjectée. La flèche sur l'écran pointe vers le bas (éjection). Le nombre de fractions disponibles s'affiche.		
11. Déclenchement du dépassement de course	Après la dernière distribution, appuyer sur la touche ENTER. L'écran affiche «blo» pour blow-out (dépassement de course). En appuyant une fois sur la touche pipetage, le dépassement de course est déclenché (voir page 95).		
12. Achèvement du dosage	Après éjection du liquide résiduel (dépassement de course), l'écran retourne au mode programmé (écran initial).		

# Contrôle du volume

En fonction de l'usage, nous recommandons de faire contrôler l'appareil tous les 3 à 12 mois. Mais le cycle peut être adapté aux exigences individuelles.

L'essai volumétrique gravimétrique des pipettes s'effectue de la manière suivante et satisfait aux exigences de la 6ème partie de la norme DIN EN ISO 8655.

## 1. Réglage du volume nominal

Mettre au volume maximum de l'appareil.  
Déroulement, voir page 84.

## 2. Conditionnement de la pipette

Conditionner la pipette avant l'essai en aspirant et éjectant cinq fois le liquide d'essai (H<sub>2</sub>O dist.) à l'aide des pointes de la pipette. Jeter ensuite les pointes de la pipette.

## 3. Réalisation de l'essai

- Insérer des nouvelles pointes sur la pipette et les rincer une fois à l'aide du liquide d'essai.
- Aspirer le liquide puis l'éjecter dans le récipient de pesée.

**Remarque:** Chaque canal individuel doit être contrôlé séparément.

- Peser ensuite la quantité pipetée à l'aide d'une balance chimique (veuillez observer le mode d'emploi du fabricant de la balance).
- Calculer le volume pipeté. Tenir compte de la température.
- Il est recommandé d'effectuer 3-10 pipetages et pesées par canal dans 3 plages de volume (100 %, 50 %, 10 %).

### Calcul (volume nominal)

$x_i$  = résultats des pesages  
 $n$  = nombre de pesages

$Z$  = facteur de correction  
(par ex. 1,0029 µl/mg à 20 °C, 1013 hPa)

Valeur moyenne  $\bar{x} = \frac{\sum x_i}{n}$

Volume moyen  $\bar{V} = x \cdot Z$

### Exactitude\*

$$E\% = \frac{\bar{V} - V_0}{V_0} \cdot 100$$

$V_0$  = volume nominal

### Déviatión standard

$$s = Z \cdot \sqrt{\frac{\sum (x_i - \bar{x})^2}{n - 1}}$$

### Coefficient de variation\*

$$CV\% = \frac{100 s}{\bar{V}}$$

\*) = calcul de l'exactitude (E%) et du coefficient de variation (CV%):

E% et CV% seront calculés selon les formules utilisés pour le contrôle statistique de qualité.

Les valeurs d'essai finales se rapportent au volume nominal imprimé sur l'appareil (= volume maxi) et aux volumes de la fraction indiqués à température identique (20 °C) de l'appareil, de l'environnement et de l'eau distillée Conformément aux exigences de la norme DIN EN ISO 8655.

CE



20 °C  
Ex

## Précision de la Transferpette®-8/-12 electronic

Gamme de volume µl	Volume de la fraction µl	E* ≤ ± %	CV* ≤ %	Pas inter-médiares µl	Type de pointe rec., µl
0,5 - 10	10	1,2	0,8	0,01	0,5 - 20
	5	2,0	1,5		
	1	8,0	4,0		
1 - 20	20	1,0	0,5	0,02	0,5 - 20
	10	2,0	1,0		
	2	8,0	3,0		
5 - 100	100	0,8	0,25	0,1	2 - 200
	50	1,6	0,4		
	10	4,0	1,5		
10 - 200	200	0,8	0,25	0,2	2 - 200
	100	1,4	0,4		
	20	4,0	1,3		
15 - 300	300	0,6	0,25	0,5	5 - 300
	150	1,2	0,4		
	30	3,0	1,2		

\* E = exactitude, CV = coefficient de variation

### Remarque:

Des instructions de contrôle (SOPs) et une version de démonstration du logiciel de calibrage EASYCAL™ 4.0 peuvent être téléchargées sur le site [www.brand.de](http://www.brand.de).

## Le mode d'ajustage «CAL»

### Ajustage

Le volume nominal, resp. le volume à contrôler, est programmé. Pipetage en mode par défaut (PIP), 100,0 µl, par ex. (procédure, voir pages 84/88). Par. ex.: volume en relation avec l'essai volumétrique 101,3 µl.



### Que dois-je faire?

### Comment procéder?

### Quelle touche?

### Qu'affiche l'écran?

#### 1. Appel du mode CAL

Pour appeler le mode CAL, il suffit de maintenir la touche MENU enfoncée (> 3 s). L'écran affiche «off». «CAL» clignote.

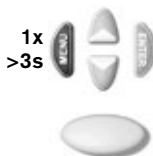

#### 2. Activation du mode CAL

Le mode CAL s'active en appuyant sur l'une des touches flèches. L'écran affiche alors «on». «CAL» clignote toujours.

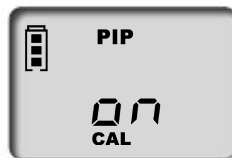

#### 3. Confirmation du mode CAL

Appuyer sur la touche ENTER. L'écran affiche ensuite à nouveau le volume de pipetage programmé. «CAL» clignote.



#### 4. Réglage du volume

Régler le volume déterminé et contrôlé à l'aide des touches flèches (+/-). «CAL» clignote.



#### 5. Confirmation du volume

Appuyer sur la touche ENTER. Le volume contrôlé et corrigé s'affiche sur l'écran. Le symbole CAL affiché en permanence atteste de l'ajustage effectué.



## Restauration de l'état à la livraison

Le symbole CAL affiché en permanence sur l'écran signale la présence d'un ajustage.



### Que dois-je faire?

### Comment procéder?

### Quelle touche?

### Qu'affiche l'écran?

#### 1. Appel du mode CAL

Pour appeler le mode CAL, il suffit de maintenir la touche MENU enfoncée (> 3 s). L'écran affiche «on». «CAL» clignote.

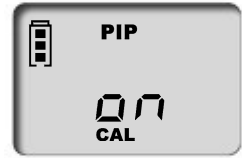
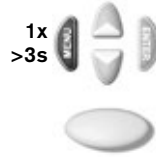

#### 2. Désactivation du mode CAL

Le mode CAL se désactive en appuyant sur l'une des touches flèches. L'écran affiche alors «off». «CAL» clignote toujours.



#### 3. Restauration de l'état à la livraison

Appuyer sur la touche ENTER. Le symbole CAL affiché en permanence s'est effacé. L'appareil se trouve de nouveau à l'état de livraison.



### Important:

Lors de l'ajustage de la Transferpette®-8/-12 electronic, un off-set de volume est réalisé. Cela signifie que le volume se modifie d'autant dans l'ensemble de la plage de volume de la pipette. Il est recommandé d'effectuer l'ajustage à 50 % du volume nominal.

### Remarque:

Cet appareil est ajusté en permanence pour les solutions aqueuses mais peut également être ajusté à différentes densités, viscosités et températures. La Transferpette®-8/-12 electronic peut être ajustée dans tous les modes (à l'exception du mode GEL).

## Autoclavage

La partie pipetage (P) mise en relief de la Transfertette®-8/-12 electronic est autoclavable à 121 °C (2 bares) et une durée de maintien d'au moins 15 minutes selon DIN EN 285.

**Attention:** La poignée n'est pas autoclavable!

1. Jeter les pointes de la pipette.
2. Dévisser la partie pipetage de la pipette (voir page 104).
3. Autoclaver la partie pipetage complète de la pipette sans rien démonter de plus.
4. Laisser complètement refroidir et sécher la partie pipetage.
5. Visser de nouveau la partie pipetage sur la poignée (voir page 104).
6. Effectuer une course d'essai (rEF).

**Remarque:** L'efficacité de l'autoclavage doit être contrôlée par l'utilisateur. Une sécurité élevée est atteinte par stérilisation sous vide. Nous conseillons l'utilisation de poches de stérilisation.

En cas d'autoclavage fréquent de la partie pipetage, il est recommandé de lubrifier le piston à l'aide de la graisse de silicone fournie.

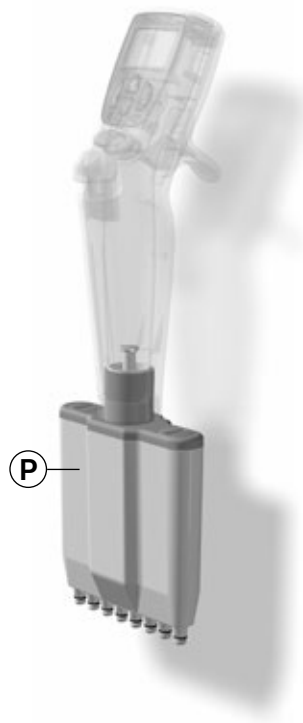

## Course de référence (rEF)

Avant de remplacer la partie pipetage, réaliser une course d'essai. Elle permet de garantir le couplage sûr de piston.

Que dois-je faire?	Comment procéder?	Quelle touche?	Qu'affiche l'écran?
1. Appel du mode rEF	Pour activer le mode rEF, il suffit d'appuyer simultanément les touches MENU et ENTER.	1x	PIP rEF
2. Exécution de la course d'essai	La course d'essai se déclenche en appuyant une fois sur la touche pipetage. Un bruit est nettement audible.	1x	PIP rEF

**Remarque:** Après la course d'essai, l'écran affiche automatiquement le programme sélectionné auparavant.



Les trois principaux composants de la partie pipetage sont facilement séparés et démontés pour permettre l'entretien, le nettoyage ou le remplacement des pièces. La procédure est clairement expliquée dans les pages suivantes.

**Remarque:** Le changement des joints à lèvres/anneau torique sur les tiges individuelles est décrit de manière détaillée dans le mode d'emploi joint à la pièce de rechange.

## Principaux composants de la partie pipetage

- A Dispositif de pistons** avec support des paliers de piston [ I ] et les pistons qui y sont insérés, qui peuvent être dévissés individuellement pour le nettoyage ou l'échange
- B Groupement de tiges** avec support des paliers de tige [ II ] et l'axe central de guidage (Z) fixé à celui-ci, ainsi que les tiges, qui peuvent être dévissées individuellement pour le nettoyage ou l'échange
- C Boîtier de la partie pipetage**, qui est fixé au couvercle du boîtier pipetage [ III ] du dispositif de pistons par deux fermetures rotatives

## Entretien

Afin de fonctionner parfaitement, la Transferpette®-8/-12 electronic doit être entretenue et, le cas échéant, nettoyée à intervalles réguliers.

### Que faut-il contrôler?

1. Contrôler l'absence de détérioration et d'encrassement au niveau des tiges de la pipette, des pistons et des joints.
2. Contrôlez l'étanchéité de l'appareil. Nous conseillons employer l'appareil de contrôle d'étanchéité BRAND PLT unit. Alternatif: pour ce faire, aspirer l'échantillon puis tenir l'appareil à la verticale pendant env. 10 s. Lorsqu'une goutte se forme à l'extrémité de la pointe de la pipette: consulter la section «Dérangement – que faire? en page 110.

## Instructions de nettoyage (page 104-107)

1. Nettoyer les tiges individuelles, les pistons et le support des paliers de piston (**seulement ces pièces**) avec une solution savonneuse ou de l'isopropanol, puis rincer avec de l'eau distillée.
2. Laisser complètement sécher et refroidir les pièces. Des résidus de liquide dans les tiges réduisent l'exactitude.
3. Graisser légèrement les pistons en utilisant graisse de silicone fournie. Pour lubrifier l'axe central de guidage (Z), utiliser exclusivement la graisse fluorée prescrite!
4. Après le montage de l'appareil, effectuer une course de référence (REF).

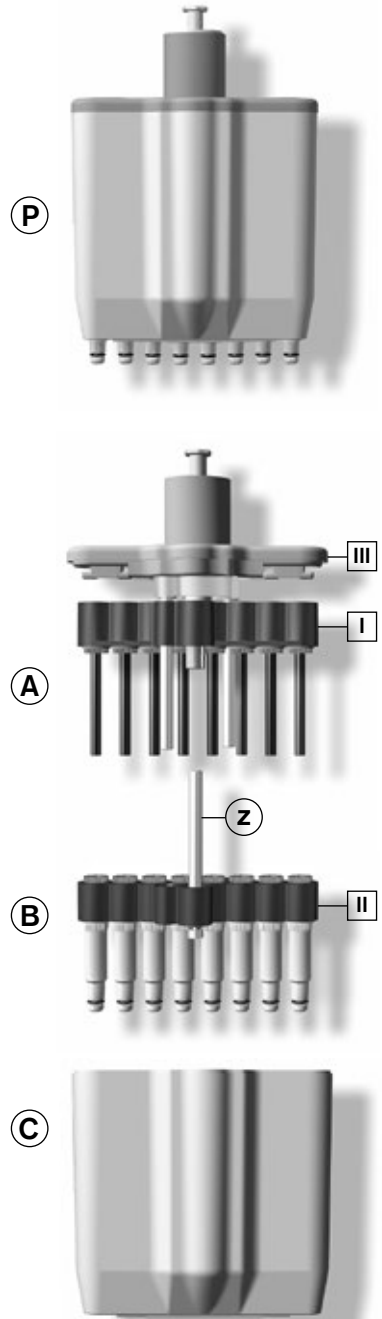

## Entretien et nettoyage

### Séparation de la poignée de la partie pipetage

1. Démontez les pointes de pipettes.
2. Pour découpler la partie pipetage, tirez vers le bas autant que possible **ensuite seulement** tournez dans le sens des aiguilles d'une montre. Après le premier tour il n'est plus nécessaire de tirer vers le bas.
3. Une fois la partie pipetage dévissée, tirez vers le bas pour défaire la connexion magnétique.

### Remarque:

La partie pipetage doit être vissée sur la poignée dans le sens inverse des aiguilles d'une montre jusqu'à ce qu'elle s'enclenche avec un déclic. Ne pas tirer la partie pipetage vers le bas lors du montage.

### Attention:

Tout traitement inapproprié peut causer des dommages!



### Démontage des tiges et des joints d'étanchéité pour le nettoyage ou l'échange.

1. **Dévisser la partie pipetage** Dévisser la partie pipetage de la partie poignée.

2. **Retirer le boîtier de la partie pipetage** Défaire les deux fermetures du couvercle du boîtier pipetage en les tournant d'un quart de tour. Retirer le boîtier de la partie pipetage.

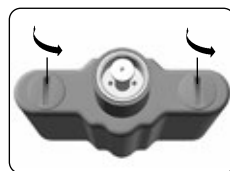

3. **Démonter la tige** Enfiler la clé de montage sur la tige individuelle puis dévisser et démonter la tige.

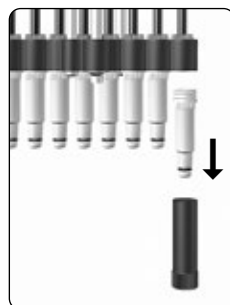

## 4. Retirer le joint

Pousser complètement le dispositif de pistons vers le bas. Retirer et contrôler le joint d'étanchéité, et le cas échéant, le nettoyer ou le remplacer

### Remarque:

Après avoir enlevé la tige, le joint reste dans la tige ou se trouve sur le piston.

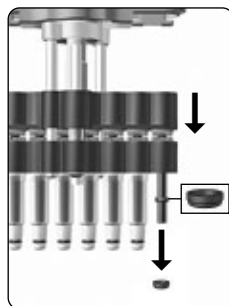

## 5. Remonter le joint

Si besoin est, graisser légèrement le piston en utilisant la graisse silicone fournie avec l'appareil. Glisser le joint d'étanchéité sur le piston, le côté aplati vers le haut. Visser la tige nettoyée ou neuve avec la clé de montage.

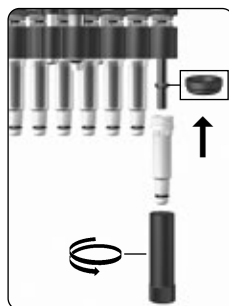

## 6. Remonter la partie pipetage

Remonter la partie pipetage et la fixer à la poignée.

### Remarque:

La partie pipetage doit être vissée sur la poignée dans le sens inverse des aiguilles d'une montre jusqu'à ce qu'elle s'enclenche avec un déclic.

Ne pas tirer la partie pipetage vers le bas lors.

Vérifier l'étanchéité, la maniabilité et précision de l'appareil (voir page 103, «Entretien»).

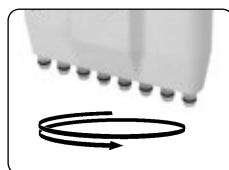

## 7. Exécution de la course d'essai

Exécution de la course d'essai (rEF).

# Entretien et nettoyage

## Démontage des pistons pour le nettoyage ou l'échange

1. **Dévisser la partie pipetage** Dévisser la partie pipetage de la partie poignée (Voir p. 104).

2. **Retirer le boîtier de la partie pipetage** Défaire les deux fermetures du couvercle du boîtier pipetage en les tournant d'un quart de tour. Retirer le boîtier de la partie pipetage.

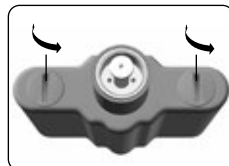

3. **Elever formes** Enlever les deux vis cruciformes extérieures du groupement des tiges.

**Attention:**

Ne jamais défaire l'axe central de guidage (Z).

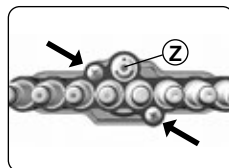

4. **Séparer la partie pistons de la partie tiges** Effectuer une traction opposée et séparer la partie pistons de la partie tiges.

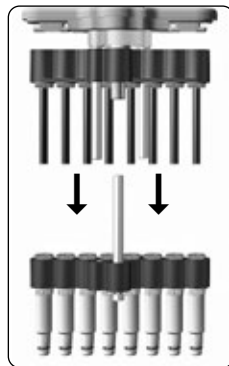

5. **Elever le piston** Enfiler la clé de montage sur l'écrou du piston et dévisser l'écrou du piston. Démontez l'écrou du piston et retirez le piston.

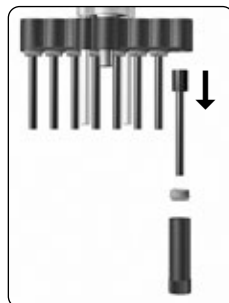

## 6. Monter le piston

Monter le piston nettoyé ou neuf et revisser l'écrou du piston avec la clé de montage.

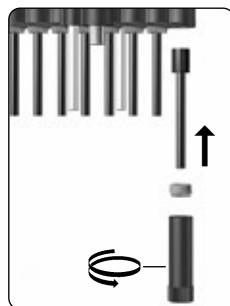

## 7. Monter la partie tiges et la partie pistons

Désserrer les tiges en les tournant un demitour. Ensuite enfiler le groupement de tiges sur le dispositif de pistons et le fixer. Visser les tiges.

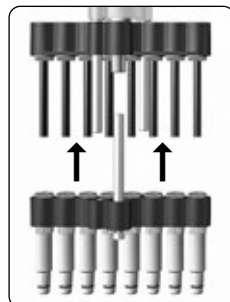

## 8. Remonter la partie pipetage

Remonter la partie pipetage et la fixer à la poignée.

### Remarque:

La partie pipetage doit être vissée dans le sens inverse des aiguilles d'une montre sur la poignée jusqu'à ce qu'elle s'enclenche avec un déclic. Ne pas tirer la partie pipetage vers le bas lors.

Vérifier l'étanchéité, la maniabilité et précision de l'appareil (voir page 103, «Entretien»).

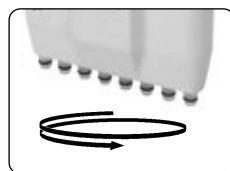

## 9. Exécution de la course d'essai

Exécution de la course d'essai (rEF).

## Recharge et remplacement de la pile

Une pile complètement chargée permet de pipeter en permanence des échantillons à viscosité et densité proches de l'eau durant env. 8 heures.

### Attention:

Avant de recharger la pile, il est impératif de s'assurer que le bloc d'alimentation convient pour la tension disponible dans le laboratoire. L'appareil ne doit pas être stocké dans les environnements exposés aux explosions. La pile doit uniquement être rechargée dans la Transferpette®-8/-12 electronic!

### Recharge de la pile

- Insérer le connecteur du câble de charge dans la prise prévue à cet effet sur le haut de la Transferpette®-8/-12 electronic. La recharge débute automatiquement.
- Durant la recharge, les barres de l'indicateur de charge de la pile défilent en permanence de haut en bas. La pile est complètement rechargée lorsque les barres de l'affichage ne défilent plus.

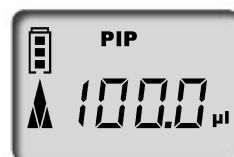

### Pipetage durant la recharge?

Durant la recharge, vous pouvez poursuivre votre travail avec la Transferpette®-8/-12 electronic.

Lorsque la pile est complètement déchargée, il faut néanmoins patienter quelques minutes jusqu'à ce que la capacité de charge minimale soit atteinte pour pouvoir garantir une utilisation sûre.

### Remarque:

Les derniers réglages effectués sont mémorisés sur l'EEPROM de l'appareil. Ils sont conservés même en cas de décharge totale ou de remplacement de la pile!

### Remplacement de la pile

- Ouvrir le couvercle du logement de la pile, retirer la pile puis retirer la fiche de la prise.
- Enfoncer la fiche de la pile neuve dans la douille enfichable puis insérer la pile neuve.
- Remettre en place puis refermer le couvercle du logement de la pile.



Durant les pauses, retirer la pile de l'appareil.

## Recharge et remplacement de la pile

### Affichage de la pile après remplacement

- a) Après insertion de la pile, la **capacité maximale** s'affiche **dans un cadre clignotant** (l'appareil ne reconnaît pas immédiatement l'état de charge). Après 3,5 h de charge – charge maximale sûre de la pile – le cadre arrête de clignoter.



### Remarque:

Après la première mise en place charger pendant 3,5 h. La capacité de charge maximale est atteinte après plusieurs cycles de recharge/ décharge.

## Fonction de régénération de la pile

### (fonction Refresh)

Afin de prolonger la durée de vie et d'augmenter le rendement de la pile, la Transferpette®-8/-12 electronic dispose d'une fonction de régénération (fonction Refresh). Cette fonction permet la charge et de la décharge complète de la pile à cycles automatiques. Afin d'optimiser le rendement de la pile, effectuer de temps à autre la fonction Refresh.

### Exécution de la fonction Refresh

- a) Insérer le connecteur (branchement) du bloc d'alimentation dans la douille prévue à cette effet sur le haut de la Transferpette®-8/-12 electronic



- b) Appuyer sur la touche flèche inférieure pendant 3 s minimum. Durant la décharge, les barres d'indication défilent en permanence de haut en bas



- c) Après la décharge (3 h maxi), la procédure de charge démarre automatiquement (3,5 h). Durant la procédure de recharge, les barres d'indication de la charge défilent de haut en bas.







### Interruption de la fonction Refresh

En appuyant sur une touche quelconque, le programme est interrompu. L'appareil commute automatiquement en mode de pipetage par défaut (PIP) et retourne au volume nominal et la procédure de recharge normale débute automatiquement (voir page 108). Le débranchement de la fiche secteur interrompt également le programme.



Ne pas interrompre la fonction "Refresh" à la fin du cycle de décharge.

## Dérangement – que faire?

En cas de panne, l'appareil affiche «Err» et le numéro d'erreur sur l'écran. L'appareil ne réagit plus qu'à la touche ENTER. Après avoir actionné la touche ENTER, l'appareil tente de redémarrer. Il demande donc automatiquement une course d'essai (rEF).

Dérangement	Message d'erreur	Cause possible	Que faire?
L'appareil ne réagit pas		Pile vide ou défectueuse	Charger la pile durant 5 min. mini. sans actionner l'appareil puis pour suivre le travail avec le câble de recharge jusqu'à ce que la pile soit rechargée. Le cas échéant, remplacer la pile.
		Composant électronique défectueux	Envoyer l'appareil en réparation.
L'appareil ne réagit pas		Composant électronique défectueux	Envoyer l'appareil en réparation
L'appareil ne réagit pas		Erreur de programme imprévue	Acquittement de l'erreur en actionnant la touche ENTER, l'appareil est réinitialisé.
L'appareil ne réagit pas		Composant électronique défectueux	Envoyer l'appareil en réparation
Aucun affichage sur l'écran	—	Décharge électrostatique	Enlever l'accumulateur puis le replacer
		Composant électronique défectueux	Envoyer l'appareil en réparation.
Pointe goutte/l'appareil n'est pas étanche ou erreur de volume	—	Pointe inadéquate	Employer uniquement des pointes de qualité
		La pointe n'est pas fixée correctement	Enfoncer la pointe plus solidement
		Piston, tige au joint d'étanchéité encrassé ou endommagé	Nettoyer l'appareil/remplacer joint d'étanchéité Graisser le piston.
Le liquide n'est pas aspiré ou fort bruit de moteur	—	Course réduit du piston	Dévisser la partie pipetage et bouger la pièce métallique central avec la main.



Marquage	Signification
	Par ce label, nous confirmons que le produit correspond aux exigences spécifiées dans les directives CE et qu'il a été soumis aux procédures de contrôle définies.
	L'appareil est conforme à la loi allemande relative à l'étalonnage et à la mesure ainsi qu'aux normes d'étalonnage et de mesure. Succession de caractères DE-M (DE pour l'Allemagne), encadrée par un rectangle ainsi que les deux derniers chiffres de l'année au cours de laquelle le marquage a été apposé (ici: 2020).
<b>XXZXXXXX</b>	Numéro de série
	Veillez tenir compte des indications se trouvant sur l'appareil, sur les accessoires et dans le mode d'emploi.
	L'appareil ou la batterie doit être jeté/évacué dans les règles de l'art.
	Respecter le mode d'emploi.
	China RoHS (EFUP) L'EFUP définit la période en années durant laquelle les substances dangereuses contenues dans les appareils électriques et électroniques ne s'écoulent pas ou ne mutent pas sous des conditions d'utilisation normales. En cas d'utilisation normale par l'utilisateur, de tels produits électriques et électroniques ne causent pas de graves souillures causées à l'environnement, de graves blessures corporelles ou d'endommagements des valeurs matérielles de l'utilisateur.
	L'appareil électrique ne doit pas être jeté à la poubelle contenant des ordures ménagères.

## Transferpette®-8 electronic, bloc d'alimentation fourni (100-240V/50-60 Hz)

Volume	0,5-10 µl	1-20 µl	5-100 µl	10-200 µl	15-300 µl
	Réf.	Réf.	Réf.	Réf.	Réf.
pour Europe (continent.)	7053 99	7054 00	7054 03	7054 04	7054 06
pour UK/Irlande	7054 09	7054 10	7054 13	7054 14	7054 16
pour USA/Japon	7054 19	7054 20	7054 23	7054 24	7054 26
pour Australie	7054 29	7054 30	7054 33	7054 34	7054 36

## Transferpette®-12 electronic, bloc d'alimentation fourni (100-240V/50-60 Hz)

Volumen	0,5-10 µl	1-20 µl	5-100 µl	10-200 µl	15-300 µl
	Réf.	Réf.	Réf.	Réf.	Réf.
pour Europe (continent.)	7054 49	7054 50	7054 53	7054 54	7054 56
pour UK/Irlande	7054 59	7054 60	7054 63	7054 64	7054 66
pour USA/Japon	7054 69	7054 70	7054 73	7054 74	7054 76
pour Australie	7054 79	7054 80	7054 83	7054 84	7054 86

## Blocs d'alimentation (100-240V/50-60 Hz)

Description	Réf.
pour Europe (continent.)	7053 50
pour UK/Irlande	7053 51
pour USA/Japon	7053 52
pour Australie	7053 53

## Pièces de rechange pour la Transferpette®-8/-12 electronic

Design et dimensions des pièces de rechange conformément au volume nominal correspondant (illustration pièces de rechange de la Transferpette®-8/-12 electronic 5-100 µl)

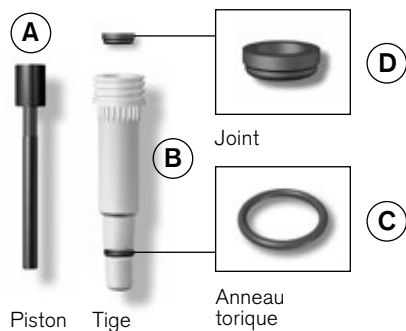

Volume	A	B*	C	D
0,5 - 10 µl	7056 59	7056 77	7033 80	7033 40
1 - 20 µl	7056 71	7056 78	7033 80	7033 41
5 - 100 µl	7056 62	7056 15	7056 18	7033 44
10 - 200 µl	7056 63	7056 16	7056 18	7033 45
15 - 300 µl	7056 64	7056 17	7056 18	7033 46

\* y compris joint d'étanchéité, anneau torique et clé de montage

### Pointes de pipette de qualité de BRAND, en rack, en TipBox

Volume	Quantité de tips	Réf.
0,1 - 20 µl	480	7322 02
0,5 - 20 µl	480	7322 04
2 - 200 µl	480	7322 08
5 - 300 µl	480	7322 10

### Autres accessoires

Description	Réf.
Pille de rechange	7055 00
Graisse de silicone	7036 77
Graisse fluorée	7036 78
PLT unit	7039 70

### Envoyer en réparation

**Attention:** Transporter des matériaux dangereux sans autorisation est interdit par la loi.

- Nettoyer et décontaminer soigneusement l'appareil.
- Veuillez renvoyer l'appareil, de principe joindre une description précise du type de dysfonctionnement et des fluides utilisés. Si les liquides utilisés ne sont pas indiqués, l'instrument ne peut pas être réparé.
- Tout retour est aux périls et aux frais de l'expéditeur.

### En dehors des États-Unis et de Canada:

- Remplir l'«Attestation de Décontamination» et la retourner avec l'appareil au fabricant ou au fournisseur. Demander le formulaire au fournisseur ou au fabricant ou bien en téléchargement gratuit sous [www.brand.de](http://www.brand.de).

### Aux États-Unis et au Canada:

- Veuillez contacter BrandTech Scientific, Inc. pour demander les conditions de retour de l'appareil **avant** de le renvoyer au service après-vente.
- Veuillez renvoyer seulement les appareils dûment nettoyés et décontaminés, avec le numéro d'autorisation de retour bien en évidence sur l'extérieur de l'emballage, à l'adresse indiquée avec le numéro d'autorisation de retour.

### Adresses de contact

#### BRAND GMBH + CO KG

Otto-Schott-Straße 25  
97877 Wertheim (Germany)  
Tel.: +49 9342 808-0  
Fax: +49 9342 808-98000  
E-Mail: [info@brand.de](mailto:info@brand.de)  
[www.brand.de](http://www.brand.de)

#### États-Unis et Canada:

BrandTech® Scientific, Inc.  
11 Bokum Road  
Essex, CT 06426-1506 (USA)  
Tel.: +1-860-767 2562  
Fax: +1-860-767 2563  
[www.brandtech.com](http://www.brandtech.com)

#### Inde:

BRAND Scientific Equipment Pvt. Ltd.  
303, 3rd Floor, 'C' Wing, Delphi  
Hiranandani Business Park, Powai  
Mumbai - 400 076 (India)  
Tel.: +91 22 42957790  
Fax: +91 22 42957791  
E-Mail: [info@brand.co.in](mailto:info@brand.co.in)  
[www.brand.co.in](http://www.brand.co.in)

#### Chine:

BRAND (Shanghai) Trading Co., Ltd.  
Guangqi Culture Plaza  
Room 506, Building B  
No. 2899, Xietu Road  
Shanghai 200030 (P.R. China)  
Tel.: +86 21 6422 2318  
Fax: +86 21 6422 2268  
E-Mail: [info@brand.cn.com](mailto:info@brand.cn.com)  
[www.brand.cn.com](http://www.brand.cn.com)

### Service de calibration

Les normes ISO 9001 et les directives BPL exigent des contrôles réguliers de vos appareils de volumétrie. Nous recommandons de contrôler les volumes régulièrement tous les 3-12 mois. Les intervalles dépendent des exigences individuelles de l'appareil. Plus l'appareil est utilisé et plus les produits sont agressifs, plus les contrôles doivent être fréquents. Les instructions de contrôle détaillés sont disponibles en téléchargement gratuit sur [www.brand.de](http://www.brand.de) ou [www.brandtech.com](http://www.brandtech.com).

BRAND vous offre également la possibilité de faire calibrer vos instruments par notre service de calibration ou par le laboratoire de calibration DAkkS de BRAND.

Envoyer simplement les appareils à calibrer et indiquer, quelle sorte de calibration vous désirez. Vous recevrez vos appareils avec un rapport de calibration (service de calibration BRAND) resp. avec une attestation de calibration DAkkS. Pour des informations détaillées, veuillez vous renseigner auprès de votre fournisseur ou directement chez BRAND. Le document de commande est disponible pour le téléchargement sur [www.brand.de](http://www.brand.de) (voir 'Documents Techniques').

## Garantie

Nous déclinons toute responsabilité en cas de conséquences d'un traitement, d'une utilisation, d'un entretien et d'une manipulation incorrecte, d'une réparation non-autorisée de l'appareil ou d'une usure normale, notamment des pièces d'usure, telles que les pistons, les joints d'étanchéité, les soupapes et de rupture de pièces en verre. Ceci vaut pour l'inobservation du mode d'emploi. Nous déclinons toute responsabilité en cas de dommages résultant d'actions non décrites dans le mode d'emploi ou si des pièces de rechange ou accessoires qui ne sont pas d'origine, ont été utilisés.

États-Unis et Canada:

Des informations sur la garantie figurent sous [www.brandtech.com](http://www.brandtech.com).

## Elimination

---

Le symbole ci-contre signifie qu'à la fin de leur durée de vie, les piles/accus et appareils électroniques ne doivent pas être éliminés avec les ordures ménagères (déchets municipaux non triés).

- Le traitement special des déchets des appareils électroniques doit être effectué selon les réglementations nationales relatives au traitement des déchets selon la directive 2002/96/CE du Parlement européen et du Conseil du 27 janvier 2003 sur les appareils électriques et électroniques usagés.
- Les piles / accus contiennent des substances susceptibles d'avoir un effet nocif sur l'environnement et la santé. Le traitement special de leurs déchets doit être effectué selon les réglementations nationales relatives au traitement des déchets selon la directive 2006/66/CE du Parlement européen et du Conseil du 6 septembre 2006 sur les piles / accus usagés. N'éliminer la pile / accu que quand il est déchargé complètement.

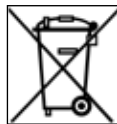

### **Avertissement!**

Ne pas court-circuiter les piles / accus pour les décharger!

	Página
Normas de seguridad	118
Función y limitaciones de empleo	119
Excepciones de uso	119
<b>Elementos de manejo</b>	<b>120</b>
Los primeros pasos	121
Ajuste de volumen	122
Ajuste de la velocidad de aspiración y salida	123
Pipetear correctamente	124
Programas de pipeteado	125
Modo PIP	126
Modo PIPmix	128
Modo revPIP	130
Modo de electroforesis (GEL)	132
Modo DISP	134
Controlar el volumen	136
Tabla de precisión	137
<b>Easy Calibration (Ajustar)</b>	<b>138</b>
Autoclavage	140
Recorrido de referencia (rEF)	140
Mantenimiento y limpieza	141
Cargar y cambiar la batería	146
Función de regeneración de batería	147
¿Qué hacer en caso de avería?	148
Símbolos informativos en el producto	149
Referencias · Accesorios · Recambios	150
Reparación · Direcciones de contacto	152
Service de calibración · Garantía	153
Eliminación	154

## Normas de seguridad

Este aparato puede entrar en contacto con instalaciones, aplicaciones o materiales peligrosos. Estas instrucciones de manejo no tienen por objeto enumerar todas las limitaciones de seguridad que pueden presentarse durante el uso. El usuario del aparato tiene responsabilidad de tomar las medidas suficientes para su seguridad y su salud, así como determinar las limitaciones de uso correspondientes antes de su utilización.

### Rogamos lea este documento cuidadosamente

1. Todo usuario debe haber leído estas instrucciones de manejo antes de utilizar el aparato, y debe seguirlas.
2. Observar las advertencias de peligro y las reglas de seguridad generales, como por ejemplo utilizar vestimenta, protección de los ojos y guantes de protección.  
Al trabajar con muestras infecciosas o peligrosas, deberán seguirse las normativas estándar de laboratorios y tomar las medidas pertinentes.
3. Observar las indicaciones del fabricante de los reactivos.
4. No hacer funcionar el aparato en atmósfera con peligro de explosión. No se deben pipetear medios fácilmente inflamables.
5. El aparato deberá utilizarse exclusivamente para pipetear líquidos cumpliendo siempre con las limitaciones de empleo y excepciones de uso (véase pág. 119). En caso de duda, dirigirse sin falta al fabricante o al distribuidor.
6. Trabajar siempre de tal manera que no corran peligro ni el operador ni otras personas. Evitar salpicaduras y utilizar un recipiente de recogida apropiado.
7. Al trabajar con medios agresivos, evitar el contacto con la abertura de las puntas.
8. No emplear nunca la fuerza.
9. Utilizar sólo recambios originales. No efectúe ninguna modificación técnica. ¡No desmonte el aparato más allá de lo descrito en las instrucciones de manejo!
10. Antes de cada uso, comprobar el estado correcto de aparato. En el caso de que se produzcan averías en el aparato (por ej. desplazamiento difícil del émbolo, falta de hermeticidad), inmediatamente dejar de pipetear y seguir las instrucciones del capítulo '¿Qué hacer en caso de avería?' (véase pág. 148). En caso necesario dirigirse al fabricante.
11. No reemplazar el acumulador original por acumuladores no recargables o recargables de otros fabricantes.
12. Para cargar las baterías de níquel-metal hidruro, utilizar exclusivamente el equipo de red original.
13. Se debe utilizar el equipo de red únicamente con este aparato y protegerlo contra humedad.
14. Eliminar el acumulador sólo cuando está completamente descargado, y de acuerdo a las prescripciones en vigor.

### Advertencia:

La manipulación inadecuada del aparato o las baterías (cortocircuito, destrucción mecánica, sobrecalentamiento, un el equipo de red inadecuado, etc.) puede causar la explosión de las baterías en el caso más desfavorable.



La Transferpette®-8/-12 electronic es una pipeta multicanal de embolo controlada por microprocesador y que funciona con batería siguiendo el principio de cojín de aire para pipetear soluciones acuosas de viscosidad y densidad medias.

Si el aparato se maneja correctamente, la muestra que se desea dosificar sólo tendrá contacto con las puntas, y no con la Transferpette®-8/-12 electronic.

### Limitaciones de empleo

El aparato sirve para pipetear muestras teniendo en consideración las siguientes limitaciones:

- Temperatura de empleo de +15 °C a +40 °C (de 59 °F a 104 °F) (pueden obtenerse otras temperaturas si así se desea)
- presión de vapor de hasta 500 mbar
- viscosidad: 260 mPa s

### Limitaciones de uso

Los líquidos viscosos y humectantes pueden afectar a la exactitud del volumen. Al igual que los líquidos cuya temperatura difiera en más de  $\pm 5$  °C / 41 °F de la temperatura ambiente.

### Excepciones de uso

El usuario debe asegurarse de la compatibilidad del aparato para cada aplicación.

Nunca utilice el aparato para pipetear líquidos que puedan corroer polipropileno, fluoruro de polivinilideno y silicona (Vástago y puntas), policarbonato/polibutilenotereftalato (carcasa) o EPDM (vástagos de pipeta de recambio flexibles). Evite los vapores agresivos (peligro de corrosión).

La empuñadura no es autoclavable.

### Especificaciones de la batería y del equipo de red

#### Batería

Batería de níquel-metalhidruro con 3 pilas individuales cilíndricas del tamaño AAA, 3,6 V, 700 mAh

#### Equipo de red

Tensión de salida de 6,5 V CC, 200 mA

## Elementos de manejo

La Transferpette®-8/-12 electronic es una pipeta multicanal de embolo aspirante controlada por microprocesador y que funciona con batería que ha sido optimizada en cuanto a su ergonomía y facilitación de manejo.

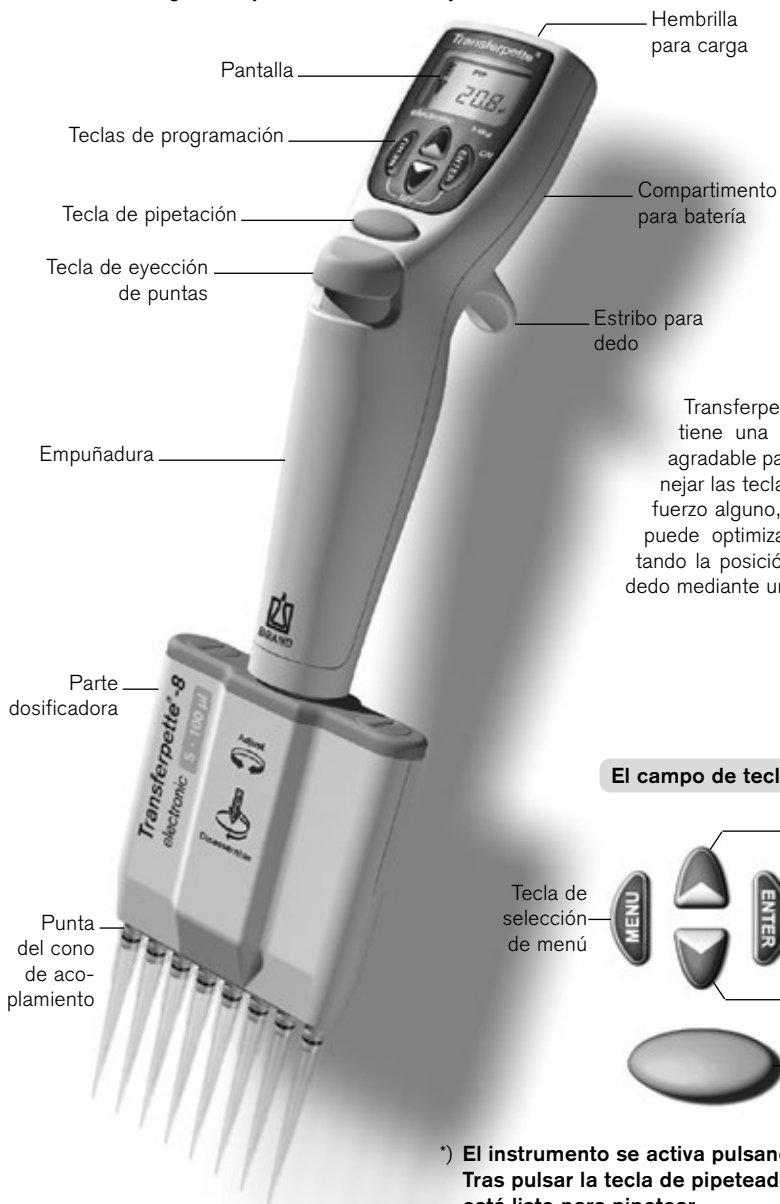

Transferpette®-8/-12 electronic tiene una forma ergonómica y agradable para la mano. Para manejar las teclas funcionales sin esfuerzo alguno, la posición de mano puede optimizarse aún más adaptando la posición del estribo para el dedo mediante un tornillo.

### El campo de teclas

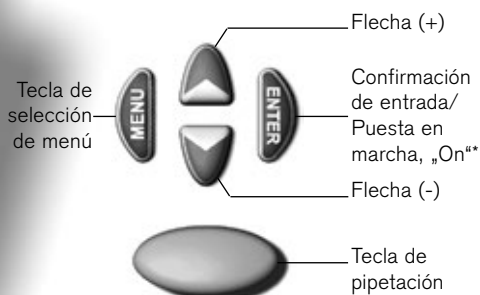

\*) El instrumento se activa pulsando la tecla Enter. Tras pulsar la tecla de pipeteado el instrumento está listo para pipetear.

Transferpette®-8/-12 electronic se apaga automáticamente al haber pasado 10 minutos desde el último uso (Auto-Power-Off).

## ¿La caja viene completa?

En la caja, deberá encontrar su Transferpette®-8 ó -12 electronic, una batería, el equipo de red con cable de carga de batería, 1 soporte para el aparato, 1 recipiente para reactivo, grasa de silicona, las presentes instrucciones de manejo, así como 1 juego de anillos-O de silicona.

### Puesta en marcha de Transferpette®-8/-12 electronic

#### 1. Colocar la batería

- a) Abra la tapa del compartimento de la batería.
- b) Inserte la batería. Tenga en cuenta que la clavija de la misma quede bien encajado en la hembra del aparato.
- c) Vuelva a colocar la tapa del compartimento de la batería y ciérrela bien.



#### 2. Activar el aparato

Transferpette®-8/-12 electronic solicita automáticamente un recorrido de referencia en cuanto se coloca la batería. Tras pulsar la tecla de pipeteado, se ejecuta el recorrido de referencia y el aparato estará listo para pipetear.



La pantalla muestra el modo de pipeteado estándar (PIP) ajustado en fábrica y el volumen nominal correspondiente (aquí, por ejemplo, 100,0 µl). La velocidad de aspiración y salida han sido ajustadas de fábrica con el valor máximo. El ajuste sencillo de volumen y velocidad se describe en las páginas siguientes.

Modo de pipeteado

Indicación de capacidad de la batería

Símbolo de flecha para 'Aspirar'

Indicación del volumen



## Ajuste de volumen

El volumen viene ajustado de fabrica al volumen nominal de Transferpette®-8/-12 electronic y puede modificarse individualmente de forma rápida y sencilla.

¿Qué tengo que hacer? ¿Cómo se hace?

¿Qué tecla?

¿Qué indica la pantalla?

### 1. Activar la selección de volumen

Pulsando una de las flechas, podrá seleccionar el volumen directamente. 'VOL' se encenderá intermitentemente.



### 2. Ajuste de volumen

#### Reducir

Pulsando la flecha (-) se reduce el volumen. Si mantiene pulsada la flecha, modificará el volumen con mayor rapidez. 'VOL' continuará encendiéndose intermitentemente.

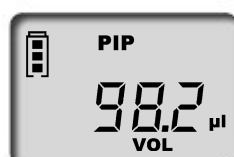

#### Aumentar

Pulsando la flecha (+) se aumenta el volumen. Si mantiene pulsada la flecha, modificará el volumen con mayor rapidez. 'VOL' continuará encendiéndose intermitentemente.



### 3. Confirmar la selección de volumen

Pulsar la tecla Enter. Entonces, la pantalla mostrará el nuevo volumen ajustado. Como ejemplo, aquí le mostramos la pantalla del modo PIP ajustado como en serie.

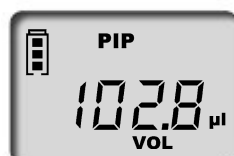

#### Importante:

Pulsando la tecla de menú, podrá cancelar todos los procesos de ajuste. Entonces, la pantalla pasará a la opción de ajuste más cercana o volverá a la indicación inicial.

## Ajuste de la velocidad de aspiración y salida

Las velocidades de aspiración y salida pueden ajustarse de forma individual. Al llamar el menú, se mostrará la última velocidad ajustada correspondientemente. Existen 5 niveles de velocidad ajustables correspondientemente.

¿Qué tengo que hacer? ¿Cómo se hace?

¿Qué tecla?

¿Qué indica la pantalla?

### Ajustar la velocidad de aspiración

#### 1. Llamar el menú

Pulsando una vez y brevemente la tecla de menú, se llega al menú de velocidad de aspiración. La palabra **,Speed'** se iluminará intermitentemente.

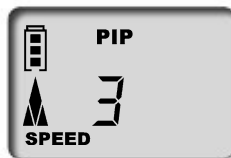

#### 2. Ajustar la velocidad de aspiración

Pulsando las flechas (+/-) se selecciona el nivel de velocidad (por ejemplo, nivel 5). La palabra **,Speed'** continuará iluminándose intermitentemente.

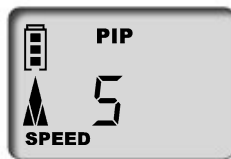

#### 3. Confirmar el nivel de velocidad

Pulsar la tecla Enter. La pantalla vuelve al estado básico del modo ajustado; aquí, como ejemplo, la pantalla del modo PIP estándar.



### Ajustar la velocidad de salida

#### 1. Llamar el menú

Pulsando dos veces y brevemente la tecla de menú, se llega al menú de velocidad de salida. La palabra **,Speed'** se iluminará intermitentemente.

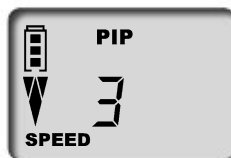

#### 2. Ajustar la velocidad de salida

Pulsando las flechas (+/-) se selecciona el nivel de velocidad (por ejemplo, nivel 2). La palabra **,Speed'** continuará iluminándose intermitentemente.

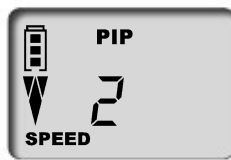

#### 3. Confirmar el nivel de velocidad

Pulsar la tecla Enter. Entonces, la pantalla vuelve al estado básico del modo ajustado; aquí, como ejemplo, la pantalla del modo PIP estándar.



El volumen viene ajustado de fábrica al volumen nominal de Transferpette®-8/-12 electronic y puede modificarse individualmente de forma rápida y sencilla (véase la página 122).

### Inicio rápido (Quick Start) en el modo de pipeteado estándar

#### 1. Acoplar las puntas

Utilizar las puntas apropiadas, de acuerdo con el rango de volumen y el código de color. Verificar que el asiento de las puntas sea hermético y esté bien firme. Puntas de pipeta son artículos desechables!

#### 2. Alinear la parte dosificadora

La parte dosificadora gira libremente en ambos sentidos.

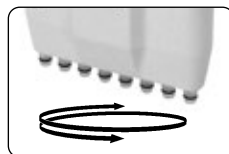

#### 3. Aspirar líquido

Mantenga el aparato en posición vertical y sumerja las puntas 2-3 mm en el líquido.



Pulsando la tecla de pipeteado, el líquido se aspirará. La flecha de la pantalla indica hacia arriba (aspiración).



1x

**Nota:** Para que no se aspire aire, mantenga sumergidas las puntas durante aprox. 1 seg. más.

#### 4. Expulsar líquido

Una vez finalizada la absorción de líquido, la flecha de la pantalla indicará hacia abajo (salida).

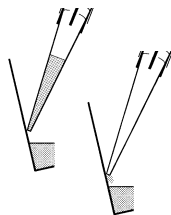

Apoye las puntas de la pipeta en la pared del recipiente. Mantenga la pipeta en un ángulo de 30-45°.

Pulsando nuevamente la tecla de pipeteado, el líquido se soltará completamente con la carrera excesiva automática. Al hacerlo, escurra las puntas de la pipeta en la pared del recipiente.

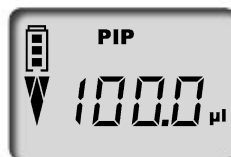

1x

#### 5. Expulsar las puntas

Mantenga la parte dosificadora sobre un recipiente de residuos adecuado y pulse hacia abajo la tecla de eyección de puntas.

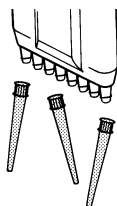

Tecla de eyección de la punta



**Nota:**

La norma ISO 8655 prescribe que las puntas, antes del proceso de pipeteado propiamente dicho, deben enjuagarse con el líquido de la muestra.

- 1. Pipeteado normal**  
Modo **PIP** \_\_\_\_\_ **126**  
Programa estándar.  
Se aspira un volumen ajustado previamente y se vuelve a soltar.
  
- 2. Mezclar muestras**  
Modo **PIPMix** \_\_\_\_\_ **128**  
Programa para mezclar líquidos. La muestra se aspira y suelta repetidamente en todo momento.
  
- 3. Pipeteado inverso**  
Modo **revPIP** \_\_\_\_\_ **130**  
Programa especial para pipetear líquidos de alta viscosidad, alta presión de vapor o medios espumosos.
  
- 4. Pipetear en electroforesis**  
Modo **GEL** \_\_\_\_\_ **132**  
Programa para cargar geles en electroforesis. Un volumen de muestra previamente definido se aspira a gran velocidad modificable y se vuelve a soltar lentamente.
  
- 5. Dosificación**  
Modo **DISP** \_\_\_\_\_ **134**  
Programa para la dosificación de líquidos. Un volumen aspirado es dosificado en pasos parciales.

El programa estándar:

se aspira un volumen ajustado previamente y se vuelve a soltar.

El ajuste de volumen y velocidad como se ha descrito en la página 122/123.

¿Qué tengo que hacer? ¿Cómo se hace?

¿Qué tecla?

¿Qué indica la pantalla?

## 1. Llamar la selección de menú

Pulsando la tecla de menú tres veces, se llega a la selección de programa. 'Mode' se iluminará intermitentemente.

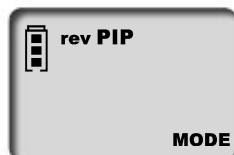

## 2. Ajustar el modo PIP

Con una de las flechas, desplácese por los diferentes modos hasta que aparezca 'PIP'. 'Mode' continuará iluminándose intermitentemente.

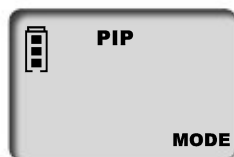

## 3. Confirmar el modo PIP

Pulsar la tecla Enter. En la pantalla, podrá leer 'blo', que equivale a blow-out (carrera excesiva).

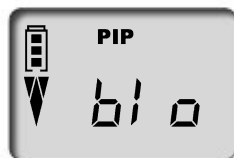

## 4. Preparación para pipetear

Pulsando la tecla de pipetación una vez, los émbolos se colocan en la posición de salida. La flecha de la pantalla indicará hacia arriba (aspiración).

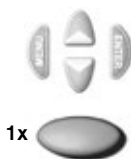

## 5. Absorber el líquido

Para aspirar el líquido, pulse una vez la tecla de pipeteado.

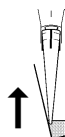



¿Qué tengo que hacer? ¿Cómo se hace?

¿Qué tecla?

¿Qué indica la pantalla?

## 6. Soltar líquido

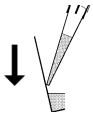

Pulsando una vez la tecla de pipeteado, se provocará la expulsión del líquido. La flecha de la pantalla indicará hacia abajo (salida).



## 7. ¿Activar la carrera excesiva?

**¡Usted no tiene que hacer nada!** Al pipetear en el modo PIP, **¡la carrera excesiva (blow-out) se activa automáticamente!**



## Activación directa del blow-out

La carrera excesiva (blow-out) también puede activarse directamente en todo momento, siempre que sea necesario.

### 1. Llamar la función blow-out

Pulsar la tecla Enter. En la pantalla, podrá leer 'blo', que equivale a blow-out.

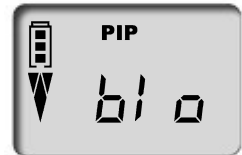

### 2. Activar la carrera excesiva

Pulsando una vez la tecla de pipeteado, se activa la carrera excesiva y la pantalla vuelve a mostrar el modo de pipeteado ajustado (posición de salida).

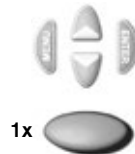

### Nota:

En el modo de carrera excesiva (blow-out), los émbolos se mueven completamente hacia abajo. Deberá asegurarse de que el posible líquido sobrante se suelte sin provocar peligros.

**Mantener la tecla de pipetación apretada mantiene los émbolos abajo, por lo que evita que se produzca una aspiración no deseada de líquido. Soltarla provocará que los émbolos vuelvan a la posición de salida.**

Programa para mezclar líquidos.

La muestra se aspira y suelta repetidamente en todo momento.

El ajuste de volumen y velocidad como se ha descrito en la página 122/123.

¿Qué tengo que hacer?    ¿Cómo se hace?    ¿Qué tecla?    ¿Qué indica la pantalla?

## 1. Llamar la selección de menú

Pulsando la tecla de menú tres veces, se llega a la selección de programa. 'Mode' se iluminará intermitentemente.

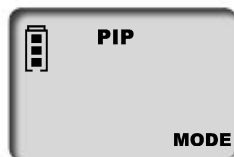

## 2. Ajustar el modo PIPmix

Con una de las flechas, desplácese por los diferentes modos hasta que aparezca 'PIPmix'. 'Mode' continuará iluminándose intermitentemente.



## 3. Confirmar el modo PIPmix

Pulsar la tecla Enter. En la pantalla, podrá leer 'blo', que equivale a blow-out (carrera excesiva).



## 4. Preparación para pipetear

Pulsando la tecla de pipeteado una vez, los émbolos se colocan en la posición de salida. La flecha de la pantalla indicará hacia arriba (aspiración).

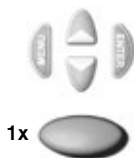

## 5. Aspirar el líquido

Para aspirar el líquido, pulse una vez la tecla de pipeteado.

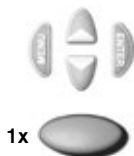
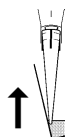

¿Qué tengo que hacer? ¿Cómo se hace?

¿Qué tecla?

¿Qué indica la pantalla?

**6. Soltar líquido en el modo PIPmix**

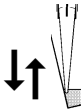

Manteniendo pulsada la tecla de pipeteado, se provocará la salida y aspiración alterna del líquido. En la pantalla aparecerán alternados los iconos de las flechas de absorción o salida, así como el número de ciclos.



**7. Finalizar el pipeteado**





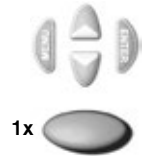









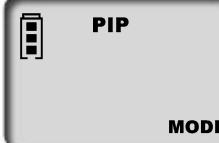















Pulsando una vez la tecla de pipeteado, se suelta el líquido y se activa la carrera excesiva (el blow-out).

Una vez soltado el líquido restante (carrera excesiva), la pantalla volverá a ponerse en el modo ajustado (posición de salida).



**Nota:** La pantalla muestra un máximo de 19 ciclos.

Programa especial para pipetear líquidos de alta viscosidad, presión de vapor o medios espumosos. El ajuste de volumen y velocidad, véase la descripción de la página 122/123.

¿Qué tengo que hacer?	¿Cómo se hace?	¿Qué tecla?	¿Qué indica la pantalla?
<b>1. Llamar la selección de menú</b>	Pulsando la tecla de menú tres veces, se llega a la selección de programa. 'Mode' se iluminará intermitentemente.	3x     	
<b>2. Ajustar el modo revPIP</b>	Con una de las flechas, desplácese por los diferentes modos hasta que aparezca 'revPIP'. 'Mode' continuará iluminándose intermitentemente.	   	
<b>3. Confirmar el modo revPIP</b>	Pulsar la tecla Enter. En la pantalla, podrá leer 'blo', que equivale a blow-out (carrera excesiva).	   1x 	
<b>4. Preparación para pipetear</b>	Pulsando la tecla de pipeteado una vez, los émbolos se colocan en la posición de salida. La flecha de la pantalla indicará hacia arriba (aspiración).	   1x 	
<b>5. Absorber el líquido</b>	Pulsar la tecla de pipeteado una vez: ¡se aspirará un volumen algo superior al ajustado!	   1x 	
<b>6. Soltar líquido en el modo revPIP</b>	Para soltar líquido, pulse la tecla de pipeteado una vez. La pantalla mostrará la flecha hacia abajo (salida). Entonces, se soltará el volumen ajustado y quedará algo de líquido en las puntas.	   1x 	

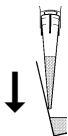
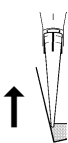

¿Qué tengo que hacer? ¿Cómo se hace?      ¿Qué tecla?      ¿Qué indica la pantalla?

**7. Volver a aspirar líquido en el modo revPIP**

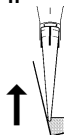

Pulsando nuevamente la tecla de pipeteado, se volverá a aspirar el volumen ajustado. (Pulsando nuevamente la tecla de pipeteado, se vuelve a soltar el volumen, etc.)



**8. Activar la carrera excesiva**

Tras el último pipeteado, pulsar la tecla Enter. En la pantalla, podrá leer 'blo', que equivale a blow-out (carrera excesiva).

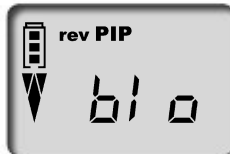

Pulsando una vez la tecla de pipeteado, se activa la carrera excesiva (el blow-out) y se suelta el líquido restante.

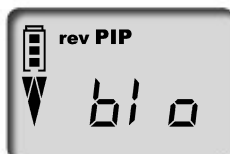
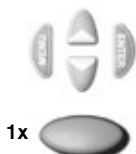









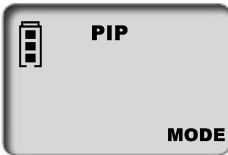

**9. Finalizar el pipeteado**

Una vez soltado el líquido restante (carrera excesiva), la pantalla volverá a ponerse en el modo ajustado (posición de salida).

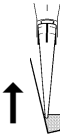

Programa para cargar geles en electroforesis. Un volumen de muestra previamente definido se absorbe a gran velocidad modificable y se vuelve a soltar lentamente. El ajuste de volumen y velocidad como se ha descrito en la página 122/123.

¿Qué tengo que hacer? ¿Cómo se hace?	¿Qué tecla?	¿Qué indica la pantalla?
<p><b>1. Llamar la selección de menú</b></p>	<p>Pulsando la tecla de menú tres veces, se llega a la selección de programa. <b>'Mode'</b> se iluminará intermitentemente.</p>	<p>3x  </p>
<p><b>2. Ajustar el modo GEL</b></p>	<p>Con una de las flechas, desplácese por los diferentes modos hasta que aparezca <b>'GEL'</b>. <b>'Mode'</b> continuará iluminándose intermitentemente.</p>	<p> </p>
<p><b>3. Confirmar el modo GEL</b></p>	<p>Pulsar la tecla Enter. En la pantalla, podrá leer <b>'blo'</b>, que equivale a blow-out (carrera excesiva).</p>	<p> 1x </p>
<p><b>4. Preparación para pipetear</b></p>	<p>Pulsando la tecla de pipeteado una vez, los émbolos se colocan en la posición de salida. La flecha de la pantalla indicará hacia arriba (aspiración).</p>	<p> 1x </p>
<p><b>5. Aspirar líquido</b></p> 	<p>Para aspirar el líquido, pulse una vez la tecla de pipeteado. El volumen ajustado se aspira.</p>	<p> 1x </p>
<p><b>Aspirar un mayor volumen</b></p> <p>Para aspirar más líquido que el ajustado (hasta un máximo del 110% del volumen nominal), mantenga la tecla de pipeteado durante el proceso de aspiración hasta que se haya aspirado el volumen deseado. En la pantalla, aparecerá un rombo.</p>	<p> <b>mantener pulsada</b></p>	<p></p>

¿Qué tengo que hacer? ¿Cómo se hace?      ¿Qué tecla?      ¿Qué indica la pantalla?

## 6. Soltar líquido en el modo GEL

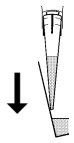

Para soltar líquido, pulse brevemente la tecla de pipeteado una vez. En la pantalla, aparecerá un rombo. El volumen aspirado se irá soltando lentamente.

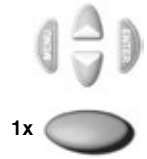

### Detener la salida

La salida de muestra puede detenerse pulsando nuevamente la tecla de pipeteado. La pantalla mostrará el volumen de la cantidad de líquido soltada.

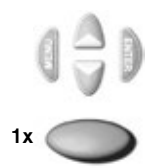

## 7. Activar la carrera excesiva

Tras el último pipeteado, pulsar la tecla Enter. En la pantalla, podrá leer 'blo', que equivale a blow-out (carrera excesiva).



Pulsando una vez la tecla de pipeteado, se activa la carrera excesiva (el blow-out) y se suelta el líquido restante.

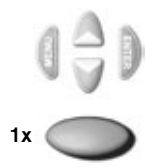

## 8. Finalizar el pipeteado









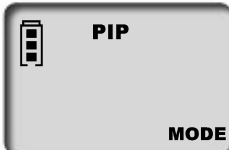

Una vez soltado el líquido restante (carrera excesiva), la pantalla volverá a ponerse en el modo ajustado (posición de salida).

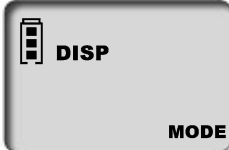

### Nota:

El modo GEL exige velocidades de salida muy lentas para evitar que se produzcan fluidizaciones en las muestras. Para que quede garantizada la salida óptima, la velocidad de salida viene fijada de fábrica. Es claramente más lenta que el nivel 1 ajustable, y no puede ser seleccionada individualmente.

Programa para la dosificación de líquidos. Un volumen aspirado es dosificado en pasos parciales. Se aspira un poco más volumen que calculadamente necesario. El ajuste de la velocidad como se ha descrito en la página 123.

¿Qué tengo que hacer? ¿Cómo se hace?	¿Qué tecla?	¿Qué indica la pantalla?
<p>1. Llamar la selección de menú</p>	<p>Pulsando la tecla de menú tres veces, se llega a la selección de programa. 'Mode' se iluminará intermitentemente.</p>	<p>3x  </p>
<p>2. Ajustar el modo DISP</p>	<p>Con una de las flechas, desplácese por los diferentes modos hasta que aparezca 'DISP'. 'Mode' continuará iluminándose intermitentemente.</p>	<p> </p>
<p>3. Confirmar el modo DISP</p>	<p>Pulsar la tecla Enter. En la pantalla, podrá leer 'blo', que equivale a blow-out (carrera excesiva).</p>	<p> 1x </p>
<p>4. Preparación para dosificar</p>	<p>Pulsando la tecla de pipeteado una vez, los émbolos se colocan en la posición de salida. La flecha de la pantalla indicará hacia arriba (absorción).</p>	<p> 1x </p>
<p>5. Ajustar el volumen parcial</p>	<p>Pulsando la flecha (+/-) se ajustará el volumen. Si mantiene pulsada la flecha, modificará el volumen con mayor rapidez. 'VOL' se iluminará intermitentemente.</p>	<p> </p>
<p>6. Confirmar el volumen parcial</p>	<p>Pulsar la tecla Enter. La pantalla mostrará el nuevo volumen parcial ajustado. 'steps' se iluminará intermitentemente. El display enseña el número máximo posible de pasos.</p>	<p> 1x </p>



¿Qué tengo que hacer? ¿Cómo se hace?

¿Qué tecla?

¿Qué indica la pantalla?

**7. Ajustar el número de pasos**

Pulsando la flecha (+/-) se ajusta el número de pasos. 'steps' continuará encendiéndose intermitentemente.

**8. Confirmar el número de pasos**

Pulsar la tecla Enter. Entonces, la pantalla mostrará el número de pasos seleccionado.

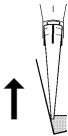
**9. Absorber el líquido**

Para absorber el líquido, pulse una vez la tecla de pipeteado.

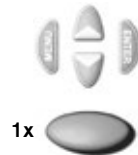
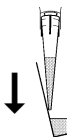
**10. Soltar el líquido**

Con cada pulsación de la tecla de pipeteado se efectúa un paso de dosificación. La flecha de la pantalla indicará hacia abajo (salida). La pantalla mostrará el número de pasos restantes.

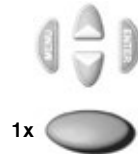
**11. Activar la carrera excesiva**

Tras la última dosificación pulsar la tecla Enter. En la pantalla, podrá leer 'blo', (carrera excesiva). Pulsando de la tecla pipeteado tras activará la carrera excesiva (blow-out) (véase pág 133).

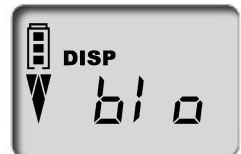
**12. Finalizar la dosificación**

Una vez soltado el líquido restante (carrera excesiva), la pantalla volverá a ponerse en el modo ajustado (posición de salida).



# Controlar el volumen

Recomendamos, dependiendo del uso, que el aparato pase por un control cada 3-12 meses. No obstante, el ciclo puede adaptarse a sus necesidades individuales.

La comprobación de volumen gravimétrica de la pipeta se realiza en pasos subsiguientes y cumple con la norma DIN EN ISO 8655, parte 6.

## 1. Ajustar el volumen nominal

Ajuste el volumen al máximo volumen indicado en el instrumento. Para informarse sobre el modo de proceder, véase la página 122.

## 2. Condicionar la pipeta

Condicionar la pipeta antes de realizar la comprobación, aspirando y sacando el líquido de comprobación ( $H_2O$  dest.) cinco veces con las puntas de pipetear. Después, desechar las puntas de pipetear.

## 3. Realizar la comprobación

- Acople nuevas puntas de pipetear y enjuague una vez con el líquido de comprobación.
- Aspire el líquido de comprobación y pipetéelo en el recipiente de pesar.

**Nota:** Cada uno de los canales deberá comprobarse por separado.

- Pese la cantidad pipeteada con una balanza de análisis. (Siga las instrucciones de manejo del fabricante de la balanza).
- Calcule el volumen pipeteado. A la hora de hacerlo, tenga en cuenta la temperatura.
- Se recomienda hacer 3-10 pipeteados y pesarlos por canal en 3 márgenes de volumen (100%, 50%, 10%).

### Cálculo (para el volumen nominal)

$x_i$  = resultados de las pesadas  
 $n$  = número de pesadas

$Z$  = factor de corrección  
(por ej. 1,0029  $\mu\text{l}/\text{mg}$  a una temperatura de 20 °C, 1013 hPa)

Valor medio  $\bar{x} = \frac{\sum x_i}{n}$

Volumen medio  $\bar{V} = \bar{x} \cdot Z$

#### Exactitud\*

$$E\% = \frac{\bar{V} - V_0}{V_0} \cdot 100$$

$V_0$  = volumen nominal

#### Desviación standard

$$s = Z \cdot \sqrt{\frac{\sum (x_i - \bar{x})^2}{n - 1}}$$

#### Coefficiente de variación\*

$$CV\% = \frac{100 \cdot s}{\bar{V}}$$

\*) = Cálculo de la exactitud (E%) y el coeficiente de variación (CV%):  
E% y CV% se calculan según las fórmulas de control estadístico de calidad.

Los valores finales de comprobación referentes al volumen nominal impreso en el aparato (= vol. máximo) y a los volúmenes parciales indicados a la misma temperatura (20 °C) del aparato, entorno y agua dest. según la norma DIN EN ISO 8655.

CE



20 °C  
Ex

## Valores de precisión de Transferpette®-8/-12 electronic

Gama de ajuste µl	Volumen parcial µl	E* ≤ ± %	CV* ≤ %	Pasos parciales µl	Tipo de punta rec., µl
0,5 - 10	10	1,2	0,8	0,01	0,5 - 20
	5	2,0	1,5		
	1	8,0	4,0		
1 - 20	20	1,0	0,5	0,02	0,5 - 20
	10	2,0	1,0		
	2	8,0	3,0		
5 - 100	100	0,8	0,25	0,1	2 - 200
	50	1,6	0,4		
	10	4,0	1,5		
10 - 200	200	0,8	0,25	0,2	2 - 200
	100	1,4	0,4		
	20	4,0	1,3		
15 - 300	300	0,6	0,25	0,5	5 - 300
	150	1,2	0,4		
	30	3,0	1,2		

\* E = Exactitud, CV = Coeficiente de variación

### Nota:

Bajo [www.brand.de](http://www.brand.de) se encuentran instrucciones de ensayo disponibles, como así también una versión del programa de calibración EASYCAL™ 4.0.

## El modo de ajuste 'CAL'

### Ajustar

El volumen nominal o el volumen que debe comprobarse está ajustado, modo estándar de pipetear (PIP), por ejemplo 100,0 µl (Modo de proceder, véase la página 122, 126).

P.e.: volumen correspondiente de la comprobación de volumen 101,3 µl.



¿Qué tengo que hacer?    ¿Cómo se hace?    ¿Qué tecla?    ¿Qué indica la pantalla?

### 1. Llamar el modo CAL

Manteniendo pulsada (>3 seg.) la tecla de menú, se llama el modo CAL. En la pantalla, aparecerá 'off'. 'CAL' se iluminará intermitentemente.

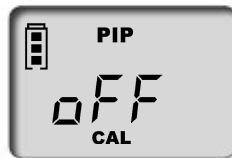

### 2. Activar el modo CAL

Pulsando una de las flechas, se activa el modo CAL. En la pantalla, se pasará de 'off' a 'on'. 'CAL' continuará encendiéndose intermitentemente.

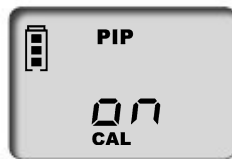

### 3. Confirmar el modo CAL

Pulsar la tecla Enter. En la pantalla podrá volver a leer el volumen de pipeteado ajustado. 'CAL' se iluminará intermitentemente.

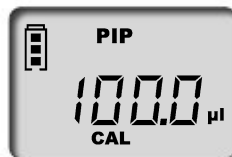

### 4. Ajuste de volumen

Con las flechas (+/-), ajuste el volumen determinado y comprobado anteriormente. 'CAL' se iluminará intermitentemente.



### 5. Confirmar el volumen

Pulsar la tecla Enter. En la pantalla aparecerá el volumen comprobado y corregido. El símbolo CAL que entonces aparecerá constantemente es prueba del ajuste realizado.



**Volver a obtener el estado original de fábrica**

El símbolo CAL que aparece constantemente en la pantalla es muestra de que se ha realizado un ajuste.



**¿Qué tengo que hacer? ¿Cómo se hace?      ¿Qué tecla?      ¿Qué indica la pantalla?**

**1. Llamar el modo CAL**

Manteniendo pulsada (>3 seg.) la tecla de menú, se llama el modo CAL. En la pantalla, aparecerá 'on'. 'CAL' se iluminará intermitentemente.

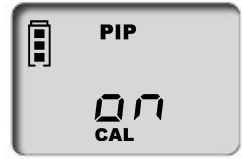

**2. Desactivar el modo CAL**

Pulsando una de las flechas, se desactiva el modo CAL. En la pantalla, se pasará de 'on' a 'off'. 'CAL' continuará encendiéndose intermitentemente.

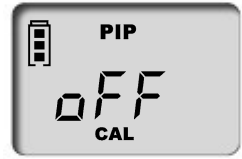

**3. Volver a activar el estado original de fábrica**

Pulsar la tecla Enter. El icono CAL que aparecía constantemente ha desaparecido. El aparato vuelve a estar en el estado original de fábrica.



**Importante:** En Transferpette®-8/-12 electronic, al realizar un ajuste se realiza un offset del volumen, es decir, el volumen se modifica en todo el margen de volumen de la pipeta con la misma cantidad. Se recomienda realizar el ajuste a un 50% del volumen nominal.

**Nota:** El aparato está ajustado permanentemente para soluciones acuosas, aunque también puede ajustarse para soluciones de diversos espesores, diversas viscosidades y diversas temperaturas. Transferpette®-8/-12 electronic puede ser ajustado en todos los modos (excepto el modo GEL).

## Autoclavage

La parte dosificadora (P) ilustrada de la Transferpette®-8/-12 electronic es autoclavable a 121 °C (2 bares) y con un tiempo de detención de como mínimo 15 minutos según la norma DIN EN 285.

**Atención:** ¡La empuñadura no es autoclavable!

1. Eyectar las puntas de la pipeta.
2. Destornillar la parte de dosificadora de la empuñadura (véase pagina 142).
3. Sin desmontarlo adicionalmente, autoclavar la parte de dosificadora completo.
4. Dejar que la parte de dosificadora se enfríe y seque completamente.
5. Atornillar otra vez la parte de dosificadora en la empuñadura (véase pagina 142).
6. Realizar el recorrido de referencia (rEF).

**Nota:** La eficacia de la autoclavización deberá ser comprobada por el propio usuario.  
La esterilización al vacío proporciona la máxima seguridad.  
Recomendamos el uso de bolsas de esterilización.

En caso de que se autoclave la parte de dosificadora con frecuencia, los émbolos deberán lubricarse con la grasa de silicona adjunto.

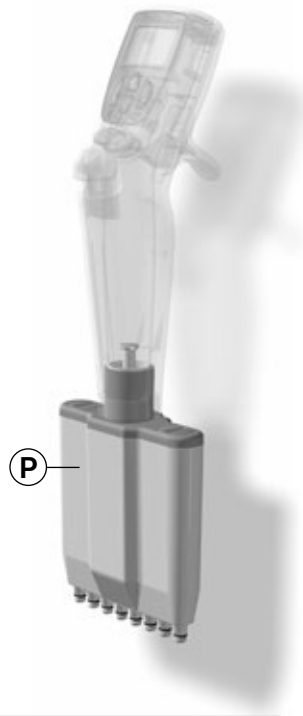

## Recorrido de referencia (rEF)

Cada vez que sustituya la parte de dosificadora deberá realizar un recorrido de referencia manual. El recorrido de referencia sirve para acoplar el émbolo de forma segura.

¿Qué tengo que hacer? ¿Cómo se hace?

¿Qué tecla?

¿Qué indica la pantalla?

1. Llamar el modo rEF

Apretando simultáneamente las teclas de menú y Enter se activa el modo rEF.

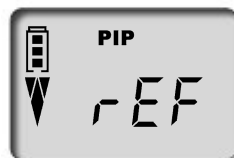

2. Ejecutar el recorrido de referencia

Apretando una vez la tecla de pipetación se inicia el recorrido de referencia. Podrá escuchar un sonido claro debido al funcionamiento.

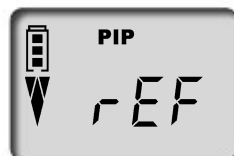
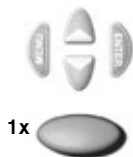

**Nota:** Una vez realizado el recorrido de referencia, la pantalla vuelve a pasar automáticamente al programa que estaba ajustado anteriormente.

Para realizar el mantenimiento, la limpieza o para recambiar piezas, los tres componentes principales de la parte dosificadora pueden separarse y desmontarse fácilmente. El modo de proceder se explica detalladamente en las siguientes páginas.

**Nota:** En las instrucciones adjuntas en la pieza de repuesto se describe minuciosamente cómo sustituir los anillos-V/anillos-O.

## Los componentes principales de la parte dosificadora

- A Unidad de émbolos** con soporte con cojinetes de émbolo [ I ] y los émbolos insertados en ella que pueden desatornillarse individualmente para su limpieza o sustitución
- B Grupo de vástagos** con soporte con cojinetes de vástago [ II ] y el eje guía central (Z) fijado al mismo que pueden desatornillarse individualmente para su limpieza o sustitución
- C Carcasa** que se une a la tapa carcasa [ III ] con dos cierres de bayoneta

## Mantenimiento

Para garantizar el funcionamiento correcto de la Transferpette® -8/-12 electronic, deberán realizarse trabajos de mantenimiento y limpieza regularmente.

### ¿Qué debe comprobarse?

1. Compruebe que los vástagos, los émbolos y las juntas no están dañados ni sucios.
2. Compruebe la hermeticidad del aparato. Recomendamos usar el aparato verificador de estanqueidad de BRAND PLT unit. Alternativo: para ello, aspire una muestra y mantenga el aparato en posición vertical durante unos 10 segundos. En caso de que en las puntas de la pipeta se forme una gota: consulte el apartado „¿Qué hacer en caso de avería?“ pág. 148.

### Indicaciones para la limpieza (página 142-145)

1. Limpiar los vástagos individuales, los émbolos y el soporte con cojinetes de émbolo (**sólo estas piezas**) con solución jabonosa o isopropanol, enjuagar a continuación con agua destilada.
2. Dejar que las piezas se sequen y enfríen completamente. Los restos de líquido en los vástagos conducen a desviaciones de la exactitud.
3. Engrasar ligeramente los émbolos con la grasa de silicona suministrado con el aparato. Para lubricar el eje guía central (Z) utilizar exclusivamente la grasa fluorada prescrita.
4. Tras montar el aparato, realizar un recorrido de referencia (rEF).

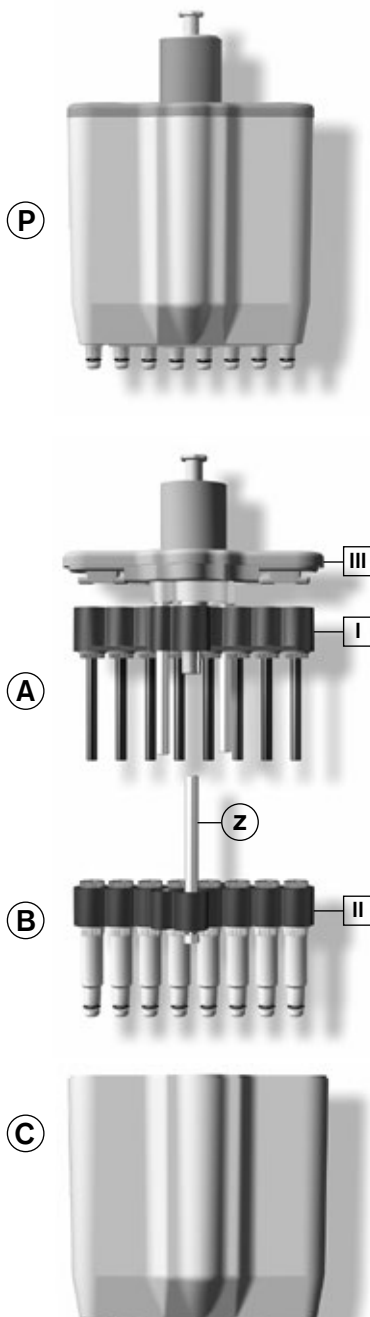

## Mantenimiento y limpieza

### Separación empuñadura – parte dosificadora

1. Expulsar las puntas de pipetas.
2. Para desacoplar, primero tirar la parte dosificadora todo lo posible hacia abajo, **y después** girarla en sentido de las agujas del reloj. Después de realizado un giro, no es necesario tirar hacia abajo.
3. Otra vez tirar la parte dosificadora desenroscada hacia abajo para separar el imán.

#### Nota:

Enroscar la parte dosificadora en sentido inverso a las agujas del reloj sobre la empuñadura, hasta que encaje de forma audible.

No tirar la parte dosificadora hacia abajo durante el montaje.

#### Atención:

Una manipulación equivocada puede provocar daños al aparato.



### Retirar vástagos y juntas para su limpieza o sustitución

1. **Desenroscar la parte dosificadora** Desenroscar la parte dosificadora de la empuñadura.

2. **Retirar carcasa** Girar los dos cierres de bayoneta de la tapa carcasa a 90°. Retirar la carcasa.

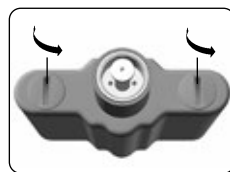

3. **Extraer el vástago** Colocar la llave de montaje sobre el vástago individual y desatornillar y extraer el vástago

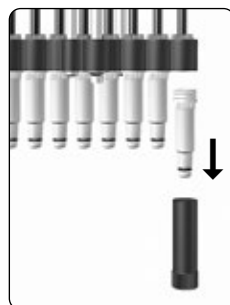



## 4. Retirar la junta

Desplazar la unidad de émbolos completamente hacia abajo. Retirar la junta y comprobarla. En caso necesario, limpiarla o sustituirla

**Nota:**

Tras retirar el vástago, la junta se encontrará bien en el vástago o sobre el émbolo.

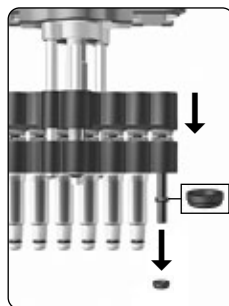

## 5. Introducir la junta

En caso necesario, engrasar ligeramente el émbolo con la grasa de silicona suministrado con el aparato. Introducir la junta con la parte aplanada hacia arriba. Atornillar el vástago limpiado o nuevo fijamente con la llave de montaje.

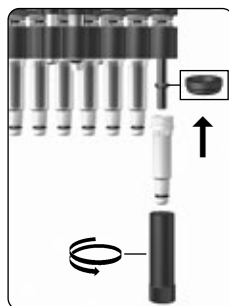

## 6. Montar la parte dosificadora

Montar otra vez la parte dosificadora y ajustar a la empuñadura.

**Nota:**

Enroscar la parte dosificadora en sentido inverso a las agujas del reloj sobre la empuñadura, hasta que encaje de forma audible.

No tirar la parte dosificadora hacia abajo.

Comprobar la hermeticidad, suavidad y precisión del aparato (véase pág. 141 „Mantenimiento“).

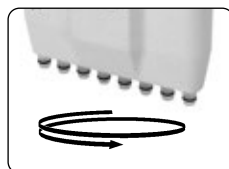

## 7. Ejecutar el recorrido de referencia

Ejecutar el recorrido de referencia (rEF).

## Retirar el émbolo para su limpieza o sustitución

1. **Desenroscar la parte dosificadora**      Desenroscar la parte dosificadora de la empuñadura (Véase p. 140).

2. **Retirar carcasa**      Girar los dos cierres de bayoneta de la tapa carcasa a 90°. Retirar la carcasa.

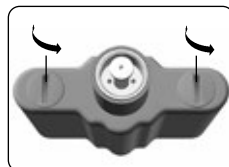

3. **Eliminar los tornillos**      Eliminar los dos tornillos exteriores con ranura en cruz.

**Atención:**

¡No soltar el eje guía central (Z)!

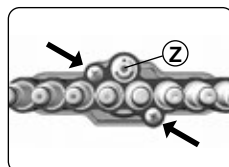

4. **Separar la unidad de émbolos y el grupo de vástagos**      Tirar separando la unidad de émbolos y el grupo de vástagos

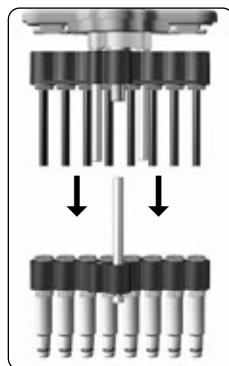

5. **Retirar el émbolo**      Insertar la llave de montaje sobre la tuerca del émbolo y desatornillarla. Retirar la tuerca de émbolos y sacar el émbolo.

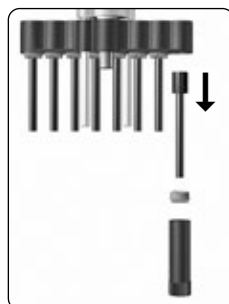

## 6. Montar el émbolo

Colocar el émbolo limpiado o nuevo y volver a atornillar fijamente la tuerca del émbolo con la llave de montaje

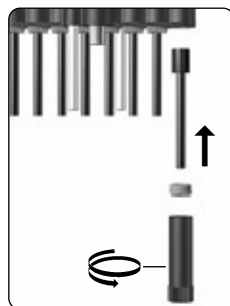

## 7. Montar la unidad de émbolos y el grupo de vástagos

Soltar los vástagos con una media rotación. Colocar a continuación el grupo de vástagos sobre la unidad de émbolos y fijarse. Después enroscar los vástagos.

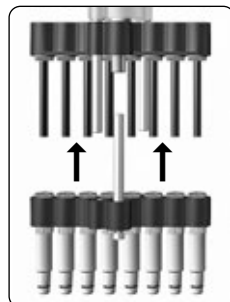

## 8. Montar la parte dosificadora

Montar otra vez la parte dosificadora y ajustar a la empuñadura.

### Nota:

Enroscar la parte dosificadora en sentido inverso a las agujas del reloj sobre la empuñadura, hasta que encaje de forma audible.

No tirar la parte dosificadora hacia abajo.

Comprobar la hermeticidad, suavidad y precisión del aparato (véase pág. 141 „Mantenimiento“).

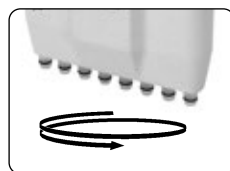

## 9. Ejecutar el recorrido de referencia

Ejecutar el recorrido de referencia (rEF).

## Cargar y cambiar la batería

Una batería cargada completamente permite pipetear muestras de viscosidad y densidad similar al agua de forma continua durante unas 8 horas.

### Atención:

Antes de cargar la batería, deberá asegurarse de que el equipo de red es adecuado para el voltaje existente en el laboratorio. El aparato no deberá ser cargado en un entorno potencialmente explosivo. ¡La batería sólo podrá ser cargada en la Transferpette®-8/-12 electronic!

### Recargar la batería

- Meta la clavija del cable de carga del equipo de red en la hembra de la Transferpette®-8/-12 electronic. El proceso de carga se iniciará automáticamente.
- Durante el proceso de carga, verá que los bloques de indicación de la capacidad de batería se mueven continuamente de abajo a arriba. La batería estará cargada completamente cuando los bloques de indicación ya no se muevan.



### ¿Es posible pipetear durante el proceso de carga?

Durante el proceso de carga de la batería, se puede seguir trabajando con la Transferpette®-8/-12 electronic. Si la batería está completamente descargada, tendrá que esperar unos minutos hasta que la batería se haya cargado con la capacidad mínima necesaria para trabajar con el aparato de forma segura.

**Nota:** Los ajustes que se han realizado la última vez se guardan en el EEPROM del aparato. En caso de que la batería se haya vaciado completamente o al sustituir la misma por otra, estos ajustes se mantendrán en la memoria.

### Sustituir la batería

- Abra la tapa del compartimento de la batería, saque la batería y desenchufe la clavija de la hembra.
- Meta la clavija de la nueva batería en la hembra y coloque la nueva batería en el aparato.
- Vuelva a colocar la tapa del compartimento de la batería y ciérrela bien.



En caso de que el aparato no vaya a ser utilizado durante mucho tiempo, extraiga la batería del mismo.

### Indicación del nivel de batería tras haber insertado una nueva batería

- a) Tras haber insertado una batería, en la pantalla aparecerá la **indicación de capacidad completa con un marco parpadeante** (el aparato no reconocerá el estado de carga de la batería en un primer momento). Tras un tiempo de carga de 3,5 h (el tiempo equivalente a la carga completa segura de la batería), el marco dejará de parpadear.



**Nota:**

¡Al insertar una batería, cárguela siempre durante 3,5 h! Después de algunos ciclos de carga/descarga se proporciona la capacidad de carga completa.

## Función de regeneración de batería

### (Función Refresh)

Para prolongar la vida útil y aumentar la potencia de las baterías, la Transferpette®-8/-12 electronic dispone de una función de regeneración (la función Refresh). Esta función permite descargar completamente y volver a cargar las baterías de forma controlada por el programa. Para optimizar la capacidad de potencia de las baterías, se recomienda aplicar la función Refresh de vez en cuando.

### Realizar función Refresh

- a) Meta la clavija (conexión) del equipo de red en la hembrilla de la parte superior de la Transferpette®-8/-12 electronic prevista para ello.



- b) Pulse la flecha inferior durante más de 3 segundos. Durante la descarga, los bloques indicadores de capacidad de la batería se mueven continuamente de arriba a abajo.



- c) Tras haberse finalizado la descarga (puede durar hasta 3 h), volverá a iniciarse el proceso de carga (de 3,5 h) automáticamente. Durante la carga, los bloques indicadores de capacidad de la batería se mueven continuamente de abajo a arriba.







### Cancelar la función Refresh

Al pulsar cualquier tecla, el programa se cancelará. El aparato pasará automáticamente al modo estándar de pipeteado (PIP) y volverá al volumen nominal; el proceso normal de carga se iniciará automáticamente (véase la página 146). Asimismo, el programa se cancelará al desenchufar la hembrilla del bloque de alimentación.

No cancelar la función Refresh al final del ciclo de descarga.

## ¿Qué hacer en caso de avería?

Al producirse una avería, en la pantalla podrá leer el aviso 'Err' y el número de error. Entonces, el aparato sólo reaccionará si pulsa la tecla Enter. Pulsando la tecla Enter se intenta iniciar de nuevo el aparato. Por tanto, automáticamente será necesario realizar un recorrido de referencia (rEF).

Avería	Aviso de fallo	Causa probable	¿Qué hacer?
El aparato no reacciona		La batería está vacía o averiada	Cargar batería al menos durante 5 min sin pulsar ninguna tecla; después, continuar trabajando sólo con cable de carga enchufado hasta que batería se haya recargado o sustituir la batería por otra
El aparato no reacciona		Módulos electrónicos defectuosos	Enviar el aparato a reparación
El aparato no reacciona		Error de programación imprevisto	Confirmación de error pulsando la tecla Enter. El aparato volverá a iniciarse
El aparato no reacciona		Módulos electrónicos defectuosos	Enviar el aparato a reparación
Pantalla en negro	—	Descarga eléctrica	Sacar y colocar de nuevo la batería
		Módulos electrónicos defectuosos	Enviar el aparato a reparación
La punta gotea/ El aparato no es hermético o hay un error de volumen	—	Punta no adecuada	Utilice sólo puntas de calidad
		La punta no está bien fijada	Inserte la punta de forma que quede fija
		Émbolo, vástago o obturación sucia o defectuosa	Limpie el aparato/ Sustituya la obturación Engrasarse el émbolo.
El líquido no es aspirado o se produce un fuerte ruido del motor	—	Marcha limitada del émbolo	Desatornillar la parte dosificadora y mover manualmente la pieza metálica central

## Símbolos informativos en el producto y la batería

Símbolos	Significado
	Por medio de este símbolo, constatamos que el producto cumple con los requisitos establecidos en las directivas de la CE y se ha sometido a los controles estipulados.
	El equipo cuenta con el símbolo que acredita el cumplimiento de la ley y los reglamentos de medición y calibrado de Alemania. El símbolo está compuesto por los caracteres DE-M (DE por Alemania) enmarcados en un rectángulo y los dos últimos dígitos del año en el que se ha acreditado el cumplimiento (en este caso, 2020).
XXZXXXXX	Número de serie
	Respetar las indicaciones contenidas en el equipo, los accesorios y las instrucciones de uso.
	El equipo y la batería deben desecharse adecuadamente.
	Siga las instrucciones de manejo.
	China RoHS (EFUP) El período de uso respetuoso con el medio ambiente (EFUP, por sus siglas en inglés) define el periodo de tiempo en años, dentro del cual las sustancias peligrosas contenidas en dispositivos eléctricos y electrónicos no se expulsarán ni mutarán mientras se mantengan las condiciones operativas normales. Siempre que el usuario lleve a cabo un uso normal, tales productos eléctricos y electrónicos no ocasionarán contaminaciones ambientales graves, lesiones graves o daños materiales al usuario.
	El equipo eléctrico no puede desecharse junto con los residuos domésticos.

### Transferpette®-8 electronic, con equipo de red incl. (100-240V/50-60 Hz)

volumen	0,5-10 µl	1-20 µl	5-100 µl	10-200 µl	15-300 µl
	ref.	ref.	ref.	ref.	ref.
para Europa (continental) (230V/50-60 Hz)	7053 99	7054 00	7054 03	7054 04	7054 06
para Reino Unido/Irlanda (230V/50-60 Hz)	7054 09	7054 10	7054 13	7054 14	7054 16
para EE.UU./Japón (110V/50-60 Hz)	7054 19	7054 20	7054 23	7054 24	7054 26
para Australia (240V/50-60 Hz)	7054 29	7054 30	7054 33	7054 34	7054 36

### Transferpette®-12 electronic, con equipo de red incl. (100-240V/50-60 Hz)

volumen	0,5-10 µl	1-20 µl	5-100 µl	10-200 µl	15-300 µl
	ref.	ref.	ref.	ref.	ref.
para Europa (continental) (230V/50-60 Hz)	7054 49	7054 50	7054 53	7054 54	7054 56
para Reino Unido/Irlanda (230V/50-60 Hz)	7054 59	7054 60	7054 63	7054 64	7054 66
para EE.UU./Japón (110V/50-60 Hz)	7054 69	7054 70	7054 73	7054 74	7054 76
para Australia (240V/50-60 Hz)	7054 79	7054 80	7054 83	7054 84	7054 86

### Equipo de red (100-240V/50-60 Hz)

descripción	ref.
para Europa (continental)	7053 50
para Reino Unido/Irlanda	7053 51
para EE.UU./Japón	7053 52
para Australia	7053 53



**Recambios para Transferpette®-8/-12 electronic**

El diseño y las dimensiones de las piezas de repuesto según el volumen nominal correspondiente. (Ilustr. piezas de recambio Transferpette® 8/-12 electronic 5-100 µl).

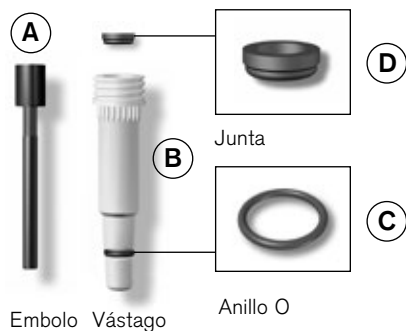

volumen	A	B*	C	D
0,5 - 10 µl	7056 59	7056 77	7033 80	7033 40
1 - 20 µl	7056 71	7056 78	7033 80	7033 41
5 - 100 µl	7056 62	7056 15	7056 18	7033 44
10 - 200 µl	7056 63	7056 16	7056 18	7033 45
15 - 300 µl	7056 64	7056 17	7056 18	7033 46

\* inclusive junta, anillo O y llave de montaje

**Puntas de pipeta de BRAND,**  
paletizadas, en TipBox

volumen	cantidad de puntas	ref.
0,1 - 20 µl	480	7322 02
0,5 - 20 µl	480	7322 04
2 - 200 µl	480	7322 08
5 - 300 µl	480	7322 10

**Accesorios adicionales**

descripción	ref.
Batería de repuesto	7055 00
Grasa de silicona	7036 77
Grasa fluorada	7036 78
PLT unit	7039 70

### Envíos para reparación

**Atención:** Transportar materiales peligrosos sin autorización está prohibido por la ley.

- Limpiar y descontaminar el aparato con cuidado.
- Devuelva el instrumento incluya generalmente una descripción exacta del tipo de avería y de los medios utilizados. En caso de no indicar los medios usados no se puede reparar el instrumento.
- Los gastos y riesgos de la devolución corren a cargo del remitente.

### Fuera de los EE.UU. y Canadá:

- Rellenar la "Declaración sobre la ausencia de riesgos para la salud" y enviarla con el aparato al fabricante o al distribuidor. Pedir el formulario al proveedor o al fabricante, o se encuentran bajo [www.brand.de](http://www.brand.de) para un download.

### En los EE.UU. y Canadá:

- Haga el favor de dirigirse a BrandTech Scientific, Inc. para aclarar las condiciones de envío del aparato **antes** de enviarlo al servicio.
- Devuelva solamente los instrumentos limpiados y descontaminados con el Número de Autorización de Devolución marcado de forma bien visible en la parte exterior del paquete, enviándolo a la dirección indicada en la autorización antedicha.

### Direcciones de contacto

#### BRAND GMBH + CO KG

Otto-Schott-Straße 25  
97877 Wertheim (Germany)  
Tel.: +49 9342 808-0  
Fax: +49 9342 808-98000  
E-Mail: [info@brand.de](mailto:info@brand.de)  
[www.brand.de](http://www.brand.de)

#### EE.UU. y Canadá:

BrandTech® Scientific, Inc.  
11 Bokum Road  
Essex, CT 06426-1506 (USA)  
Tel.: +1-860-767 2562  
Fax: +1-860-767 2563  
[www.brandtech.com](http://www.brandtech.com)

#### India:

BRAND Scientific Equipment Pvt. Ltd.  
303, 3rd Floor, 'C' Wing, Delphi  
Hiranandani Business Park, Powai  
Mumbai - 400 076 (India)  
Tel.: +91 22 42957790  
Fax: +91 22 42957791  
E-Mail: [info@brand.co.in](mailto:info@brand.co.in)  
[www.brand.co.in](http://www.brand.co.in)

#### China:

BRAND (Shanghai) Trading Co., Ltd.  
Guangqi Culture Plaza  
Room 506, Building B  
No. 2899, Xietu Road  
Shanghai 200030 (P.R. China)  
Tel.: +86 21 6422 2318  
Fax: +86 21 6422 2268  
E-Mail: [info@brand.cn.com](mailto:info@brand.cn.com)  
[www.brand.cn.com](http://www.brand.cn.com)

### Servicio de calibración

Las normas ISO 9001 y las directivas BPL exigen el control regular de sus aparatos volumétricos. Nosotros recomendamos un control cada 3-12 meses. El intervalo depende de las exigencias individuales al instrumento. En el caso de uso frecuente o del uso de medios agresivos, se debe de controlar en intervalos más cortos.

Las instrucciones de calibrado detalladas se pueden descargar de la página [www.brand.de](http://www.brand.de) o [www.brandtech.com](http://www.brandtech.com) (véase 'Documentos técnicos').

Además, BRAND le ofrece la posibilidad de calibrar sus instrumentos por medio del servicio de calibrado de BRAND o por el laboratorio de calibrado DAkkS.

Mándenos sencillamente los instrumentos a calibrar con la información qué tipo de calibrado desea. Recibirá los instrumentos con un certificado de fábrica o con un certificado de calibrado DAkkS después de pocos días. Puede obtener informaciones detalladas de su proveedor o directamente de BRAND. En la página [www.brand.de](http://www.brand.de) encontrará para descargar, los documentos de pedido (véase 'Documentos técnicos').

## Garantía

No seremos responsables de las consecuencias derivadas del trato, manejo, mantenimiento, uso incorrecto o reparación no autorizada del aparato, ni de las consecuencias derivadas del desgaste normal, en especial de partes susceptibles de abrasión, tales como émbolos, juntas hermeticas, valvulas, ni de la rotura de partes de vidrio o del incumplimiento de las instrucciones de manejo. Tampoco seremos responsables de los daños provocados de acciones no descritas en las instrucciones de manejo o por el uso piezas de repuesto o componentes no originales.

EE.UU. y Canadá:

Encontrará informaciones sobre la garantía en el sitio [www.brandtech.com](http://www.brandtech.com).

## Eliminación

---

El siguiente símbolo significa que al final de su vida útil, las pilas / acumuladores y aparatos electrónicos deben descartarse separadamente de los residuos domésticos (residuos municipales mezclados).

- Según la directiva UE 2002/96/CE del Consejo y Parlamento Europeo sobre residuos de aparatos eléctricos y electrónicos del 27 enero 2003 es necesario eliminar los aparatos eléctricos conforme a las normas correspondientes de la eliminación de residuos nacional.

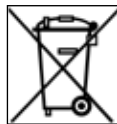

- Las pilas o acumuladores contienen sustancias que pueden resultar perjudiciales para el medio ambiente y la salud humana. Según la directiva UE 2006/66/CE del Consejo y Parlamento Europeo sobre residuos de pilas o de acumuladores del 6 septiembre 2006 es necesario eliminarlos conforme a las normas correspondientes de la eliminación de residuos nacional. Eliminar la pila / el acumulador sólo cuando esté completamente descargado.

### ¡Advertencia!

No cortocircuitar el acumulador / la pila para descargarlo.

	Pagina
Norme di sicurezza	156
Funzioni e limitazioni all'uso	157
Usi non previsti	157
<b>Elementi funzionali</b>	<b>158</b>
I primi passi	159
Regolazione del volume	160
Regolazione della velocità di aspirazione e di erogazione	161
Pipettaggio corretto	162
Programmi di pipettaggio	163
Modalità PIP	164
Modalità PIPmix	166
Modalità revPIP	168
Modalità Elettroforesi (GEL)	170
Modalità DISP	172
Verifica del volume	174
Tabella della precisione	175
<b>Easy Calibration (Calibrazione)</b>	<b>176</b>
Sterilizzazione in autoclave	178
Ciclo di riferimento (rEF)	178
Manutenzione e pulizia	179
Ricarica e sostituzione dell'accumulatore	184
Funzione di rigenera dell'accumulatore	185
Individuazione e soluzione dei problemi	186
Marchatura sullo strumento	187
Dati per l'ordinazione · Accessori · Parti di ricambio	188
Riparazione · Indirizzi di contatto	190
Servizio Calibrazione · Garanzia	191
Smaltimento	192

## Norme di sicurezza

Questo strumento può essere utilizzato con materiali, procedure e apparecchiature pericolosi.

Le istruzioni per l'uso non possono però coprire tutte le eventuali problematiche di sicurezza che possono presentarsi. È responsabilità dell'utilizzatore osservare adeguate prescrizioni per la sicurezza e la salute e definire prima dell'uso le opportune limitazioni.

### Leggere attentamente prima dell'uso!

1. Prima di utilizzare lo strumento, ogni utilizzatore deve leggere ed osservare queste istruzioni per l'uso.
2. Osservare le avvertenze generali di pericolo e le norme di sicurezza. Ad esempio indossare indumenti, protezione per gli occhi e guanti protettivi.  
Se si lavora con di campioni infetti o pericolosi devono essere rispettate le procedure e le precauzioni standard di laboratorio.
3. Rispettare le indicazioni del produttore dei reagenti.
4. Non utilizzare lo strumento in ambiente potenzialmente esplosivo e non pipettare fluidi facilmente infiammabili.
5. Utilizzare lo strumento solo per il pipettaggio di liquidi e tenere conto dei limiti d'uso definiti e delle limitazioni all'uso. Osservare gli usi non previsti (pagina 157). In caso di dubbio, rivolgersi al produttore o al distributore.
6. Procedere sempre in modo che né l'utilizzatore né altre persone siano esposte a pericoli. Evitare spruzzi e utilizzare un recipiente di raccolta adeguato.
7. Se si lavora con fluidi aggressivi, evitare il contatto con il foro del puntale.
8. Non forzare mai lo strumento.
9. Utilizzare solo parti di ricambio originali. Non apportare modifiche tecniche. Non smontare ulteriormente lo strumento, al di là di quanto previsto nelle istruzioni per l'uso!
10. Prima dell'uso controllare sempre che lo stato dello strumento sia regolare. In caso di anomalie dello strumento (ad esempio pistone poco scorrevole o mancanza di tenuta), interrompere immediatamente la pipetage e vedere il capitolo 'Individuazione e soluzione dei problemi' (pagina 186). Eventualmente rivolgersi al produttore.
11. L'accumulatore originale non deve essere sostituito con accumulatori non ricaricabili o con accumulatori ricaricabili di altri produttori.
12. Per la ricarica degli accumulatori al nichel-metal-idruro utilizzare esclusivamente l'alimentatore originale.
13. L'alimentatore deve essere protetto dall'umidità e deve essere usato solo per questo apparecchio.
14. Smaltire solo accumulatori completamente scarichi, rispettando le prescrizioni per lo smaltimento delle le batterie.

### Attenzione!

L'uso improprio dello strumento o dell'accumulatore (corto circuito, danni meccanici, surriscaldamento, alimentatore sbagliato, ecc.) può portare, in casi estremi, all'esplosione dell'accumulatore.

La Transferpette®-8/-12 electronic è una pipetta multicanale a pistone a cuscinetto d'aria, controllata da un microprocessore e alimentata a batteria, per il pipettaggio di soluzioni acquose di media densità e viscosità.

Nell'uso corretto dello strumento soltanto i puntali vengono a contatto con il campione da dosare, mai la Transferpette®-8/-12 electronic.

### Limiti all'uso

Lo strumento può essere utilizzato per il pipettaggio di campioni con le seguenti limitazioni:

- Temperatura di uso da +15 °C a +40 °C (da 59 °F a 104 °F) dello strumento e del reagente (per temperature diverse chiedere informazioni)
- tensione di vapore fino a 500 mbar
- viscosità: 260 mPa s

### Usi non previsti

L'utente è tenuto a verificare personalmente la compatibilità dello strumento con l'uso previsto.

Non usare mai lo strumento per il pipettaggio di liquidi che possono aggredire il polipropilene, polivinilidenefluoruro e silicone (gambo e puntali), il policarbonato-polibutilenetereftalato (alloggiamento) o EPDM (gambi della pipetta di ricambio flessibile). Evitare vapori aggressivi (pericolo di corrosione)!

L'impugnatura non può essere sterilizzata in autoclave!

### Limitazioni all'uso

I liquidi viscosi e bagnanti possono compromettere la precisione del volume. Ciò è valido anche per i liquidi la cui temperatura si discosta di più di  $\pm 5$  °C / 41 °F dalla temperatura ambiente.

### Caratteristiche dell'accumulatore e dell'alimentatore

#### Accumulatore

Accumulatore al nichel-metal-idruro con 3 pile cilindriche di tipo AAA, 3,6 V, 700 mAh

#### Alimentatore

Tensione in uscita 6,5 V DC, 200 mA

## Elementi funzionali

La Transferpette®-8/-12 electronic è una pipetta a pistone multicanale, ottimizzata dal punto di vista ergonomico e della facilità d'uso, controllata da un microprocessore e alimentata a batteria.

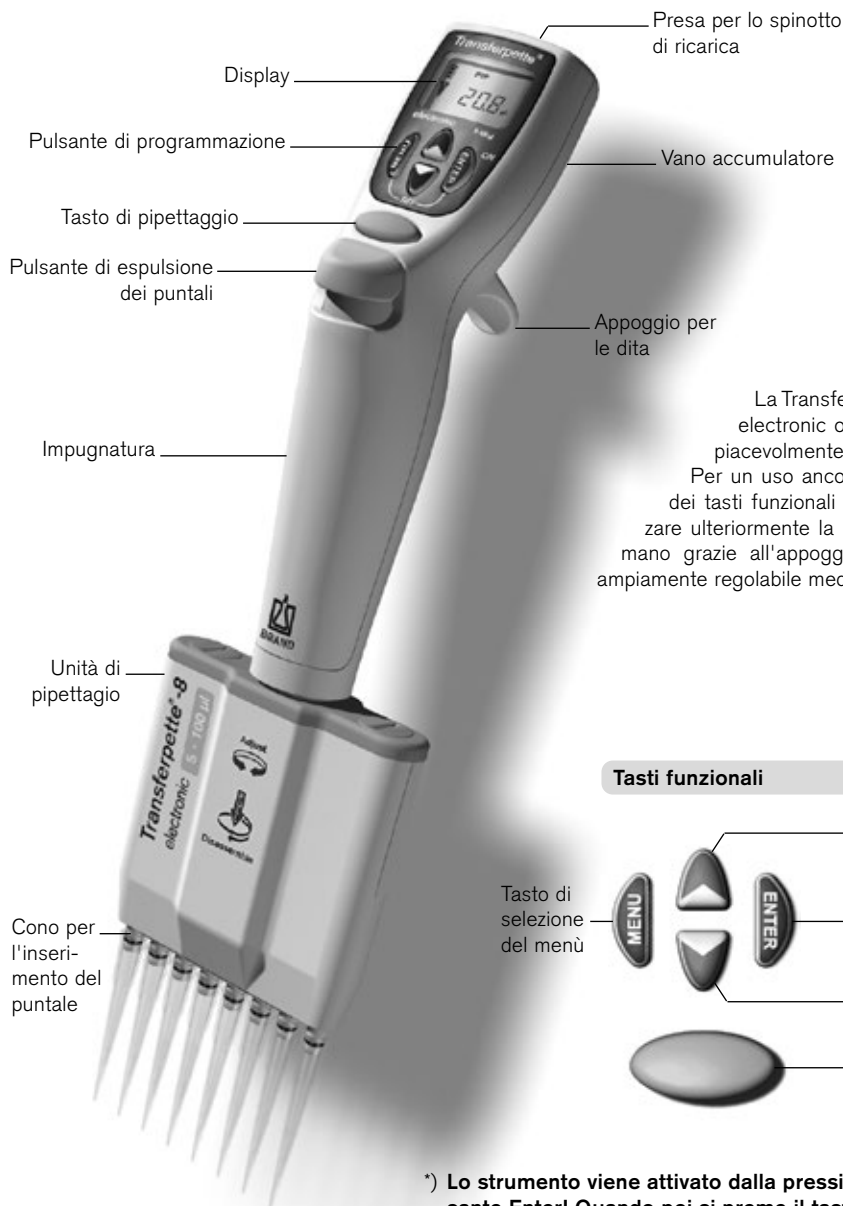

La Transferpette®-8/-12 electronic offre una presa piacevolmente ergonomica. Per un uso ancora più agevole dei tasti funzionali si può ottimizzare ulteriormente la posizione della mano grazie all'appoggio per le dita ampiamente regolabile mediante una vite.

### Tasti funzionali

\*) **Lo strumento viene attivato dalla pressione del pulsante Enter! Quando poi si preme il tasto di pipettaggio, lo strumento è pronto.**

La Transferpette®-8/-12 electronic si spegne automaticamente 10 minuti dopo l'ultimo utilizzo (Auto-Power-Off).



**C'è tutto nella confezione?**

Nella confezione sono contenuti: la vostra Transferpette®-8 o -12 electronic, un accumulatore, l'alimentatore con il relativo cavo, 1 supporto per lo strumento, 1 serbatoio per reagenti, grasso al silicone, queste istruzioni per l'uso e 1 O-Ring in silicone di ricambio.

**Messa in funzione della Transferpette®-8/-12 electronic****1. Inserire l'accumulatore**

- Aprire il vano accumulatore.
- Inserire l'accumulatore. Assicurarsi che il contatto dell'accumulatore sia inserito correttamente nella presa dello strumento.
- Reinserire il coperchio e chiudere il vano accumulatore.

**2. Attivare lo strumento**

Subito dopo l'introduzione dell'accumulatore, la Transferpette®-8/-12 electronic richiede automaticamente un ciclo di riferimento. Premere il tasto di pipettaggio: il ciclo di riferimento viene eseguito e lo strumento è pronto!

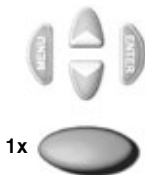

1x



Il Display mostra la modalità standard di pipettaggio (PIP) (impostazione di fabbrica) e il volume nominale corrente. (qui ad esempio 100,0 µl). Le velocità di aspirazione e di erogazione sono impostate di fabbrica al valore massimo. La semplice procedura di impostazione del volume e della velocità è descritta nelle pagine seguenti.

Modalità di pipettaggio

Visualizzazione della carica







Freccia per l'indicazione di "Aspirazione"

Indicazione del volume



## Regolazione del volume

Il volume viene impostato in fabbrica al volume nominale della Transferpette®-8/-12 electronic e può essere modificato autonomamente in modo facile e veloce.

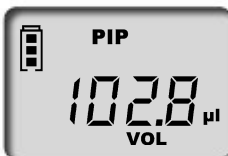
Cosa devo fare?	Come fare?	Quale tasto?	Cosa mostra il display?
<b>1. Attivare la scelta del volume</b>	Premendo una delle frecce si sceglie direttamente un volume. 'VOL' lampeggia.		
<b>2. Regolare il volume</b>			
<b>diminuire</b>	Premendo la freccia (-) si diminuisce il volume. Tenendo premuta la freccia aumenta la velocità della variazione del volume. 'VOL' lampeggia ancora.		
<b>aumentare</b>	Premendo la freccia (+) si aumenta il volume. Tenendo premuta la freccia aumenta la velocità della variazione del volume. 'VOL' lampeggia ancora.		
<b>3. Confermare il volume scelto</b>	Premere il tasto Enter. Il display mostra ora il nuovo volume impostato, qui ad esempio nella modalità standard PIP.		

### Importante:





Premendo il tasto menù si può interrompere qualsiasi procedura di regolazione! Il display salta quindi alla prossima possibile regolazione o alla visualizzazione di uscita.

## Regolazione velocità di aspirazione/erogazione



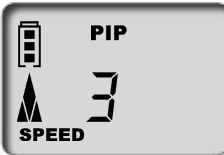

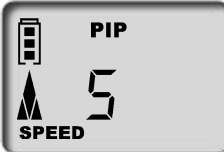
Le velocità di aspirazione e di erogazione possono essere impostate in modo indipendente. Richiamando il menù viene mostrata la velocità impostata per ultima. Sono disponibili 5 livelli di velocità.

Cosa devo fare?	Come fare?	Quale tasto?	Cosa mostra il display?
-----------------	------------	--------------	-------------------------

### Impostare la velocità di aspirazione

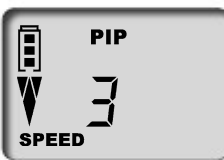
- |   |  |  |  |
|---|--|--|--|
| 1. Richiamare il menù                   | Premendo brevemente una volta il tasto Menù si accede al menù di impostazione della velocità di aspirazione. 'Speed' lampeggia.                                | 1x  |  |
| 2. Impostare la velocità di aspirazione | Premendo le frecce (+/-) si imposta il livello di velocità (ad esempio: livello 5). 'Speed' lampeggia ancora.  |     |  |
| 3. Confermare il livello della velocità | Premere il tasto Enter. Il display torna alla visualizzazione di base della modalità prescelta, qui ad esempio la visualizzazione della modalità standard PIP. |  1x |  |

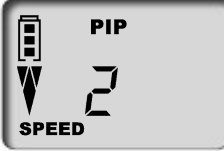
### Impostare la velocità di erogazione

- |   |  |  |  |
|---|--|--|--|
| 1. Richiamare il menù                   | Premendo brevemente due volte il tasto Menù si accede al menù di impostazione della velocità di erogazione. 'Speed' lampeggia.                                 | 2x   |   |
| 2. Impostare la velocità di erogazione  | Premendo le frecce (+/-) si imposta il livello di velocità (ad esempio: livello 2). 'Speed' lampeggia ancora.  |     |  |
| 3. Confermare il livello della velocità | Premere il tasto Enter. Il display torna alla visualizzazione di base della modalità prescelta, qui ad esempio la visualizzazione della modalità standard PIP. |  1x |  |

Il volume viene impostato in fabbrica al volume nominale della Transferpette®-8/-12 electronic e può essere modificato autonomamente in modo facile e veloce (vedere pagina 160).

## Quick Start nella modalità di pipettaggio standard

### 1. Inserire i puntali

Scegliere i puntali adatti in base al range di volume prescelto e al color-code! Assicurarsi che i puntali siano inseriti ermeticamente e saldamente sulla pipetta. I puntali sono articoli monouso!

### 2. Rimontare l'unità di pipettaggio

L'unità di pipettaggio può ruotare liberamente in ambidue le direzioni.

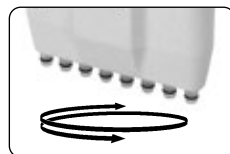

### 3. Aspirare il liquido



Tenere lo strumento verticale e immergere i puntali nel liquido per 2-3 millimetri.

Premere il tasto di pipettaggio per aspirare il liquido. La freccia del display è rivolta verso l'alto (aspirazione).



**Nota:** Per non aspirare aria mantenere ancora immersi i puntali per 1 sec.

### 4. Erogare il liquido

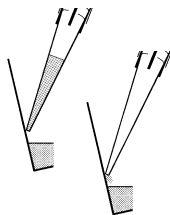

Alla fine dell'erogazione la freccia del display è rivolta verso il basso (erogazione).

Appoggiare i puntali della pipetta alla parete del recipiente. Tenere la pipetta ad un angolo di 30-45°.

Premere di nuovo il tasto di pipettaggio per espellere completamente il liquido, con scarico automatico. Strofina poi i puntali sulla parete.



### 5. Espellere i puntali

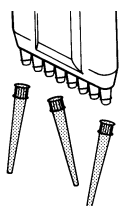

Tenere l'unità di pipettaggio sopra un recipiente adatto allo smaltimento e premere il tasto di espulsione dei puntali.

Tasto di espulsione dei puntali











**Nota:**

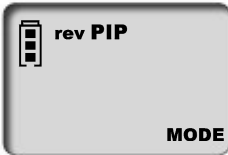

La norma ISO 8655 prescrive un risciacquo dei puntali con un liquido di prova prima della procedura di pipettaggio del campione.

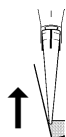

	Pagina
<b>1. Pipettaggio normale</b>	
Modalità <b>PIP</b> _____	<b>164</b>
Programma standard. Un volume prestabilito viene prima aspirato e poi erogato.	
<b>2. Mescolamento dei campioni</b>	
Modalità <b>PIPmix</b> _____	<b>166</b>
Programma per la risospensione di liquidi. Il campione viene aspirato e scaricato ripetutamente.	
<b>3. Pipettaggio inverso</b>	
Modalità <b>revPIP</b> _____	<b>168</b>
Programma particolarmente adatto per il pipettaggio di liquidi molto viscosi, ad alta tensione di vapore o schiumosi.	
<b>4. Pipettaggio per elettroforesi</b>	
Modalità <b>GEL</b> _____	<b>170</b>
Programma per aspirare i gel per elettroforesi. Un volume variabile di campione viene aspirato con velocità alta e regolabile, poi viene scaricato lentamente.	
<b>5. Dosaggio</b>	
Modalità <b>DISP</b> _____	<b>172</b>
Programma per il dosaggio di liquidi. Il volume aspirato viene erogato dose per dose.	

È il programma standard – un volume prestabilito viene prima aspirato e poi scaricato.  
La regolazione del volume e della velocità è descritta alle pagine 160 e 161.

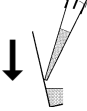
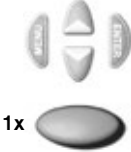
Cosa devo fare?	Come fare?	Quale tasto?	Cosa mostra il display?
<b>1. Richiamare il menù</b>	Premendo brevemente tre volte il tasto Menù si accede alla selezione del programma. <b>'Mode'</b> lampeggia.	3x 	
<b>2. Impostare la modalità PIP</b>	Premere una delle frecce per scorrere la lista delle modalità finché compare <b>'PIP'</b> . <b>'Mode'</b> lampeggia ancora.		
<b>3. Confermare la modalità PIP</b>	Premere il tasto Enter. Il Display mostra ora <b>'blo'</b> per blow-out (scarico).	 1x	
<b>4. Preparare il pipettaggio</b>	Premere una volta il tasto di pipettaggio per portare il pistone alla sua posizione di partenza. La freccia del display è rivolta verso l'alto (aspirazione).	 1x	
<b>5. Aspirare il liquido</b>	Premere una volta il tasto di pipettaggio per aspirare il liquido.	 1x	







Cosa devo fare?	Come fare?	Quale tasto?	Cosa mostra il display?
<p><b>6. Erogare il liquido</b></p> 	<p>Premere una volta il tasto di pipettaggio per erogare il liquido. La freccia del display è rivolta verso il basso (erogazione).</p>	 <p>1x</p>	

<p><b>7. Attivare lo scarico?</b></p>	<p><b>Non dovete fare niente!</b> Nel pipettaggio in modalità PIP lo scarico (blow-out) è automatico!</p>	 <p>1x</p>	
---------------------------------------	---	---	--

## Attivare lo scarico direttamente

Se necessario, lo scarico (blow-out) può essere attivato in qualunque momento anche direttamente.

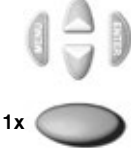
<p><b>1. Richiamare la funzione di scarico</b></p>	<p>Premere il tasto Enter. Il display mostra 'blo' per blow-out (scarico).</p>	 <p>1x</p>	
--	--	--	---

<p><b>2. Attivare lo scarico</b></p>	<p>Premere una volta il tasto di pipettaggio per attivare lo scarico. Il display salta alla modalità di pipettaggio già impostata (posizione iniziale).</p>	 <p>1x</p>	
--------------------------------------	---	---	--

### Nota:

Nello scarico (blow-out) i pistoni si spostano verso il basso completamente. Assicurarsi che i possibili residui vengano scaricati senza creare pericolo. **Tenendo premuto il tasto di pipettaggio si tengono premuti in basso i pistoni, evitando così l'aspirazione accidentale del liquido. Rilasciandolo si riportano i pistoni alla posizione di partenza.**

Programma per la risospensione di liquidi.

Il campione viene aspirato ed erogato ripetutamente.

La regolazione del volume e della velocità è descritta alle pagine 160 e 161.

Cosa devo fare?	Come fare?	Quale tasto?	Cosa mostra il display?
1. Richiamare il menù	Premendo brevemente tre volte il tasto Menù si accede alla selezione del programma. <b>'Mode'</b> lampeggia.	3x	
2. Impostare la modalità PIPmix	Premere una delle frecce per scorrere la lista delle modalità finché compare <b>'PIPmix'</b> . <b>'Mode'</b> lampeggia ancora.		
3. Confermare la modalità PIPmix	Premere il tasto Enter. Il display mostra ora <b>'blo'</b> per blow-out (scarico).	1x	
4. Preparare il pipettaggio	Premere una volta il tasto di pipettaggio per portare i pistoni alla posizione di partenza. La freccia del display è rivolta verso l'alto (aspirazione).	1x	
5. Aspirare il liquido	Premere una volta il tasto di pipettaggio per aspirare il liquido.	1x	

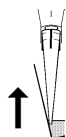



Cosa devo fare?	Come fare?	Quale tasto?	Cosa mostra il display?
-----------------	------------	--------------	-------------------------

## 6. Erogare il liquido in modalità PIPmix

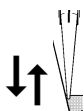

Premere il tasto di pipettaggio per attivare una sequenza di erogazioni e aspirazioni del liquido. Sul display si alternano le frecce di indicazione dell'aspirazione e dell'erogazione e viene indicato il numero di cicli eseguiti.



## 7. Fine del pipettaggio









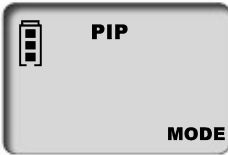

Premere una volta il tasto di pipettaggio per erogare il liquido e attivare lo scarico (blow-out).

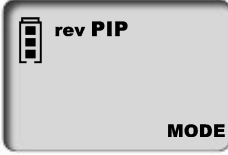
Dopo lo scarico (blow-out) dei residui di liquido, il display salta alla modalità di pipettaggio già impostata (posizione iniziale).







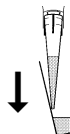
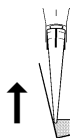

**Nota:** Il display mostra al massimo 19 cicli.

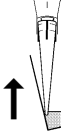
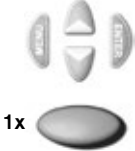
Programma particolarmente adatto per il pipettaggio di liquidi molto viscosi, ad alta tensione di vapore o schiumosi. La regolazione del volume e della velocità è descritta alle pagine 160 e 161.

Cosa devo fare?	Come fare?	Quale tasto?	Cosa mostra il display?
1. Richiamare il menù	Premendo brevemente tre volte il tasto Menù si accede alla selezione del programma. 'Mode' lampeggia.	3x 	
2. Impostare la modalità revPIP	Premere una delle frecce per scorrere la lista delle modalità finché compare 'revPIP'. 'Mode' lampeggia ancora.		
3. Confermare la modalità revPIP	Premere il tasto Enter. Il Display mostra ora 'blo' per blow-out (scarico).	 1x	
4. Preparare il pipettaggio	Premere una volta il tasto di pipettaggio per portare i pistoni alla posizione di partenza. La freccia del display è rivolta verso l'alto (aspirazione).	 1x	
5. Aspirare il liquido	Premere ancora una volta il tasto di pipettaggio per aspirare un volume un po' maggiore di quello impostato!	 1x	
6. Erogare il liquido in modalità revPIP	Premere una volta il tasto di pipettaggio per erogare. La freccia del display è rivolta verso il basso (erogazione). Ora il volume impostato viene erogato e rimane un po' di liquido nei puntali.	 1x	

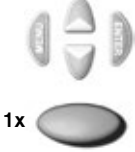









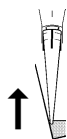

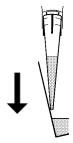



Cosa devo fare?	Come fare?	Quale tasto?	Cosa mostra il display?
<p>7. Aspirare di nuovo il liquido in modalità revPIP</p> 	<p>Premendo ancora una volta il tasto di pipettaggio viene ora aspirato di nuovo il volume impostato. (La successiva pressione del tasto di pipettaggio eroga di nuovo il volume, e così via)</p>		
<p>8. Attivare lo scarico</p>	<p>Dopo l'ultimo pipettaggio premere il tasto Enter. Il Display mostra ora di nuovo 'blo' per blow-out (scarico).</p>		
	<p>Premere una volta il tasto di pipettaggio per attivare lo scarico (blow-out) ed espellere i residui di liquido.</p>		
<p>9. Fine del pipettaggio</p>	<p>Dopo lo scarico (blow-out) dei residui di liquido, il display salta alla modalità di pipettaggio già impostata (posizione iniziale).</p>		

Programma per aspirare i gel per elettroforesi. Un volume variabile di campione viene aspirato con velocità alta e regolabile, poi viene erogato lentamente.

La regolazione del volume e della velocità è descritta alle pagine 160 e 161.

Cosa devo fare?	Come fare?	Quale tasto?	Cosa mostra il display?
1. Richiamare il menù	Premendo brevemente tre volte il tasto Menù si accede alla selezione del programma. 'Mode' lampeggia.	3x	
2. Impostare la modalità GEL	Premere una delle frecce per scorrere la lista delle modalità finché compare 'GEL'. 'Mode' lampeggia ancora.		
3. Confermare la modalità GEL	Premere il tasto Enter. Il Display mostra ora 'blo' per blow-out (scarico).	1x	
4. Preparare il pipettaggio	Premere una volta il tasto di pipettaggio per portare i pistoni alla posizione di partenza. La freccia del display è rivolta verso l'alto (aspirazione).	1x	
5. Aspirare il liquido	Premere una volta il tasto di pipettaggio per aspirare il liquido. Il volume impostato viene aspirato.	1x	
	<b>Aspirare un volume maggiore</b> Per aspirare più liquido di quanto impostato (fino ad un massimo del 110 % del volume nominale), tenere premuto il tasto di pipettaggio durante l'aspirazione, finché viene aspirato il volume desiderato. Il display mostra un rombo.	tenere premuto	

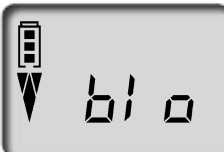









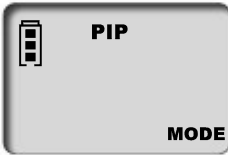

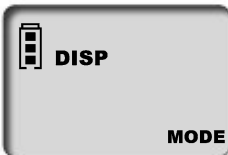
Cosa devo fare?	Come fare?	Quale tasto?	Cosa mostra il display?
<p><b>6. Erogare il liquido in modalità GEL</b></p> 	<p>Premere una volta brevemente il tasto di pipettaggio. Il display mostra un rombo. Il volume aspirato viene erogato lentamente.</p>	 1x 	
	<p><b>Interrompere l'erogazione</b> L'erogazione del campione può essere interrotta mediante pressione ripetuta del tasto di pipettaggio. In questo caso il display mostra il volume della quantità erogata.</p>	 1x 	
<p><b>7. Attivare lo scarico</b></p>	<p>Dopo l'ultimo pipettaggio premere il tasto Enter. Il Display mostra ora di nuovo 'blo' per blow-out (scarico).</p>	 1x 	
	<p>Premere una volta il tasto di pipettaggio per attivare lo scarico (blow-out) ed espellere i residui di liquido.</p>	 1x 	
<p><b>8. Fine del pipettaggio</b></p>	<p>Dopo lo scarico (blow-out) dei residui di liquido, il display salta alla modalità di pipettaggio già impostata (posizione iniziale).</p>		

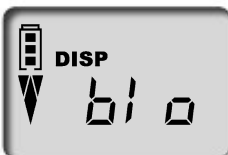
**Nota:**

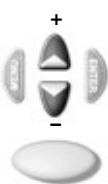
La modalità GEL richiede velocità di erogazione molto basse per evitare di creare turbolenza. Per assicurare un'erogazione ottimale la velocità di erogazione è impostata in fabbrica. È sensibilmente ridotta rispetto al livello 1 e non può essere impostata autonomamente dall'utilizzatore.

Programma per l'erogazione dose per dose del liquido aspirato.  
Viene aspirato un po' più di liquido di quanto richiesto in base al calcolo.  
La regolazione della velocità è descritta a pagina 161.

Cosa devo fare?	Come fare?	Quale tasto?	Cosa mostra il display?
1. Richiamare il menù	Premendo brevemente tre volte il tasto Menù si accede alla selezione del programma. 'Mode' lampeggia.	3x 	
2. Impostare la modalità DISP	Premere una delle frecce per scorrere la lista delle modalità finché compare 'DISP'. 'Mode' lampeggia ancora.		
3. Confermare la modalità DISP	Premere il tasto Enter. Il Display mostra ora 'blo' per blow-out (scarico).	 1x	
4. Preparare il dosaggio	Premere una volta il tasto di pipettaggio per portare i pistoni alla posizione di partenza. La freccia del display è rivolta verso l'alto (aspirazione).	 1x	
5. Impostare il volume parziale	Premendo le frecce (+/-) si regola il volume. Tenendo premuta la freccia aumenta la velocità della variazione del volume. 'VOL' lampeggia.		
6. Confermare il volume parziale	Premere il tasto Enter. Il display mostra il nuovo volume parziale impostato. 'steps' lampeggia. Viene visualizzato il massimo numero di step consentito.	 1x	

Cosa devo fare?	Come fare?	Quale tasto?	Cosa mostra il display?
7. Impostare il numero di step	Premendo le frecce (+/-) si regola il numero di step. 'steps' lampeggia ancora.		
8. Confermare il numero di step	Premere il tasto Enter. Il display mostra il numero di step impostati.		
9. Aspirare il liquido	Premere una volta il tasto di pipettaggio per aspirare il liquido.		
10. Erogare il liquido	Ad ogni pressione del tasto di pipettaggio corrisponde uno step di erogazione. La freccia del display è rivolta verso il basso (erogazione). L'indicazione di step mostra il numero di step rimanenti.		
11. Attivare lo scarico	Dopo l'ultimo step di erogazione premere il tasto Enter. Il Display mostra ora 'blo' per blow-out (scarico). Infine premere ancora una volta il tasto di pipettaggio per attivare lo scarico (blow-out) (vedere anche a pagina 171).		
12. Fine del dosaggio	Dopo lo scarico (blow-out) dei residui di liquido, il display salta alla modalità di pipettaggio già impostata (posizione iniziale).		

## Verifica del volume

Si consiglia, in base all'impiego, una verifica dello strumento ogni 3-12 mesi. L'intervallo dipende comunque dalle prestazioni richieste allo strumento.

La verifica gravimetrica del volume va eseguita secondo la seguente procedura, secondo la norma DIN EN ISO 8655, parte 6.

### 1. Impostare il volume nominale

Impostare il volume massimo indicato sullo strumento.  
Per la procedura vedere a pagina 160.

### 2. Condizionare la pipetta

Condizionare la pipetta prima della verifica aspirando e rilasciando il liquido di prova (H<sub>2</sub>O distillata) con i puntali per cinque volte. Poi espellere i puntali.

### 3. Eseguire la verifica

- Inserire puntali nuovi e risciacquarli una volta con il liquido di prova.
- Aspirare il liquido di prova e pipettarlo nel contenitore per la pesata.

**Nota:** Ogni singolo canale deve essere verificato separatamente.

- Pesare la quantità di campione pipettata con una bilancia analitica. (Rispettare le istruzioni per l'uso del produttore della bilancia).
- Calcolare il volume pipettato, tenendo conto della temperatura.
- Si raccomanda di eseguire per ogni canale 3-10 pesate in 3 range di volume (100 %, 50 %, 10 %).

#### Calcolo (per il volume nominale)

$x_i$  = risultato della pesata  
 $n$  = numero delle pesate

$Z$  = fattore di correzione  
(es. 1,0029 µl/mg a 20 °C, 1013 hPa)

$$\text{Valor médio } \bar{x} = \frac{\sum x_i}{n}$$

$$\text{Volume médio } \bar{V} = \bar{x} \cdot Z$$

#### Accuratezza\*

$$A\% = \frac{\bar{V} - V_0}{V_0} \cdot 100$$

$V_0$  = volume nominale

#### Deviazione standard

$$s = Z \cdot \sqrt{\frac{\sum (x_i - \bar{x})^2}{n - 1}}$$

#### Coefficiente di variazione\*

$$CV\% = \frac{100 s}{\bar{V}}$$

\*) = Calcolo dell'accuratezza (A%) e del coefficiente di variazione (CV%):  
A% e CV% vengono calcolati in base a formule del controllo statistico di qualità.



## Tabella della precisione

I valori finali si riferiscono ai volumi nominali (= volumi massimi) e i volumi parziali indicati riportati sullo strumento, con pipetta, ambiente e acqua distillata alla stessa temperatura (20 °C). Secondo la norma DIN EN ISO 8655.

CE



20 °C  
Ex

### Precisione della Transferpette®-8/-12 electronic

Range di volume µl	Volume parziale µl	A* ≤ ± %	CV* ≤ %	Divisione µl	Tipo di puntale rac., µl
0,5 - 10	10	1,2	0,8	0,01	0,5 - 20
	5	2,0	1,5		
	1	8,0	4,0		
1 - 20	20	1,0	0,5	0,02	0,5 - 20
	10	2,0	1,0		
	2	8,0	3,0		
5 - 100	100	0,8	0,25	0,1	2 - 200
	50	1,6	0,4		
	10	4,0	1,5		
10 - 200	200	0,8	0,25	0,2	2 - 200
	100	1,4	0,4		
	20	4,0	1,3		
15 - 300	300	0,6	0,25	0,5	5 - 300
	150	1,2	0,4		
	30	3,0	1,2		

\* A = Accuratezza, CV = Coefficiente di variazione

#### Nota:

Le Procedure operative standard (SOP) e una versione demo del software di calibrazione EASYCAL™ 4.0 possono essere scaricate da [www.brand.de](http://www.brand.de).

## La modalità "CAL"

### Calibrazione

È impostato il volume nominale o uno specifico volume, ad esempio 100,0 µl, con modalità di pipettaggio standard (PIP) (vedere a pagina 160, 164 per la procedura).

Ad esempio: volume corrispondente a la verifica del volumen 101,3 µl.



Cosa devo fare?	Come fare?	Quale tasto?	Cosa mostra il display?
1. <b>Richiamare la modalità CAL</b>	Tenendo premuto (più di 3 sec.) il tasto Menù si richiama la modalità CAL. Il display mostra "off". 'CAL' lampeggia.	1x >3s 	
2. <b>Attivare la modalità CAL</b>	Premere una delle frecce per attivare la modalità CAL. L'indicazione da "off" diventa "on". 'CAL' lampeggia ancora.		
3. <b>Confermare la modalità CAL</b>	Premere il tasto Enter. Il display mostra ora il volume impostato per il pipettaggio. 'CAL' lampeggia.	1x	
4. <b>Regolare il volume</b>	Mediante le frecce (+/-) impostare il volume che è stato in precedenza determinato e verificato. 'CAL' lampeggia.		
5. <b>Confermare il volume</b>	Premere il tasto Enter. Sul display compaiono il volume misurato e quello corretto. Il simbolo CAL è ora fisso a conferma che la calibrazione è stata effettuata.	1x	

## Ripristino delle impostazioni di fabbrica

Il simbolo CAL fisso sul display indica che è stata eseguita una calibrazione.



Cosa devo fare?	Come fare?	Quale tasto?	Cosa mostra il display?
-----------------	------------	--------------	-------------------------

### 1. Richiamare la modalità CAL

Tenendo premuto (più di 3 sec.) il tasto Menù si richiama la modalità CAL. Il display mostra "on". 'CAL' lampeggia.

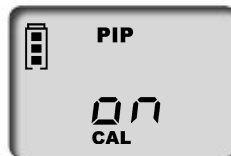

### 2. Terminare la modalità CAL

Premere una delle frecce per disattivare la modalità CAL. Il display passa da "on" a "off". 'CAL' lampeggia ancora.



### 3. Ripristinare le impostazioni di fabbrica

Premere il tasto Enter. Il simbolo CAL fisso è scomparso. Lo strumento ha ora di nuovo l'impostazione di fabbrica.



### Importante:

Con la calibrazione della Transferpette®-8/-12 electronic viene eseguito un offset del volume, cioè il volume viene modificato di una stessa quantità nell'intero range di volume della pipetta. Si raccomanda di eseguire la calibrazione al 50% del volume nominale.

### Nota:

Lo strumento è calibrato in modo permanente per soluzioni acquose, ma può anche essere calibrato per soluzioni con diversa densità, viscosità e temperatura. La Transferpette®-8/-12 electronic può essere calibrata in qualsiasi modalità (con l'eccezione della modalità GEL).

## Sterilizzazione in autoclave

L'unità di pipettaggio qui rappresentata (P) della Transferpette®-8/-12 electronic può essere interamente sterilizzata in autoclave a 121 °C (2 bar) e tempo di permanenza di almeno 15 min secondo la norme DIN EN 285.

**Attenzione:** L'impugnatura non può essere sterilizzata in autoclave!

1. Espellere i puntali dalla pipetta.
2. Svitare l'unità di pipettaggio dall'impugnatura (vedere pag. 180).
3. Sterilizzare tutto l'unità di pipettaggio senza ulteriore smontaggio.
4. Lasciar raffreddare ed asciugare completamente l'unità di pipettaggio.
5. Avvitare di nuovo l'unità di pipettaggio all'impugnatura (vedere pag. 180).
6. Eseguire un ciclo di riferimento (rEF).

**Nota:** È responsabilità dell'utilizzatore controllare l'efficacia della sterilizzazione in autoclave. Per una maggiore sicurezza servisi della sterilizzazione a vuoto. Consigliamo l'uso di sacchetti appositi per la sterilizzazione.

In caso di frequenti trattamenti in autoclave dell'unità di pipettaggio, i pistoni devono essere oliati per garantirne la scorrevolezza, usando il grasso al silicone fornito con lo strumento.

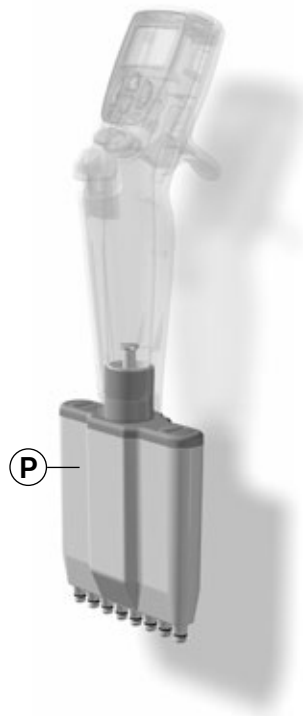

## Ciclo di riferimento (rEF)

Dopo ogni sostituzione dell'unità di pipettaggio eseguire un ciclo di riferimento. Il ciclo di riferimento serve ad assicurare il corretto accoppiamento dei pistone.

Cosa devo fare?	Come fare?	Quale tasto?	Cosa mostra il display?
1. <b>Richiamare la modalità rEF</b>	Premere contemporaneamente i tasti Menù e Enter per attivare la modalità rEF.		
2. <b>Eseguire il ciclo di riferimento</b>	Premere una volta il tasto di pipettaggio per attivare il ciclo di riferimento. Si sente distintamente il rumore del funzionamento.		

**Nota:** Dopo il ciclo di riferimento il display torna automaticamente al programma impostato in precedenza.

I tre componenti principali dell'unità di pipettaggio possono essere facilmente separati e smontati per operazioni di manutenzione, pulizia o sostituzione. La procedura è descritta e illustrata nelle pagine seguenti.

**Nota:** La sostituzione del V-Ring/O-Ring dei singoli gambi viene descritta nell'allegato che descrive le parti di ricambio

## Componenti principali dell'unità di pipettaggio

- A** **Assieme del pistone** con il suo supporto [I] ed i pistoni in esso inseriti, che possono essere svitati singolarmente per la pulizia o la sostituzione
- B** **Assieme dei gambi** con il suo supporto [II], l'asta centrale di guida (Z) montata su questo, i gambi e le guarnizioni, che possono essere svitati singolarmente per la pulizia o la sostituzione
- C** **Alloggiamento** fissato con due fermi a vite al coperchio [III] dell'assieme del pistone

## Manutenzione

Per assicurare un funzionamento perfetto, la Transferpette® -8/-12 electronic dovrebbe essere sottoposta regolarmente a manutenzione e pulizia.

### Cosa si deve verificare?

1. Controllare che i gambi, i pistoni e le guarnizioni non siano danneggiati e non siano sporchi.
2. Controllare la tenuta dello strumento: Raccomandiamo utilizzare lo strumento per prove di tenuta PLT unit di BRAND. Alternativo: aspirare del campione, tenere lo strumento verticale per circa 10 secondi. Se si formano delle gocce sui puntali: "Individuazione e soluzione dei problemi", pagina 186.

### Consigli per la pulizia (pagina 180-183)

1. Pulire i singoli gambi, i pistoni e il supporto di gambi e pistoni (**solo questi**) con soluzione saponata o con isopropanolo e poi sciacquare con acqua distillata.
2. Lasciar asciugare e raffreddare completamente i componenti. L'umidità residua nei gambi può portare a perdita di precisione.
3. Ingrassare leggermente i pistoni con l'grasso al silicone fornito con lo strumento. Per ingrassare l'asta centrale di guida (Z) utilizzare esclusivamente il grasso fluorato prescritto!
4. Dopo aver rimontato lo strumento, eseguire un ciclo di riferimento (rEF).

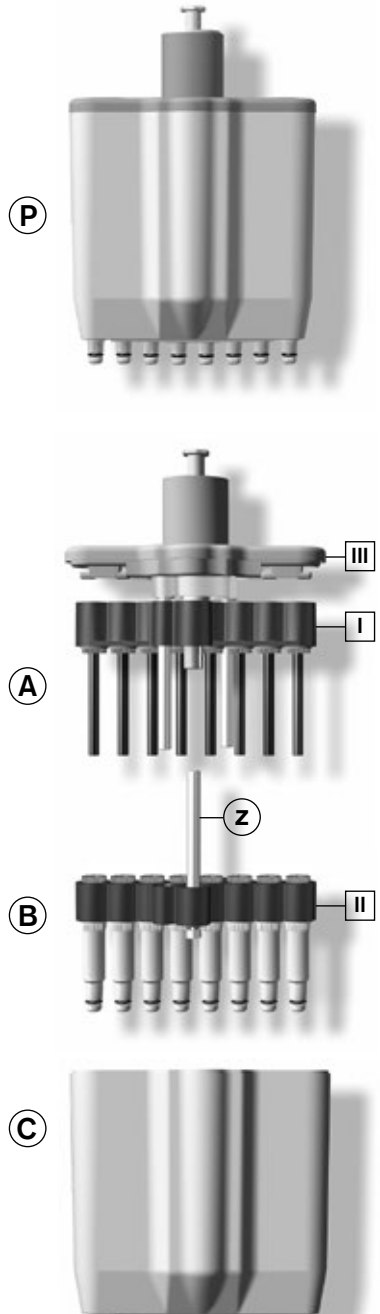

## Manutenzione e pulizia

### Smontaggio impugnatura - unità di pipettaggio

1. Espellere i puntali dalla pipetta.
2. Per sbloccare, prima spingere verso il basso l'unità di pipettaggio e poi ruotare in senso orario.  
Dopo il primo giro, ruotare senza più spingere verso il basso.
3. In caso di essere svitato l'unità di pipettaggio, springere nuovamente verso il basso per sciogliere il magnete.

#### Nota:

L'unità di pipettaggio deve essere avvitata all'impugnatura in senso anti-orario finché si sente uno scatto.

Durante il montaggio, non tirare verso il basso l'unità di pipettaggio!

#### Attenzione:

Una manovra impropria può provocare danni!



### Smontaggio di gambi e guarnizioni per la pulizia o la sostituzione

1. **Svitare l'unità di pipettaggio**      Svitare l'unità di pipettaggio dall'impugnatura.

2. **Rimuovere l'alloggiamento delle pipette**      Ruotare di 90° le due chiusure del coperchio dell'alloggiamento delle pipette e rimuovere l'alloggiamento.

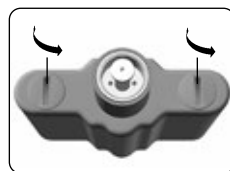

3. **Svitare gambo**      Inserire la chiave per il montaggio sul singolo gambo e svitarlo.

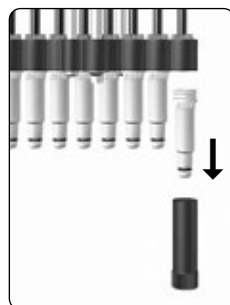

## 4. Rimuovere la guarnizione

Spingere completamente in basso l'assieme del pistone. Rimuovere e verificare la guarnizione. Se necessario pulirla o sostituirla

**Nota:**

Dopo lo smontaggio del gambo, la guarnizione può rimanere sul gambo o sul pistone.

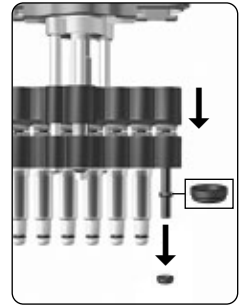

## 5. Montare la guarnizione

Se necessario ingrassare leggermente i pistoni con dell'grasso al silicone fornito con lo strumento. Inserire le guarnizioni sui pistoni con la parte piana rivolta verso l'alto. Avvitare i gambi puliti o nuovi con la chiave per il montaggio.

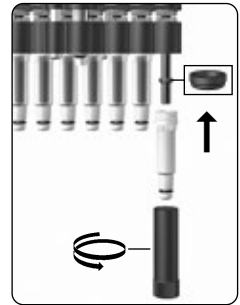

## 6. Riassemblare l'unità di pipettaggio

Riassemblare l'unità di pipettaggio e montarla sull'impugnatura.

**Nota:**

L'unità di pipettaggio deve essere avvitata all'impugnatura in senso anti-orario finché si sente uno scatto.

Non tirare verso il basso l'unità di pipettaggio.

Verificare la tenuta, la scorrevolezza e la precisione dello strumento (vedere pagina 179 "Manutenzione").

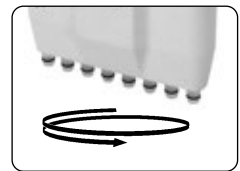

## 7. Eseguire il ciclo di riferimento

Eseguire il ciclo di riferimento (rEF).

## Smontaggio dei pistoni per la pulizia o la sostituzione

### 1. Svitare l'unità di pipettaggio

Svitare l'unità di pipettaggio dall'impugnatura (vedere pag 180).

### 2. Rimuovere l'alloggiamento delle pipette

Ruotare di 90° le due chiusure del coperchio dell'alloggiamento delle pipette e rimuovere l'alloggiamento.

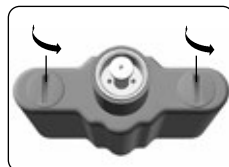

### 3. Rimuovere le viti

Rimuovere le due viti esterne a croce dall'asseme dei gambi.

**Attenzione:**

Non rimuovere l'asta centrale di guida (Z)!

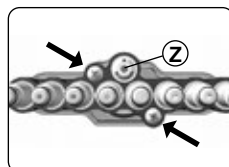

### 4. Separare i pistoni e l'unità di pipettaggio

Tirare e separare i pistoni e l'unità di pipettaggio.

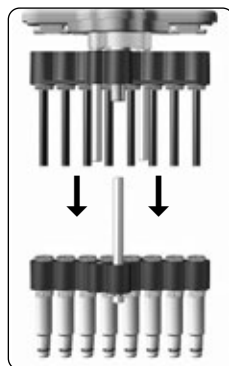

### 5. Togliere il pistone

Inserire la chiave per il montaggio sul dado del pistone e svitarlo. Togliere il dado del pistone ed estrarre il pistone.

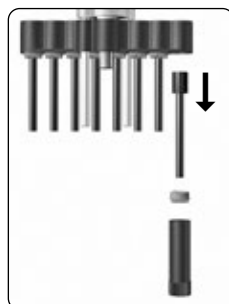



## 6. Inserire il pistone

Inserire un pistone pulito o nuovo e avvitare il dado con la chiave per il montaggio

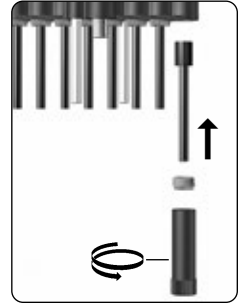

## 7. Rimontare pistoni e l'unità di pipettaggio

Allentare i gambi di mezzo giro. Infine inserire l'assieme dei gambi sull'assieme del pistone e bloccarlo. Poi avvitare i gambi.

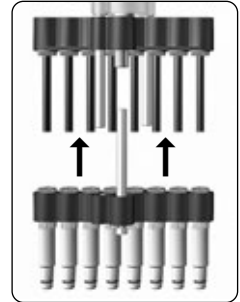

## 8. Riassemblare l'unità di pipettaggio

Riassemblare l'unità di pipettaggio e montarla sull'impugnatura.

### Nota:

L'unità di pipettaggio deve essere avvitata all'impugnatura in senso anti-orario finché si sente uno scatto.

Non tirare verso il basso l'unità di pipettaggio.

Verificare la tenuta, la scorrevolezza e la precisione dello strumento (vedere pagina 179 "Manutenzione").

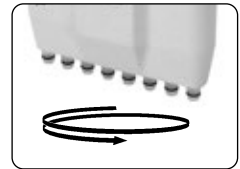

## 9. Eseguire il ciclo di riferimento

Eseguire il ciclo di riferimento (rEF).

## Ricarica e sostituzione dell'accumulatore

Un accumulatore completamente carico consente un pipettaggio continuativo per circa 8 ore con campioni con viscosità e densità analoga all'acqua.

### Attenzione!

Prima di eseguire la ricarica, controllare che l'alimentatore sia compatibile con la tensione disponibile in laboratorio. Non usare lo strumento in ambiente potenzialmente esplosivo. L'accumulatore può essere ricaricato solo nella Transferpette®-8/-12 electronic!

### Ricarica dell'accumulatore

- Inserire lo spinotto del cavo dell'alimentatore nell'apposita presa che si trova nella parte alta della Transferpette®-8/-12 electronic. La ricarica parte automaticamente.
- Durante la ricarica, le tacche dell'indicatore di carica dell'accumulatore si muovono continuamente dal basso verso l'alto. L'accumulatore è completamente carico quando le tacche dell'indicatore si fermano.



### Pipettare durante la ricarica dell'accumulatore?

Durante la ricarica si può continuare a lavorare con la Transferpette®-8/-12 electronic. Quando l'accumulatore è completamente scarico, bisogna attendere qualche minuto affinché venga raggiunto il livello minimo di carica richiesto per un funzionamento sicuro dello strumento.

**Nota:** Le ultime impostazioni dello strumento vengono memorizzate nella sua EEPROM. In caso di scarica completa o di sostituzione dell'accumulatore tali impostazioni sono quindi salvate!

### Sostituzione dell'accumulatore

- Aprire il vano, rimuovere l'accumulatore e sfilare il contatto dalla presa.
- Inserire il contatto del nuovo accumulatore nella presa e inserire il nuovo accumulatore.
- Reinserire il coperchio e chiudere il vano accumulatore.



Rimuovere l'accumulatore nel caso di un'interruzione prolungata dell'uso.

## Ricarica e sostituzione dell'accumulatore

### Visualizzazione della carica dopo la sostituzione dell'accumulatore

- a) Dopo la sostituzione dell'accumulatore appare **sul display l'indicazione della carica completa** con contorno lampeggiante (lo strumento non ha ancora rilevato il livello di carica). Dopo un tempo di ricarica di 3,5 ore – sicuramente sufficiente alla ricarica completa – il contorno smette di lampeggiare.



**Note:** Dopo aver inserito l'accumulatore, ricaricarlo per almeno 3,5 ore. La carica completa richiesta si raggiunge dopo vari cicli di carica/ scarica.

## Funzione di rigenera dell'accumulatore

### (funzione Refresh)

Per prolungare la durata dell'accumulatore e migliorarne le prestazioni, la Transferpette®-8/-12 electronic dispone di una funzione di rigenera dell'accumulatore (funzione Refresh). Questa funzione consiste nella ricarica e scarica completa dell'accumulatore, pilotata da software. Si consiglia di usare ogni tanto la funzione Refresh, per ottimizzare le prestazioni dell'accumulatore.

### Esecuzione della funzione Refresh

- a) Inserire lo spinotto del cavo dell'alimentatore nell'apposita presa che si trova nella parte alta della della Transferpette®-8/-12 electronic.



- b) Premere la freccia verso il basso per più di 3 sec. Durante la scarica le tacche dell'indicatore si muovono continuamente dall'alto verso il basso.



- c) Dopo la scarica (fino a 3 ore) inizia automaticamente la ricarica (3,5 ore). Durante la ricarica, le tacche dell'indicatore si muovono continuamente dal basso verso l'alto.









### Interruzione del funzione Refresh

Premendo un tasto qualsiasi il programma viene terminato. Lo strumento passa automaticamente alla modalità di pipettaggio standard (PIP), con volume nominale. Inizia automaticamente la ricarica normale (vedere pag. 184). Il programma termina anche quando si stacca lo spinotto dell'alimentatore. L'interruzione della funzione Refresh non deve essere eseguita alla fine del ciclo di scarico.

## Individuazione e soluzione dei problemi

In caso di errore, sul display viene visualizzato "Err" e il relativo codice dell'errore. A questo punto lo strumento risponde solo al tasto Enter. Quando viene premuto Enter lo strumento cerca di riavviarsi. Viene anche eseguito automaticamente un ciclo di riferimento.

Problema	Codice errore	Possibile causa	Soluzione
Lo strumento non risponde		Accumulatore scarico o difettoso	Ricaricare l'accumulatore per almeno 5 minuti senza usare lo strumento, poi riprendere il lavoro con alimentatore inserito fino alla completa ricarica, eventualmente sostituire l'accumulatore
		Componenti elettronici guasti	Inviare lo strumento alla riparazione
Lo strumento non risponde		Componenti elettronici guasti	Inviare lo strumento alla riparazione
Lo strumento non risponde		Errore imprevisto del programma	Premere il tasto Enter per resettare, lo strumento viene reinizializzato
Lo strumento non risponde		Componenti elettronici guasti	Inviare lo strumento alla riparazione
Nessuna indicazione sul display	—	Scarica elettrostatica	Rimuovere l'accumulatore e reinserirlo
		Componenti elettronici guasti	Inviare lo strumento alla riparazione
Il puntale gocciola/lo strumento perde o c'è un errore sul volume	—	Puntale non adatto	Usare solo puntali di qualità
		Il puntale non è inserito saldamente	Inserire a fondo il puntale
		Pistoni, gambo o la guarnizione è sporca o danneggiata	Pulire lo strumento/ sostituire la guarnizione Ingrassare pistone.
Il liquido non viene aspirato oppure si sente forte il rumore del motore	—	Scorrevolezza dei pistoni compromessa	Smontare l'unità di pipettaggio e muovere a mano la parte metallica intermedia

Marcatura	Signification
	Con questa sigla confermiamo che il prodotto soddisfa i requisiti definiti nelle direttive CE e che è stato sottoposto alle procedure di prova stabilite.
	Lo strumento è contrassegnato in conformità con la legislazione tedesca di misura e tarature, come previsto dal relativo regolamento: Indicazione DE-M (DE per Germania), incorniciata da un rettangolo, più le ultime due cifre dell'anno nel quale è stata effettuata la taratura (qui: 2020).
XXZXXXXX	Numero di serie
	Rispettare le indicazioni fornite sullo strumento, sugli accessori e nelle istruzioni per l'uso.
	Lo strumento o la batteria devono essere smaltiti in modo appropriato.
	Seguire le istruzioni per l'uso.
	L'etichetta EFUP (Environment Friendly Use Period - Periodo d'uso ecosostenibile) prevista dal regolamento cinese China RoHS (Restrictions of Hazardous Substances - Restrizioni sulle sostanze pericolose) definisce il periodo, espresso in anni, in cui le sostanze pericolose contenute nelle apparecchiature elettriche ed elettroniche, in presenza di normali condizioni di esercizio, non fuoriescono né subiscono mutazioni. In caso di normale utilizzo da parte dell'utente, tali prodotti elettrici ed elettronici non causano un grave inquinamento ambientale, né serie lesioni corporali o danni ai beni materiali dell'utente.
	Lo strumento elettrico non deve essere smaltito con i rifiuti domestici.

## Dati per l'ordinazione · Parti di ricambio

### Transferpette®-8 electronic con alimentatore (100-240V/50-60 Hz)

Volume	0,5-10 µl	1-20 µl	5-100 µl	10-200 µl	15-300 µl
	Codice	Codice	Codice	Codice	Codice
per Europa (continentale)	7053 99	7054 00	7054 03	7054 04	7054 06
per UK/Irlanda	7054 09	7054 10	7054 13	7054 14	7054 16
per USA/Giappone	7054 19	7054 20	7054 23	7054 24	7054 26
per Australia	7054 29	7054 30	7054 33	7054 34	7054 36

### Transferpette®-12 electronic con alimentatore (100-240V/50-60 Hz)

Volume	0,5-10 µl	1-20 µl	5-100 µl	10-200 µl	15-300 µl
	Codice	Codice	Codice	Codice	Codice
per Europa (continentale)	7054 49	7054 50	7054 53	7054 54	7054 56
per UK/Irlanda	7054 59	7054 60	7054 63	7054 64	7054 66
per USA/Giappone	7054 69	7054 70	7054 73	7054 74	7054 76
per Australia	7054 79	7054 80	7054 83	7054 84	7054 86

### Alimentatore (100-240V/50-60 Hz)

Descrizione	Codice
per Europa (continentale)	7053 50
per UK/Irlanda	7053 51
per USA/Giappone	7053 52
per Australia	7053 53

**Parti di ricambio Transferpette®-8/-12 electronic**

Forma e dimensioni delle parti di ricambio dipendono dal rispettivo volume nominale (fig. Parti di ricambio per Transferpette®-8/-12 electronic 5-100 µl).

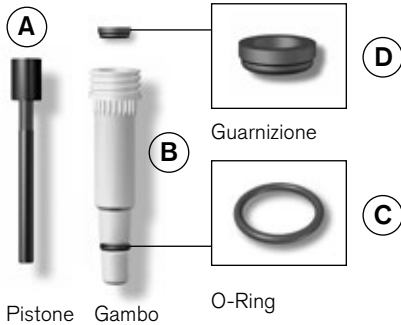

Volume	A	B*	C	D
0,5 - 10 µl	7056 59	7056 77	7033 80	7033 40
1 - 20 µl	7056 71	7056 78	7033 80	7033 41
5 - 100 µl	7056 62	7056 15	7056 18	7033 44
10 - 200 µl	7056 63	7056 16	7056 18	7033 45
15 - 300 µl	7056 64	7056 17	7056 18	7033 46

\* incl. guarnizione, O-Ring e chiave per il montaggio

**Puntali di qualità BRAND,**  
confezionati in rack, in TipBox

Volume	Numero di puntali	Codice
0,1 - 20 µl	480	7322 02
0,5 - 20 µl	480	7322 04
2 - 200 µl	480	7322 08
5 - 300 µl	480	7322 10

**Altri accessori**

Descrizione	Codice
Accumulatore di ricambio	7055 00
Grasso al silicone	7036 77
Grasso fluorato	7036 78
PLT unit	7039 70

### Invio al servizio riparazioni

**Attenzione!** La legge vieta il trasporto di merci pericolose senza autorizzazione.

- Perciò: pulire e decontaminare accuratamente lo strumento!
- Allegare al reso una descrizione precisa del tipo di problema e dei fluidi utilizzati. Se non si indicano i fluidi utilizzati, l'apparecchio non può essere riparato.
- La restituzione avviene a rischio e spese del mittente.

### Fuori di Stati Uniti e del Canada:

- Compilare la 'Dichiarazione di assenza di rischi per la salute' ed inviarla con lo strumento al distributore o al produttore. I moduli possono essere richiesti al distributore o al produttore, oppure si possono scaricare dal sito [www.brand.de](http://www.brand.de).

### Dentro di Stati Uniti e del Canada:

- Si invita a chiarire i requisiti per la restituzione con BrandTech Scientific, Inc. prima di inviare lo strumento al servizio di assistenza.
- Inviare solo strumenti puliti e decontaminati all'indirizzo ricevuto insieme al numero di reso. Applicare il numero di reso bene in vista sull'esterno del pacco.

### Indirizzi di contatto

#### BRAND GMBH + CO KG

Otto-Schott-Straße 25  
97877 Wertheim (Germany)  
Tel.: +49 9342 808-0  
Fax: +49 9342 808-98000  
E-Mail: [info@brand.de](mailto:info@brand.de)  
[www.brand.de](http://www.brand.de)

#### Stati Uniti e Canada:

BrandTech® Scientific, Inc.  
11 Bokum Road  
Essex, CT 06426-1506 (USA)  
Tel.: +1-860-767 2562  
Fax: +1-860-767 2563  
[www.brandtech.com](http://www.brandtech.com)

#### India:

BRAND Scientific Equipment Pvt. Ltd.  
303, 3rd Floor, 'C' Wing, Delphi  
Hiranandani Business Park, Powai  
Mumbai - 400 076 (India)  
Tel.: +91 22 42957790  
Fax: +91 22 42957791  
E-Mail: [info@brand.co.in](mailto:info@brand.co.in)  
[www.brand.co.in](http://www.brand.co.in)

#### Cina:

BRAND (Shanghai) Trading Co., Ltd.  
Guangqi Culture Plaza  
Room 506, Building B  
No. 2899, Xietu Road  
Shanghai 200030 (P.R. China)  
Tel.: +86 21 6422 2318  
Fax: +86 21 6422 2268  
E-Mail: [info@brand.cn.com](mailto:info@brand.cn.com)  
[www.brand.cn.com](http://www.brand.cn.com)



### Servizio Calibrazione

Le norme ISO 9001 e GLP prevedono la verifica periodica degli strumenti volumetrici. Consigliamo una verifica del volume ogni 3-12 mesi. Il ciclo delle verifiche dipende dalle esigenze individuali. In caso di uso frequente o di liquidi aggressivi sono opportune verifiche più frequenti. Le istruzioni dettagliate per la verifica possono essere scaricate da [www.brand.de](http://www.brand.de) o [www.brandtech.com](http://www.brandtech.com).

Inoltre, BRAND vi offre la possibilità di far tarare i vostri strumenti dal nostro Servizio calibrazione o dal Laboratorio DAkKs BRAND.

Inviateci semplicemente i vostri strumenti con le indicazioni del tipo di taratura richiesta. Dopo pochi giorni riceverete gli strumenti accompagnati da un certificato di prova (taratura di fabbrica) o da un certificato di taratura DAkKs. Per maggiori informazioni rivolgersi al proprio rivenditore specializzato o direttamente alla BRAND. La documentazione per l'ordinazione può essere scaricata dal sito [www.brand.de](http://www.brand.de) (documentazione tecnica).

## Garanzia

Non ci assumiamo alcuna responsabilità per le conseguenze di manipolazione, uso, manutenzione e impiego non corretti, o per riparazioni non autorizzate dello strumento o per le conseguenze del normale consumo, in particolare dei componenti soggetti ad usura, come ad esempio pistoni, guarnizioni e valvole, e in caso di rottura del vetro. Lo stesso vale per la mancata osservanza delle istruzioni per l'uso. In particolare non ci assumiamo alcuna responsabilità per danni derivanti da un ulteriore smontaggio dello strumento, al di là di quello previsto nelle istruzioni per l'uso, o se vengono montati accessori o parti di ricambio non originali.

Stati Uniti e Canada:

Per informazioni sulla garanzia consultare il sito [www.brandtech.com](http://www.brandtech.com).

## Smaltimento

---

Il simbolo accanto segnala che alla fine della loro vita utile le batterie/accumulatori e le apparecchiature elettroniche devono essere smaltite separatamente dai rifiuti domestici (rifiuti urbani misti).

- Gli strumenti elettronici devono essere smaltiti secondo quanto prescritto dalla direttiva del parlamento europeo 2002/96/CE e del consiglio del 27 gennaio 2003 e dalla normativa nazionale vigente in materia di smaltimento di rifiuti di apparecchiature elettriche ed elettroniche.
- Le batterie/accumulatori contengono sostanze che possono avere effetti nocivi per l'ambiente e per la salute delle persone. Devono essere smaltiti secondo quanto prescritto dalla direttiva del parlamento europeo 2006/66/CE e del consiglio del 06 settembre 2006 e dalla normativa nazionale vigente in materia di smaltimento di rifiuti di batterie e accumulatori. Smaltire solo batterie e accumulatori completamente scarichi.

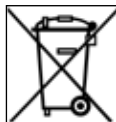

**Attenzione!** Non cortocircuitare batterie e l'accumulatore per scaricarlo!

	页码
安全说明	194
功能与使用限制	195
禁止操作	195
<b>操作元件</b>	<b>196</b>
第一步	197
设定体积	198
设定吸液与排液速度	199
正确移液	200
移液程序	201
移液 (PIP 模式)	202
样品混合(PIPmix模式)	204
反相移液(revPIP模式)	206
电泳上样(GEL模式)	208
连续分液(DISP模式)	210
检查体积	212
准确度表	213
<b>易校准 (调整)</b>	<b>214</b>
灭菌	216
参考运行 ( rEF)	216
保养与清洁	217
电池充电与更换电池	222
电池再生功能	223
故障诊断	224
在设备上标记	225
订购信息·附件·零部件	226
维修和·联系地址	228
校准服务·担保信息	229
丢弃	230

## 安全说明

该设备可能与有害的物质、操作和设备一起使用。本手册不可能提示这些应用中所有的潜在安全风险。用户有责任在使用前咨询并建立恰当的安全与健康规程，并决定规章限制的适用性。

### 请仔细阅读下列说明！

1. 所有使用者在使用该设备之前必须阅读并理解本操作手册，并在使用过程中遵守这些说明。
2. 遵循有害防护与安全指导的通用规章；比如，穿着防护服，佩戴防护镜与手套。当操作具有感染性或者有危害的样品时，须遵守所有适用规章并采取预防措施。
3. 请遵守试剂供应商提供的所有安全注意事项。
4. 绝不可以有在爆炸危险的环境中使用本仪器。不可移取易燃液体。
5. 本仪器仅可用于液体移取，所移液体需严格符合“禁止操作”与“操作限制”的规定（参见第195页）。如有疑问，请联系厂方或者供应商。
6. 请始终以对用户及他人均安全的方式进行操作。仅将样品分配至合适的容器内，防止飞溅。
7. 操作危险样品时请避免接触吸头吸嘴。
8. 操作时请勿过度用力。
9. 请仅使用原厂配件。切勿试图对本仪器进行任何技术改造。不要对本仪器进行超过操作手册描述范围的拆卸。
10. 使用前请检查仪器有无可见损伤。如果仪器在操作时有潜在的故障迹象（比如，活塞移动困难，泄漏），请立即停止移液。咨询本手册的“故障诊断”（参见224页），有必要的话请联系供应商。
11. 请勿使用其他不可充电或者可充电电池替换原装电池。
12. 为镍氢电池充电，请仅适用原装AC电源适配器。
13. AC电源适配器须防止受潮。仅可使用在本设备上。
14. 仅可在电池完全放电后对电池进行处置。请遵守当地相关处置规定。

### 警告！

该仪器或电池使用不当（短路、机械损坏、过热，错误的AC电源适配器等）在极端情况下可能会导致电池爆炸。

Transferpette® -8/-12 electronic 八/十二通道电子移液器是一款微处理器控制、电池驱动活塞的多通道移液器，采用空气活塞式原理，用于移取一般密度和粘度的水相溶液。

在正确操作过程中，样品仅与吸头接触，不会与 Transferpette® -8/-12 electronic 接触。

#### 使用限制

Transferpette®-8/-12 electronic 设计用于在下列使用限制范围内的移液操作：

- 设备和溶液的温度应为 15 °C~40 °C (59 °F ~104 °F)。若使用的温度不在此范围内，请咨询供应商。
- 蒸汽压小于 500 mbar
- 黏度：260 mPa s (260 cps)

#### 禁止操作

用户有责任确认该设备与拓展应用的兼容性。

请勿将该装置用于会与聚丙烯，聚偏氟乙烯和硅胶（PP：吸头与吸头锥）或聚碳酸酯/聚对苯二甲酸丁酯（PC / PBT：握柄）反应的液体。防止产生反应性蒸汽（腐蚀危险）。

握柄部位不可灭菌。

#### 操作限制

粘稠或高粘性的液体可能会导致体积失准。移液的准确度同样可能受到温度的影响（当液体温度与室温的温差大于  $\pm 5$  °C / 41 °F）。

#### 电池和AC电源适配器规格

##### 电池

镍氢电池，带三块AAA柱状独立电池。  
3.6 V, 700 mAh

##### AC电源适配器

输出电压 6.5 V DC, 200 mA

# 操作元件

Transferpette® -8/-12 electronic 八/十二通道电子移液器是一款微处理器控制、电池驱动活塞的多通道移液器，根据人体工程学进行优化，简便易用。

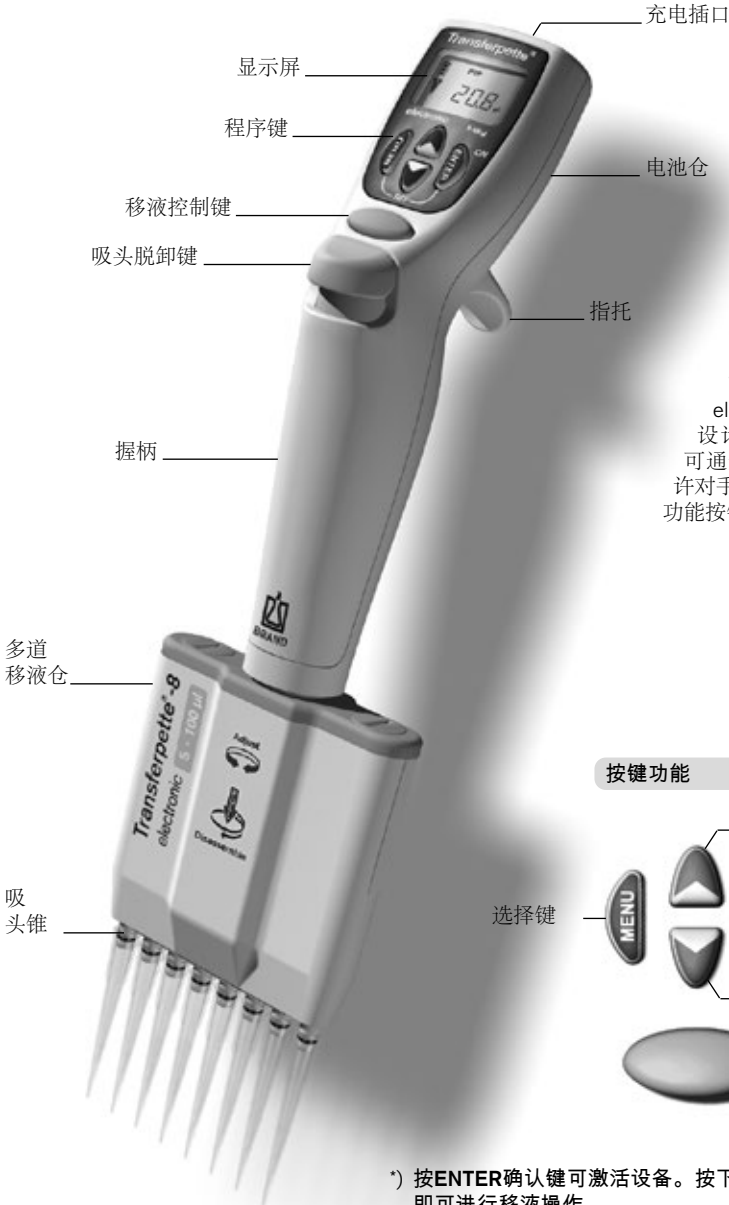

Transferpette® -8/-12 electronic 采用人体工程学设计，操作舒适。指托高度可通过一颗螺丝调节，从而允许对手的姿势进行微调，使操作功能按钮更轻松。

## 按键功能

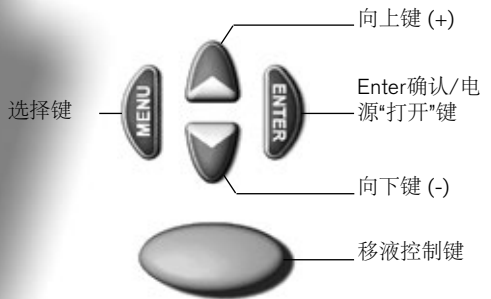

\*) 按ENTER确认键可激活设备。按下下面的移液控制键之后，即可进行移液操作。

Transferpette® -8/-12 electronic 在 10 分钟无操作情况下将自动关机 (Auto-Power-Off)。

### 核对包装内容

确认您的产品包装中包括：Transferpette®-8 或 -12 通道电子移液器、电池、带电池充电接线的电源适配器、移液器架一个、加样槽一个、硅脂、操作手册和 1 套 硅胶材质的 O 形环。

### 第一次使用 Transferpette®-8/-12 electronic

#### 1. 插入电池

- a) 打开电池仓盖。
- b) 确保电池上的插头与移液器的插座牢固连接。放入电池。
- c) 盖上电池仓盖。



#### 2. 激活设备

插入电池后，Transferpette®-8/-12 electronic 会自动要求进行参考运行。按下移液控制键之后，进行参考运行，然后可以进行移液操作。

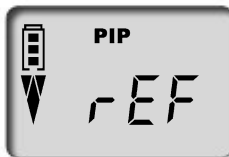
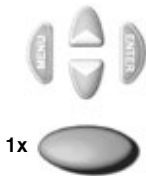

显示屏显示标准出厂设置 (移液模式/PIP) 和标称量程 (例如 100.0 µl)。默认的吸液和排液速度为最大值。量程和速度的调节将在下面内容中描述。

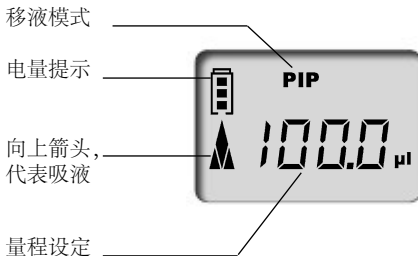

# 设定体积

Transferpette® -8/-12 electronic的出厂量程设置为标称量程，可以快速方便地进行更改。

操作步骤	操作方法	操作按钮	屏幕显示
1. 激活量程设定	按任意一个箭头键，激活量程选择功能。“VOL”图标闪烁。		
2. 改变体积	减少体积 按向下箭头键 (-) 减少体积。 按住箭头键不放可以加快更改速度。“VOL”图标继续闪烁。		
	增加体积 按向上箭头键 (+) 增加体积。 按住箭头键不放可以加快更改速度。“VOL”图标继续闪烁。		
3. 确认体积设定	按 ENTER 确认键。显示屏将显示新的体积，在这里，PIP 模式下为 102.8 µl。		

## 重要提示：

按MENU菜单键可取消任何步骤！接着显示屏进入下一设置或返回至初始屏幕(取决于实际进行的选择)。



吸液和排液速度可单独调节。调出菜单之后，将显示上次速度的设置。有五个速度级别可供选择。

操作步骤	操作方法	操作按钮	屏幕显示
<b>设定吸液速度</b>			
1. 调出菜单	按 MENU 菜单键一次，可调出吸液速度菜单。“Speed”速度图标闪烁。	 1x	
2. 更改吸液速度	按箭头键 (+/-) 选择需要的速度 (这个例子里选的是，第五档)。“Speed”速度图标继续闪烁。	 + -	
3. 确认速度设置	按 ENTER 确认键。显示返回当前模式 (这个例子中为标准 PIP 移液模式)。	 1x	
<b>设定排液速度</b>			
1. 调出菜单	按 MENU 菜单键两次，可调出排液速度菜单。“Speed”速度图标闪烁。	 2x	
2. 更改排液速度	按箭头键 (+/-) 选择需要的速度 (这个例子里选的是，第二档)。“Speed”速度图标继续闪烁。	 + -	
3. 确认速度设置	按 ENTER 确认键。显示返回当前模式 (这个例子中为标准 PIP 移液模式)。	 1x	

Transferpette®-8/-12 electronic 的出厂量程设置为标称量程，可以快速方便地进行更改。参见第 198 页。

### 在标准移液模式下快速启动

#### 1. 安装吸头

请根据量程范围或颜色标识使用正确规格的吸头。确保牢固安装吸头。吸头为一次性物品！

#### 2. 对齐多道移液仓

多通道移液仓可双向自由转动。

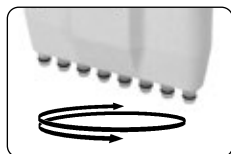

#### 3. 吸取液体

垂直握持移液器并将吸头浸入液体2-3mm。



按移液控制键将液体吸入吸头。显示屏上的向上的箭头，指示正处于吸液状态。



**提示：** 将吸头继续保持浸入液体约 1s，以防止吸入空气。

#### 4. 排出液体

吸液之后，显示屏上的箭头向下，指示进入排液状态。

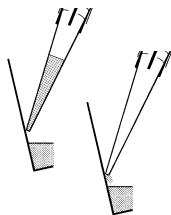

手握移液器呈 30-45° 的角度，将吸头贴在容器壁上。

再次按移液控制键将液体完全排出，吹出为自动执行。将吸头贴在容器壁上擦去残液。



#### 5. 退除吸头

手持移液器，将多道移液仓悬空置于合适的处置容器上方，然后按吸头脱卸键。

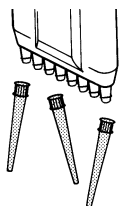

吸头脱卸键



**提示：**

依据ISO 8655，在实际进行移液过程之前，应用样品液体润洗一次吸头。

1. 标准移液  
**PIP**模式 \_\_\_\_\_ **202**  
标准程序。移液器吸取之前设定体积的液体，然后排出液体。
  
2. 样品混合  
**PIPMix**模式 \_\_\_\_\_ **204**  
该程序可完成样品混合操作。反复吸取和排出样品。
  
3. 反相移液  
**revPIP**模式 \_\_\_\_\_ **206**  
专为移取高黏度、高蒸汽压或易发泡液体所设计的程序。
  
4. 凝胶电泳上样  
**GEL**模式 \_\_\_\_\_ **208**  
该程序模式可用于凝胶电泳上样。以较高的可调速度吸取预定义体积的样品，然后缓慢排出样品。
  
5. 连续分液  
**DISP**模式 \_\_\_\_\_ **210**  
连续等分移液的程序。可将所吸取的液体分次排出。

标准程序。移液器吸取之前设定体积的液体，然后排出液体。  
体积和速度调整参见第 198 和 199 页。

操作步骤	操作方法	操作按钮	屏幕显示
1. 调出菜单	按MENU菜单键三次，可调出模式选择菜单。“Mode”模式图标闪烁。	3x 	
2. 选择PIP模式	使用任意一个箭头键滚动模式菜单，直至“PIP”选项出现。“Mode”模式图标继续闪烁。		
3. 确认PIP模式	按ENTER 确认键。 显示屏将显示“blo”吹出，指示进行吹出操作。	 1x	
4. 准备移液	按移液控制键，执行吹出动作（移液器在任何程序确认后都自动要求执行吹出，确保吸头中没有上轮操作的残液），活塞移动至起始位置。显示屏上的箭头显示向上（吸液）。	 1x	
5. 吸取液体	按移液控制键吸取液体。	 1x	

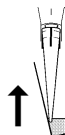

操作步骤	操作方法	操作按钮	屏幕显示
------	------	------	------

## 6. 排出液体

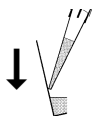

按移液控制键排出液体。显示屏上的箭头在吸取完液体后指示自动转为向下(排液)。

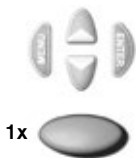

## 7. 吹出？

无需进行操作！  
在PIP模式下进行移液时，  
将自动执行吹出功能。



## 手动调出吹出功能

如有必要，可随时手动调出吹出功能。

## 1. 调出吹出功能

按ENTER（回车）键。显示屏将显示“blo”吹出。

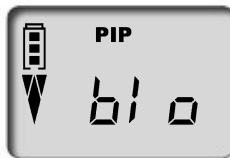

## 2. 进行吹出

按移液控制键进行吹出。执行完毕后显示屏将返回至选定移液模式的初始界面。

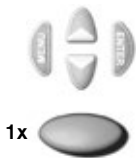

## 提示：

执行吹出时，移液器活塞将移动至最低位置。使用者必须确保安全排出所有残留液体。

若按住移液控制键不放，活塞将保持在最低位置，从而可避免意外吸入液体。释放此键，活塞将返回至起始位置。

该程序可完成样品混合操作。反复吸取和排出样品。  
体积和速度调整参见第 198 和 199 页。

操作步骤	操作方法	操作按钮	屏幕显示
1. 调出菜单	按 MENU 菜单键三次，可调出模式选择菜单。“Mode”模式图标闪烁。	3x	
2. 选择 PIPmix模式	使用任意一个箭头键滚动模式菜单，直至“PIP”选项出现。“Mode”模式图标继续闪烁。		
3. 确认 PIPmix模式	按 ENTER 确认键。 显示屏将显示“blo”吹出，指示进行吹出操作。		
4. 准备移液	按移液控制键，执行吹出动作（移液器在任何程序确认后都自动要求执行吹出，确保吸头中没有上轮操作的残液），活塞移动至起始位置。显示屏上的箭头显示向上（吸液）。		
5. 吸取液体	按移液控制键吸取液体。		

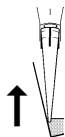

操作步骤	操作方法	操作按钮	屏幕显示
<p>6. 在PIPmix模式下排液</p> 	<p>按住移液控制键不放，即可吸取或排出液体。显示屏显示向上箭头表示吸液，向下箭头表示排液，并显示吸排液的轮数。</p>	 <p>按住移液控制键不放</p>	
<p>7. 结束移液</p>	<p>按移液控制键，将排出液体并启动吹出功能。 排出残留液体（吹出）之后，显示将返回至起始界面。</p>	 <p>1x</p>	



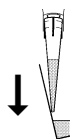
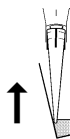

**提示：** 显示屏可显示的吸排液的轮数最多为19轮。

专为移取高黏度、高蒸汽压或易发泡液体所设计的程序。  
体积和速度调整参见第 198 和 199 页。

操作步骤	操作方法	操作按钮	屏幕显示
1. 调出菜单	按 MENU 菜单键三次，可调出模式选择菜单。“Mode”模式图标闪烁。	3x	
2. 选择revPIP模式	使用任意一个箭头键滚动模式菜单，直至“revPIP”选项出现。“Mode”模式图标继续闪烁。		
3. 确认revPIP模式	按 ENTER 确认键。 显示屏将显示“blo”吹出，指示进行吹出操作。	1x	
4. 准备移液	按移液控制键，执行吹出动作（移液器在任何程序确认后都自动要求执行吹出，确保吸头中没有上轮操作的残液），活塞移动至起始位置。显示屏上的箭头显示向上（吸液）。	1x	
5. 吸取液体	按移液控制键吸取液体。所吸取的液体体积将会比设定体积稍多。	1x	
6. 在revPIP模式下排液	如需排出设定量的液体，按移液控制键。显示屏上的箭头在吸取完液体后指示自动转为向下（排液）。部分残余液体将留在吸头内。	1x	

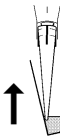
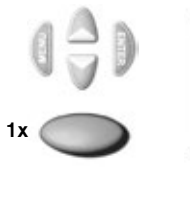

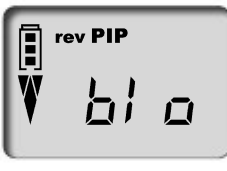
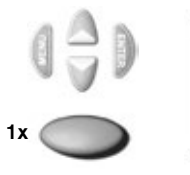
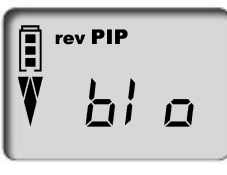

操作步骤	操作方法	操作按钮	屏幕显示
<p>7. 在revPIP模式下重复吸液</p> 	<p>再次按移液控制键，设定体积的液体将被吸入吸头。之后再次按移液控制键，此体积的液体将被再次排出，以此循环…</p>		
<p>8. 启动吹出功能</p>	<p>在最后一次移液操作之后按ENTER（回车）键。显示屏将显示“blo”吹出。</p>		
	<p>按移液控制键执行吹出。残留液体被排出。</p>		
<p>9. 结束移液</p>	<p>排出残留液体（吹出）之后，显示将返回至起始界面。</p>		

该程序模式可用于凝胶电泳上样。以较高的可调速度吸取预定义体积的样品，然后缓慢排出样品。体积和速度调整参见第 198 和 199 页。

操作步骤	操作方法	操作按钮	屏幕显示
1. 调出菜单	按 MENU 菜单键三次，可调出模式选择菜单。“Mode”模式图标闪烁。	3x	
2. 选择GEL模式	使用任意一个箭头键滚动模式菜单，直至“GEL”选项出现。“Mode”模式图标继续闪烁。		
3. 确认GEL模式	按 ENTER 确认键。显示屏将显示“blo”吹出，指示进行吹出操作。	1x	
4. 准备移液	按移液控制键，执行吹出动作（移液器在任何程序确认后都自动要求执行吹出，确保吸头中没有上轮操作的残液），活塞移动至起始位置。显示屏上的箭头显示向上（吸液）。	1x	
5. 吸取液体	按移液控制键。设定体积的液体将被吸入吸头。		
	<b>吸取超量的液体</b> 如需吸取比设定体积多的液体（最多为标称量程的 110%），按住移液控制键，直至吸取了所需体积的液体。显示屏在吸液时显示一个菱形图标。		

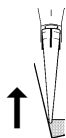

按住移液控制键不放

操作步骤	操作方法	操作按钮	屏幕显示
6. 在GEL模式下排液	按移液控制键排液。显示屏此时显示一个菱形图标。液体被非常缓慢地排出。		
	中断排液 如需中断排液，再次按移液控制键。显示屏显示已排出体积。		
7. 启动吹出功能	在最后一次移液操作之后按ENTER确认键。显示屏将显示“blo”吹出。		
	按移液控制键执行吹出。残留液体被排出。		
8. 结束移液	排出残留液体（吹出）之后，显示将返回至起始界面。		

**提示：**

在GEL模式下，排液速度非常缓慢，以防止样品产生涡流。为确保达到最佳的凝胶上样效果，GEL模式的排液速度为固定值。此速度远远小于1档速度设定，并且不可单独进行选择。

连续等分移液的程序。可将所吸取的液体分次排出。  
速度调整参见第 199 页。

操作步骤	操作方法	操作按钮	屏幕显示
1. 调出菜单	按 MENU 菜单键三次, 可调出模式选择菜单。“Mode”模式图标闪烁。	3x 	
2. 选择DISP模式	使用任意一个箭头键滚动模式菜单, 直至“DISP”选项出现。“Mode”模式图标继续闪烁。		
3. 确认DISP模式	按 ENTER 确认键。显示屏将显示“blo”吹出, 指示进行吹出操作。	 1x	
4. 准备分液	按移液控制键, 执行吹出动作 (移液器在任何程序确认后都自动要求执行吹出, 确保吸头中没有上轮操作的残液), 活塞移动至起始位置。显示屏上的箭头显示向上 (吸液)。	 1x	
5. 设定单次分液体积	按箭头键 (+/-) 设定体积。按住箭头键不放可以加快更改速度。“VOL”闪烁。		
6. 确认单次分液体积	按 ENTER 确认键。显示屏将显示单次分液体积设置和最大排液次数。“Steps”次数图标闪烁。	 1x	

操作步骤	操作方法	操作按钮	屏幕显示
7. 设定分液次数	按箭头键 (+/-) 设定分液次数。“Steps”次数图标继续闪烁。		
8. 确认分液次数	按 ENTER 确认键。显示屏将显示设定的分液次数。		
9. 吸取液体	按移液控制键吸取液体。		
10. 连续分配液体	每按一次移液控制键，将执行一次分液。显示屏上的箭头向下（排液）。显示屏显示剩余的分液次数。		
11. 启动吹出功能	在最后一次移液操作之后按 ENTER 确认键。显示屏将显示“blo”吹出。 按移液控制键执行吹出。残留液体被排出。（也可参见209页）		
12. 结束移液	排出残留液体（吹出）之后，显示将返回至起始界面。		

# 检查体积

根据使用情况，建议每3至12个月对移液器进行一次校准。根据具体情况可对检查周期时间进行调整。

依据DIN EN ISO 8655第6部分，使用重力法按下列步骤对移液器进行测试。

## 1. 设定标称量程

将体积设定为移液器的最大量程。  
操作步骤参见第198页。

## 2. 调整移液器状态

在测试之前，安装一个移液器吸头，并用测试液体（蒸馏水）进行五次吸液和排液操作。然后弃置该吸头。

## 3. 执行测试

- a) 安装一个新的吸头，并用测试液体吸液一次润洗吸头。
- b) 吸取测试液体，并将其移取至称量容器内。

**提示** 必须对各通道进行单独测试。

- c) 用分析天平称量所移取液体。  
请遵守天平制造商的操作说明。
- d) 在考虑温度条件的情况下计算体积。
- e) 建议每个通道在三个量程段（标称量程的100%、50%、10%体积）进行3-10次移液和称量操作，以便进行统计分析。

### 计算（标称量程）

$x_i$  = 称量结果  
 $n$  = 称量次数

$Z$  = 校正因子  
(例如 1.0029  $\mu\text{l}/\text{mg}$  (20 °C, 1013 hPa))

平均值  $\bar{x} = \frac{\sum x_i}{n}$

平均体积  $\bar{V} = \bar{x} \cdot Z$

### 准确度\*

$$R\% = \frac{\bar{V} - V_0}{V_0} \cdot 100$$

$V_0$  = 标称量程

### 标准偏差

$$s = Z \cdot \sqrt{\frac{\sum (x_i - \bar{x})^2}{n - 1}}$$

### 偏差系数\*

$$VK\% = \frac{100 s}{\bar{V}}$$

\*) = 计算准确度 (A%) 和偏差系数 (CV%)  
A % 和 CV % 的计算依据统计学公式。

根据DIN EN ISO 8655 要求。标称（额定）量程（即仪器的最大量程）与分段量程，使用蒸馏水在 20 °C，平顺稳定地操作测得的误差极限。

CE



20 °C  
Ex

## Transferpette®-8/-12 electronic 精度误差范围

量程范围 µl	体积 µl	A* ≤ ± %	CV* ≤ %	增量 (分刻度) µl	建议吸头类型 µl
0.5 - 10	10	1.2	0.8	0.01	0.5 - 20
	5	2.0	1.5		
	1	8.0	4.0		
1 - 20	20	1.0	0.5	0.02	0.5 - 20
	10	2.0	1.0		
	2	8.0	3.0		
5 - 100	100	0.8	0.25	0.1	2 - 200
	50	1.6	0.4		
	10	4.0	1.5		
10 - 200	200	0.8	0.25	0.2	2 - 200
	100	1.4	0.4		
	20	4.0	1.3		
15 - 300	300	0.6	0.25	0.5	5 - 300
	150	1.2	0.4		
	30	3.0	1.2		

\* A = 准确度, CV = 偏差系数

### 提示

测试指南 (SOP) 和 EASYCAL™ 4.0 校准软件的试用版可在 [www.brand.de](http://www.brand.de) 上下载。

校准模式，“CAL”

## 调整

在标准移液 (PIP) 模式下，将移液器设定为标称量程（例如标称量程为 100  $\mu\text{l}$  的移液器设置为 100  $\mu\text{l}$ ）或者特定的测试体积。操作步骤见第 198 与 202 页。假设：在标称量程时实测体积为 101.3  $\mu\text{l}$ 。



## 操作步骤

## 操作方法

## 操作按钮

## 屏幕显示

## 1. 调出CAL模式

按住 MENU 菜单键 (> 3 s)，直至“CAL”图标出现。显示屏显示“off”关闭字样。“CAL”图标闪烁。



## 2. 激活CAL模式

按任意一个箭头键，激活 CAL 模式。显示由“off”关闭变为“on”开启。“CAL”图标继续闪烁。

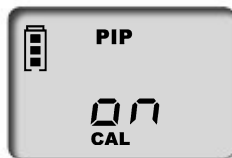

## 3. 确认CAL模式

按 ENTER 确认键。显示设定体积界面。“CAL”图标继续闪烁。



## 4. 设定体积

按箭头键 (+/-) 调至实测体积。“CAL”继续闪烁。



## 5. 确认体积

按 ENTER 确认键。显示屏显示校准后的测试体积。“CAL”固定显示在下方表示移液器进行过调整。





## 恢复出厂默认设置

“CAL”固定显示表示移液器进行过调整。

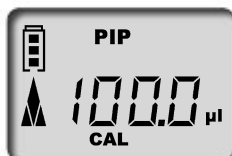

## 操作步骤

## 操作方法

## 操作按钮

## 屏幕显示

## 1. 调出CAL模式

按住 MENU 菜单键(> 3 s), 直至“CAL”图标出现。显示屏显示“ON”开启字样。“CAL”图标闪烁。

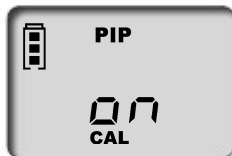

## 2. 关闭CAL模式

按任意一个箭头键。显示由“on”开启变为“off”关闭。“CAL”图标继续闪烁。



## 3. 恢复出厂默认设置

按 ENTER 确认键。CAL图标消失。现在，移液器量程已恢复至出厂默认设置。



## 重要提示:

对 Transferpette® -8/-12 electronic 进行调整时, 进行了体积补偿, 这意味着移液器整个量程范围内的体积均发生了相同量的变化。建议在标称量程的 50 % 体积下进行调整。

## 提示:

该移液器设置为适用于水溶液, 但也可设定适合不同密度、粘度和温度的溶液。除 GEL 模式外, 可在任何模式下对 Transferpette® -8/-12 electronic 进行调整。

# 灭菌

依据 DIN EN 285，可在 121 °C (250 °F)、2 bar (30 psi) 条件下对 Transferpette® -8/-12 electronic 的多道移液仓 (P) (图中高亮部分) 进行至少 15 分钟的高温高压湿热灭菌。

**注意：** 握柄部分不可高温灭菌！

1. 退掉吸头。
2. 将多道移液仓从握柄上旋下 (见第 218 页)。
3. 对整个多道移液仓 (无需进一步拆卸) 进行高温高压灭菌。
4. 等待多道移液仓完全冷却并干燥。
5. 将多道移液仓旋入手柄 (见第 218 页)。
6. 执行参考运行 (rEF)。

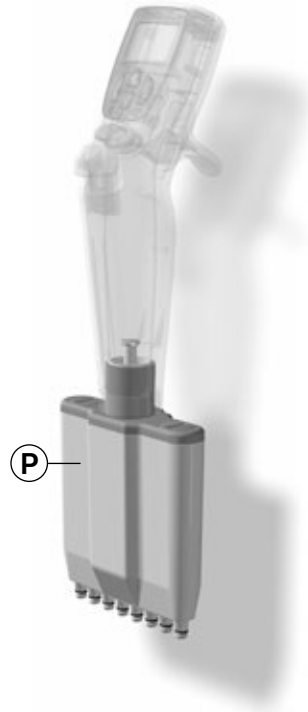

**提示：** 灭菌效果须由使用者判断。  
采用真空灭菌最可靠。建议使用灭菌袋。

若经常对多道移液仓进行高温高压灭菌，应使用随附的硅油润滑活塞，以使其移动顺滑。



## 参考运行 (rEF)

每次将多道移液仓重新装上握柄之后，必须进行手动参考运行。参考运行可确保活塞牢固连接。

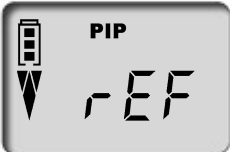
操作步骤	操作方法	操作按钮	屏幕显示
1. 调出rEF模式	同时按 MENU 菜单和 ENTER 确认键激活 rEF 模式。		
2. 执行参考运行	按移液控制键执行参考运行。可以听到运行的声音，指示该功能正在进行。		

**提示：** 参考运行之后，将自动返回上一程序的显示界面。

多道移液仓的三个主要组件可以很方便地拆卸，以便保养、清洁或更换部件。操作步骤如图中所示。

**提示：** 有关更换单个吸头锥上的V形环（O形环）的详细描述，请参见零备件随附的说明书。

## 多道分液仓的主要组件 (P)

- A 活塞单元**，包括活塞支架 [ I ] 和插入此单元的活塞，可单独旋下来进行清洁或更换。
- B 吸头锥单元**，包括吸头锥支架 [ II ] 和与其相连的中央导杆 (Z)，以及吸头锥和密封圈，可单独旋下来进行清洁或更换。
- C 多道移液仓外壳**，通过两个转锁紧固件连接至活塞单元的多道移液仓外壳盖 [ III ]。

## 保养

为确保功能正常，请定期保养和清洁 Transferpette® -8/ -12 electronic。

## 检查内容

1. 检查吸头锥、活塞和密封圈是否被损坏和污染。
2. 测试移液器的密封性。我们推荐使用 BRAND 移液器泄漏检测仪 PLT 进行测试。  
替代方法：吸入样品，然后垂直手持移液器保持约 10 s。若在吸头吸嘴有液滴形成，请参阅第 224 页的“故障诊断”。

## 清洁说明 (218-221 页)

1. 用肥皂液或异丙醇清洗各吸头锥、活塞和吸头锥支架/活塞支架（仅限这些组件）。然后用蒸馏水冲洗。
2. 等待组件完全干燥与冷却。吸头锥内残留的湿气会导致准确度降低。
3. 为活塞涂上薄薄一层随附的硅油。推荐仅使用氟性全合成特种（润滑）脂润滑中央导杆 (Z)！
4. 组装之后，执行参考运行 (rEF)。

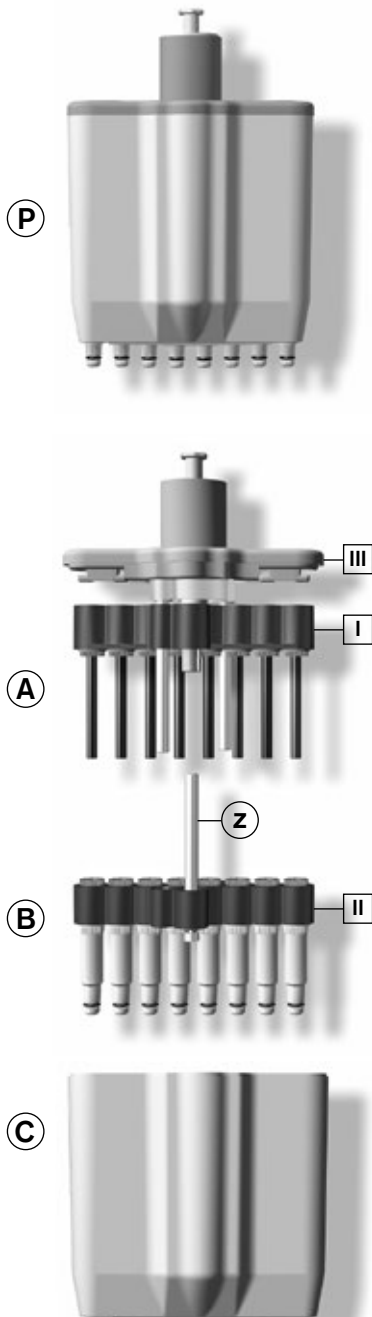

## 保养与清洁

### 从多道移液仓上卸下握柄

1. 退掉吸头。
2. 将多道移液仓其向下拉到底断开多道移液仓与握柄的内部连接，然后顺时针转动。  
转动一圈之后，在转动过程中不用再向下拉。
3. 旋开多道分液仓之后，再次将其向下拉，以断开磁力耦合。

#### 提示：

必须逆时针将多道移液仓旋入握柄，直至听到卡入位的咔哒声。  
安装多道移液仓时不得将其向下拉。

#### 注意：

操作不当会损坏仪器！



### 取下吸头锥和密封圈进行清洁或更换

1. 旋下多道移液仓 将多道移液仓从握柄上旋下。

2. 打开外壳 将移液仓外壳盖上的两个转锁转动90°，将仓壳褪下。

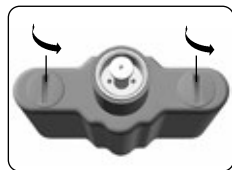

3. 旋下吸头锥 将安装工具套住吸头锥，将吸头锥旋下。

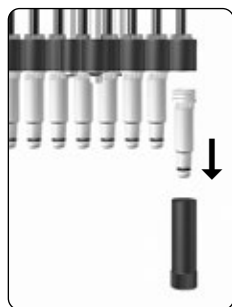

#### 4. 取下密封圈

将活塞单元向下推到底。取下密封圈，进行检查和清洁，如有必要，更换新的密封圈。

**提示：**

密封圈可能位于吸头锥内部，或者在取下吸头锥之后套在活塞上。

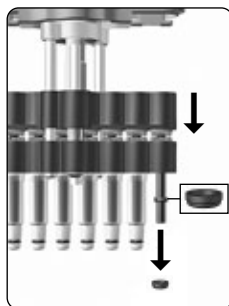

#### 5. 安装密封圈

如有必要，请使用随附的硅脂润滑活塞。将密封圈平面朝上推至活塞上。使用安装工具安装并拧紧经过清洁或者新的吸头锥

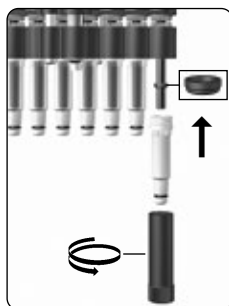

#### 6. 重新组装多道移液仓

重新组装多道移液仓，并将其安装至握柄上

**提示：**

必须逆时针将多道移液仓旋入握柄，直至听到卡入位的咔哒声。安装多道移液仓时不得将其向下拉。

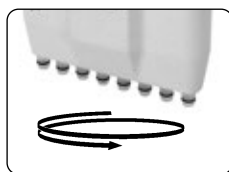

检查移液器气密性、活动性和准确性（参见 217 页“保养”）。

#### 7. 执行参考运行

执行参考运行（rEF）。

## 取下活塞进行清洁或更换

1. 旋下多道移液仓 将多道移液仓从握柄上旋下。（参见 218 页）

2. 打开外壳 将移液仓外壳盖上的两个转锁转动 90°，将仓壳褪下。

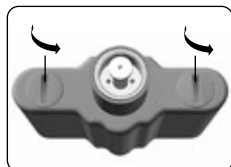

3. 旋下螺丝 取下吸头锥单元上的两个外部Phillips螺丝。

**注意：**

请勿拧松中央导杆（Z）

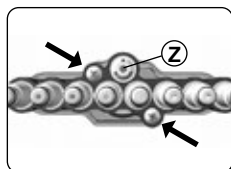

4. 将活塞与吸头锥单元分开 将活塞与吸头锥单元分开。

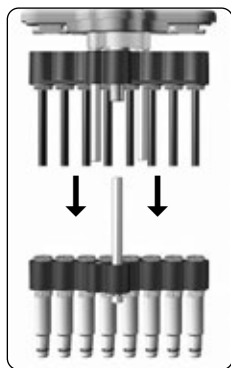

5. 取下活塞 将安装工具套在活塞螺帽上并拧松活塞螺帽。取下活塞螺帽，拔出活塞。

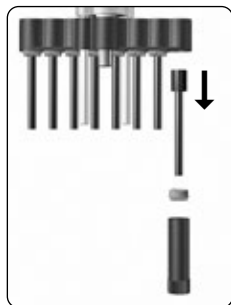

## 6. 安装活塞

将经过清洁的或者新的活塞插入。将活塞螺帽旋上，并用安装工具紧固。

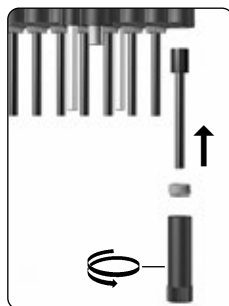

## 7. 重新组装活塞与吸头锥单元

将吸头锥旋半圈旋松。然后将吸头锥单元推上活塞单元，并上紧螺丝。接着，旋紧吸头锥。

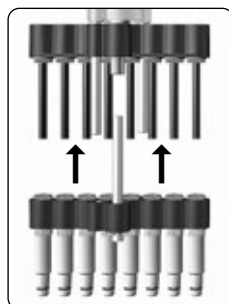

## 8. 安装多道移液仓

重新组装多道移液仓，并将其安装在握柄上。

### 提示：

必须逆时针将多道移液仓旋入握柄，直至听到卡入位的咔哒声。  
安装多道移液仓时不得将其向下拉。

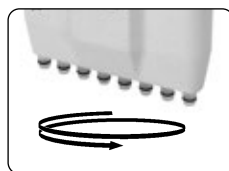

检查移液器气密性、活动性和准确性（参见217页"保养"）。

## 9. 执行参考运行

执行参考运行 (rEF)。

## 电池充电与更换电池

充满电的电池可连续使用约8小时 (所移取液体的粘度和密度接近于水)。

### 重要提示！

充电之前，请确保AC电源适配器与实验室的电压相符合。请勿在有爆炸风险的环境下充电。仅可在 Transferpette®-8/-12 electronic 内为电池充电。

### 电池充电

- 将AC电源适配器的充电插头插入Transferpette®-8/-12 electronic 顶部的插口；充电将自动开始。
- 充电过程中，电量指示进度条将从底部到顶部反复变化。电池充满电时，显示屏上的电量指示将停止运动。



### 充电过程中进行移液？

充电过程中，您可以继续使用 Transferpette®-8/-12 electronic。若电池完全放电，在达到安全操作需要的最小电量之前会有几分钟时间无法操作。

**提示：** 最后一次操作的设置储存在移液器的存储器内。即便电池完全放电或者更换电池之后，这些设置仍然保存着。

### 更换电池

- 打开电池仓盖。取出电池，将电池插头从插座中小心拔出。
- 将新电池上的插头与移液器的插座牢固连接。放入电池。
- 盖上并关闭电池仓盖。



长时间不用时，请取出电池。



## 插入电池后的显示

- a) 插入电池之后，电量指示为满格但外框闪烁，此时，移液器不识别充电状态。充电3.5小时之后 - 安全为电池充满电 - 电量指示图标框外框停止闪烁。



### 提示：

插入电池之后，充电时间始终应为 3.5 个小时！  
几次完全充电之后电池电量将达到最优。

## 电池再生功能

### (恢复功能)

为延长电池使用寿命并优化电池性能，Transferpette® -8/-12 electronic 具有再生功能（恢复功能）。该程序可对电池实现受控式完全放电和充电。为优化电池性能，应定期运行再生功能。

### 执行再生功能

- a) 将AC电源适配器的充电插头插入Transferpette® -8/-12 electronic 顶部的插口。



- b) 按住向下箭头键并保持 > 3 s。  
放电过程中，电量指示进度条将从顶部到底部反复运动。



- c) 受控放电（最多3小时）之后，充电过程（3.5小时）将自动启动。充电过程中，电量指示进度条将从底部到顶部反复运动。



### 中断再生功能

按任意按钮可结束此程序。移液器自动切换至标准移液（PIP）模式和标称量程，正常充电过程自动开始，参见 222 页。拔出AC电源适配器插头也会结束程序。放电周期结束时请勿中断再生功能。

## 故障诊断

若发生错误，显示屏将显示“Err”和错误编号。按 ENTER 确认键，移液器将做出反应。按 ENTER 确认键，移液器尝试重启。

因此，将自动请求执行参考运行

问题	错误提示	可能的原因	处理措施
移液器无反应		电池没电或者故障	在不进行操作的情况下为电池充电至少 5 分钟，然后仅可在插入充电器的情况下进行操作，直至电池充满电。如有必要，更换电池。
		电子元件故障	将仪器送修。
移液器无反应		电子元件故障	将仪器送修。
移液器无反应		不可预知的程序错误	按 ENTER 确认键确认错误。移液器将重新初始化。
移液器无反应		电子元件故障	将仪器送修。
显示屏无显示	—	静电放电	取出并再次插入电池。
		电子元件故障	将仪器送修。
吸头滴漏/仪器不密封或量程出错	—	吸头不合适	请仅使用优质吸头
		吸头安装不稳妥	将吸头按紧
		活塞、吸头锥和密封圈被污染或损坏。	清洁移液器/更换密封圈。润滑活塞。
不吸液或马达噪音大	—	活塞活动受到限制	旋下并打开多道移液仓，用手移动中间的金属部件。

標記	意義
	此标志表明该产品符合 EC 指令的要求，并已按照指定的方法测试。
	该设备按照 德国计量与校准法令 以及测量和校准条例进行标识。 标识带有包括一个矩形框的字符串 DE-M (DE 代表德国) 以及年份的后两个数字 (此处: 2020)。
XXZXXXXX	序列号
	请遵守设备、附件和使用说明书中的提示。
	必须专业地处理废弃设备或电池。
	遵循使用说明。
	中国 RoHS (EFUP) EFUP 确定了电气设备或电子设备中所含有的危险材料在正常运行条件下不会泄漏或者变异的年份时间范围。在用户正常使用时，此类电气和电子产品不会导致严重的环境污染、不会对用户造成严重的人身伤害或者财物损失。
	不得将电子设备与生活垃圾一起丢弃。

## Transferpette®-8 electronic 含AC电源适配器 (100-240V/50-60 Hz)

量程	0,5-10 µl	1-20 µl	5-100 µl	10-200 µl	15-300 µl
	货号	货号	货号	货号	货号
适合欧洲/中国地区使用	7053 99	7054 00	7054 03	7054 04	7054 06
适合英国/爱尔兰地区使用	7054 09	7054 10	7054 13	7054 14	7054 16
适合美国/日本地区使用	7054 19	7054 20	7054 23	7054 24	7054 26
适合澳大利亚地区使用	7054 29	7054 30	7054 33	7054 34	7054 36

## Transferpette®-12 electronic 含AC电源适配器 (100-240V/50-60 Hz)

量程	0,5-10 µl	1-20 µl	5-100 µl	10-200 µl	15-300 µl
	货号	货号	货号	货号	货号
适合欧洲/中国地区使用	7054 49	7054 50	7054 53	7054 54	7054 56
适合英国/爱尔兰地区使用	7054 59	7054 60	7054 63	7054 64	7054 66
适合美国/日本地区使用	7054 69	7054 70	7054 73	7054 74	7054 76
适合澳大利亚地区使用	7054 79	7054 80	7054 83	7054 84	7054 86

## AC电源适配器 (100-240V/50-60 Hz)

描述	货号
适合欧洲/中国地区使用	7053 50
适合英国/爱尔兰地区使用	7053 51
适合美国/日本地区使用	7053 52
适合澳大利亚地区使用	7053 53

**Transferpette®-8/-12 electronic 零备件**

配件会因标称量程型号不同而稍有不同。(图中所示为 Transferpette® electronic 5-100 µl 移液器的零备件)



量程	A	B*	C	D
0,5 - 10 µl	7056 59	7056 77	7033 80	7033 40
1 - 20 µl	7056 71	7056 78	7033 80	7033 41
5 - 100 µl	7056 62	7056 15	7056 18	7033 44
10 - 200 µl	7056 63	7056 16	7056 18	7033 45
15 - 300 µl	7056 64	7056 17	7056 18	7033 46

\*含密封垫圈、V形环和安装工具

**BRAND 的优质吸头，预装于TipBox吸头盒**

量程	每包总吸头数	货号
0,1 - 20 µl	480	7322 02
0,5 - 20 µl	480	7322 04
2 - 200 µl	480	7322 08
5 - 300 µl	480	7322 10

**其他附件**

描述	货号
零备电池	7055 00
硅脂	7036 77
氟性全合成特种(润滑)脂	7036 78
PLT 移液器泄漏检测仪	7039 70

### 仪器送修

**重要！** 未经同意运输有毒害的物品是违反联邦法律的。

- 请仔细完整地清洁仪器并去除污染。
- 必须附上故障与使用试剂的准确描述。  
若缺失使用试剂的相关信息，则不能对仪器进行维修。
- 运输费用与风险由发送者承担。

#### 除美国与加拿大外：

- 填写"无健康危害申明"并发给您的供应商或生产商。向您的供应商或生产商索要此表格。此表格可在[www.brand.de](http://www.brand.de)下载。

#### 在美国与加拿大：

- 在寄回仪器之前联系BrandTech Scientific, Inc. 获取返修的授权号码。
- 仅接受寄回清洁的并去除污染的仪器，必须附上返修授权号码并粘贴在外包装显眼的位置，寄回返修授权号码对应的地址。

### 联系地址

#### **BRAND GMBH + CO KG**

Otto-Schott-Straße 25  
97877 Wertheim (Germany)  
Tel.: +49 9342 808-0  
Fax: +49 9342 808-98000  
E-Mail: [info@brand.de](mailto:info@brand.de)  
[www.brand.de](http://www.brand.de)

#### **USA and Canada:**

BrandTech® Scientific, Inc.  
11 Bokum Road  
Essex, CT 06426-1506 (USA)  
Tel.: +1-860-767 2562  
Fax: +1-860-767 2563  
[www.brandtech.com](http://www.brandtech.com)

#### **India:**

BRAND Scientific Equipment Pvt. Ltd.  
303, 3rd Floor, 'C' Wing, Delphi  
Hiranandani Business Park, Powai  
Mumbai - 400 076 (India)  
Tel.: +91 22 42957790  
Fax: +91 22 42957791  
E-Mail: [info@brand.co.in](mailto:info@brand.co.in)  
[www.brand.co.in](http://www.brand.co.in)

#### **中国：**

**普兰德 (上海) 贸易有限公司**  
上海市斜土路2899甲号光启文化广场  
B栋506室。200030  
电话: +86 21 6422 2318  
传真: +86 21 6422 2268  
电子邮件: [info@brand.cn.com](mailto:info@brand.cn.com)  
[www.brand.cn.com](http://www.brand.cn.com)

### 校准服务

ISO 9001与GLP要求定期检查体积计量仪器。我们建议每隔3-12个月进行检查。时间间隔由使用的要求决定。如使用频繁或经常具有侵蚀性的试剂，间隔应该短一些。具体的测试指南可在[www.brand.de](http://www.brand.de) 或 [www.brandtech.com](http://www.brandtech.com) 下载。

BRAND也提供厂方的校准服务或BRAND具有的DAkkS校准服务。只需寄回需要校准的仪器与需要哪种校准服务的申请。您可在数日内重新获得经过校准的仪器与相应的厂方校准证书或者是DAkkS校准证书。需要了解更多信息，请联系您的经销商或者BRAND。完整的订购信息可在[www.brand.de](http://www.brand.de) 下载（参见技术文档）。

## 担保信息

我们不能承担由于不当拿取，使用，服务，操作或未授权的仪器维修产生的结果，我们同样不能承担由于正常易损件如活塞，密封垫圈，阀门的磨损或者玻璃破损而产生的结果，我们也不能承担由于不按照操作手册指导的操作而产生的结果。我们不能承担由于进行任何操作手册未描述的操作与使用或由于非原装配件的使用而产生的结果。

美国与加拿大  
担保信息请看[www.brandtech.com](http://www.brandtech.com).

## 丢弃

---

右侧的标志代表电池与电子设备在寿命终结后须分别处置（不可与生活垃圾混合）。

- 根据欧洲议会 2002/96/EC 指令和 2003 年 1 月 27 日的废弃电子电气设备指令（WEEE），电子设备应依据国家有关处置法规进行处置。

- 电池含有对环境与人体健康有害的物质。因此根据根据欧洲议会 2006 年 9 月 6 日关于废弃电池的 2002/96/EC 指令，电池应依据国家有关处置法规进行处置。只有在完全放电之后才能丢弃。

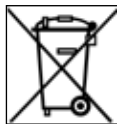

### 警告!

不可短路电池进行放电!

如有技术变更，恕不另行通知。  
对于印刷或排版错误，我方不承担任何责任。



# DECLARATION OF CONFORMITY – China RoHS 2



BRAND GMBH + CO KG has made reasonable efforts to ensure that hazardous materials and substances may not be used in BRAND products.

In order to determine the concentration of hazardous substances in all homogeneous materials of the subassemblies, a "Product Conformity Assessment" (PCA) procedure was performed. As defined in GB/T 26572 the "Maximum Concentration Value" limits (MCV) apply to these restricted substances:

- Lead (Pb): 0.1%
- Mercury (Hg): 0.1%
- Cadmium (Cd): 0.01%
- Hexavalent chromium (Cr(+VI)): 0.1%
- Polybrominated biphenyls (PBB): 0.1%
- Polybrominated diphenyl ether (PBDE): 0.1%

## Environmental Friendly Use Period (EFUP)

EFUP defines the period in years during which the hazardous substances contained in electrical and electronic products will not leak or mutate under normal operating conditions. During normal use by the user such electrical and electronic products will not result in serious environmental pollution, cause serious bodily injury or damage to the user's assets.

The environmental Friendly Use Period for BRAND instruments is 40 years.



此表格是按照SJ/T 11364-2014中规定所制定的。

This table is created according to SJ/T 11364-2014.

MATERIAL CONTENT DECLARATION FOR BRAND PRODUCTS							
有毒有害物质或元素 Hazardous substances							
部件名称 Part name	铅 Pb	汞 Hg	镉 Cd	六价铬 Cr(+VI)	多溴联苯 PBB	多溴二苯醚 PBDE	环保期限标识 EFUP
包装 / Packaging	0	0	0	0	0	0	
塑料外壳 / 组件 Plastic housing / parts	0	0	0	0	0	0	
电池 / Battery	0	0	0	0	0	0	
玻璃 / Glass	0	0	0	0	0	0	
电子电气组件 Electrical and electronic parts	X	X	X	0	0	0	
金属外壳 / 组件 Metal housing / parts	X	0	0	0	0	0	
电机 / Motor	X	0	0	0	0	0	
配件 / Accessories	X	0	0	0	0	0	

**注释:** 此表格适用于所有产品。以上列出的元件或组件不一定都属于所附产品的组成。

**Note:** Table applies to all products. Some of the components or parts listed above may not be part of the enclosed product.

- O: 表示该有毒有害物质在该部件所有均质材料中的含量均在GB/T 26572规定的限量要求以下。
- O: Indicates that the above mentioned hazardous substance contained in all homogeneous materials of the part is below the required limit as defined in GB/T 26572.
- X: 表示该有毒有害物质至少在该部件某一均质材料中的含量超出GB/T 26572规定的限量要求。
- X: Indicates that the above mentioned hazardous substance contained in at least one of the homogeneous materials of this part is above the required limit as defined in GB/T 26572.

除上表所示信息外, 还需声明的是, 这些部件并非是有意图用铅 (Pb), 汞 (Hg), 镉 (Cd), 六价铬 (Cr(+VI)), 多溴联苯 (PBB) 或多溴二苯醚 (PBDE) 来制造的。

Apart from the disclosures in the above table, the subassemblies are not intentionally manufactured or formulated with lead (Pb), mercury (Hg), cadmium (Cd), hexavalent chromium (Cr+VI), polybrominated biphenyls (PBB), and polybrominated diphenyl ethers (PBDE).

Products manufactured by BRAND may enter into further devices or can be used together with other appliances. With these third party products and appliances in particular, please note the EFUP labeled on these products. BRAND will not take responsibility for the EFUP of those products and appliances.

Place, date: Wertheim, 25/02/2019

**Hans-Walter Kern**  
(Managing Director  
Logistics and Production)

i.A.  
**Josef Pfohl**  
(Quality Management)







