

# Operating Manual

## Solid.Line™

- BD-S / BD-S-UL (E1) Incubators with natural convection
- ED-S / ED-S-UL (E1) Drying and heating ovens with natural convection
- FD-S / FD-S-UL (E1) Drying and heating ovens with forced convection

with R-S microprocessor temperature controller

Model	Model version	Art. No.
BD-S 56	BDS056-230V	9090-0016-
BD-S-UL 56	BDS056UL-120V	9090-0017
BD-S 115	BDS115-230V	9090-0022
BD-S-UL 115	BDS115UL-120V	9090-0023
ED-S 56	EDS056-230V	9090-0014
ED-S-UL 56	EDS056UL-120V	9090-0015
ED-S 115	EDS115-230V	9090-0020
ED-S-UL 115	EDS115UL-120V	9090-0021
FD-S 56	FDS056-230V	9090-0018
FD-S-UL 56	FDS056UL-120V	9090-0019
FD-S 115	FDS115-230V	9090-0024
FD-S-UL 115	FDS115UL-120V	9090-0025

### BINDER GmbH

- ▶ Address: Post office box 102, 78502 Tuttlingen, Germany ▶ Phone: +49 7462 2005 0
- ▶ Fax: +49 7462 2005 100 ▶ Internet: <http://www.binder-world.com>
- ▶ E-mail: [info@binder-world.com](mailto:info@binder-world.com) ▶ Service Hotline: +49 7462 2005 555
- ▶ Service Fax: +49 7462 2005 93 555 ▶ Service E-Mail: [customerservice@binder-world.com](mailto:customerservice@binder-world.com)
- ▶ Service Hotline USA: +1 866 885 9794 or +1 631 224 4340 x3
- ▶ Service Hotline Asia Pacific: +852 390 705 04 or +852 390 705 03
- ▶ Service Hotline Russia and CIS: +7 495 988 15 16

## Content

<b>1. SAFETY</b>	<b>4</b>
1.1 Personnel Qualification	4
1.2 Operating manual	4
1.3 Legal considerations	4
1.3.1 Intellectual property	5
1.4 Structure of the safety instructions	5
1.4.1 Signal word panel	5
1.4.2 Safety alert symbol	6
1.4.3 Pictograms	6
1.4.4 Word message panel structure	7
1.5 Localization / position of safety labels on the chamber	7
1.6 Type plate	8
1.7 General safety instructions on installing and operating the chambers	9
1.8 Intended use	10
1.9 Foreseeable Misuse	12
1.10 Residual Risks	12
<b>2. CHAMBER DESCRIPTION</b>	<b>14</b>
2.1 Chamber overview	14
2.2 Triangular instrument panel	15
<b>3. COMPLETENESS OF DELIVERY, TRANSPORTATION, STORAGE, AND INSTALLATION</b>	<b>16</b>
3.1 Unpacking, and checking equipment and completeness of delivery	16
3.2 Guidelines for safe lifting and transportation	16
3.3 Storage	17
3.4 Location of installation and ambient conditions	17
<b>4. INSTALLATION</b>	<b>18</b>
4.1 Installing the racks	18
4.2 Connection to an exhaust/ventilation system (optional)	18
4.3 Electrical connection	19
<b>5. R-S CONTROLLER OVERVIEW</b>	<b>20</b>
5.1 Menu structure overview	21
<b>6. START UP</b>	<b>21</b>
6.1 Adjusting air change	21
<b>7. TEMPERATURE SET -POINT ENTRY</b>	<b>22</b>
<b>8. SELECTING THE TEMPERATURE UNIT</b>	<b>22</b>
8.1 Setting the temperature unit	22
<b>9. OVERTEMPERATURE PROTECTION</b>	<b>23</b>
9.1 Overtemperature protective device (class 1)	23
9.2 Safety controller	23
9.2.1 Setting the safety controller	23
9.2.2 Alarm message and proceeding in case of an alarm	24
<b>10. TIMER FUNCTION “DELAYED OFF”</b>	<b>25</b>
10.1 Setting the timer run-time	25

<b>11. CLEANING AND DECONTAMINATION .....</b>	<b>25</b>
11.1 Cleaning .....	26
11.2 Decontamination / chemical disinfection .....	27
<b>12. MAINTENANCE AND SERVICE, TROUBLESHOOTING, REPAIR, TESTING... 28</b>	
12.1 General information, personnel qualification.....	28
12.2 Maintenance intervals, service.....	29
12.3 Simple troubleshooting.....	29
12.4 Sending the chamber back to BINDER GmbH .....	31
<b>13. DISPOSAL..... 31</b>	
13.1 Disposal of the transport packing.....	31
13.2 Decommissioning .....	31
13.3 Disposal of the chamber in the Federal Republic of Germany .....	32
13.4 Disposal of the chamber in the member states of the EU except for the Federal Republic of Germany .....	33
13.5 Disposal of the chamber in non-member states of the EU .....	34
<b>14. TECHNICAL DESCRIPTION..... 34</b>	
14.1 Factory calibration and adjustment .....	34
14.2 Definition of usable volume .....	34
14.3 Over current protection .....	34
14.4 Technical data .....	35
14.5 Equipment and options (extract) .....	37
14.6 Accessories and spare parts (extract) .....	37
14.7 Dimensioned drawings.....	38
14.7.1 BD-S / BD-S-UL 56.....	38
14.7.2 BD-S / BD-S-UL 115.....	39
14.7.3 ED-S / ED-S-UL 56.....	40
14.7.4 ED-S / ED-S-UL 115.....	41
14.7.5 FD-S / FD-S-UL 56 .....	42
14.7.6 FD-S / FD-S-UL 115.....	43
<b>15. CERTIFICATES AND DECLARATIONS OF CONFORMITY..... 44</b>	
15.1 EU Declaration of Conformity for BD-S.....	44
15.2 EU Declaration of Conformity for ED-S.....	46
15.3 EU Declaration of Conformity for FD-S.....	48
15.4 Certificate for the GS mark of conformity of the "VDE Prüf- und Zertifizierungsinstitut" (Testing and Certification Institute of the Association for Electrical, Electronic and Information Technologies) ...	50
15.5 Certificate of UL Compliance from Underwriters Laboratories Inc.®.....	54
<b>16. CONTAMINATION CLEARANCE CERTIFICATE ..... 55</b>	
16.1 For chambers located outside the USA and Canada .....	55
16.2 For chambers located in the USA and Canada .....	58

Dear customer,

For the correct operation of the chambers, it is important that you read this operating manual completely and carefully and observe all instructions as indicated. Failure to read, understand and follow the instructions may result in personal injury. It can also lead to damage to the chamber and/or poor equipment performance

## 1. Safety

### 1.1 Personnel Qualification



The chamber must only be installed, tested, and started up by personnel qualified for assembly, startup, and operation of the chamber. Qualified personnel are persons whose professional education, knowledge, experience and knowledge of relevant standards allow them to assess, carry out, and identify any potential hazards in the work assigned to them. They must have been trained and instructed, and be authorized, to work on the chamber.

The chamber should only be operated by laboratory personnel especially trained for this purpose and familiar with all precautionary measures required for working in a laboratory. Observe the national regulations on minimum age of laboratory personnel.

### 1.2 Operating manual

This operating manual is part of the components of delivery. Always keep it handy for reference in the vicinity of the chamber. If selling the unit, hand over the operating manual to the purchaser.

To avoid injuries and damage observe the safety instructions of the operating manual. Failure to follow instructions and safety precautions can lead to significant risks.

	<div data-bbox="392 1099 1495 1182" style="background-color: red; color: white; text-align: center;"> <b>DANGER</b></div> <p><b>Dangers due to failure to observe the instructions and safety precautions. Serious injuries and chamber damage. Risk of death.</b></p> <ul style="list-style-type: none"><li>➤ Observe the safety instructions in this Operating Manual.</li><li>➤ Follow the operating procedures in this Operating Manual.</li><li>➤ Carefully read the complete operating instructions of the chamber prior to installing and using the chamber.</li><li>➤ Keep the operating manual for future reference</li></ul>
---	---

	Make sure that all persons who use the chamber and its associated work equipment have read and understood the Operating Manual.
---	---

This Operating Manual is supplemented and updated as needed. Always use the most recent version of the Operating Manual. When in doubt, call the BINDER Service Hotline for information on the up-to-date-ness and validity of this Operating Manual.

### 1.3 Legal considerations

This operating manual is for informational purposes only. It contains information for correct and safe installing, start-up, operation, decommissioning, cleaning and maintenance of the product. Note: the contents and the product described are subject to change without notice.

Understanding and observing the instructions in this operating manual are prerequisites for hazard-free use and safety during operation and maintenance. Images are to provide basic understanding. They may deviate from the actual version of the chamber. The actual scope of delivery can, due to optional or special design, or due to recent technical changes, deviate from the information and illustrations in these instructions this operating manual. In no event shall BINDER be held liable for any damages, direct or incidental arising out of or related to the use of this manual.

This operating manual cannot cover all conceivable applications. If you would like additional information, or if special problems arise that are not sufficiently addressed in this manual, please ask your dealer or contact us directly, e.g. by phone at the number located on page one of this manual

Furthermore, we emphasize that the contents of this operating manual are not part of an earlier or existing agreement, description, or legal relationship, nor do they modify such a relationship. All obligations on the part of BINDER derive from the respective purchase contract, which also contains the entire and exclusively valid statement of warranty administration and the general terms and conditions, as well as the legal regulations valid at the time the contract is concluded. The statements in this manual neither augment nor restrict the contractual warranty provisions.

### 1.3.1 Intellectual property

**Trademark Information:** All BINDER trademarks relating to products or service, as well as trade names, logos and product names used on the website, products and documents of BINDER company are trademarks or registered trademarks of BINDER company (including BINDER GmbH, BINDER Inc.) in the U.S. and other countries and communities of states. This includes word marks, position marks, word/figurative marks, design configurations, figurative marks, and design patents.

**Patent Information:** BINDER products, categories of products, and accessories may be covered by one or more patents and/or utility models in the U.S. and other countries and communities of states. Additional patent applications may also be pending in the U.S. and other countries and communities of states.

Please visit [www.binder-world.com](http://www.binder-world.com) for more information.

## 1.4 Structure of the safety instructions

In this operating manual, the following safety definitions and symbols indicate dangerous situations following the harmonization of ISO 3864-2 and ANSI Z535.6.

### 1.4.1 Signal word panel

Depending on the probability of serious consequences, potential dangers are identified with a signal word, the corresponding safety color, and if appropriate, the safety alert symbol.

 <b>DANGER</b>
Indicates an imminently hazardous situation that, if not avoided, will result in death or serious (irreversible) injury.

 <b>WARNING</b>
Indicates a potentially hazardous situation which, if not avoided, could result in death or serious (irreversible) injury

 <b>CAUTION</b>
Indicates a potentially hazardous situation which, if not avoided, may result in moderate or minor (reversible) injury

<b>NOTICE</b>
Indicates a potentially hazardous situation which, if not avoided, may result in damage to the product and/or its functions or of a property in its proximity.

### 1.4.2 Safety alert symbol



Use of the safety alert symbol indicates a **risk of injury**.

Observe all measures that are marked with the safety alert symbol in order to avoid death or injury.

### 1.4.3 Pictograms

Warning signs			
 Electrical hazard	 Hot surface	 Explosive atmosphere	 Stability hazard
 Lifting hazard	 Risk of corrosion and / or chemical burns	 Harmful substances	 Biohazard
 Pollution Hazard			
Mandatory action signs			
 Mandatory regulation	 Read operating instructions	 Disconnect the power plug	 Lift with several persons
 Environment protection	 Wear protective gloves	 Wear safety goggles	
Prohibition signs			
 Do NOT touch	 Do NOT spray with water		



**Information** to be observed in order to ensure optimum function of the product.

#### 1.4.4 Word message panel structure

**Type / cause of hazard.**



**Possible consequences.**

- ∅ Instruction how to avoid the hazard: prohibition.
- Instruction how to avoid the hazard: mandatory action.

Observe all other notes and information not necessarily emphasized in the same way, in order to avoid disruptions that could result in direct or indirect injury or property damage.

#### 1.5 Localization / position of safety labels on the chamber

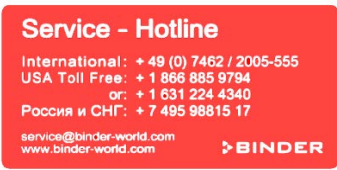
The following labels are located on the chamber:

Pictograms (Warning signs)	Service label
 <p>Hot surface</p> <ul style="list-style-type: none"> <li>• <i>ED-S / ED-S-UL, FD-S / FD-S-UL</i>: outer chamber door</li> <li>• <i>BD-S / BD-S-UL</i>: on the glass door handle</li> <li>• On the exhaust air flap</li> </ul>	
 <p>Read operating manual</p> <ul style="list-style-type: none"> <li>• <i>UL chamber</i>: outer chamber door</li> </ul>	

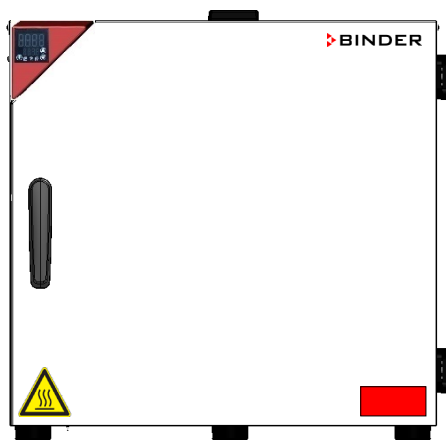

ED-S 56, FD-S 56

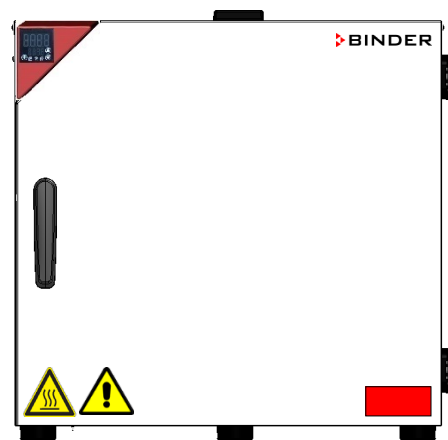

ED-S-UL 56, FD-S-UL 56

Figure 1: Position of labels on the chamber front (examples)



Keep safety labels complete and legible.

Replace safety labels that are no longer legible. Contact BINDER Service for these replacements.

## 1.6 Type plate

The type plate is located on the left-hand side of the chamber, bottom right-hand.

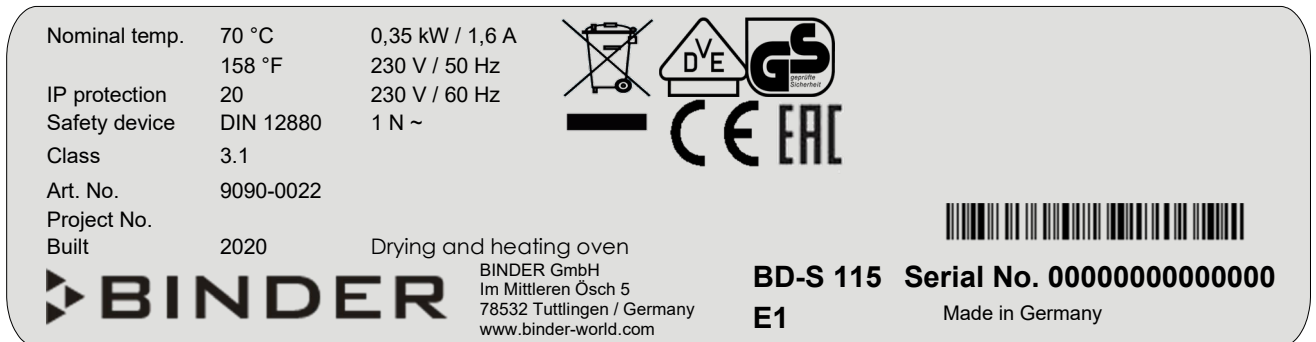





Figure 2: Type plate (example BD-S 115-230V regular chamber)

### Indications of the type plate (example)

Indication		Information
BINDER		Manufacturer: BINDER GmbH
BD-S 115		Model designation
Incubator		Chamber name: Incubator
Drying and heating oven		Chamber name: Drying and heating oven
Serial No.	000000000000	Serial No of the chamber
Built	2020	Year of construction
Nominal temperature	70 °C 158 °F	Nominal temperature
IP protection	20	IP type of protection acc. to EN 60529
Temp. safety device	DIN 12880	Temperature safety device acc. to standard DIN 12880
Class	3.1	Class of temperature safety device
Art. No.	9090-0022	Art. no. of the chamber
Project No.	---	Optional: Special application acc. to project no.
1,30 kW		Nominal power
5,7 A		Nominal current
230 V / 50 Hz		Nominal voltage +/- 10% at the indicated power frequency
230 V / 60 Hz		
1 N ~		Current type

### Symbols on the type plate

Symbol	Valid for	Information
	All chambers	CE conformity marking
	All chambers	Electrical and electronic equipment manufactured / placed on the market in the EU after 13 August 2005 and to be disposed of in a separate collection according to Directive 2012/19/EU on waste electrical and electronic equipment (WEEE).
	Not for UL chambers	GS mark of conformity of the "VDE Prüf- und Zertifizierungsinstitut" (Testing and Certification Institute of the Association for Electrical, Electronic and Information Technologies)
	Not for UL chambers	The chamber is certified according to Customs Union Technical Regulation (CU TR) for the Eurasian Economic Union (Russia, Belarus, Armenia, Kazakhstan Kyrgyzstan).



Symbol	Valid for	Information
	UL chambers only	The chamber is certified by Underwriters Laboratories Inc.® according to the following standards: <ul style="list-style-type: none"> <li>• UL 61010-2-10</li> <li>• CAN/CSA-C22.2 No. 61010-2-10</li> </ul>

## 1.7 General safety instructions on installing and operating the chambers



With regard to operating the chambers and to the installation location, please observe the local and national regulations relevant for your country (for Germany: DGUV guidelines 213-850 on safe working in laboratories, issued by the employers' liability insurance association).

BINDER GmbH is only responsible for the safety features of the chamber provided skilled electricians or qualified personnel authorized by BINDER perform all maintenance and repair, and if components relating to chamber safety are replaced in the event of failure with original spare parts.



To operate the chamber, use only original BINDER accessories or accessories from third-party suppliers authorized by BINDER. The user is responsible for any risk caused by using unauthorized accessories.

<b>NOTICE</b>	
	<p><b>Danger of overheating due to lack of ventilation.</b> <b>Damage to the chamber.</b></p> <ul style="list-style-type: none"> <li>⊘ Do NOT install the chamber in unventilated recesses.</li> <li>➤ Ensure sufficient ventilation for dispersal of the heat.</li> <li>➤ Observe the prescribed minimum distances when installing the chamber (chap. 3.4)</li> </ul>

Do not install or operate the chamber in hazardous locations.

 <b>DANGER</b>	
	<p><b>Danger of explosion due to combustible dusts or explosive mixtures in the vicinity of the chamber.</b> <b>Serious injury or death from burns and / or explosion pressure.</b></p> <ul style="list-style-type: none"> <li>⊘ Do NOT operate the chamber in potentially explosive areas.</li> <li>➤ KEEP combustible dust or air-solvent mixtures AWAY from the chamber.</li> </ul>

The chamber does not dispose of any measures of explosion protection.

 <b>DANGER</b>	
	<p><b>Danger of explosion due to introduction of flammable or explosive substances in the chamber.</b> <b>Serious injury or death from burns and / or explosion pressure.</b></p> <ul style="list-style-type: none"> <li>⊘ Do NOT introduce any substance into the chamber which is combustible or explosive at working temperature.</li> <li>⊘ Do NOT introduce any combustible dust or air-solvent mixture in the inner chamber.</li> </ul>



Any solvent contained in the charging material must not be explosive or inflammable. I.e., irrespective of the solvent concentration in the steam room, NO explosive mixture with air must form. The temperature inside the chamber must lie below the flash point or below the sublimation point of the charging material. Familiarize yourself with the physical and chemical properties of the charging material, as well as the contained moisture constituent and its behavior with the addition of heat energy.

Familiarize yourself with any potential health risks caused by the charging material, the contained moisture constituent or by reaction products that may arise during the temperature process. Take adequate measures to exclude such risks prior to putting the chamber into operation.

	 <b>DANGER</b>
	<p><b>Electrical hazard by water entering the chamber.</b>  <b>Deadly electric shock.</b></p> <ul style="list-style-type: none"> <li>∅ The chamber must NOT become wet during operation, cleaning, or maintenance.</li> <li>∅ Do NOT install the chamber in damp areas or in puddles.</li> <li>➤ Set up the chamber in a way that it is splash-proof.</li> </ul>

The chambers were produced in accordance with VDE regulations and were routinely tested in accordance to VDE 0411-1 (IEC 61010-1).

During and shortly after operation, the temperature of the inner surfaces almost equals the set-point. The glass doors and glass door handles (BD-S / BD-S-UL), inner chamber, exhaust air flap, door window (option), and the door gaskets will become hot during operation.

	 <b>CAUTION</b>
	<p><b>Danger of burning by touching hot chamber parts during operation.</b>  <b>Burns.</b></p> <ul style="list-style-type: none"> <li>∅ Do NOT touch the glass doors, inner surfaces, exhaust air flap, door window, access ports, door gaskets, or the charging material during operation.</li> <li>∅ <i>FD-S / FD-S-UL</i>: Do not place the power cable over the door gap when the chamber is hot after operation.</li> </ul>

## 1.8 Intended use

	<p>Observing the instructions in this operating manual and conducting regular maintenance work (chap. 13) is part of the intended use.</p>
---	--

**Any use of the chambers that does not comply with the requirements specified in this Operating Manual shall be considered improper use.**

**Other applications than those described in this chapter are not approved.**

### Use

The chambers are suitable for exact tempering of harmless materials and for drying and heat treatment of solid or pulverized charging material, as well as bulk material, using the supply of heat. They can be used to dry e.g. glassware, and for warm storage of liquids in containers.

Because of their precise temperature accuracy the incubators BD-S / BD-S-UL are especially useful for incubation of cultures at a standard temperature of 37 °C / 98.6 °F.



Do NOT use the chamber for drying processes when large quantities of vapor would form and result in condensation.

### Requirements for the chamber load



A solvent content must not be explosive or flammable. A mixture of any component of the charging material with air must NOT be explosive. The operating temperature must lie below the flash point or below the sublimation point of the charging material. Any component of the charging material must NOT be able to release toxic gases.

The charging material shall not contain any corrosive ingredients that may damage the machine components. Such ingredients include in particular acids and halides. Any corrosive damage caused by such ingredients is excluded from liability by BINDER GmbH.

The chamber does not dispose of any measures of explosion protection.

 	 <b>DANGER</b>
	<p><b>Explosion or implosion hazard and danger of poisoning through the introduction of unsuitable loading material.</b></p> <p><b>Poisoning. Serious injury or death from burns and / or explosion pressure.</b></p> <ul style="list-style-type: none"> <li>Ø Do NOT introduce any substance combustible or explosive at working temperature into the chamber, in particular no energy sources such as batteries or lithium-ion batteries.</li> <li>Ø NO explosive dust or air-solvent mixture in the inner chamber.</li> <li>Ø Do NOT introduce any substance which could lead to release of toxic gases.</li> </ul>

Contamination of the chamber by toxic, infectious or radioactive substances must be prevented

 	 <b>WARNING</b>
	<p><b>Danger of intoxication and infection through contamination of the chamber with toxic, infectious or radioactive substances.</b></p> <p><b>Damages to health.</b></p> <ul style="list-style-type: none"> <li>➤ Protect the interior of the chamber from contamination by toxic, infectious or radioactive substances.</li> <li>➤ Take suitable protective measures when introducing and removing toxic, infectious or radioactive material</li> </ul>

In case of foreseeable use of the device there is no risk for the user through the integration of the chamber into systems or by special environmental or operating conditions in the sense of EN 61010-1:2010. For this, the intended use of the chamber and all its connections must be observed.

#### Medical devices

The chambers are not classified as medical devices as defined by the Medical Device Directive 93/42/EEC and Regulation (EU) No 2017/745.

	<p>Due to the special demands of the Medical Device Directive (MDD), these chambers are not qualified to perform sterilization of medical devices as defined by the directive 93/42/EWG.</p>
---	--

#### Personnel Requirements

Only trained personnel with knowledge of the Operating Manual can set up and install the chamber, start it up, operate, clean, and take it out of operation. Service and repairs call for further technical requirements (e.g. electrical know-how), as well as knowledge of the service manual.

#### Installation site requirements

The chambers are designed for setting up inside a building (indoor use).

The requirements described in the Operating Manual for installation site and ambient conditions (chap. 3.4) must be met.

	<p><b>WARNING:</b> If customer should use a BINDER chamber running in non-supervised continuous operation, we strongly recommend in case of inclusion of irrecoverable specimen or samples to split such specimen or samples and store them in at least two chambers, if this is feasible.</p>
---	--

## 1.9 Foreseeable Misuse

Other applications than those described in chap. 1.8 are not approved.

This expressly includes the following misuses (the list is not exhaustive), which pose risks despite the inherently safe construction and existing technical safety equipment:

- Non-observance of Operating Manual
- Non-observance of information and warnings on the chamber (e.g. control unit messages, safety identifiers, warning signals)
- Installation, startup, operation, maintenance and repair by untrained, insufficiently qualified, or unauthorized personnel
- Missed or delayed maintenance and testing
- Non-observance of traces of wear and tear
- Insertion of materials excluded or not permitted by this Operating Manual.
- Non-compliance with the admissible parameters for processing the respective material.
- Installation, testing, service or repair in the presence of solvents
- Installation of replacement parts and use of accessories and operating resources not specified and authorized by the manufacturer
- Bypassing or changing protective systems, operation of the chamber without the designated protective systems
- Non-observance of messages regarding cleaning and disinfection of the chamber.
- Spilling water or cleaning agent on the chamber, water penetrating into the chamber during operation, cleaning or maintenance.
- Cleaning activity while the chamber is turned on.
- Operation of the chamber with a damaged housing or damaged power cord
- Continued operation of the chamber during an obvious malfunction
- Insertion of objects, particularly metallic objects, in louvers or other openings or slots on the chamber
- Human error (e.g. insufficient experience, qualification, stress, exhaustion, laziness)

To prevent these and other risks from incorrect operation, it is recommended the operator issue operating instructions and standard operating procedures (SOPs).

## 1.10 Residual Risks

The unavoidable design features of a chamber, as well as its proper field of application, can also pose risks, even during correct operation. These residual risks include hazards which, despite the inherently safe design, existing technical protective equipment, safety precautions and supplementary protective measures, cannot be ruled out.

Messages on the chamber and in the Operating Manual warn of residual risks. The consequences of these residual risks and the measures required to prevent them are listed in the Operating Manual. Moreover, the operator must take measures to minimize hazards from unavoidable residual risks. This includes, in particular, issuing operating instructions.

The following list summarizes the hazards against which this Operating Manual and the Service Manual warn, and specifies protective measures at the appropriate spots:

### **Unpacking, Transport, Installation**

- Sliding or tilting the chamber
- Setup of the chamber in unauthorized areas
- Installation of a damaged chamber

- Installation of a chamber with damaged power cord
- Inappropriate site of installation
- Missing protective conductor connection

#### **Normal operation**

- Assembly errors
- Contact with hot surfaces on the housing
- Contact with hot surfaces in the interior and inside of doors
- Emission of non-ionizing radiation from electrical operating resources
- Contact with live parts in normal state

#### **Cleaning and Decontamination**

- Penetration of water into the chamber
- Inappropriate cleaning and decontamination agents
- Enclosure of persons in the interior

#### **Malfunction and Damage**

- Continued operation of the chamber during an obvious malfunction or outage of the heating
- Contact with live parts during error status
- Operation of a unit with damaged power cord

#### **Maintenance**

- Maintenance work on live parts.
- Execution of maintenance work by untrained/insufficiently qualified personnel
- Electrical safety analysis during annual maintenance not performed

#### **Trouble-shooting and Repairs**

- Non-observance of warning messages in the Service Manual
- Trouble-shooting of live parts without specified safety measures
- Absence of a plausibility check to rule out erroneous inscription of electrical components
- Performance of repair work by untrained/insufficiently qualified personnel
- Inappropriate repairs which do not meet the quality standard specified by BINDER
- Use of replacement parts other than BINDER original replacement parts
- Electrical safety analysis not performed after repairs

## 2. Chamber description

BINDER incubators BD-S / BD-S-UL and drying and heating ovens ED-S / ED-S-UL and FD-S / FD-S-UL are equipped with an electronic PID-controller with digital display.

	<p>The incubators BD-S / BD-S-UL indicate the temperature with an accuracy of a tenth of a degree.</p> <p>The drying and heating ovens ED-S / ED-S-UL and FD-S / FD-S-UL indicate the temperature with an accuracy of one degree.</p>
---	---

All chambers are heated electrically. Incubators BD-S / BD-S-UL and drying and heating ovens ED-S / ED-S-UL are ventilated naturally. Drying and heating ovens FD-S / FD-S-UL are ventilated by fan-assisted, forced-air circulation.

The concept of air conduction guarantees high level of spatial and time-based temperature precision, thanks to the direct and distributed air circulation into the interior. With FD-S / FD-S-UL, the fan supports exact attainment and maintenance of the desired temperature accuracy.

The chambers are regularly equipped with an overtemperature safety device class 1 acc. to DIN12880:2007 and with an overtemperature safety controller (overtemperature temperature safety device class 2 (ED-S / ED-S-UL, FD-S / FD-S-UL) or class 3.1(BD-S / BD-S-UL) acc. to DIN12880:2007), see chap. 8.

**Material:** The inner chamber and the inside of the doors are made of stainless steel V2A (German material no. 1.4016, US equivalent AISI 430). Drying and heating ovens ED-S / ED-S-UL and FD-S / FD-S-UL: When operating the chambers at temperatures above 150 °C / 302 °F, the impact of the oxygen in the air may cause discoloration of the metallic surfaces (yellowish-brown or blue) by natural oxidation processes. These colorations are harmless and will in no way impair the function or quality of the chamber.

All chamber functions are easy and comfortable to use thanks to their clear arrangement. Major features are easy cleaning of all chamber parts and avoidance of undesired contamination.

Temperature ranges see technical data (chap. 16.4).

### 2.1 Chamber overview

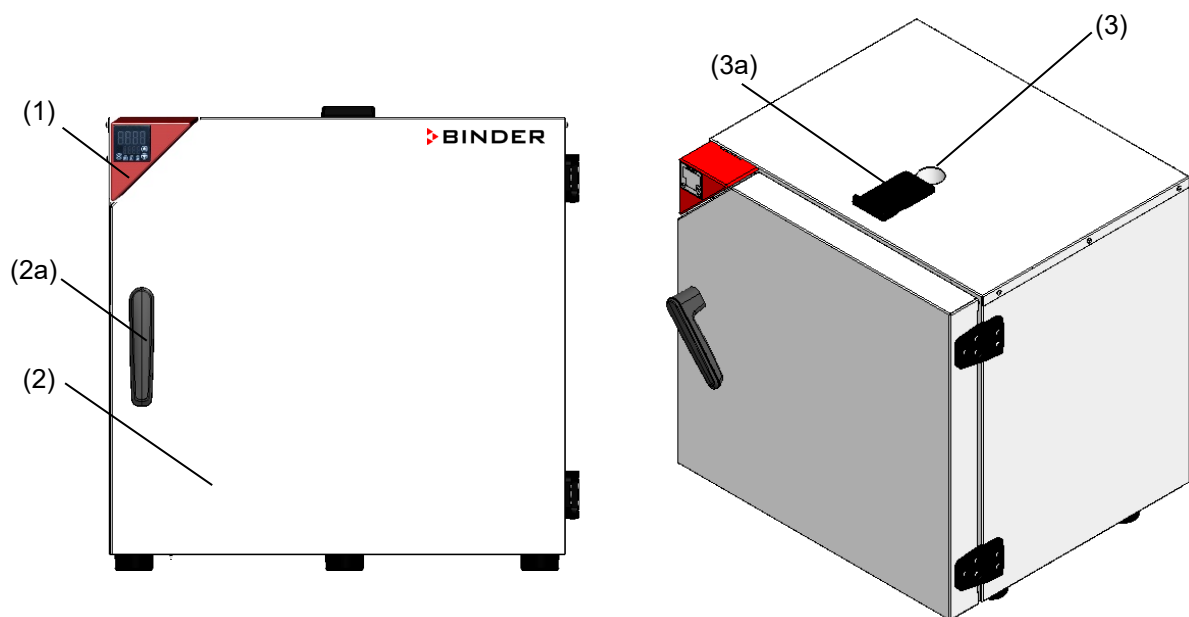

Figure 3: Chamber overview, closed chamber

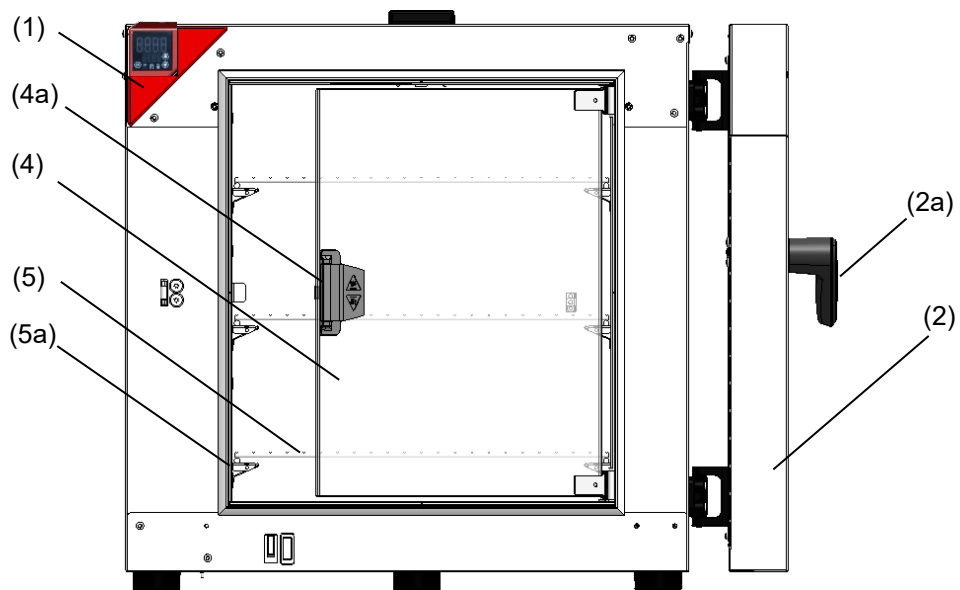

Figure 4: Chamber overview, open chamber with glass door (BD-S / BD-S-UL)

- (1) Triangular instrument panel with R-S controller
- (2) Outer door
- (2a) Outer door handle
- (3) Exhaust air outlet
- (3a) Exhaust air flap
- (4) Glass door (BD-S / BD-S-UL)
- (4a) Glass door handle (BD-S / BD-S-UL)
- (5) Rack
- (5a) Rack support

## 2.2 Triangular instrument panel

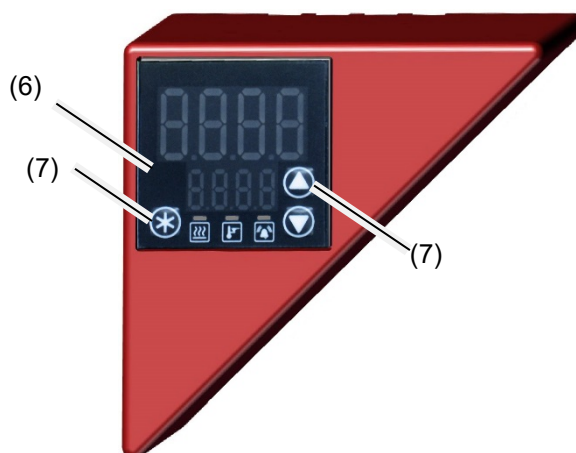

Figure 5: Triangular instrument panel with R-S controller

- (6) Controller display
- (7) Functional controller buttons





### 3. Completeness of delivery, transportation, storage, and installation

#### 3.1 Unpacking, and checking equipment and completeness of delivery

After unpacking, please check the chamber and its optional accessories, if any, based on the delivery receipt for completeness and for transportation damage. Inform the carrier immediately if transportation damage has occurred.

The final tests of the manufacturer may have caused traces of the racks on the inner surfaces. This has no impact on the function and performance of the chamber.

Please remove any transportation protection devices and adhesives in/on the chamber and on the doors and take out the operating manuals and accessory equipment.

  	 <b>CAUTION</b>
	<p><b>Risk of injury and damages by lifting heavy loads and by sliding or tilting of the chamber due to improper lifting.</b>  <b>Injuries, damage to the chamber.</b></p> <ul style="list-style-type: none"> <li>⊘ Do NOT lift or transport the chamber using the door handle or the door.</li> <li>➤ Lift the chamber from the pallet at its four lower corners with the aid of 2 people..</li> </ul>

If you need to return the chamber, please use the original packing and observe the guidelines for safe lifting and transportation (chap. 3.2).

For disposal of the transport packing, see chap. 15.1.





#### Note on second-hand chambers (Ex-Demo-Units):

Second-hand chambers are chambers that have been used for a short time for tests or exhibitions. They are thoroughly tested before resale. BINDER ensures that the chamber is technically sound and will work flawlessly.

Second-hand chambers are marked with a sticker on the chamber door. Please remove the sticker before commissioning the chamber.

#### 3.2 Guidelines for safe lifting and transportation

After operation, please observe the guidelines for temporarily decommissioning the chamber (chap. 15.2).

  	 <b>CAUTION</b>
	<p><b>Risk of injury and damages by lifting heavy loads and by sliding or tilting of the chamber due to improper transportation.</b>  <b>Injuries, damage to the chamber.</b></p> <ul style="list-style-type: none"> <li>➤ Transport the chamber only in its original packaging.</li> <li>➤ Secure the chamber with transport straps for transport.</li> <li>⊘ Do NOT lift or transport the chamber using the door handle or the door.</li> <li>➤ Lift chamber at its four lower corners with the aid of 2 people, and place it on a transport pallet with wheels. Push the pallet to the desired site and then lift the chamber from the pallet at its four lower corners.</li> </ul>



- Permissible ambient temperature range during transport:  $-10\text{ °C}$  to  $+60\text{ °C}$  /  $14\text{ °F}$  to  $140\text{ °F}$ .

You can order transport packing and pallets for transportation purposes from BINDER Service.

### 3.3 Storage

Intermediate storage of the chamber is possible in a closed and dry room. Observe the guidelines for temporary decommissioning (chap. 15.2).

- Permissible ambient temperature range during storage:  $-10\text{ °C}$  to  $+60\text{ °C}$  /  $14\text{ °F}$  to  $140\text{ °F}$ .
- Permissible ambient humidity: max. 70 % r.h., non-condensing



When after storage in a cold location you transfer the chamber to its warmer installation site, condensation may form. Before start-up, wait at least one hour until the chamber has attained ambient temperature and is completely dry.

### 3.4 Location of installation and ambient conditions

Set up the chamber on an even and non-flammable surface, free from vibration and in a well-ventilated, dry location and align it using a spirit level. The site of installation must be capable of supporting the chamber's weight (see technical data, chap. 16.4). The chambers are designed for setting up inside a building (indoor use).

	NOTICE
	<p><b>Danger of overheating due to lack of ventilation. Damage to the chamber.</b></p> <ul style="list-style-type: none"> <li>⊘ Do NOT install the chamber in unventilated recesses.</li> <li>➤ Ensure sufficient ventilation for dispersal of the heat.</li> <li>➤ Observe the prescribed minimum distances when installing the chamber.</li> </ul>

Do not install or operate the chamber in potentially explosive areas.

	 <b>DANGER</b>
	<p><b>Danger of explosion due to combustible dusts or explosive mixtures in the vicinity of the chamber. Serious injury or death from burns and / or explosion pressure.</b></p> <ul style="list-style-type: none"> <li>⊘ Do NOT operate the chamber in potentially explosive areas.</li> <li>➤ KEEP explosive dust or air-solvent mixtures AWAY from the vicinity of the chamber.</li> </ul>

#### Ambient conditions

- Permissible ambient temperature range during operation:  $+18\text{ °C}$  up to  $+40\text{ °C}$  /  $64.4\text{ °F}$  to  $104\text{ °F}$ .

At elevated ambient temperature values, fluctuations in temperature can occur.

	<p>The ambient temperature should not be substantially higher than the indicated ambient temperature of <math>+22\text{ °C} \pm 3\text{ °C}</math> / <math>71.6\text{ °F} \pm 5.4\text{ °F}</math> to which the specified technical data relate. For other ambient conditions, deviations from the indicated data are possible.</p>
---	---

- Permissible ambient humidity: 70 % r.H. max., non-condensing.
- Installation height: max. 2000 m / 6562 ft. above sea level.

#### Minimum distances

- When placing several chambers of the same size side by side, maintain a minimum distance of 250 mm / 9.84 in between each chamber.
- Wall distances: rear 160 mm / 6.30 in, sides 100 mm / 3.94 in.
- Spacing above the chamber of at least 160 mm / 6.30 in must also be accounted for.

The chambers must NOT be stacked.

	NOTICE
	<p><b>Danger by stacking.</b>  <b>Damage to the chambers.</b></p> <p>∅ Do NOT place chambers on top of each other.</p>

#### Other requirements

To completely separate the chamber from the power supply, you must disconnect the power plug. Install the chamber in a way that the power plug is easily accessible and can be easily pulled in case of danger.

For the user there is no risk of temporary overvoltages in the sense of EN 61010-1:2010.

## 4. Installation

### 4.1 Installing the racks

Insert 4 rack supports for each rack into the slots of the lateral inner chamber walls. They serve as a support for the rack.

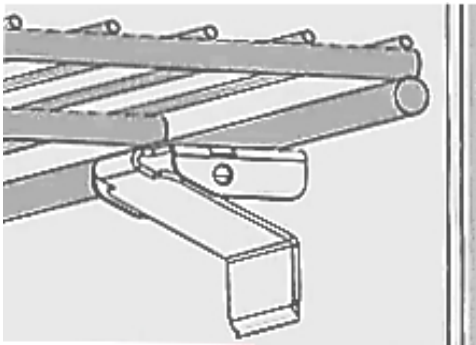



Figure 6: Rack with rack support

### 4.2 Connection to an exhaust/ventilation system (optional)



Active suction from the chamber must only be effected together with external air. Therefore, the exhaust air outlet on the top of the chamber shall not be immediately connected to an active exhaust system.

When connecting to an active exhaust system, proceed as follows:

- Remove the black exhaust air flap.
- Perforate the connecting piece of the exhaust system or place an exhaust air funnel in a distance of 3-5 cm / 1 to 2 in from the exhaust air outlet. The funnel's opening must be at least twice as large as the diameter of the exhaust air outlet.

	<p>If improperly connected to an active exhaust/ventilation system, the spatial temperature exactitude (uniformity), the heating-up and recovering times as well as the maximum temperature of the chamber may be negatively affected.</p>
---	--

The exhaust air outlet on the top of the chamber will become hot during operation.



	 CAUTION
	<p><b>Danger of burning by touching the exhaust air outlet parts during operation.</b>  <b>Burns.</b></p> <p>∅ Do NOT touch the exhaust air outlet during operation.</p>

### 4.3 Electrical connection

The chambers are supplied ready for connection and come with an IEC connector plug.

Model	Model version	Power plug of power cable	Nominal voltage +/- 10% at the indicated power frequency	Current type	Chamber fuse
BD-S 56	BD-S056-230V	Grounded plug	230 V at 50 Hz 230 V at 60 Hz	1N~	6,3 A
ED-S 56 FD-S 56	ED-S056-230V FD-S056-230V	Grounded plug	230 V at 50 Hz 230 V at 60 Hz	1N~	6,3 A
BD-S 115	BD-S115-230V	Grounded plug	230 V at 50 Hz 230 V at 60 Hz	1N~	6,3 A
ED-S 115 FD-S 115	ED-S115-230V FD-S115-230V	Grounded plug	230 V at 50 Hz 230 V at 60 Hz	1N~	6,3 A
BD-S-UL 56	BD-S056UL-120V	NEMA 5-15P	120 V at 50 Hz 120 V at 60 Hz	1N~	12,5 A
ED-S-UL 56 FD-S-UL 56	ED-S056UL-120V FD-S056UL-120V	NEMA 5-15P	120 V at 50 Hz 120 V at 60 Hz	1N~	12,5 A
BD-S-UL 115	BD-S115UL-120V	NEMA 5-15P	120 V at 50 Hz 120 V at 60 Hz	1N~	12,5 A
ED-S-UL 115 FD-S-UL 115	ED-S115UL-120V FD-S115UL-120V	NEMA 5-15P	120 V at 50 Hz 120 V at 60 Hz	1N~	12,5 A

- The domestic socket must also provide a protective conductor. Make sure that the connection of the protective conductor of the domestic installations to the chamber's protective conductor meets the latest technology. The protective conductors of the socket and plug must be compatible!

	 <b>DANGER</b>
	<p><b>Electrical hazard due to missing protective conductor connection.</b> <b>Deadly electric shock.</b></p> <ul style="list-style-type: none"> <li>➤ Make sure that the chamber's power plug and the power socket match and securely connect the electrical protective conductors of the chamber and the house installation.</li> </ul>

- Only use original connection cables from BINDER according to the above specification.  
UL chambers: Use only a UL Listed Power supply cord (UL category ELBZ). For outside USA use a certified power supply cord according to national requirements.
- Prior to connection and start-up, check the power supply voltage. Compare the values to the specified data located on the chamber's type plate (left-hand side of the chamber, chap. 1.6).

	<b>NOTICE</b>
	<p><b>Danger of incorrect power supply voltage due to improper connection.</b> <b>Damage to the chamber.</b></p> <ul style="list-style-type: none"> <li>➤ Check the power supply voltage before connection and start-up.</li> <li>➤ Compare the power supply voltage with the data indicated on the type plate.</li> </ul>

- When connecting, please observe the regulations specified by the local electricity supply company as well as the local or national electrical regulations (VDE directives for Germany).
- Observe a sufficient current protection according to the number of devices that you want to operate. We recommend the use of a residual current circuit breaker.

- *FD-S / FD-S-UL*: Do not place the power cable over the door gap when the chamber is hot after operation.
- Pollution degree (acc. to IEC 61010-1): 2
- Over-voltage category (acc. to IEC 61010-1): II

See also electrical data (chap. 16.4).







To completely separate the chamber from the power supply, you must disconnect the power plug. Install the chamber in a way that the power plug is easily accessible and can be easily pulled in case of danger.



## 5. R-S controller overview



Figure 7: Normal display (sample values)

Displays of menus or value setting (example)	
	Upper display (red): Function depending on the menu. In Normal display: Actual temperature value.
	Lower display (green): Function depending on the menu. In Normal display: Temperature set-point.

Buttons to navigate the menus and enter the values	
	The <b>arrow buttons</b> serve to navigate and to enter the values
	The <b>confirmation button</b> serves to select a menu point and to confirm the entered value. The confirmation must be made within 60 seconds. If in Normal display the <b>confirmation button</b> is pressed down for approx. 3 seconds, the display changes to standby mode (the lower display in Normal display shows "OFF"). To activate the display, press down the standby button again.

Status-LEDs for information about chamber conditions	
	Heating active
	Safety controller active
	Collective alarm

### Return to Normal display:

If no entry is made for 120 seconds, the controller returns from each menu to normal display.

To directly return from each menu to normal display, keep pressed down the **confirmation button** and press the **arrow-up button**, if appropriate, several times. Each time you press the **arrow-up button** the controller goes back one level.

## 5.1 Menu structure overview

### Normal display

- Temperature set-point entry directly via the **confirmation button** (chap. 7).

### Quick access

Access from Normal display via the **arrow buttons**:

- Setting the safety controller value (chap. 9.2.1)
- Setting the timer run-time for timer function "Delayed Off" (chap. 10.1)
- Setting the temperature unit (chap. 8.1)

## 6. Start up

Insert the plug into a suitable socket (chap. 4.2).

If there is no indication on the controller, press the **confirmation button** until the display lights up.

The controller now shows normal display (chap. 5).



Warming chambers may release odors in the first few days after commissioning. This is not a quality defect. To reduce odors quickly we recommend heating up the chamber to its nominal temperature for one day and in a well-ventilated location.

### 6.1 Adjusting air change

Opening the black exhaust air flap on top of the chamber serves to adjust the air change.

*BD-S / BD-S-UL, ED-S / ED-S-UL:* The open exhaust air flap allows increasing fresh air circulation through the exhaust air outlet.

*FD-S / FD-S-UL:* The open exhaust air flap and fan operation allow fresh air to come in through the ventilation gaps.

Note: If the exhaust air flap is completely open, the spatial temperature accuracy can be negatively influenced.

For connection to an exhaust/ventilation system see chap. 4.2.

## 7. Temperature set -point entry

Normal display shows the temperature set-point (lower display) and the actual temperature value (upper display).

*BD-S / BD-S-UL*: Setting with an accuracy of a tenth of a degree. Setting range: 0 °C / 31 °F up to 70 °C / 158 °F

*ED-S / ED-S-UL, FD-S / FD-S-UL*: Setting with an accuracy one degree. Setting range: 0 °C / 31 °F up to 250 °C / 482 °F

### Setting:

In Normal display press the **confirmation button**.

The current temperature set-point (lower display) flashes.

Enter the desired temperature set-point with the **arrow buttons** and confirm with the **confirmation button**.

The controller will now equilibrate to the new temperature set-point.

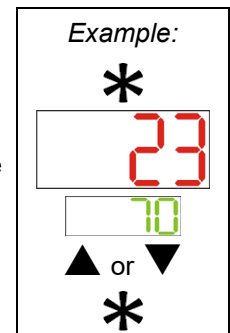

Check and/or adjust the safety controller following any changes of the set-point (chap. 8).

## 8. Selecting the temperature unit

You can set the temperature unit to degrees Celsius °C or degrees Fahrenheit °F.

If the unit is changed, all temperature values are converted accordingly.



C = degrees Celsius	0 °C = 31°F	Conversion:
F= degrees Fahrenheit	100 °C = 212°F	[Value in °F] = [Value in °C] * 1,8 + 32

### 8.1 Setting the temperature unit

#### Setting:

In Normal display press the **arrow-up button 3 times** to access the "Unit" setting menu (temperature unit).

The „Unit“ menu is shown with the current temperature unit.

Press the **confirmation button** to activate the entry. The display "Unit" flashes.

Select the desired unit with the **arrow buttons** and confirm with the **confirmation button**.

The new temperature unit is activated.

Press the **arrow-down button 3 times** to return to Normal display.

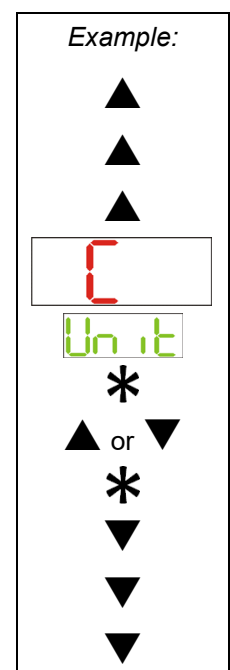

## 9. Overtemperature protection

### 9.1 Overtemperature protective device (class 1)

The chambers are equipped with an internal temperature safety device, class 1 acc. to DIN 12880:2007. It serves to protect the unit and prevents dangerous conditions caused by major defects.

If the cut-off temperature is reached, the over temperature protective device permanently turns off the unit. The user cannot restart the device again. The protective cut-off device is located internally. Only a service specialist can replace it. Therefore, please contact an authorized service provider or BINDER service.

#### Cut-off temperature values:

*BD-S / BD-S-UL: 90 °C / 194 °F*

*ED-S / ED-S-UL, FD-S / FD-S-UL: 318 °C / 604.4 °F*

### 9.2 Safety controller

The chambers are regularly equipped with an adjustable electronic safety controller. It serves to protect the chamber, its environment and the contents against exceeding the maximum permissible temperature. Please observe the regulations applicable to your country (for Germany: DGUV guidelines 213-850 on safe working in laboratories, issued by the employers' liability insurance association).

Depending on the chamber type the safety controller acts as an over temperature safety device class 2 ("temperature limiter") or class 3.1 ("temperature protection") acc. to DIN 12880:2007.

- ***BD-S / BD-S-UL: Safety controller class 3.1***

The safety controller class 3.1 limits the temperature inside the chamber to the entered safety controller set-point. In the event of a fault (if this maximum temperature is exceeded), it takes over the control to this value. This status is reported visually by an alarm message.

The safety controller keeps control of the chamber until the chamber temperature cools down below the safety controller set-point value.

- ***ED-S / ED-S-UL, FD-S / FD-S-UL: Safety controller class 2***

The safety controller class 2 limits the temperature inside the chamber to the entered safety controller set-point. In the event of a fault (if this maximum temperature is exceeded) the safety controller completely turns off the heating until manual reset. This status is reported visually by an alarm message.

#### Function check:

Check the safety controller at appropriate intervals for its functionality. It is recommended that the authorized operating personnel should perform such a check, e.g., before starting a longer work procedure.

#### 9.2.1 Setting the safety controller

A limit temperature is entered as the safety controller set-point, i.e. the absolute maximum permitted temperature value.

*BD-S / BD-S-UL: Setting with an accuracy of a tenth of a degree. 0 °C / 31 °F up to 80 °C / 176 °F*

*ED-S / ED-S-UL, FD-S / FD-S-UL: Setting with an accuracy one degree. 0 °C / 31 °F up to 260 °C / 500 °F*



Regularly check the safety controller setting relating to the entered temperature set-point  
Set the safety controller set-point by approx. 2 °C to 5 °C above the desired temperature set-point.

### Setting:

In Normal display press the **arrow-up button** to access the “OCtl” (safety controller) setting menu.

The current safety controller value is shown (upper display)

Press the **confirmation button**. The display “OCtl” flashes.

Enter the desired safety controller value with the **arrow buttons** and confirm with **confirmation button**.

The new safety controller value is activated.

Press the **arrow-down button** to return to Normal display.

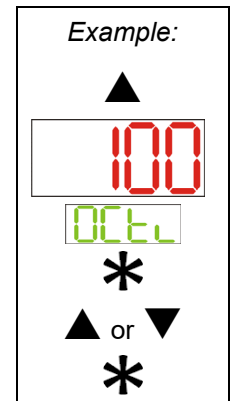

## 9.2.2 Alarm message and proceeding in case of an alarm



The status LED “Heating active” is lit.

- **BD-S / BD-S-UL: Safety controller class 3.1**

The safety controller keeps control of the chamber until the chamber temperature cools down below the entered safety controller value. First the heating turns off. As soon as the inner chamber temperature has cooled down below the safety controller set-point, the heating is released and temperature control is resumed by the controller.

If the safety controller class 3.1 has repeatedly taken over control, we recommend proceeding as follows:

- Disconnect the chamber from the power supply.
- Have an expert examine and rectify the cause of the fault.
- Restart the chamber

- **ED-S / ED-S-UL, FD-S / FD-S-UL: Safety controller class 2**

The heating turns off.

As soon as the inner chamber temperature has cooled down below the safety controller value, you can reset the alarm message on the controller. Press the **confirmation button**. The heating is then released and temperature control is resumed by the controller. The status LED “Heating active” is off.

If the safety controller class 2 has turned off the heating, we recommend proceeding as follows:

- Disconnect the chamber from the power supply.
- Have an expert examine and rectify the cause of the fault.
- Restart the chamber
- Reset the alarm message with the **confirmation button**



## 10. Timer function “Delayed Off”

The chambers offer the timer function “Delayed Off”.

This function serves to set a delay time until the control is turned off.

The selected timer run-time immediately starts running down.

When the timer expires, control deactivates (standby mode), heating and fan (with FD-S / FD-S-UL) turn off. The lower display in Normal display shows “OFF”.

### 10.1 Setting the timer run-time

In Normal display press the **arrow-up button twice** to access the “tOFF” entry menu.

The current timer run-time [hh.mm] is displayed (upper display)

Press the **confirmation button** to activate the entry. The display “tOFF” flashes.

Set the desired timer run-time with the **arrow buttons** and confirm with the **confirmation button**.



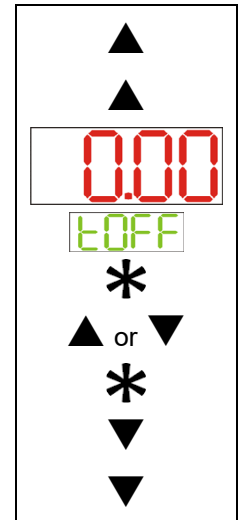

Press the **arrow-down button twice** to return to Normal display.



## 11. Cleaning and decontamination

Clean the chamber after each use to avoid potential corrosion damage by ingredients of the test material.

Prior to renewed startup, allow the chamber to completely dry after all cleaning and decontamination measures.

	 <b>DANGER</b>
	<p><b>Electrical hazard by water entering the chamber.</b>  <b>Deadly electric shock.</b></p> <ul style="list-style-type: none"> <li>Ø Do NOT spill water or cleaning agents over the inner and outer chamber surfaces.</li> <li>Ø Do NOT put ANY cleaning aids (cloth or brush) into slots or openings on the chamber.</li> <li>➤ Disconnect the power plug before cleaning. Let the chamber cool down to ambient temperature.</li> <li>➤ Completely dry the chamber before turning it on again.</li> </ul>
	

## 11.1 Cleaning

Disconnect the chamber from the power supply before cleaning. Disconnect the power plug.



The interior of the chamber must be kept clean. Thoroughly remove any residues of the charging material

Wipe the surfaces with a moistened towel. In addition, you can use the following cleaning agents:

Exterior surfaces inner chamber racks door gaskets	Standard commercial cleaning detergents free from acid or halides. Alcohol-based solutions. We recommend using the neutral cleaning agent Art. No. 1002-0016.
Instrument panel	Standard commercial cleaning detergents free from acid or halides. We recommend using the neutral cleaning agent Art. No. 1002-0016.
Zinc coated hinge parts rear chamber wall	Standard commercial cleaning detergents free from acid or halides. Do NOT use a neutral cleaning agent on zinc coated surfaces.

Do not use cleaning agents that may cause a hazard due to reaction with components of the device or the charging material. If there is doubt regarding the suitability of cleaning products, please contact BINDER service.



We recommend using the neutral cleaning agent Art. No. 1002-0016 for a thorough cleaning. Any corrosive damage that may arise following use of other cleaning agents is excluded from liability by BINDER GmbH.  
Any corrosive damage caused by a lack of cleaning, is excluded from liability by BINDER GmbH.



### NOTICE

**Danger of corrosion by using unsuitable cleaners.**

**Damage to the chamber.**

- ∅ Do NOT use acidic or chlorine cleaning detergents.
- ∅ Do NOT use a neutral cleaning agent on other kind of surfaces e.g., the zinc coated hinge parts or the rear chamber wall.



For surface protection, perform cleaning as quickly as possible.  
After cleaning completely remove cleaning agents from the surfaces with a moistened towel.  
Let the chamber dry.



Soapsuds may contain chlorides and must therefore NOT be used for cleaning.





With every decontamination method, always use adequate personal safety controls.

Following cleaning, leave the chamber door open or remove the access port plugs.



The neutral cleaning agent may cause health problems in contact with skin and if ingested. Follow the operating instructions and safety hints labeled on the bottle of the neutral cleaning agent.

Recommended precautions: To protect the eyes use sealed protective goggles. Wear gloves. Suitable protective gloves in full contact with media: butyl or nitrile rubber, penetration time >480 minutes.

	 <b>CAUTION</b>
	<p><b>Danger of chemical burns through contact with skin or ingestion of the neutral cleaning agent.</b></p> <p><b>Skin and eye damage. Environmental damage.</b></p> <ul style="list-style-type: none"> <li>Ø Do not ingest the neutral cleaning agent. Keep it away from food and beverages.</li> <li>Ø Do NOT empty the neutral cleaning agent into drains.</li> <li>➤ Wear protective gloves and goggles.</li> <li>➤ Avoid skin contact with the neutral cleaning agent.</li> </ul>

## 11.2 Decontamination / chemical disinfection

The operator must ensure that proper decontamination is performed in case a contamination of the chamber by hazardous substances has occurred.

Disconnect the chamber from the power supply prior to decontamination. Pull the power plug.

Do not use decontamination agents that may cause a hazard due to reaction with components of the device or the charging material. If there is doubt regarding the suitability of cleaning products, please contact BINDER service.

You can use the following disinfectants:

Inner chamber	Standard commercial surface disinfectants free from acid or halides. Alcohol-based solutions. We recommend using the disinfectant spray Art. No. 1002-0022.
---------------	---

	For chemical disinfection, we recommend using the disinfectant spray Art. No. 1002-0022. Any corrosive damage that may arise following use of other disinfectants is excluded from liability by BINDER GmbH.
---	--

	With every decontamination / disinfection method, always use adequate personal safety controls.
---	---

In case of impurity of the interior with biological or chemical hazardous material, there are three possible procedures depending on the type of contamination and of the charging material.



1. The drying and heating ovens ED-S / ED-S-UL and FD-S / FD-S-UL can be hot air sterilized at 190 °C / 374 °F for at least 30 minutes. All inflammable goods must be removed from the interior before.
2. Spray the inner chamber with an appropriate disinfectant.

Before start-up, the chamber must be absolute dry and ventilated, because explosive gases may form during the decontamination process.

3. You can remove the racks and the rack supports from the chamber and sterilize them

	In case of eye contact, the disinfectant spray may cause eye damage due to chemical burns. Follow the operating instructions and safety hints labeled on the bottle of the disinfectant spray.
---	--

Recommended precautions: To protect the eyes use sealed protective goggles.

	<div style="background-color: yellow; text-align: center; padding: 5px;">  <b>CAUTION</b> </div> <p><b>Danger of chemical burns through eye contact with the disinfectant spray.</b></p> <p><b>Eye damage. Environmental damage</b></p> <ul style="list-style-type: none"> <li>∅ Do NOT empty the disinfectant into drains.</li> <li>➤ Wear protective goggles.</li> </ul>
---	---

	<p>After using the disinfectant spray, allow the chamber to dry thoroughly, and aerate it sufficiently.</p>
---	---

## 12. Maintenance and service, troubleshooting, repair, testing

### 12.1 General information, personnel qualification

- **Maintenance**

See chap. 14.2

- **Simple troubleshooting**

Chap. 14.3 describes troubleshooting by operating personnel. It does not require technical intervention into the chamber, nor disassembly of chamber parts.

For personnel requirements please refer to chap. 1.1.

- **Detailed troubleshooting**

If errors cannot be identified with simple troubleshooting, further troubleshooting must be performed by BINDER Service or by BINDER qualified service partners or technicians, in accordance with the description in the Service Manual.

For personnel requirements please refer to the Service Manual.

- **Repair**

Repair of the chamber can be performed by BINDER Service or by BINDER qualified service partners or technicians, in accordance with the description in the Service Manual.



After maintenance, the chamber must be tested prior to resuming operation.

- **Electrical testing**

To prevent the risk of electrical shock from the electrical equipment of the chamber, an annual repeat inspection as well as a test prior to initial startup and prior to resuming operation after maintenance or repair, are required. This test must meet the requirements of the competent public authorities. We recommend testing under DIN VDE 0701-0702:2008 in accordance with the details in the Service Manual.

For personnel requirements please refer to the Service Manual.

## 12.2 Maintenance intervals, service

 	 <b>DANGER</b>
	<p><b>Electrical hazard during live maintenance work.</b>  <b>Deadly electric shock.</b></p> <ul style="list-style-type: none"> <li>Ø The chamber must NOT become wet during operation or maintenance work.</li> <li>Ø Do NOT remove the rear panel of the chamber.</li> <li>➤ Disconnect the chamber before conducting maintenance work. Disconnect the power plug.</li> <li>➤ Ensure all maintenance work is conducted by licensed electricians or experts authorized by BINDER.</li> </ul>

Ensure regular maintenance work is performed at least once a year and that the legal requirements are met regarding the qualifications of service personnel, scope of testing and documentation.

	The warranty becomes void if maintenance work is conducted by non-authorized personnel..
---	--

	Replace the door gasket only when cold. Otherwise, the door gasket may become damaged.
---	--

We recommend taking out a maintenance agreement. Please consult BINDER Service.

BINDER telephone hotline:	+49 (0) 7462 2005 555
BINDER fax hotline:	+49 (0) 7462 2005 93555
BINDER e-mail hotline:	customerservice@binder-world.com
BINDER service hotline USA:	+1 866 885 9794 or +1 631 224 4340 x3 (toll-free in the USA)
BINDER service hotline Asia Pacific:	+852 390 705 04 or +852 390 705 03
BINDER service hotline Russia and CIS	+7 495 988 15 16
BINDER Internet website	<a href="http://www.binder-world.com">http://www.binder-world.com</a>
BINDER address	BINDER GmbH, post office box 102, D-78502 Tuttlingen

International customers, please contact your local BINDER distributor.

## 12.3 Simple troubleshooting

Defects and shortcomings can compromise the operational safety of the chamber and can lead to risks and damage to equipment and persons. If there is a technical fault or shortcoming, take the chamber out of operation and inform BINDER Service. If you are not sure whether there is a technical fault, proceed according to the following list. If you cannot clearly identify an error or there is a technical fault, please contact BINDER Service.

	Only qualified service personnel authorized by BINDER must perform repair. Repaired chambers must comply with the BINDER quality standards.
---	---

Fault description	Possible cause	Required measures
Chamber without function. Controller display is dark.	No power supply.	Check connection to power supply.
	Overtemperature protective device class 1 has turned off the chamber.	Contact BINDER service.
	Controller defective.	Contact BINDER service.
Chamber without function. Controller shows "OFF" on lower display and actual temperature value on upper display.	Chamber in standby mode.	Press the <b>confirmation button</b> .

Fault description	Possible cause	Required measures
Set-point temperature is not reached after specified time.	Chamber door not properly closed.	Completely close chamber door.
	Door gasket defective.	Replace door gasket,
	Controller not adjusted.	Calibrate and adjust controller.
	Wrong voltage.	Check the power supply for correct voltage (chap. 4.2).
<i>FD-S / FD-S-UL:</i> The fan doesn't turn or turns too slowly.	Fan defective.	Contact BINDER service.
Chamber heating permanently, set-point not held.	Controller defective.	Contact BINDER service.
	Pt 100 sensor defective.	
	Semiconductor relay defective	
	Controller not adjusted.	Calibrate and adjust controller.
Chamber doesn't heat up. Status LED "Heating active" is lit.	Heating element defective.	Contact BINDER service.
	Semiconductor relay defective.	
Chamber doesn't heat up. Status LED "Heating active" is not lit. Controller display working.	Timer run off.	Re-program the timer or turn it off.
	Semiconductor relay defective.	Contact BINDER service.
	Controller defective.	
Chamber doesn't heat up. Status LED "Safety controller active" is lit.	<i>BD-S / BD-S-UL:</i> Safety controller class 3.1 has responded.	Check the settings of the temperature set-point and of the safety controller. If appropriate, select suitable limit value. See chap. 9.2.
	<i>ED-S / ED-S-UL, FD-S / FD-S-UL:</i> Safety controller class 2 has turned off the heating.	Let cool down the chamber. Press the <b>confirmation button</b> (chap. 9.2.2). Check the settings of the temperature set-point and of the safety controller. If appropriate, select suitable limit value.
	Safety controller defective.	Contact BINDER service.
Deviations from the indicated heating-up times.	Chamber fully loaded.	Load the chamber less or consider longer heating-up times.
Controller shows "OFF" on lower display and "OPEN" on upper display.	Sensor rupture between sensor and controller.	Contact BINDER service.

## 12.4 Sending the chamber back to BINDER GmbH

If you return a BINDER product to us for repair or any other reason, we will only accept the product upon presentation of an **authorization number** (RMA number) that has previously been issued to you. An authorization number will be issued after receiving your complaint either in writing or by telephone **prior** to your sending the BINDER product back to us. The authorization number will be issued following receipt of the information below:

- BINDER product type and serial number
- Date of purchase
- Name and address of the dealer from which you bought the BINDER product
- Exact description of the defect or fault
- Complete address, contact person and availability of that person
- Exact location of the BINDER product in your facility
- A contamination clearance certificate (chap. 18) must be faxed in advance

The authorization number must be applied to the packaging in such a way that it can be easily recognized or be recorded clearly in the delivery documents.



For safety reasons we cannot accept a chamber delivery if it does not carry an authorization number.

**Return address:** BINDER GmbH, Abteilung Service  
Gänsäcker 16, 78502 Tuttlingen, Germany

## 13. Disposal

### 13.1 Disposal of the transport packing

Packing element	Material	Disposal
Straps to fix packing on pallet	Plastic	Plastic recycling
Wooden transport box (option) with metal screws	Non-wood (compressed match-wood, IPPC standard)	Wood recycling
	Metal	Metal recycling
Pallet (size 115)	Solid wood (IPPC standard)	Wood recycling
Transport box with metal clamps	Cardboard	Paper recycling
	Metal	Metal recycling
Edge protection	Styropor® or PE foam	Plastic recycling
Protection of doors and racks	PE foam	Plastic recycling
Bag for operating manual	PE foil	Plastic recycling
Insulating air cushion foil (packing of optional accessories)	PE foil	Plastic recycling

If recycling is not possible, all packing parts can also be disposed of with normal waste.

### 13.2 Decommissioning

- Disconnect the chamber from the power supply (pull the power plug).
- Temporal decommissioning: See indications for appropriate storage, chap. 3.3.
- Final decommissioning: Dispose of the chamber as described in chap. 15.3 to 15.5.



### 13.3 Disposal of the chamber in the Federal Republic of Germany

According to Annex I of Directive 2012/19/EU of the European Parliament and of the Council on waste electrical and electronic equipment (WEEE), BINDER devices are classified as “monitoring and control instruments” (category 9) only intended for professional use“. They must not be disposed of at public collecting points.

The chambers bear the symbol for the marking of electrical and electronic equipment manufactured / placed on the market in the EC after 13 August 2005 and be disposed of in separate collection according to Directive 2012/19/EU on waste electrical and electronic equipment (WEEE) and German national law for electrical and electronic equipment (Elektro- und Elektronikgerätegesetz, ElektroG). WEEE marking: crossed-out wheeled bin with solid bar under. A significant part of the materials must be recycled in order to protect the environment.



At the end of the device's service life, have the device disposed of according to the German national law for electrical and electronic equipment (Elektro- und Elektronikgerätegesetz, ElektroG from 20 October 2015, BGBl. I p. 1739) or contact BINDER service who will organize taking back and disposal of the chamber according to the German national law for electrical and electronic equipment (Elektro- und Elektronikgerätegesetz, ElektroG from 20 October 2015, BGBl. I p. 1739).

	NOTICE
	<p><b>Danger of violation against existing law if not disposed of properly.</b>  <b>Failure to comply with applicable law.</b></p> <ul style="list-style-type: none"> <li>∅ Do NOT dispose of BINDER devices at public collecting points.</li> <li>➤ Have the device disposed of professionally at a recycling company, which is certified according to the German national law for electrical and electronic equipment (Elektro- und Elektronikgerätegesetz, ElektroG from 20 October 2015, BGBl. I p. 1739).</li> <li style="text-align: center;"><i>or</i></li> <li>➤ Instruct BINDER Service to dispose of the device. The general terms of payment and delivery of BINDER GmbH apply, which were valid at the time of purchasing the chamber.</li> </ul>

Certified companies disassemble waste BINDER equipment in primary substances for recycling according to Directive 2012/19/EU. In order to eliminate any health hazards to the employees of the recycling companies, the devices must be free from toxic, infectious or radioactive substances.

	<p>Prior to handing the chamber over to a recycling company, it is the user's responsibility that it is free from toxic, infectious or radioactive substances.</p> <ul style="list-style-type: none"> <li>• Prior to disposal, clean all introduced or residual toxic substances from the chamber.</li> <li>• Prior to disposal, disinfect the chamber from all sources of infection. Be aware of the fact that sources of infection may also be located outside the inner chamber.</li> <li>• If you cannot safely remove all toxic substances and sources of infection from the chamber, dispose of it as “special” waste according to national law.</li> <li>• Fill out the contamination clearance certificate (chap. 18) and enclose it with the chamber.</li> </ul>
---	---

	WARNING
	<p><b>Danger of intoxication and infection through contamination of the chamber with toxic, infectious or radioactive substances.</b>  <b>Damages to health.</b></p> <ul style="list-style-type: none"> <li>∅ NEVER take a chamber contaminated with toxic substances or sources of infection for recycling according to Directive 2012/19/EU.</li> <li>➤ Prior to disposal, remove all toxic substances and sources of infection from the chamber.</li> <li>➤ Dispose of a chamber from which all toxic substances or sources of infection cannot be safely removed as special waste according to national law.</li> </ul>



### 13.4 Disposal of the chamber in the member states of the EU except for the Federal Republic of Germany

According to Annex I of Directive 2012/19/EU of the European Parliament and of the Council on waste electrical and electronic equipment (WEEE), BINDER devices are classified as “monitoring and control instruments” (category 9) only intended for professional use“. They must not be disposed of at public collecting points.

The chambers bear the symbol for the marking of electrical and electronic equipment manufactured / placed on the market in the EC after 13 August 2005 and be disposed of in separate collection according to the Directive 2012/19/EU on waste electrical and electronic equipment (WEEE). WEEE marking: crossed-out wheeled bin with solid bar under.





At the end of the device’s service life, notify the distributor who sold you the device, who will take back and dispose of the chamber according to the Directive 2012/19/EU on waste electrical and electronic equipment (WEEE).



	<div style="background-color: #00a0e3; color: white; padding: 5px; text-align: center; font-weight: bold;">NOTICE</div> <p><b>Danger of violation against existing law if not disposed of properly. Failure to comply with applicable law.</b></p> <ul style="list-style-type: none"> <li>⊘ Do NOT dispose of BINDER devices at public collecting points.</li> <li>➤ Have the device disposed of professionally at a recycling company, which is certified according to conversion of the Directive 2012/19/EU into national law. <i>or</i></li> <li>➤ Instruct the distributor who sold you the device to dispose of it. The agreements apply that were reached with the distributor when purchasing the chamber (e.g. his general terms of payment and delivery).</li> <li>➤ If your distributor is not able to take back and dispose of the chamber, please contact BINDER service.</li> </ul>
---	---

Certified companies disassemble waste BINDER equipment in primary substances for recycling according to Directive 2012/19/EU. In order to exclude any health hazard for the employees of the recycling companies, the devices must be free from toxic, infectious or radioactive substances.

	<p>Prior to handing the chamber over to a recycling company, it is the user’s responsibility that it is free from toxic, infectious or radioactive substances.</p> <ul style="list-style-type: none"> <li>• Prior to disposal, clean all introduced or residual toxic substances from the chamber.</li> <li>• Prior to disposal, disinfect the chamber from all sources of infection. Be aware of the fact that sources of infection may also be located outside the inner chamber.</li> <li>• If you cannot safely remove all sources of infection and toxic substances from the chamber, dispose of it as “special” waste according to national law.</li> <li>• Fill out the contamination clearance certificate (chap. 18) and enclose it with the chamber.</li> </ul>
---	---

 	<div style="background-color: #ffa500; color: black; padding: 5px; text-align: center; font-weight: bold;">  <b>WARNING</b> </div> <p><b>Danger of intoxication and infection through contamination of the chamber with toxic, infectious or radioactive substances.</b></p> <p><b>Damages to health.</b></p> <ul style="list-style-type: none"> <li>⊘ NEVER take a chamber contaminated with toxic substances or sources of infection for recycling according to Directive 2012/19/EU.</li> <li>➤ Prior to disposal, remove all toxic substances and sources of infection from the chamber.</li> <li>➤ Dispose of a chamber from which all toxic substances or sources of infection cannot be safely removed as “special” waste according to national law.</li> </ul>
--	---

## 13.5 Disposal of the chamber in non-member states of the EU

 	NOTICE
	<p><b>Danger of violation against existing law if not disposed of properly.</b>  <b>Failure to comply with applicable law. Alteration of the environment.</b></p> <ul style="list-style-type: none"> <li>➤ For final decommissioning and disposal of the chamber, please contact BINDER Service.</li> <li>➤ Follow the statutory regulations for appropriate, environmentally friendly disposal.</li> </ul>

## 14. Technical description

### 14.1 Factory calibration and adjustment

This chamber was calibrated and adjusted in the factory. Calibration and adjustment were performed using standardized test instructions, according to the QM DIN EN ISO 9001 system applied by BINDER (certified since December 1996 by TÜV CERT). All test equipment used is subject to the administration of measurement and test equipment that is also constituent part of the BINDER QM DIN EN ISO 9001 systems. They are controlled and calibrated to a DKD-Standard at regular intervals.

	Repeated calibrations are recommended in periods of 12 months.
---	--

### 14.2 Definition of usable volume

The usable volume illustrated below is calculated as follows:

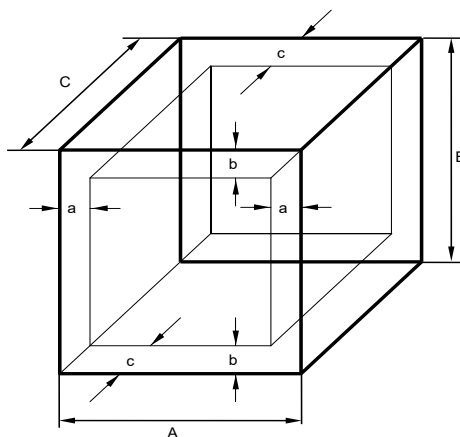

A, B, C = Internal dimensions (W, H, D)

a, b, c = Wall clearances

$$a = 0.1 \times A$$

$$b = 0.1 \times B$$

$$c = 0.1 \times C$$

$$V_{USE} = (A - 2a) \times (B - 2b) \times (C - 2c)$$

Figure 8: Determination of the useable volume

The technical data refers to the defined usable volume.

	<p>Do NOT place samples outside this usable volume.</p> <p>Do NOT load this volume by more than half to enable sufficient airflow inside the chamber.</p> <p>Do NOT divide the usable volume into separate parts with large area samples.</p> <p>Do NOT place samples too close to each other in order to permit circulation between them and thus obtain a homogenous distribution of temperature.</p>
---	---

### 14.3 Over current protection

The chambers are protected by one (UL chambers) or two miniature fuses against over current, accessible from the outside. The miniature fuses are located at the rear of the chamber above the power cable connection. Each fuse holder is equipped with a fuse clip 5mm x 20 mm (cUL-Version 6,3x32 mm). A fuse may be replaced only with a substitute of the same ratings. Refer to the technical data of the respective device type.

## 14.4 Technical data

Model		BD-S BD-S-UL	ED-S ED-S-UL	FD-S FD-S-UL	BD-S BD-S-UL	ED-S ED-S-UL	FD-S FD-S-UL	
Chamber size		56	56	56	115	115	115	
<b>Exterior dimensions</b>								
Width, net	mm / inch	595 / 23.43	595 / 23.43	595 / 23.43	745 / 29.33	745 / 29.33	745 / 29.33	
Height, gross (incl. feet)	mm / inch	625 / 24.60	625 / 24.60	625 / 24.60	735 / 28.94	735 / 28.94	735 / 28.94	
Depth, net	mm / inch	525 / 20.67	525 / 20.67	525 / 20.67	565 / 22.24	565 / 22.24	565 / 22.24	
Depth, gross (incl. door handle)	mm / inch	580 / 22.83	580 / 22.83	580 / 22.83	620 / 24.41	620 / 24.41	620 / 24.41	
Wall clearance rear (minimum)	mm / inch	160 / 6.30	160 / 6.30	160 / 6.30	160 / 6.30	160 / 6.30	160 / 6.30	
Wall clearance side (minimum)	mm / inch	100 / 3.94	100 / 3.94	100 / 3.94	100 / 3.94	100 / 3.94	100 / 3.94	
Spacing above the chamber	mm / inch	160 / 6.30	160 / 6.30	160 / 6.30	160 / 6.30	160 / 6.30	160 / 6.30	
Exhaust air outlet, inner diameter	mm / inch	50 / 1.97	50 / 1.97	50 / 1.97	50 / 1.97	50 / 1.97	50 / 1.97	
<b>Doors</b>								
Number of doors		1	1	1	1	1	1	
Number of inner glass doors		1	--	--	1	--	--	
<b>Interior dimensions</b>								
Width	mm / inch	400 / 15.75	400 / 15.75	400 / 15.75	550 / 21.65	550 / 21.65	550 / 21.65	
Height	mm / inch	440 / 17.32	440 / 17.32	440 / 17.32	550 / 21.65	550 / 21.65	550 / 21.65	
Depth	mm / inch	350 / 13.78	350 / 13.78	310 / 12.20	390 / 15.35	390 / 15.35	350 / 13.78	
Interior volume	l / cu.ft.	62 / 2.19	62 / 2.19	55 / 1.94	118 / 4.17	118 / 4.17	106 / 3.74	
Steam space volume	l / cu.ft.	62 / 2.19	62 / 2.19	62 / 2.19	118 / 4.17	118 / 4.17	118 / 4.17	
<b>Racks</b>								
Quantity of racks (regular)		1	1	1	1	1	1	
Quantity of racks (max.)		3	3	3	5	5	5	
Max. load per rack	Kg / lbs	15 / 33	15 / 33	15 / 33	20 / 44	20 / 44	20 / 44	
Permitted total load	Kg / lbs	45 / 99	45 / 99	45 / 99	75 / 165	75 / 165	75 / 165	
<b>Weight</b>								
Weight (empty)	Kg / lbs	35 / 77	36 / 79	35 / 77	47 / 104	50 / 110	48 / 106	
<b>Temperature data</b>								
Temperature range	from ... degrees above ambient	°C / °F	5 / 9	7 / 12.6	14 / 25.2	5 / 9	7 / 12.6	14 / 25.2
	up to	°C / °F	70 / 158	250 / 482	250 / 482	70 / 158	250 / 482	250 / 482
Temperature fluctuation at 37 °C / 98.6 °F	+/- K	0.3	--	--	0.3	--	--	
Temperature fluctuation at 50 °C / 122 °F	+/- K	--	0.3	--	--	0.3	--	
Temperature fluctuation at 150 °C / 302 °F	+/- K	--	0.7	0.4	--	0.9	0.4	
Temperature fluctuation at 250 °C / 482 °F	+/- K	--	1.3	--	--	1.7	--	

Model		BD-S BD-S-UL	ED-S ED-S-UL	FD-S FD-S-UL	BD-S BD-S-UL	ED-S ED-S-UL	FD-S FD-S-UL
<b>Chamber size</b>		<b>56</b>	<b>56</b>	<b>56</b>	<b>115</b>	<b>115</b>	<b>115</b>
<b>Temperature data (continued)</b>							
Temperature uniformity (variation) at 37 °C / 98.6 °F	+/- K	0.5	--	--	0.6	--	--
Temperature uniformity (variation) at 150 °C / 302 °F	+/- K	--	3.4	2.6	--	2.8	2.0
Heating up time to 150 °C / 302 °F	minutes	--	60	15	--	55	20
Heating up time to 250 °C / 482 °F	minutes	--	75	--	--	75	--
Recovery time after door was opened for 30 sec at 37 °C / 98.6 °F	minutes	15	--	--	15	--	--
Recovery time after door was opened for 30 sec at 150 °C / 302 °F	minutes	--	45	5	--	40	8
<b>Ventilation data</b>							
Air change	x/h	--	--	4	--	--	2
<b>Electrical data (model versions BD-S056-230V, BD-S115-230V, ED-S056-230V, ED-S115-230V, FD-S056-230V, FD-S115-230V)</b>							
System of housing protection acc. to EN 60529	IP	20	20	20	20	20	20
Nominal voltage (+/-10%) at 50 Hz power frequency	V	230	230	230	230	230	230
Nominal voltage (+/-10%) at 60 Hz power frequency	V	230	230	230	230	230	230
Current type		1N~	1N~	1N~	1N~	1N~	1N~
Nominal power	kW	0,30	1,05	1,10	0,35	1,25	1,30
Power plug of the power cable		Grounded plug					
Chamber fuse (external) 5x20 mm / 250V / time-lag (T)	A	6,3	6,3	6,3	6,3	6,3	6,3
Overtemperature protective device class 1	°C °F	90 / 194	318 / 604.4	318 / 604.4	90 / 194	318 / 604.4	318 / 604.4
Installation category acc. to IEC 61010-1		II	II	II	II	II	II
Pollution degree acc. to IEC 61010-1		2	2	2	2	2	2
<b>Different electrical data for UL chambers constructed for the USA and Canada (model versions BD-S056UL-120V, BD-S115UL-120V, ED-S056UL-120V, ED-S115UL-120V, FD-S056UL-120V, FD-S115UL-120V)</b>							
Nominal voltage (+/-10%) at 50 Hz power frequency	V	120	120	120	120	120	120
Nominal voltage (+/-10%) at 60 Hz power frequency	V	120	120	120	120	120	120
Nominal power	kW	0,30	1,15	1,20	0,35	1,35	1,40
Power plug of the power cable	NEMA	5-15P	5-15P	5-15P	5-15P	5-15P	5-15P
Chamber fuse (external) 5x20 mm / 250V / time-lag (T)	A	12,5	12,5	12,5	12,5	12,5	12,5
<b>Environment-specific data</b>							
Noise level (mean value)	dB (A)	--	--	43	--	--	43
Energy consumption at 37 °C / 98.6 °F	Wh/h	25	--	--	30	--	--
Energy consumption at 150 °C / 302 °F	Wh/h	--	210	290	--	300	340

All technical data is specified for unloaded chambers with standard equipment at an ambient temperature of +22 °C +/- 3°C / 71.6 °F +/- 5.4 °F and a power supply voltage fluctuation of +/-10%. Technical data is determined in accordance to BINDER Factory Standard Part 2:2015 and DIN 12880:2007.

**All indications are average values, typical for chambers produced in series. We reserve the right to change technical specifications at any time.**



If the chamber is fully loaded, the specified heating up times may vary according to the load.

## 14.5 Equipment and options (extract)



To operate the chamber, use only original BINDER accessories or accessories / components from third-party suppliers authorized by BINDER. The user is responsible for any risk arising from using unauthorized accessories.

Standard equipment
R-S microprocessor temperature controller
Timer function "Delayed Off"
<i>BD-S / BD-S-UL</i> : Temperature safety controller class 3.1 acc. to DIN 12880:2007 with visual alarm
<i>ED-S / ED-S-UL, FD-S / FD-S-UL</i> : Temperature safety controller class 2 acc. to DIN 12880:2007 with visual alarm
<i>BD-S / BD-S-UL</i> : Inner glass door
Exhaust air outlet, internal diameter 50 mm / 1.97 inches, with exhaust air flap
Adjustable air change via exhaust air outlet
1 rack, chrome-plated, with 4 rack supports

Options / accessories
Rack, chrome-plated
Neutral cleaning agent (liquid concentrate)
Stable table on wheels with castors and locking brakes

## 14.6 Accessories and spare parts (extract)



BINDER GmbH is responsible for the safety features of the chamber only, provided skilled electricians or qualified personnel authorized by BINDER perform all maintenance and repair, and if components relating to chamber safety are replaced in the event of failure with original spare parts. The user is responsible for any risks arising from using unauthorized accessories/components.

Chamber size	56	115
Description	Art. No.	
Rack, chrome-plated	6004-0209	6004-0210
Door gasket, silicone	6005-0287	6005-0288
Stable table on wheels with castors and locking brakes	9051-0005	
Chamber fuse 5x20mm 250V 6,3 A time lag (T)	5006-0092	
Chamber fuse 5x20mm 250V 12,5 A time lag (T) for UL chambers	5006-0096	
4 rack supports	8012-1879	
Neutral cleaning agent, 1 kg	1002-0016	

For information on components not listed here, please contact BINDER Service.

## 14.7 Dimensioned drawings

### 14.7.1 BD-S / BD-S-UL 56

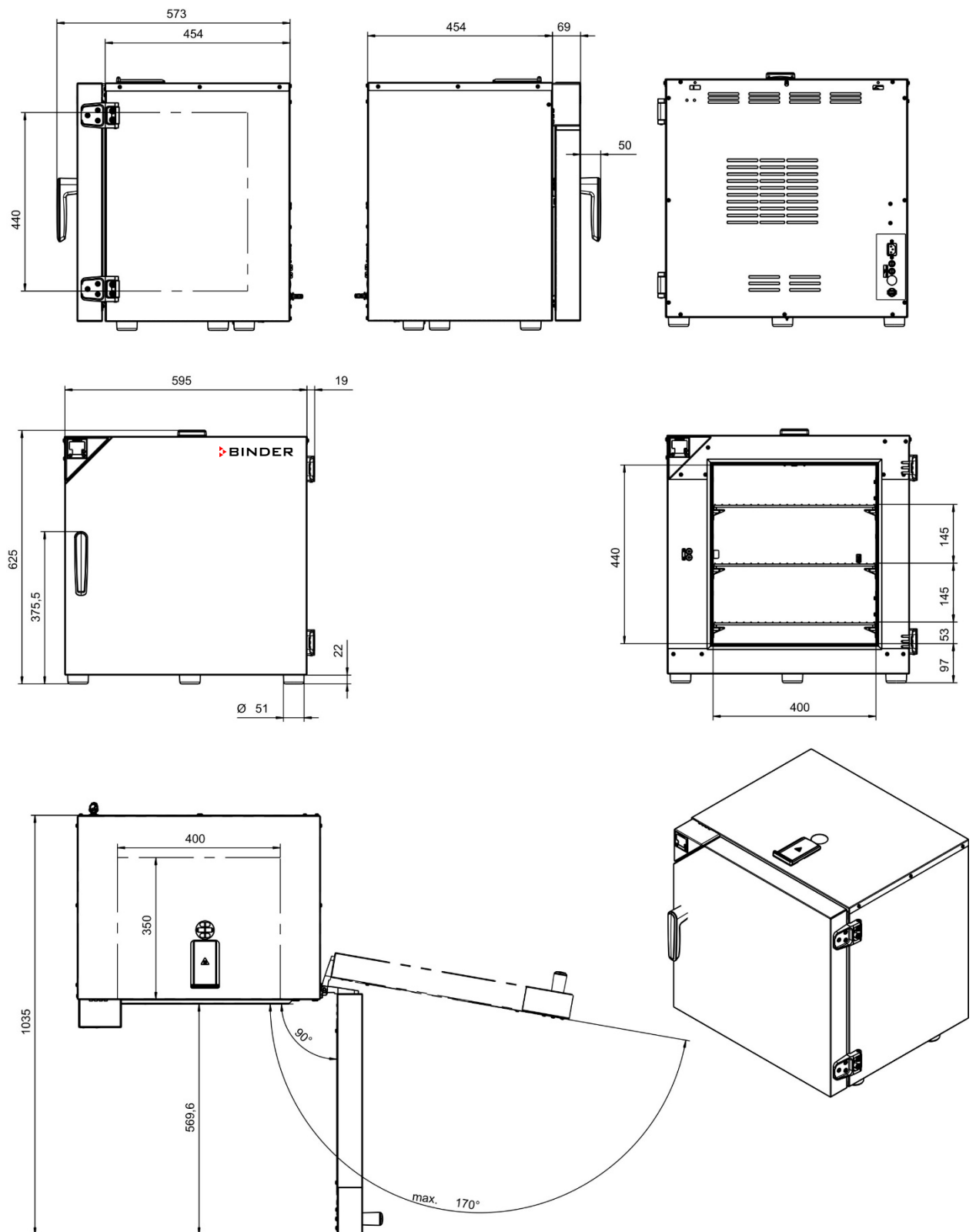

[mm]

### 14.7.2 BD-S / BD-S-UL 115

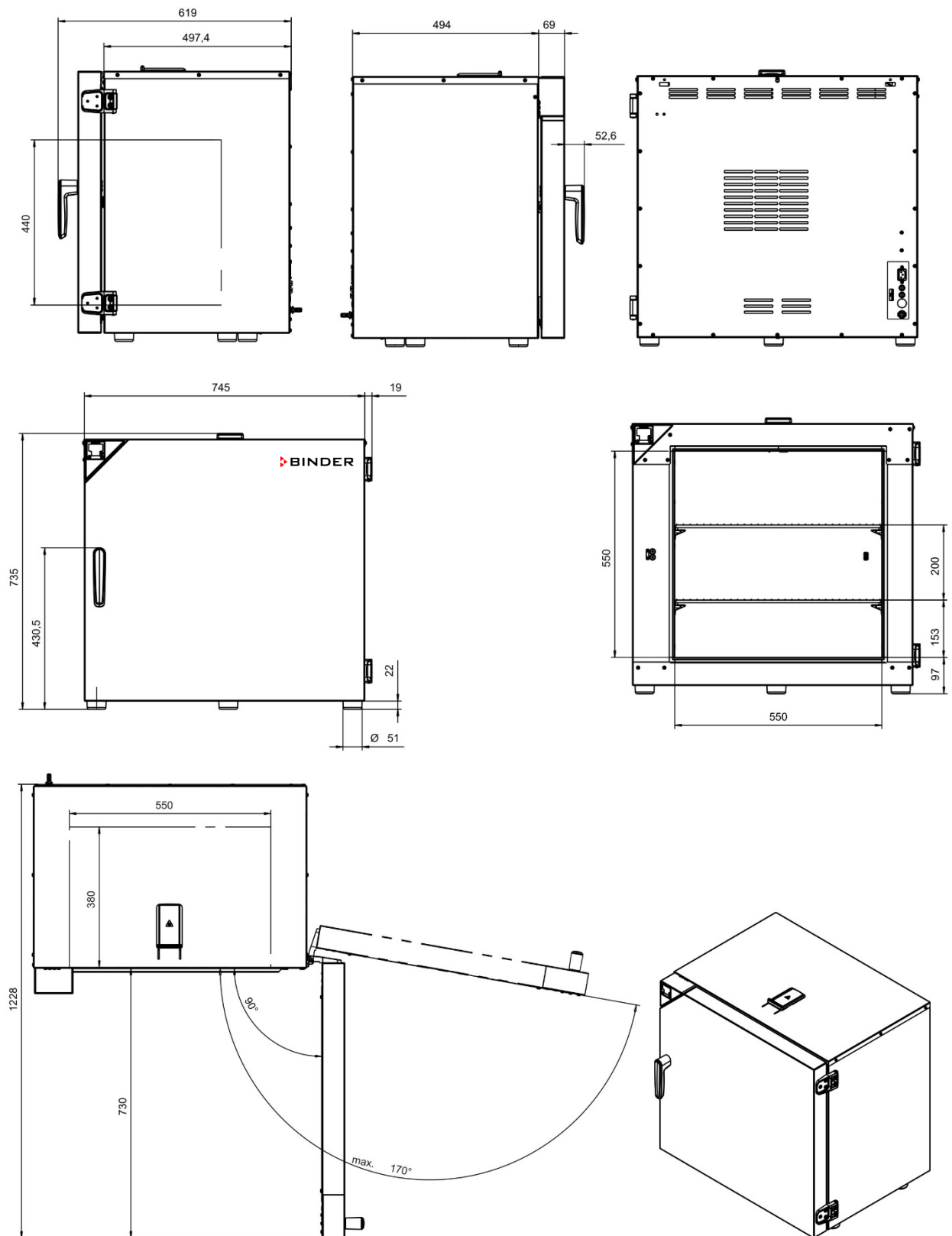

[mm]

### 14.7.3 ED-S / ED-S-UL 56

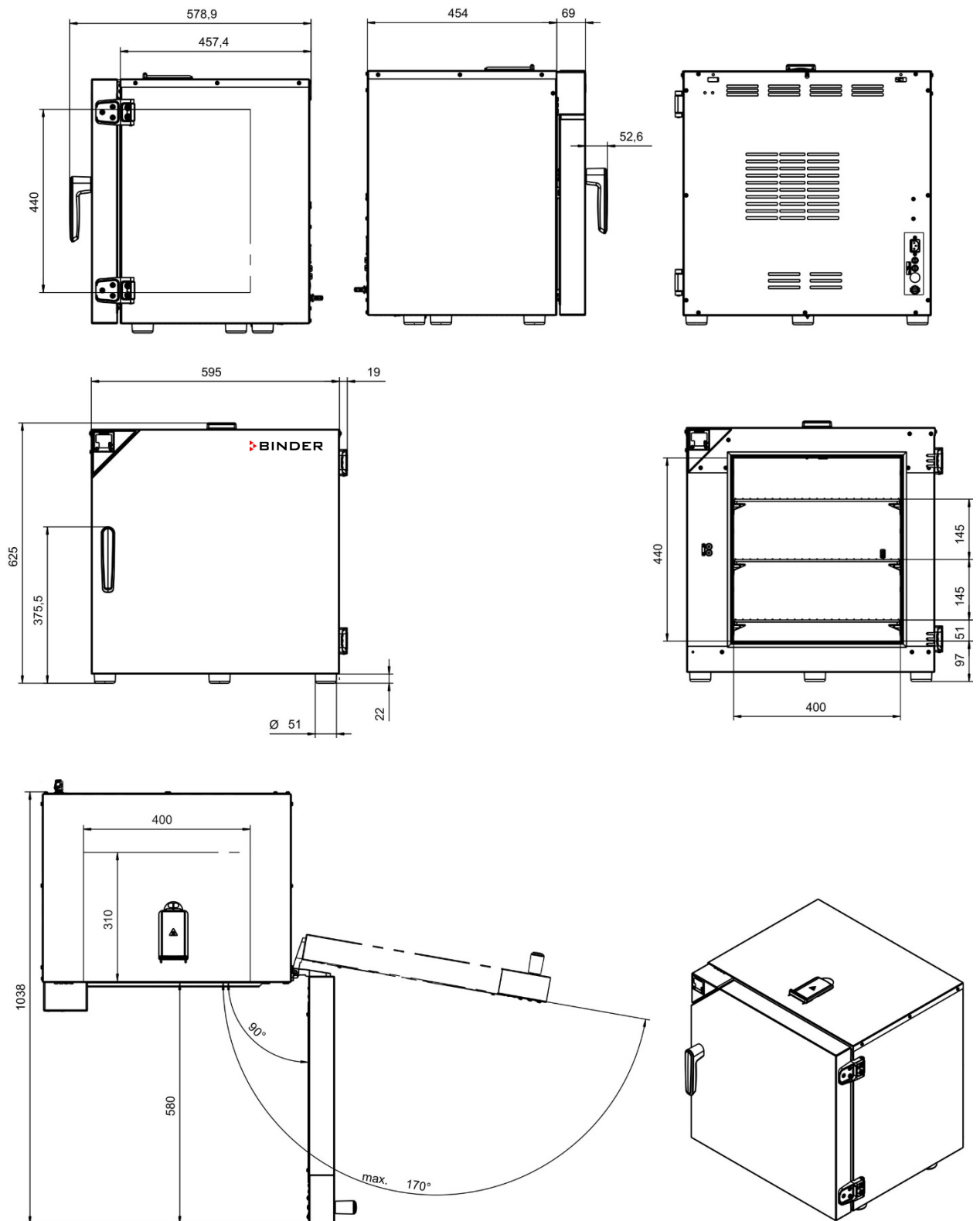

[mm]



### 14.7.4 ED-S / ED-S-UL 115

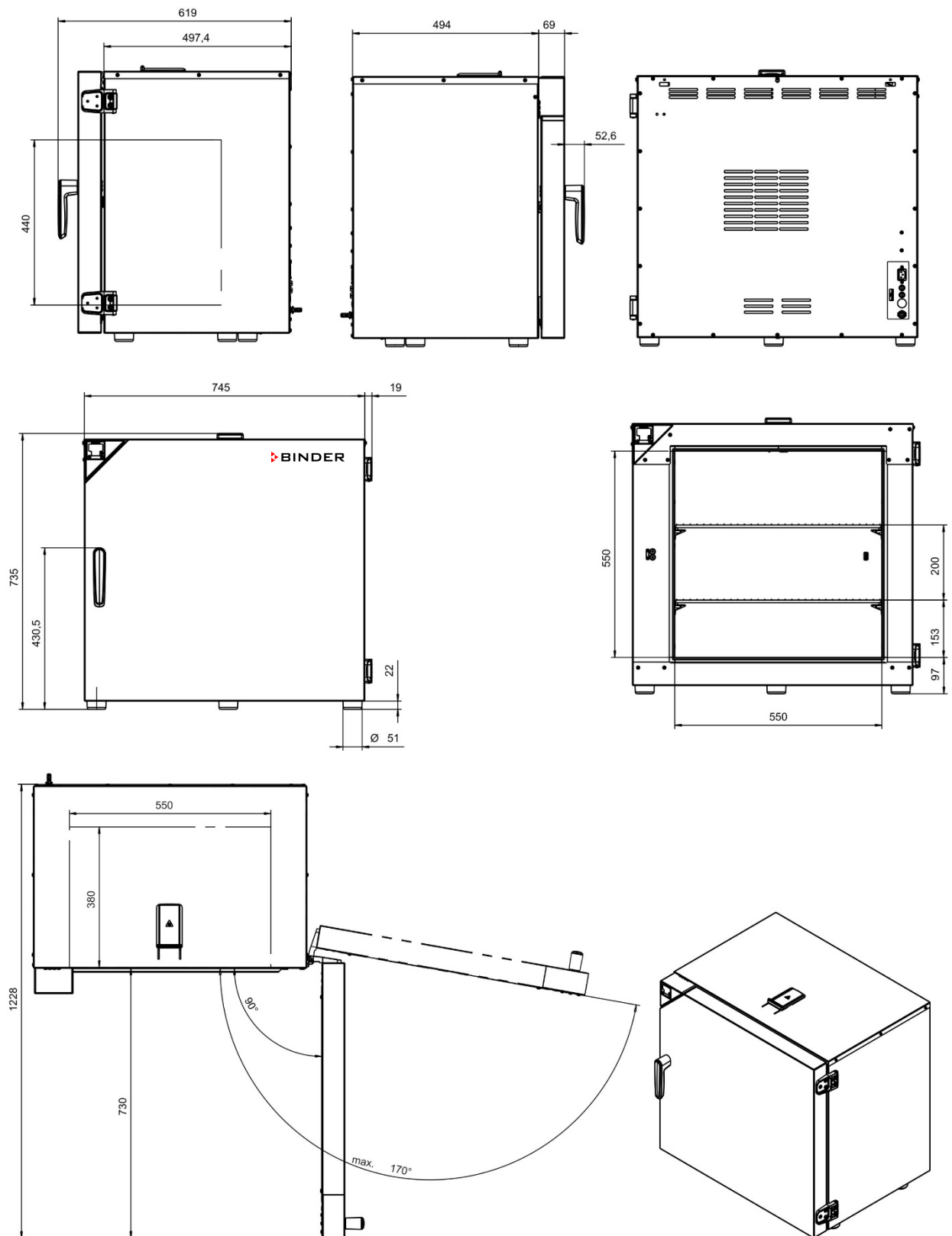

[mm]

### 14.7.5 FD-S / FD-S-UL 56

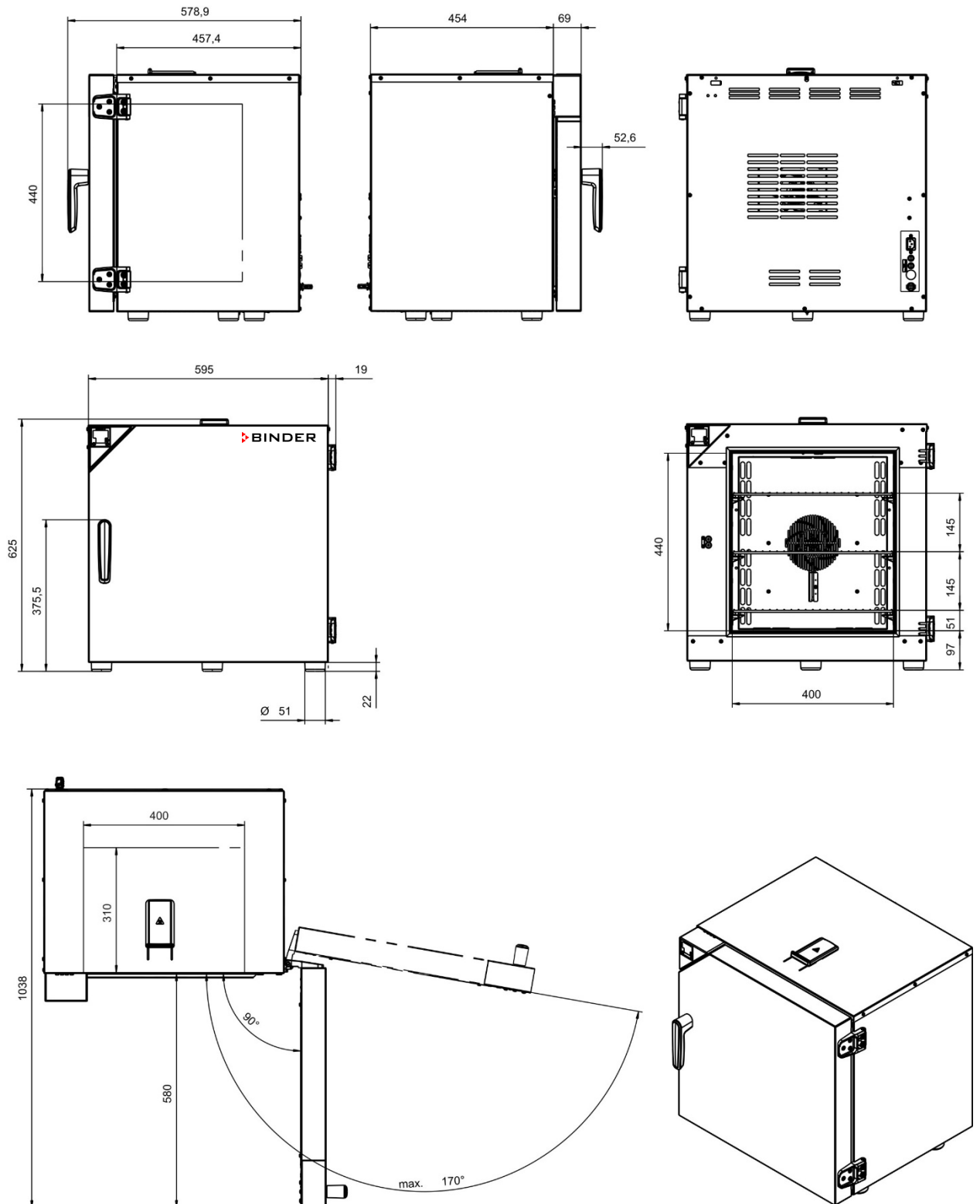

[mm]

### 14.7.6 FD-S / FD-S-UL 115

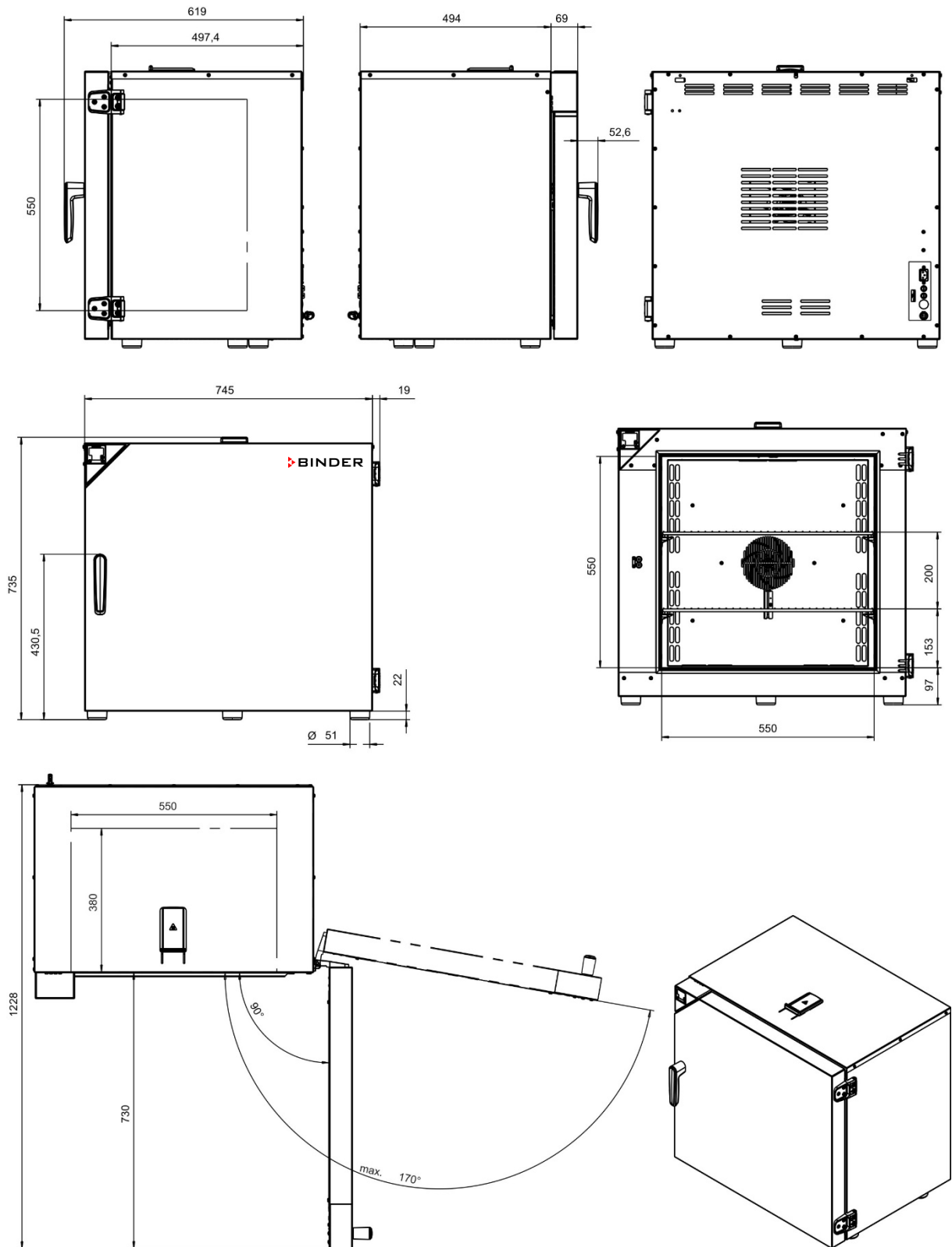

[mm]

## 15. Certificates and declarations of conformity

### 15.1 EU Declaration of Conformity for BD-S

**CE** EU-Konformitätserklärung / EU Declaration of Conformity / Déclaration de conformité UE / Declaración de conformidad UE / Dichiarazione di conformità UE / Декларация соответствия EU

Hersteller / Manufacturer / Fabricant / Fabricante / Fabbicante / Производитель	BINDER GmbH
Anschrift / Address / Adresse / Dirección / Indirizzo / Адрес	Im Mittleren Ösch 5, 78532 Tuttlingen, Germany
Produkt / Product / Produit / Producto / Prodotto / Продукт	Inkubatoren mit freier Konvektion Incubators with natural convection Incubateurs à convection naturelle Incubadoras de convección natural Incubatori a convezione naturale Инкубаторы с естественной конвекцией
Typenbezeichnung / Type / Type / Tipo / Tipo / Тип	BD-S 56, BD-S 115,
Art. No. / Art. no. / Réf. / Art. N° / Art. n. / № арт.	9090-0016, 9190-0016, 9090-0022, 9190-0022

Die oben beschriebenen Produkte sind konform mit folgenden EU-Richtlinien:

The products described above are in conformity with the following EU Directives:

Les produits décrits ci-dessus sont conformes aux directives UE suivantes:

Los productos descritos arriba cumplen con las siguientes directivas de la UE:

I prodotti sopra descritti sono conformi alle seguenti direttive UE:

Продукты, указанные выше, полностью соответствуют следующим EU руководствам:

- 2014/35/EU**  
 Niederspannungsrichtlinie 2014/35/EU / Low voltage directive 2014/35/EU / Directive basse tension 2014/35/UE / Directiva sobre baja tensión 2014/35/UE / Direttiva Bassa tensione 2014/35/UE / Директива по низкому напряжению 2014/35/EU
- 2014/30/EU**  
 EMV-Richtlinie 2014/30/EU / EMC Directive 2014/30/EU / Directive CEM 2014/30/UE / Directiva CEM 2014/30/UE / Direttiva EMC 2014/30/UE / Директива ЭМС 2014/30/EU
- 2011/65/EU, (EU) 2015/863**  
 RoHS-Richtlinien 2011/65/EU und (EU) 2015/863 / RoHS Directives 2011/65/EU and (EU) 2015/863 / Directives RoHS 2011/65/UE et (UE) 2015/863 / Directivas RoHS 2011/65/UE y (UE) 2015/863 / Direttive RoHS 2011/65/UE et (UE) 2015/863 / Директивы RoHS 2011/65/EU и (EU) 2015/863

1 / 2

Die oben beschriebenen Produkte tragen entsprechend die Kennzeichnung CE.  
The products described above, corresponding to this, bear the CE-mark.  
Les produits décrits ci-dessus, en correspondance, portent l'indication CE.  
Los productos descritos arriba, en conformidad, llevan la indicación CE.  
I prodotti sopra descritti, conformi a quanto sopra, portano il marchio CE.  
Данные продукты в соответствии с изложенным выше маркированы знаком CE.

Die oben beschriebenen Produkte sind konform mit folgenden harmonisierten Normen:  
The products described above are in conformity with the following harmonized standards:  
Les produits décrits ci-dessus sont conformes aux normes harmonisées suivantes:  
Los productos descritos arriba cumplen con las siguientes normas:  
I prodotti sopra descritti sono conformi alle seguenti normative armonizzate:  
Продукты, указанные выше, полностью соответствуют следующим стандартам:

Sicherheit / Safety / Sécurité / Seguridad / Sicurezza / Нормативы по безопасности
<ul style="list-style-type: none"><li>• EN 61010-1:2010</li><li>• EN 61010-2-010:2014</li><li>• EN 60204-1:2018</li></ul>
EMV / EMC / CEM / CEM / EMC / ЭМС
<ul style="list-style-type: none"><li>• EN 61326-1:2013</li></ul>
RoHS
<ul style="list-style-type: none"><li>• EN IEC 63000:2018</li></ul>

78532 Tuttlingen, 21.09.2021

BINDER GmbH



P. Wimmer

Vice President

Vice President

Vice président

Vicepresidente

vicepresidente

Вице-президент



J. Bollaender

Leiter F & E

Director R & D

Chef de service R&D

Responsable I & D

Direttore R & D

Глава департамента R&D

2 / 2

BINDER GmbH Postfach 102 D-78502 Tuttlingen **Anschrift:** BINDER GmbH Im Mittleren Ösch 5 D-78532 Tuttlingen  
**Kontakt:** Telefon: +49 (0) 74 62 / 20 05 – 0 | Telefax: +49 (0) 74 62 / 20 05 – 100 | info@binder-world.com | www.binder-world.com  
**Geschäftsführung:** Dipl.-Ing. Peter M. Binder | Amtsgericht Stuttgart, HRB 727150 | Sitz der Gesellschaft: Tuttlingen  
**Bankverbindung:** Kreissparkasse Tuttlingen | IBAN-Code: DE05 6435 0070 0000 0022 66 | SWIFT-Code: SOLA DE 31TUT  
\$-IBAN-Code: DE90 6435 0070 0220 2639 71 | SWIFT-Code: SOLA DE 31TUT  
Deutsche Bank Tuttlingen | IBAN-Code: DE56 6537 0075 0213 8709 00 | SWIFT-Code: DEUT DE 55653  
Altgeräte-Entsorgung gemäß WEEE-Reg.-Nr. DE 37004983



## 15.2 EU Declaration of Conformity for ED-S



**CE** EU-Konformitätserklärung / EU Declaration of Conformity / Déclaration de conformité UE / Declaración de conformidad UE / Dichiarazione di conformità UE / Декларация соответствия EU

Hersteller / Manufacturer / Fabricant / Fabricante / Fabbicante / Производитель	BINDER GmbH
Anschrift / Address / Adresse / Dirección / Indirizzo / Адрес	Im Mittleren Ösch 5, 78532 Tuttlingen, Germany
Produkt / Product / Produit / Producto / Prodotto / Продукт	Trocken- und Wärmeschränke mit freier Konvektion Drying and heating ovens with natural convection Etuves de chauffage et de séchage à convection naturelle Estufas de secado y calentamiento de convección natural Stufe per essiccazione e riscaldamento a convezione naturale Сушильные и сухожаровые шкафы с естественной конвекцией
Typenbezeichnung / Type / Type / Tipo / Tipo / Тип	ED-S 56, ED-S 115 (E1)
Art. No. / Art. no. / Réf. / Art. N° / Art. n. / № арт.	9090-0014, 9190-0014, 9090-0020, 9190-0020

Die oben beschriebenen Produkte sind konform mit folgenden EU-Richtlinien:

The products described above are in conformity with the following EU Directives:

Les produits décrits ci-dessus sont conformes aux directives UE suivantes:

Los productos descritos arriba cumplen con las siguientes directivas de la UE:

I prodotti sopra descritti sono conformi alle seguenti direttive UE:

Продукты, указанные выше, полностью соответствуют следующим EU руководствам:

- **2014/35/EU**  
Niederspannungsrichtlinie 2014/35/EU / Low voltage directive 2014/35/EU / Directive basse tension 2014/35/UE / Directiva sobre baja tensión 2014/35/UE / Direttiva Bassa tensione 2014/35/UE / Директива по низкому напряжению 2014/35/EU
- **2014/30/EU**  
EMV-Richtlinie 2014/30/EU / EMC Directive 2014/30/EU / Directive CEM 2014/30/UE / Directiva CEM 2014/30/UE / Direttiva EMC 2014/30/UE / Директива ЭМС 2014/30/EU
- **2011/65/EU, (EU) 2015/863**  
RoHS-Richtlinien 2011/65/EU und (EU) 2015/863 / RoHS Directives 2011/65/EU and (EU) 2015/863 / Directives RoHS 2011/65/UE et (UE) 2015/863 / Directivas RoHS 2011/65/UE y (UE) 2015/863 / Direttive RoHS 2011/65/UE et (UE) 2015/863 / Директивы RoHS 2011/65/EU и (EU) 2015/863

1 / 2

BINDER GmbH Postfach 102 D-78502 Tuttlingen **Anschrift:** BINDER GmbH Im Mittleren Ösch 5 D-78532 Tuttlingen  
**Kontakt:** Telefon: +49 (0) 74 62 / 20 05 – 0 | Telefax: +49 (0) 74 62 / 20 05 – 100 | info@binder-world.com | www.binder-world.com  
**Geschäftsführung:** Dipl.-Ing. Peter M. Binder | Amtsgericht Stuttgart, HRB 727150 | Sitz der Gesellschaft: Tuttlingen  
**Bankverbindung:** Kreissparkasse Tuttlingen | IBAN-Code: DE05 6435 0070 0000 0022 66 | SWIFT-Code: SOLA DE 3303  
 \$-IBAN-Code: DE90 6435 0070 0220 2639 71 | SWIFT-Code: SOLA DE 3303  
 Deutsche Bank Tuttlingen | IBAN-Code: DE56 6537 0075 0213 8709 00 | SWIFT-Code: DEUT DE 3303  
 Altgeräte-Entsorgung gemäß WEEE-Reg.-Nr. DE 37004983

Die oben beschriebenen Produkte tragen entsprechend die Kennzeichnung CE.  
The products described above, corresponding to this, bear the CE-mark.  
Les produits décrits ci-dessus, en correspondance, portent l'indication CE.  
Los productos descritos arriba, en conformidad, llevan la indicación CE.  
I prodotti sopra descritti, conformi a quanto sopra, portano il marchio CE.  
Данные продукты в соответствии с изложенным выше маркированы знаком CE.

Die oben beschriebenen Produkte sind konform mit folgenden harmonisierten Normen:  
The products described above are in conformity with the following harmonized standards:  
Les produits décrits ci-dessus sont conformes aux normes harmonisées suivantes:  
Los productos descritos arriba cumplen con las siguientes normas:  
I prodotti sopra descritti sono conformi alle seguenti normative armonizzate:  
Продукты, указанные выше, полностью соответствуют следующим стандартам:

Sicherheit / Safety / Sécurité / Seguridad / Sicurezza / Нормативы по безопасности
<ul style="list-style-type: none"><li>• EN 61010-1:2010</li><li>• EN 61010-2-010:2014</li><li>• EN 60204-1:2018</li></ul>
EMV / EMC / CEM / CEM / EMC / ЭМС
<ul style="list-style-type: none"><li>• EN 61326-1:2013</li></ul>
RoHS
<ul style="list-style-type: none"><li>• EN IEC 63000:2018</li></ul>

78532 Tuttlingen, 21.09.2021

BINDER GmbH



P. Wimmer

Vice President

Vice President

Vice président

Vicepresidente

vicepresidente

Вице-президент



J. Bollaender

Leiter F & E

Director R & D

Chef de service R&D

Responsable I & D

Direttore R & D

Глава департамента R&D

2 / 2

BINDER GmbH Postfach 102 D-78502 Tuttlingen **Anschrift:** BINDER GmbH im Mittleren Ösch 5 D-78532 Tuttlingen  
**Kontakt:** Telefon: +49 (0) 74 62 / 20 05 – 0 | Telefax: +49 (0) 74 62 / 20 05 – 100 | info@binder-world.com | www.binder-world.com  
**Geschäftsführung:** Dipl.-Ing. Peter M. Binder | Amtsgericht Stuttgart, HRB 727150 | Sitz der Gesellschaft: Tuttlingen  
**Bankverbindung:** Kreissparkasse Tuttlingen | IBAN-Code: DE05 6435 0070 0000 0022 66 | SWIFT-Code: SOLA DE 51TUT  
\$-IBAN-Code: DE90 6435 0070 0220 2639 71 | SWIFT-Code: SOLA DE 51TUT  
Deutsche Bank Tuttlingen | IBAN-Code: DE56 6537 0075 0213 8709 00 | SWIFT-Code: DEUT DE 55653  
Altgeräte-Entsorgung gemäß WEEE-Reg.-Nr. DE 37004983

### 15.3 EU Declaration of Conformity for FD-S



**CE** EU-Konformitätserklärung / EU Declaration of Conformity / Déclaration de conformité UE / Declaración de conformidad UE / Dichiarazione di conformità UE / Декларация соответствия EU

Hersteller / Manufacturer / Fabricant / Fabricante / Fabbicante / Производитель	BINDER GmbH
Anschrift / Address / Adresse / Dirección / Indirizzo / Адрес	Im Mittleren Ösch 5, 78532 Tuttlingen, Germany
Produkt / Product / Produit / Producto / Prodotto / Продукт	Trocken- und Wärmeschränke mit Umluft Drying and heating ovens with forced convection Etuves de chauffage et de séchage à convection forcée Estufas de secado y calentamiento de convección forzada Stufe per essiccazione e riscaldamento a convezione forzata Сушильные и сухожаровые шкафы с принудительной конвекцией
Typenbezeichnung / Type / Type / Tipo / Tipo / Тип	FD-S 56, FD-S 115 (E1)
Art. No. / Art. no. / Réf. / Art. N° / Art. n. / № арт.	9090-0018, 9190-0018, 9090-0024, 9190-0024

Die oben beschriebenen Produkte sind konform mit folgenden EU-Richtlinien:

The products described above are in conformity with the following EU Directives:

Les produits décrits ci-dessus sont conformes aux directives UE suivantes:

Los productos descritos arriba cumplen con las siguientes directivas de la UE:

I prodotti sopra descritti sono conformi alle seguenti direttive UE:

Продукты, указанные выше, полностью соответствуют следующим EU руководствам:

- **2014/35/EU**  
Niederspannungsrichtlinie 2014/35/EU / Low voltage directive 2014/35/EU / Directive basse tension 2014/35/UE / Directiva sobre baja tensión 2014/35/UE / Direttiva Bassa tensione 2014/35/UE / Директива по низкому напряжению 2014/35/EU
- **2014/30/EU**  
EMV-Richtlinie 2014/30/EU / EMC Directive 2014/30/EU / Directive CEM 2014/30/UE / Directiva CEM 2014/30/UE / Direttiva EMC 2014/30/UE / Директива ЭМС 2014/30/EU
- **2011/65/EU, (EU) 2015/863**  
RoHS-Richtlinien 2011/65/EU und (EU) 2015/863 / RoHS Directives 2011/65/EU and (EU) 2015/863 / Directives RoHS 2011/65/UE et (UE) 2015/863 / Directivas RoHS 2011/65/UE y (UE) 2015/863 / Direttive RoHS 2011/65/UE et (UE) 2015/863 / Директивы RoHS 2011/65/EU и (EU) 2015/863

1 / 2

BINDER GmbH Postfach 102 D-78502 Tuttlingen **Anschrift:** BINDER GmbH Im Mittleren Ösch 5 D-78532 Tuttlingen  
**Kontakt:** Telefon: +49 (0) 74 62 / 20 05 – 0 | Telefax: +49 (0) 74 62 / 20 05 – 100 | info@binder-world.com | www.binder-world.com  
**Geschäftsführung:** Dipl.-Ing. Peter M. Binder | Amtsgericht Stuttgart, HRB 727150 | Sitz der Gesellschaft: Tuttlingen  
**Bankverbindung:** Kreissparkasse Tuttlingen | IBAN-Code: DE05 6435 0070 0000 0022 66 | SWIFT-Code: SOLA DE 51TUT  
 \$-IBAN-Code: DE90 6435 0070 0220 2639 71 | SWIFT-Code: SOLA DE 51TUT  
 Deutsche Bank Tuttlingen | IBAN-Code: DE56 6537 0075 0213 8709 00 | SWIFT-Code: DEUT DE 55653  
 Altgeräte-Entsorgung gemäß WEEE-Reg.-Nr. DE 37004983



Die oben beschriebenen Produkte tragen entsprechend die Kennzeichnung CE.  
The products described above, corresponding to this, bear the CE-mark.  
Les produits décrits ci-dessus, en correspondance, portent l'indication CE.  
Los productos descritos arriba, en conformidad, llevan la indicación CE.  
I prodotti sopra descritti, conformi a quanto sopra, portano il marchio CE.  
Данные продукты в соответствии с изложенным выше маркированы знаком CE.

Die oben beschriebenen Produkte sind konform mit folgenden harmonisierten Normen:  
The products described above are in conformity with the following harmonized standards:  
Les produits décrits ci-dessus sont conformes aux normes harmonisées suivantes:  
Los productos descritos arriba cumplen con las siguientes normas:  
I prodotti sopra descritti sono conformi alle seguenti normative armonizzate:  
Продукты, указанные выше, полностью соответствуют следующим стандартам:

Sicherheit / Safety / Sécurité / Seguridad / Sicurezza / Нормативы по безопасности
<ul style="list-style-type: none"><li>• EN 61010-1:2010</li><li>• EN 61010-2-010:2014</li><li>• EN 60204-1:2018</li></ul>
EMV / EMC / CEM / CEM / EMC / ЭМС
<ul style="list-style-type: none"><li>• EN 61326-1:2013</li></ul>
RoHS
<ul style="list-style-type: none"><li>• EN IEC 63000:2018</li></ul>

78532 Tuttlingen, 21.09.2021

BINDER GmbH



P. Wimmer

Vice President

Vice President

Vice président

Vicepresidente

vicepresidente

Вице-президент



J. Bollaender

Leiter F & E

Director R & D

Chef de service R&D

Responsable I & D

Direttore R & D

Глава департамента R&D

2 / 2

BINDER GmbH Postfach 102 D-78502 Tuttlingen **Anschrift:** BINDER GmbH im Mittleren Ösch 5 D-78532 Tuttlingen  
**Kontakt:** Telefon: +49 (0) 74 62 / 20 05 – 0 | Telefax: +49 (0) 74 62 / 20 05 – 100 | info@binder-world.com | www.binder-world.com  
**Geschäftsführung:** Dipl.-Ing. Peter M. Binder | Amtsgericht Stuttgart, HRB 727150 | Sitz der Gesellschaft: Tuttlingen  
**Bankverbindung:** Kreissparkasse Tuttlingen | IBAN-Code: DE05 6435 0070 0000 0022 66 | SWIFT-Code: SOLA DE 51TUT  
\$-IBAN-Code: DE90 6435 0070 0220 2639 71 | SWIFT-Code: SOLA DE 51TUT  
Deutsche Bank Tuttlingen | IBAN-Code: DE56 6537 0075 0213 8709 00 | SWIFT-Code: DEUT DE 55653  
Altgeräte-Entsorgung gemäß WEEE-Reg.-Nr. DE 37004983

15.4 Certificate for the GS mark of conformity of the “VDE Prüf- und Zertifizierungsinstitut” (Testing and Certification Institute of the Association for Electrical, Electronic and Information Technologies)

# VDE Prüf- und Zertifizierungsinstitut

## ZEICHENGENEHMIGUNG MARKS APPROVAL

**Binder GmbH**  
Im Mittleren Ösch 5  
78532 Tuttlingen

ist berechtigt, für ihr Produkt /  
*is authorized to use for their product*

**Wärmeschrank, Labor**  
*Heating cabinet, laboratory*

die hier abgebildeten markenrechtlich geschützten Zeichen  
für die ab Blatt 2 aufgeführten Typen zu benutzen /  
*the legally protected Marks as shown below for the types referred to on page 2 ff.*

und/oder - and/or

oder/ or

Geprüft und zertifiziert nach /  
*Tested and certified according to*

DIN EN 61010-1 (VDE 0411 Teil 1):2011-07; EN 61010-1:2010-10  
DIN EN 61010-2-010 (VDE 0411-2-010):2015-05; EN 61010-2-010:2014  
IEC 61010-1:2010  
IEC 61010-2-010:2014

Das Produkt entspricht den Anforderungen des deutschen Produktsicherheitsgesetzes (ProdSG) hinsichtlich der Gewährleistung von Sicherheit und Gesundheit.  
*The product covers the requirements of the German Act "Produktsicherheitsgesetz (ProdSG)" regarding the ensurance of safety and health.*

Befristet zum / *valid until*: 2024-02-29

VDE Prüf- und Zertifizierungsinstitut GmbH  
*VDE Testing and Certification Institute*  
Zertifizierungsstelle / *Certification*

  
G. Heine

VDE Zertifikate sind nur gültig bei Veröffentlichung unter:  
VDE certificates are valid only when published on:

Aktenzeichen: 1792300-2945-0012 / 251016  
*File ref.:*

Ausweis-Nr. 40049830 Blatt 1  
*Certificate No.* Page

Weitere Bedingungen siehe Rückseite und Folgeblätter /  
further conditions see overleaf and following pages

Offenbach, 2019-03-27

<http://www.vde.com/zertifikat>  
<http://www.vde.com/certificate>



## VDE Prüf- und Zertifizierungsinstitut Zeichengenehmigung

Ausweis-Nr. / Blatt /  
Certificate No. / Page  
40049830 / 2

Name und Sitz des Genehmigungs-Inhabers / *Name and registered seat of the Certificate holder*  
Binder GmbH, Im Mittleren Ösch 5, 78532 Tuttlingen

Aktenzeichen / *File ref.*  
1792300-2945-0012 / 251016 / TL4 / ZIE

Datum / *Date*  
2019-03-27

Dieses Blatt gilt nur in Verbindung mit Blatt 1 des Zeichengenehmigungsausweises Nr. 40049830.  
*This supplement is only valid in conjunction with page 1 of the Certificate No. 40049830.*

### **Wärmeschrank, Labor** ***Heating cabinet, laboratory***

Typ(en) / *Type(s)*

**BD-S 056**  
**ED-S 056**  
**FD-S 056**  
**BD-S 115**  
**ED-S 115**  
**FD-S 115**

PAK AfPS GS 2014:01PAK  
*PAH AfPS GS 2014:01PAH*

Das Produkt entspricht den Anforderungen gemäß  
PAK-Dokument AfPS GS 2014:01PAK.  
*The product is in accordance with the requirements of  
PAH-document AfPS GS 2014:01PAH.*

Weitere Angaben  
*Further information*

siehe Anlage Nr. 1 / 2019-03-27  
*see attachment No. 1 / 2019-03-27*

VDE Prüf- und Zertifizierungsinstitut GmbH  
*VDE Testing and Certification Institute*  
Fachgebiet TL4  
*Section TL4*

VDE Prüf- und Zertifizierungsinstitut GmbH \* Testing and Certification Institute



Menianstrasse 28, D-63069 Offenbach

Telefon +49 (0) 69 83 08-0  
Telefax +49 (0) 69 83 08-555



## VDE Prüf- und Zertifizierungsinstitut Zeichengenehmigung

Ausweis-Nr. / Infoblatt /  
Certificate No. / Info sheet  
40049830

Name und Sitz des Genehmigungs-Inhabers / *Name and registered seat of the Certificate holder*  
Binder GmbH, Im Mittleren Ösch 5, 78532 Tuttlingen

Aktenzeichen / *File ref.*  
1792300-2945-0012 / 251016 / TL4 / ZIE

Datum / *Date*  
2019-03-27

Dieses Blatt gilt nur in Verbindung mit Blatt 1 des Zeichengenehmigungsausweises Nr. 40049830.  
*This supplement is only valid in conjunction with page 1 of the Certificate No. 40049830.*

### **Genehmigung zum Benutzen des auf Seite 1 abgebildeten markenrechtlich geschützten Zeichens des VDE:**

Grundlage für die Benutzung sind die Allgemeinen Geschäftsbedingungen (AGB) der VDE Prüf- und Zertifizierungsinstitut GmbH ([www.vde.com](http://www.vde.com)\AGB-Institut). Das Recht zur Benutzung erstreckt sich nur auf die bezeichnete Firma mit den genannten Fertigungsstätten und die oben aufgeführten Produkte mit den zugeordneten Bezeichnungen. Die Fertigungsstätte muss so eingerichtet sein, dass eine gleichmäßige Herstellung der geprüften und zertifizierten Ausführung gewährleistet ist.

Die Genehmigung ist so lange gültig wie die VDE-Bestimmungen gelten, die der Zertifizierung zugrunde gelegen haben, sofern sie nicht auf Grund anderer Bedingungen aus der VDE Prüf- und Zertifizierungsordnung (PM102) zurückgezogen werden muss.

Der Gültigkeitszeitraum einer VDE-GS-Zeichengenehmigung kann auf Antrag verlängert werden. Bei gesetzlichen und / oder normativen Änderungen kann die VDE-GS-Zeichengenehmigung ihre Gültigkeit zu einem früheren als dem angegebenen Datum verlieren.

Produkte, die das Biozid Dimethylfumarat (DMF) enthalten, dürfen gemäß der Kommissionsentscheidung 2009/251/EG nicht mehr in den Verkehr gebracht oder auf dem Markt bereitgestellt werden.

Der VDE-Zeichengenehmigungsausweis wird ausschließlich auf der ersten Seite unterzeichnet.

#### **Approval to use the legally protected Mark of the VDE as shown on the first page:**

*Basis for the use are the general terms and conditions of the VDE Testing and Certification Institute ([www.vde.com](http://www.vde.com)\terms-institute). The right to use the mark is granted only to the mentioned company with the named places of manufacture and the listed products with the related type references. The place of manufacture shall be equipped in a way that a constant manufacturing of the certified construction is assured.*

*The approval is valid as long as the VDE specifications are in force, on which the certification is based on, unless it is withdrawn according to the VDE Testing and Certification Procedure (PM102E).*

*The validity period of a VDE-GS-Mark Approval may be prolonged on request. In case of changes in legal and / or normative requirements, the validity period of a VDE-GS-Mark Approval may be shortened.*

*Products containing the biocide dimethylfumarate (DMF) may not be marketed or made available on the EC market according to the Commission Decision 2009/251/EC.*

*The approval is solely signed on the first page.*



## 15.5 Certificate of UL Compliance from Underwriters Laboratories Inc.®

Valid for UL chambers only

### CERTIFICATE OF COMPLIANCE

**Certificate Number** 20190319-E200795  
**Report Reference** E200795-20190314  
**Issue Date** 2019-MARCH-19

**Issued to:** BINDER GMBH  
IM MITTLEREN OESCH 5  
78532 TUTTLINGEN GERMANY

**This certificate confirms that  
representative samples of**

LABORATORY-USE ELECTRICAL EQUIPMENT  
Laboratory Ovens : BD-S 056-UL; ED-S 056-UL; FD-S 056-  
UL;  
BD-S 115-UL; ED-S 115-UL; FD-S 115-UL

Have been investigated by UL in accordance with the  
Standard(s) indicated on this Certificate.

**Standard(s) for Safety:** UL 61010-2-010 and CAN/CSA-C22.2 NO. 61010-2-010  
Particular Requirements for Laboratory Equipment for the  
Heating of Materials.

**Additional Information:** See the UL Online Certifications Directory at  
<https://iq.ulprospector.com> for additional information.

This *Certificate of Compliance* does not provide authorization to apply the UL Mark. Only the UL Follow-Up  
Services Procedure provides authorization to apply the UL Mark.

Only those products bearing the UL Mark should be considered as being UL Certified and covered under UL's  
Follow-Up Services.

Look for the UL Certification Mark on the product.

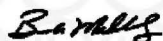

Bruce Mahrenholz, Director North American Certification Program  
UL LLC

Any information and documentation involving UL Mark services are provided on behalf of UL LLC (UL) or any authorized licensee of UL. For questions, please  
contact a local UL Customer Service Representative at <http://ul.com/about/locations>.



## 16. Contamination clearance certificate

### 16.1 For chambers located outside the USA and Canada

#### Declaration with regard to safety and health

Erklärung zur Sicherheit und gesundheitlichen Unbedenklichkeit

The German Ordinance on Hazardous Substances (GefStofV), and the regulations regarding safety at the workplace, require that this form be filled out for all products that are returned to us, so that the safety and health of our employees can be warranted.

Die Sicherheit und Gesundheit unserer Mitarbeiter, die Gefahrstoffverordnung GefStofV und die Vorschriften zur Sicherheit am Arbeitsplatz machen es erforderlich, dass dieses Formblatt für alle Produkte, die an uns zurückgeschickt wird.



In the absence of a completely filled out form, a repair is not possible.  
Ohne Vorliegen des vollständig ausgefüllten Formblattes ist eine Reparatur nicht möglich.

- A completely filled out form should be transmitted by Fax (+49 (0) 7462 2005 93555) or by letter in advance to us, so that this information is available before the equipment/component part arrives. A second copy of this form should accompany the equipment/component part. Eventually the carrier should be informed.

Eine vollständig ausgefüllte Kopie dieses Formblattes soll per Telefax (Nr. +49 (0) 7462 2005 93555) oder Brief vorab an uns gesandt werden, so dass die Information vorliegt, bevor das Gerät/Bauteil eintrifft. Eine weitere Kopie soll dem Gerät/Bauteil beigelegt sein. Ggf. ist auch die Spedition zu informieren.

- Incomplete information or non-conformity with this procedure will inevitably lead to substantial delays in processing. We hope you will have understanding for this measure, which lies outside of our area of influence, and that you will help us to speed up this procedure.

Unvollständige Angaben oder Nichteinhalten dieses Ablaufs führen zwangsläufig zu beträchtlichen Verzögerungen in der Abwicklung. Bitte haben Sie Verständnis für Maßnahmen, die außerhalb unserer Einflussmöglichkeiten liegen und helfen Sie mit, den Ablauf beschleunigen.

- **Please fill out this form completely.**

**Bitte unbedingt vollständig ausfüllen!**

<b>1.</b>	<b>Chamber/ component part / type: / Gerät / Bauteil / Typ:</b>
<b>2.</b>	<b>Serial No./ Serien-Nr.:</b>
<b>3.</b>	<b>Details about utilized substances / biological substances / Einzelheiten über die eingesetzten Substanzen/biologische Materialien:</b>
<b>3.1</b>	<b>Designations / Bezeichnungen:</b>
a)	_____
b)	_____
c)	_____
<b>3.2</b>	<b>Safety measures required for handling these substances / Vorsichtsmaßnahmen beim Umgang mit diesen Stoffen:</b>
a)	_____
b)	_____
c)	_____

<b>3.3</b>	<b>Measures to be taken in case of skin contact or release into the atmosphere / Maßnahmen bei Personenkontakt oder Freisetzung:</b>
a)	_____
b)	_____
c)	_____
d)	_____
<b>3.4</b>	<b>Other important information that must be taken into account / Weitere zu beachtende und wichtige Informationen:</b>
a)	_____
b)	_____
c)	_____
<b>4.</b>	<b>Declaration on the risk of these substances (please checkmark the applicable items) / Erklärung zur Gefährlichkeit der Stoffe (bitte Zutreffendes ankreuzen) :</b>
<input type="checkbox"/>	<b>4.1 For non toxic, non radioactive, biologically harmless materials / für nicht giftige, nicht radioaktive, biologisch ungefährliche Stoffe:</b>
<b>We herewith guarantee that the above-mentioned chamber / component part... / Wir versichern, dass o.g. Gerät/Bauteil...</b>	
<input type="checkbox"/>	Has not been exposed to or contains any toxic or otherwise hazardous substances / weder giftige noch sonstige gefährliche Stoffe enthält oder solche anhaften.
<input type="checkbox"/>	That eventually generated reaction products are non-toxic and also do not represent a hazard / auch evtl. entstandene Reaktionsprodukte weder giftig sind noch sonst eine Gefährdung darstellen.
<input type="checkbox"/>	Eventual residues of hazardous substances have been removed / evtl. Rückstände von Gefahrstoffen entfernt wurden.
<input type="checkbox"/>	<b>4.2 For toxic, radioactive, biologically harmful or hazardous substances, or any other hazardous materials / für giftige, radioaktive, biologisch bedenkliche bzw. gefährliche Stoffe oder anderweitig gefährliche Stoffe.</b>
<b>We herewith guarantee that ... / Wir versichern, dass ...</b>	
<input type="checkbox"/>	The hazardous substances, which have come into contact with the above-mentioned equipment/component part, have been completely listed under item 3.1 and that all information in this regard is complete / die gefährlichen Stoffe, die mit dem o.g. Gerät/Bauteil in Kontakt kamen, in 3.1 aufgelistet sind und alle Angaben vollständig sind.
<input type="checkbox"/>	That the chamber /component part has not been in contact with radioactivity / das Gerät/Bauteil nicht mit Radioaktivität in Berührung kam
<b>5.</b>	<b>Kind of transport / transporter / Transportweg/Spediteur:</b>
Transport by (means and name of transport company, etc.) Versendung durch (Name Spediteur o.ä.)	
_____	
Date of dispatch to BINDER GmbH / Tag der Absendung an BINDER GmbH:	
_____	



**We herewith declare that the following measures have been taken / Wir erklären, dass folgende Maßnahmen getroffen wurden:**

- Hazardous substances were removed from the chamber / component part, so that no hazard exists for corresponding persons in the handling or repair of these items / das Gerät/Bauteil wurde von Gefahrstoffen befreit, so dass bei Handhabung/Reparaturen für die betreffenden Person keinerlei Gefährdung besteht
- The chamber was securely packaged and properly identified / das Gerät wurde sicher verpackt und vollständig gekennzeichnet.
- Information about the hazardousness of the shipment (if required) has been provided to the transporter / der Spediteur wurde (falls vorgeschrieben) über die Gefährlichkeit der Sendung informiert.

We herewith commit ourselves and guarantee that we will indemnify BINDER GmbH for all damages that are a consequence of incomplete or incorrect information provided by us, and that we will exempt BINDER GmbH from eventual damage claims by third parties./ Wir versichern, dass wir gegenüber BINDER für jeden Schaden, der durch unvollständige und unrichtige Angaben entsteht, haften und BINDER gegen eventuell entstehende Schadensansprüche Dritter freistellen.

We are aware that, in accordance with Article 823 of the German Civil Code (BGB), we are directly liable with regard to third parties, in this instance especially the employees of BINDER GmbH, who have been entrusted with the handling / repair of the chamber / component. / Es ist uns bekannt, dass wir gegenüber Dritten – hier insbesondere mit der Handhabung/Reparatur des Geräts/des Bauteils betraute Mitarbeiter der Firma BINDER - gemäß §823 BGB direkt haften

Name: \_\_\_\_\_

Position: \_\_\_\_\_

Date / Datum: \_\_\_\_\_

Signature / Unterschrift: \_\_\_\_\_

Company stamp / Firmenstempel:



Equipment that is returned to the factory for repair must be accompanied by a completely filled out contamination clearance certificate. For service and maintenance works on site, such a contamination clearance certificate must be submitted to the service technician before the start of the works. No repair or maintenance of the equipment is possible, without a properly filled out contamination clearance certificate.

## 16.2 For chambers located in the USA and Canada

### Product Return Authorization Request

Please complete this form and the Customer Decontamination Declaration (next 2 pages) and attach the required pictures. E-mail to: IDL\_SalesOrderProcessing\_USA@binder-world.com

After we have received and reviewed the complete information we will decide on the issue of a RMA number. Please be aware that size specifications, voltage specifications as well as performance specifications are available on the internet at [www.binder-world.us](http://www.binder-world.us) at any time.

Take notice of shipping laws and regulations.

	Please fill:	
Reason for return request	<input type="radio"/> Duplicate order	
	<input type="radio"/> Duplicate shipment	
	<input type="radio"/> Demo	<i>Page one completed by sales</i>
	<input type="radio"/> Power Plug / Voltage	115V / 230 V / 208 V / 240V
	<input type="radio"/> Size does not fit space	
	<input type="radio"/> Transport Damage	Shock watch tripped? ( <i>pictures</i> )
	<input type="radio"/> Other (specify below)	
	_____	
Is there a replacement PO?	<input type="radio"/> Yes <input type="radio"/> No	
<i>If yes -&gt; PO #</i>		
<i>If yes -&gt; Date PO placed</i>		
Purchase order number		
BINDER model number		
BINDER serial number		
Date chamber was received		
Was the chamber unboxed?	<input type="radio"/> Yes <input type="radio"/> No	
Was the chamber plugged in?	<input type="radio"/> Yes <input type="radio"/> No	
Was the chamber in operation?	<input type="radio"/> Yes <input type="radio"/> No	
<i>Pictures of chamber attached?</i>	<input type="radio"/> Yes <input type="radio"/> No	Pictures have to be attached!
<i>Pictures of Packaging attached?</i>	<input type="radio"/> Yes <input type="radio"/> No	

	Customer Contact Information	Distributor Contact Information
Name		
Company		
Address		
Phone		
E-mail		

## Customer (End User) Decontamination Declaration

### Health and Hazard Safety declaration

To protect the health of our employees and the safety at the workplace, we require that this form is completed by the user for all products and parts that are returned to us. (Distributors or Service Organizations cannot sign this form)



NO RMA number will be issued without a completed form. Products or parts returned to our NY warehouse without a RMA number will be refused at the dock.

A second copy of the completed form must be attached to the outside of the shipping box.

<b>1.</b>	<b>Chamber/ component part / type:</b>
<b>2.</b>	<b>Serial No.</b>
<b>3.</b>	<b>List any exposure to hazardous liquids, gasses or substances and radioactive material</b>
<b>3.1</b>	<b>List with MSDS sheets attached where available or needed (if there is not enough space available below, please attach a page):</b>
a)	_____
b)	_____
c)	_____
<b>3.2</b>	<b>Safety measures required for handling the list under 3.1</b>
a)	_____
b)	_____
c)	_____
<b>3.3</b>	<b>Measures to be taken in case of skin contact or release into the atmosphere:</b>
a)	_____
b)	_____
c)	_____
d)	_____
<b>3.4</b>	<b>Other important information that must be considered:</b>
a)	_____
b)	_____
c)	_____

#### 4. Declaration of Decontamination

**For toxic, radioactive, biologically and chemically harmful or hazardous substances, or any other hazardous materials.**

**We hereby guarantee that**

- 4.1 Any hazardous substances, which have come into contact with the above-mentioned equipment / component part, have been completely listed under item 3.1 and that all information in this regard is complete.
- 4.2 That the chamber /component part has not been in contact with radioactivity
- 4.3 Any Hazardous substances were removed from the chamber / component part, so that no hazard exists for a person in the shipping, handling or repair of these returned chamber
- 4.4 The chamber was securely packaged in the original undamaged packaging and properly identified on the outside of the packaging material with the chamber designation, the RMA number and a copy of this declaration.
- 4.5 Shipping laws and regulations have not been violated.

**I hereby commit and guarantee that we will indemnify BINDER Inc. for all damages that are a consequence of incomplete or incorrect information provided by us, and that we will indemnify and hold harmless BINDER Inc. from eventual damage claims by third parties.**

Name: \_\_\_\_\_

Position: \_\_\_\_\_

Company: \_\_\_\_\_

Address: \_\_\_\_\_

Phone #: \_\_\_\_\_

Email: \_\_\_\_\_

Date: \_\_\_\_\_

Signature: \_\_\_\_\_



Equipment returned to the NY warehouse for repair must be accompanied by a completed customer decontamination declaration. For service and maintenance works on site, such a customer decontamination declaration must be submitted to the service technician before the start of work. No repair or maintenance of the equipment is possible without a completed form.

