



Operating instructions

OmniaPure UV | UV/UF | UV-TOC | UV/UF-TOC



Contents

- 1 Safety precautions and user information..... 1
- 2 Intended purpose 4
- 3 Technical data..... 4
- 4 Flow charts 6
 - 4.1 Flow chart for OmniaPure 6
 - 4.2 Flow chart for OmniaPure UV 6
 - 4.3 Flow chart for OmniaPure UV/UF 7
 - 4.4 Flow chart for OmniaPure UV-TOC 7
 - 4.5 Flow chart for OmniaPure UV/UF-TOC..... 8
- 5 Description of the system..... 9
 - 5.1 System construction..... 9
 - 5.2 System equipping 11
 - 5.3 How the system functions..... 11
- 6 Assembly..... 12
 - 6.1 Extent of delivery 12
 - 6.2 Operating environment..... 12
 - 6.3 Assembly..... 13
 - 6.4 Wall mounting..... 15
- 7 Operation concept..... 17
- 8 Putting into operation 19
- 9 Operation 20
 - 9.1 Menu structure..... 20
 - 9.2 Main display 21
 - 9.3 Withdrawal of water / Withdrawal display..... 21
 - 9.4 Menu / Settings 22
 - 9.4.1 System 22
 - 9.4.2 Setup..... 23
- 10 Maintenance and replacements..... 26
 - 10.1 Maintenance and replacement intervals 26
 - 10.2 Cartridge replacement 27
 - 10.3 Disinfection..... 28

11	Faults, Causes and Remedies	29
11.1	Automatic system monitoring.....	29
11.2	Table of faults.....	31
12	Consumables and accessories	33
13	Waste disposal.....	33

1 Safety precautions and user information

The information given here is an important part of the product! Read these instructions completely and thoroughly before you start to install the OmniaPure system and put it into operation for the first time. They provide basic information that is to be observed when setting-up, operating and servicing the system.

These operating instructions must always be available at the operating location. Should your OmniaPure system be passed on to another person, these instructions must be passed on with it.

The personnel must have the necessary qualifications for system operation, maintenance, inspections and assembly work. The operator must clearly set the spheres of responsibility, competencies and supervision of the personnel.

In addition to observance of safety precautions that are given in this section, you must also pay attention to the safety regulations that are valid at the system location, in particular to the accident prevention regulations.

Area of validity

These operating instructions are equally valid for the basic Omnia system version and the UV, UV/UF, UV-TOC and UV/UF-TOC variants that are differently equipped. In the following, "OmniaPure systems" will be used for all five. In the case of differences in the operation of the individual system variants, this will be brought to your attention by appropriate notes.

Symbols used



This warning symbol is given for a danger that, when not avoided, could result in death or serious injury.



This warning symbol is given for a danger that, when not avoided, could result in slight or moderate injury.







This warning symbol warns that there is a risk of moderate property damage.



This symbol refers to particularly useful notes.

Safety precautions

The information given here is for your own safety and assists in avoiding possible damage to the OmniaPure system. Please thoroughly read the entries and follow them exactly.

 <p>WARNING</p>	<p>Danger of an electric shock! An improper supply of electricity to the OmniaPure system can lead to an electric shock!</p> <ul style="list-style-type: none"> - The long-range power pack that is supplied with each OmniaPure system for the electrical supply is exclusively matched to these systems. - For the electricity supply to the long-range power pack of the OmniaPure system, use only a properly earthed socket that supplies an alternating current of 100-240V with 50-60Hz. - For maintenance work, only open the rear housing cover when the electrical connection has been unplugged.
 <p>WARNING</p>	<p>Danger of explosion and burns! Improper operation or disinfection of the OmniaPure system can lead to an explosion or burns!</p> <ul style="list-style-type: none"> - OmniaPure systems are only to be used for water. - Disinfection of OmniaPure systems is to be only carried out by appropriately qualified staff. - For cleaning and disinfection, exclusively use the cleaning agent and disinfectant that have been approved for use with the OmniaPure system. - To carry out disinfection, exactly follow the directions given in these operating instructions and those given in the safety data sheet of the OmniaPure system disinfectant.
 <p>WARNING</p>	<p>Danger from falling! Improper handling or installation of the OmniaPure system can result in a fall of it and could so cause injury!</p> <ul style="list-style-type: none"> - Ensure that the system always has a firm stand. - In the case of wall-mounting, ensure that the system mount is stable. - The holding points of the system that are to be used when handling or transporting it are given in these operating instructions.
 <p>WARNING</p>	<p>Danger of slipping! Wrong or faulty installation or operation, as well as a system leak, can result in an uncontrolled emergence of liquid and so to a danger of slipping!</p> <ul style="list-style-type: none"> - Always pay attention to correct operating of the system and use sufficiently large vessels when withdrawing water. - Check that the supply and lead-off lines have a leak-proof seating. - Ensure that the rinsing water is led pressure-free to drain.



Danger of damage to eyes and skin!

Contact with disinfectant can lead to eye and skin irritation or injury!

- When you carry out disinfection of the OmniaPure system, always wear suitable safety clothing (gloves and protective glasses at the least) to avoid contact with the disinfectant.
- Check the correct and leakproof attachment of connecting hoses to be sure that no disinfectant can leak uncontrolled from the OmniaPure system.
- Exactly follow the directions that are supplied with the disinfectant and disinfection kit.

Emergent UV-radiation can lead to eye and skin irritation or injury!

- Only begin replacement of the UV-lamp in an OmniaPure UV, UV/UF, UV-TOC or UV/UF-TOC system when it has been turned off and the line plug has been unplugged.
- When you have inserted the new UV-lamp, check that it is correctly seated in the UV-reactor.



Danger of squashing and jamming!

Incorrect handling of the OmniaPure system can lead to squashing and jamming injury!

- The holding points that are to be used when handling or transporting the system are given in these operating instructions.
- When handling the movable dispenser arm, pay attention to possible catch-ups in the area of the joint at the main housing. Only move the dispenser arm by holding the dispenser grip.

Further notes

The following notes are to assist you in avoiding damage to the OmniaPure system and the surroundings.



Danger of property damage!

- Exclusively use original accessories and replacement parts for your OmniaPure system. Non-original parts can lead to system damage.
- When constructional changes are made or non-original parts are installed, the conformity declaration (CE) for your OmniaPure system is no longer in effect.
- Protect the system from frost.
- Operate the OmniaPure system exclusively within the given feedwater pressure range.
- Only connect components to the system interfaces that have been approved for use with the OmniaPure system.
- Do not draw off any cables or hoses when the OmniaPure system is running.
- Check that the rinsing outlet hose always allows free run off.

2 Intended purpose

Systems of the OmniaPure series serve to purify water to ultra pure water quality. To guarantee a maximum quality of the ultra pure water with as long a service life of the consumable materials as possible, the OmniaPure System must be fed with water that has been previously pre-treated by a reverse osmosis system, a still or an ion exchanger.

The ultra pure water that is produced finds use as solvent, dilutant or rinsing fluid in greatly differing analytical procedures such as high performance liquid chromatography (HPLC), ion chromatography (IC), atom absorption spectrometry (AAS), ultra trace analysis etc. It is also used in a multitude of chemical and biochemical applications, such as reagent preparation and cell culture media etc.

The water that is produced is not fit for human consumption.

3 Technical data

Demands on the feedwater	
Source	Drinking water pretreated by reverse osmosis, deionisation or distillation
Pressure [bar]	0.5 – 6
Temperature [°C]	2 – 35
Conductivity [$\mu\text{S}/\text{cm}$]	< 2
Turbidity [NTU]	< 1.0
Free chlorine [ppm]	< 0.05
TOC [ppb]	< 50
Bacteria count [CFU/ml]	< 100
Carbon dioxide [ppm]	< 30
Silicate [ppm]	< 2

Product water					
	OmniaPure	OmniaPure UV	OmniaPure UV/UF	OmniaPure UV-TOC	OmniaPure UV/UF-TOC
Conductivity [$\mu\text{S}/\text{cm}$] at 25°C	0.055	0.055	0.055	0.055	0.055
Resistance [$\text{M}\Omega \text{ cm}$] at 25°C	18.2	18.2	18.2	18.2	18.2
TOC [ppb]	5 - 10	1 - 5	1 - 5	1 - 5	1 - 5
Bacteria [CFU/ml]	< 1	< 1	< 1	< 1	< 1
Bacterial endotoxins [EU/ml]	-	-	0.001	-	0.001
Particle > 0.2 μm [1/ml]	< 1	< 1	< 1	< 1	< 1
Max. flow rate [l/min]	up to 2	up to 2	up to 2	up to 2	up to 2

Dimensions and weight	
Height [mm]	725
Depth [mm]	525
Width [mm]	390
Weight of OmniaPure (dry) [kg]	19
Weight of OmniaPure UV (dry) [kg]	20
Weight of OmniaPure UV/UF (dry) [kg]	20
Weight of OmniaPure UV-TOC (dry) [kg]	20
Weight of OmniaPure UV/UF-TOC (dry) [kg]	20

Water connections	
Feedwater inlet	Hose OD 8mm
Rinsing water outlet	Hose OD 8mm
Threaded connector for sterile filter	G1/4"
Sterile filter outlet	Hose nipple 6mm

Electric connections	
Voltage	100 – 240 VAC
Frequency	50/60Hz
Power consumption (max.)	120W
Serial interface	RS 232

Cell constants	
Conductivity feedwater	0.01
Conductivity ultra pure water	0.01
Conductivity TOC	0.01

Materials of component surfaces that contact water	
Inlet solenoid valve	POM, EPDM
Rinsing solenoid valve	POM, EPDM
Withdrawal solenoid valve	POM, EPDM
Pressure reducer	POM
Pump head	Nylon, glass fibre reinforced
Conductivity measuring cell	POM, stainless steel
Hoses	PE
Hose connector	POM
Gaskets	EPDM
UV- Reactor	Stainless steel
UV Immersion tube	Quartz glass
Ultrafilter housing	PC

4 Flow charts

4.1 Flow chart for OmniaPure

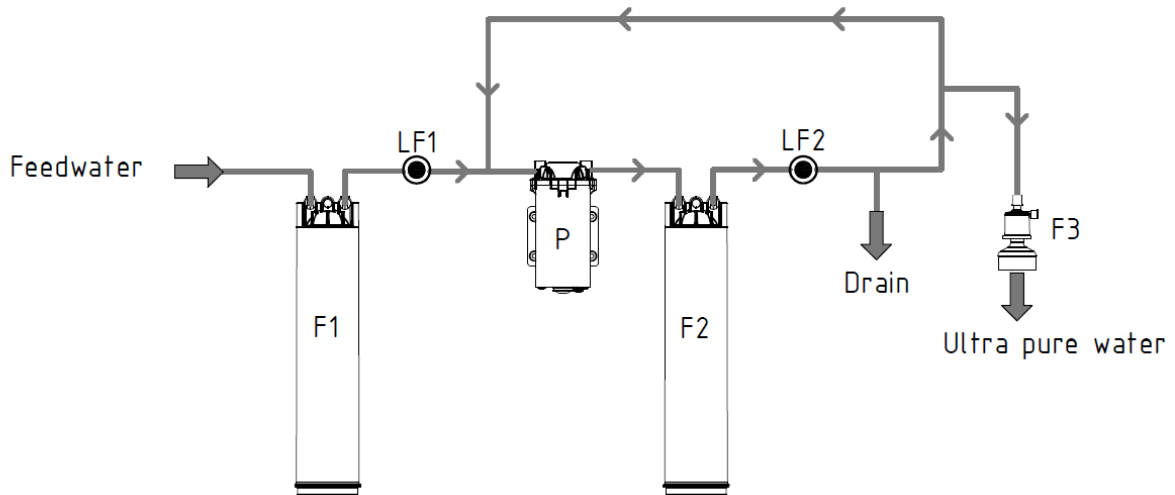

- | | |
|--------------------------------|---|
| F1: Pretreatment cartridge | LF1: Conductivity measuring cell pretreatment |
| F2: Ultra pure water cartridge | LF2: Conductivity measuring cell ultra pure water |
| F3: Sterile filter | P: pump |

4.2 Flow chart for OmniaPure UV

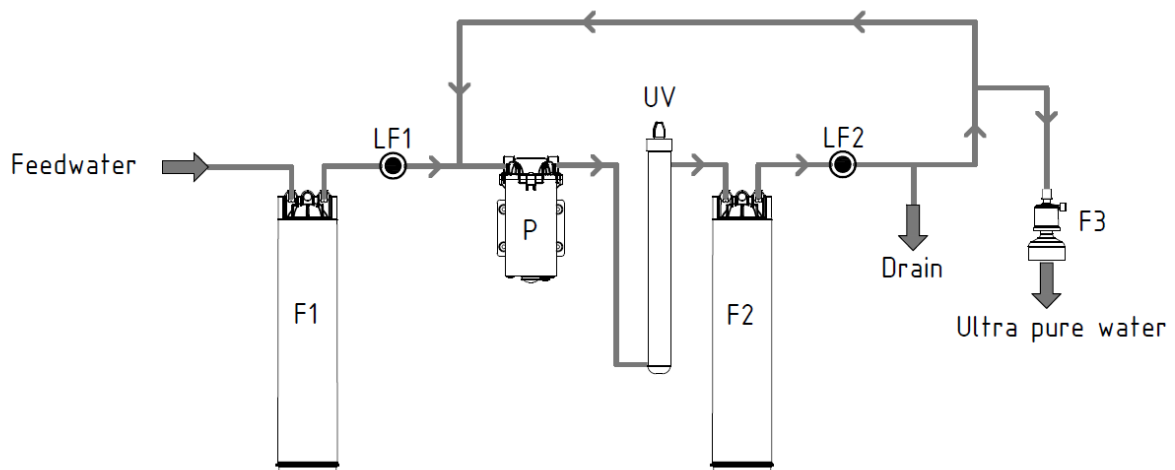

- | | |
|--------------------------------|---|
| F1: Pretreatment cartridge | LF1: Conductivity measuring cell pretreatment |
| F2: Ultra pure water cartridge | LF2: Conductivity measuring cell ultra pure water |
| F3: Sterile filter | P: pump |
| UV: UV disinfection | |

4.3 Flow chart for OmniaPure UV/UF

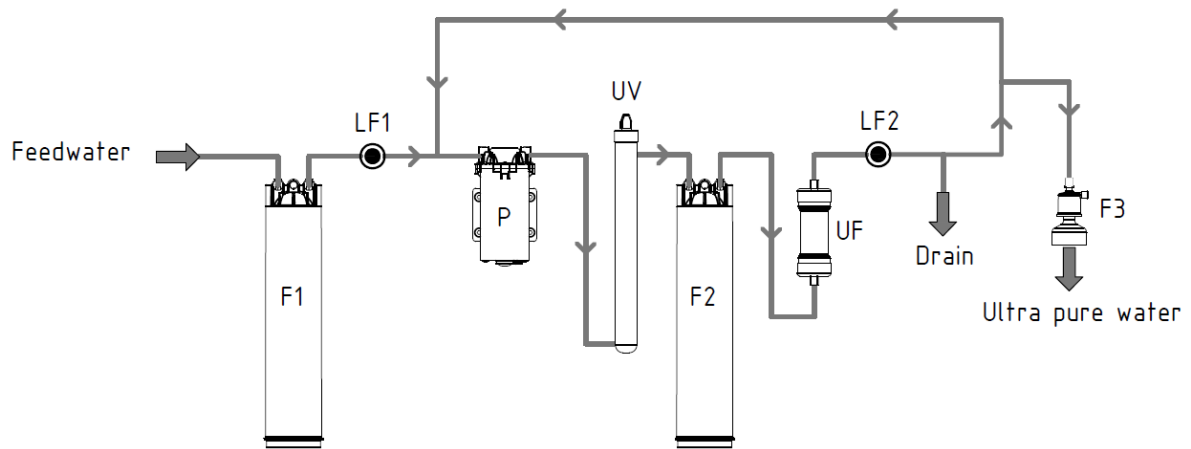

- | | |
|--------------------------------|---|
| F1: Pretreatment cartridge | LF1: Conductivity measuring cell pretreatment |
| F2: Ultra pure water cartridge | LF2: Conductivity measuring cell ultra pure water |
| F3: Sterile filter | P: pump |
| UF: Ultrafiltration module | |
| UV: UV disinfection | |

4.4 Flow chart for OmniaPure UV-TOC

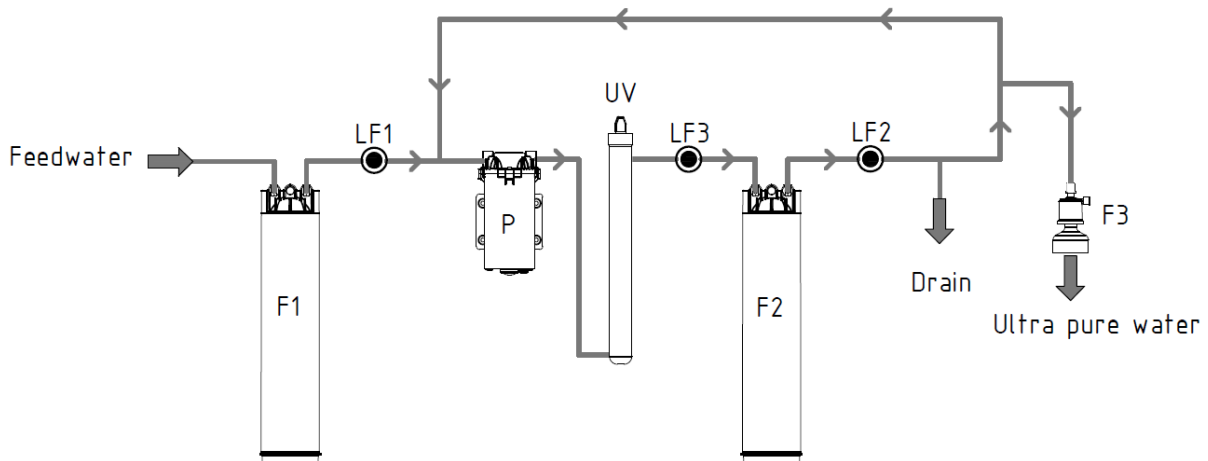

- | | |
|--------------------------------|---|
| F1: Pretreatment cartridge | LF1: Conductivity measuring cell pretreatment |
| F2: Ultra pure water cartridge | LF2: Conductivity measuring cell ultra pure water |
| F3: Sterile filter | LF3: Conductivity measuring cell TOC |
| UV: UV disinfection | P: pump |

4.5 Flow chart for OmniaPure UV/UF-TOC

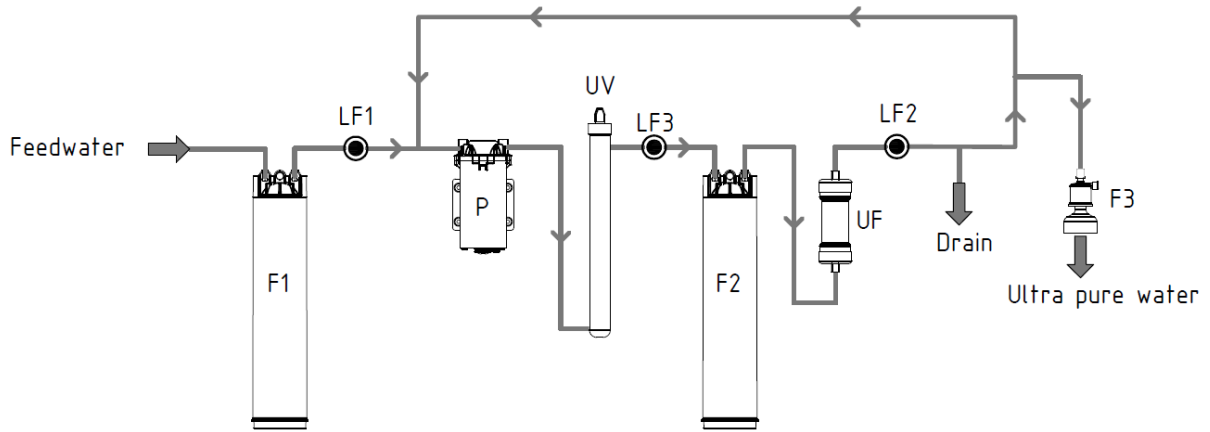

F1: Pretreatment cartridge
 F2: Ultra pure water cartridge
 F3: Sterile filter
 UF: Ultrafiltration module
 UV: UV disinfection

LF1: Conductivity measuring cell pretreatment
 LF2: Conductivity measuring cell ultra pure water
 LF3: Conductivity measuring cell TOC
 P: pump

5 Description of the system

5.1 System construction

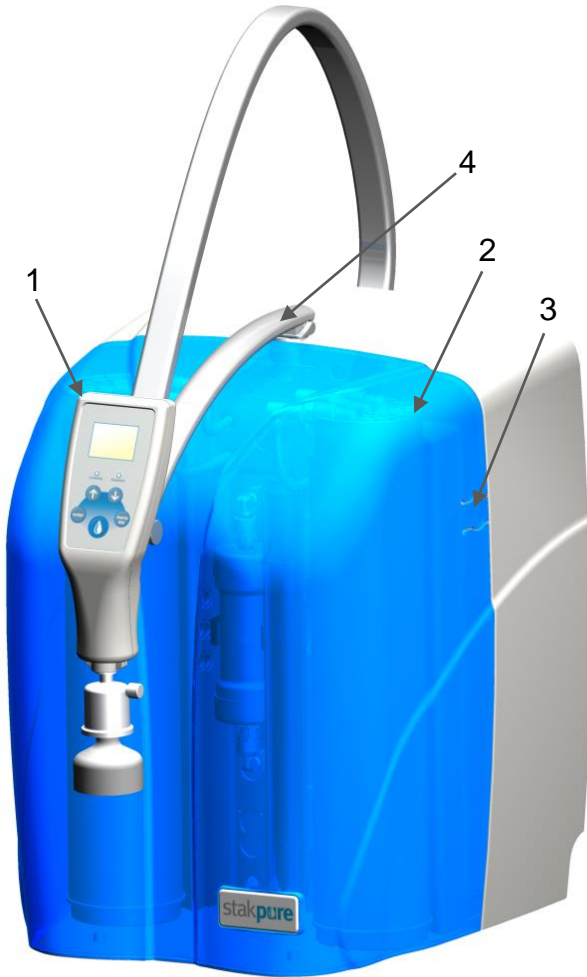

Figure 1: Front view of the OmniaPure system



Figure 2: View without the covering hood

- 1: Removable **OptiFill dispenser** with integrated operating and withdrawal unit
- 2: Removable **covering hood**
- 3: Spring lock
- 4: Turn and height adjustable **dispenser arm**

- 5: Pretreatment cartridge
- 6 Ultra pure water cartridge
- 7: UV-Reactor
- 8: Ultrafiltration module

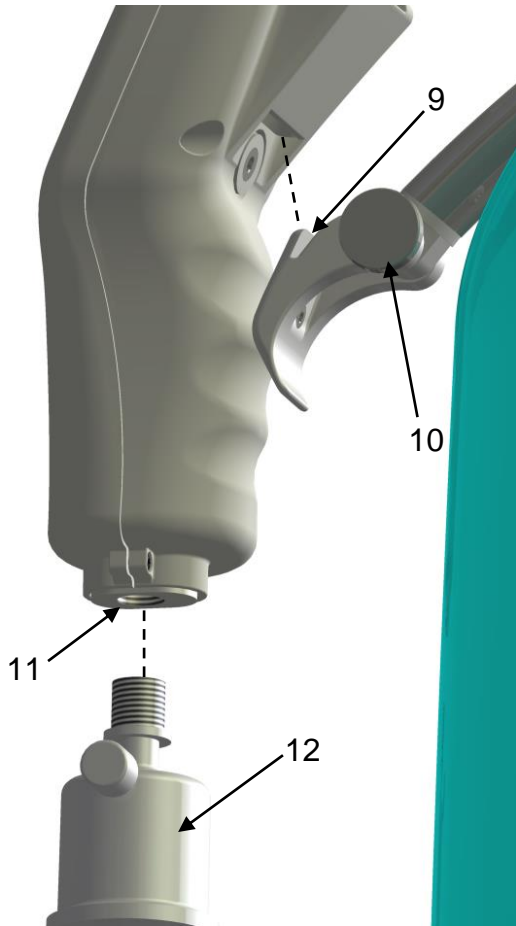

Figure 3: Details of the dispenser intake

- 9: Tiltable dispenser intake
- 10: Dispenser intake adjusting screw
- 11: Outlet with G 1/4" female thread
- 12: Sterile filter with R 1/4" connector

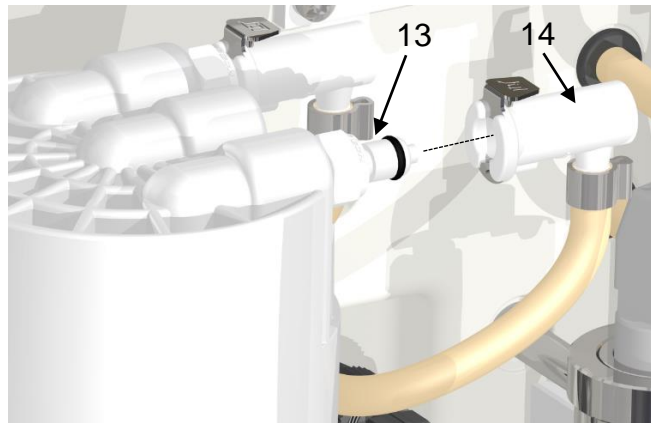

Figure 4: Cartridge connectors

- 13: Quick connect plug
- 14: Quick connect coupling

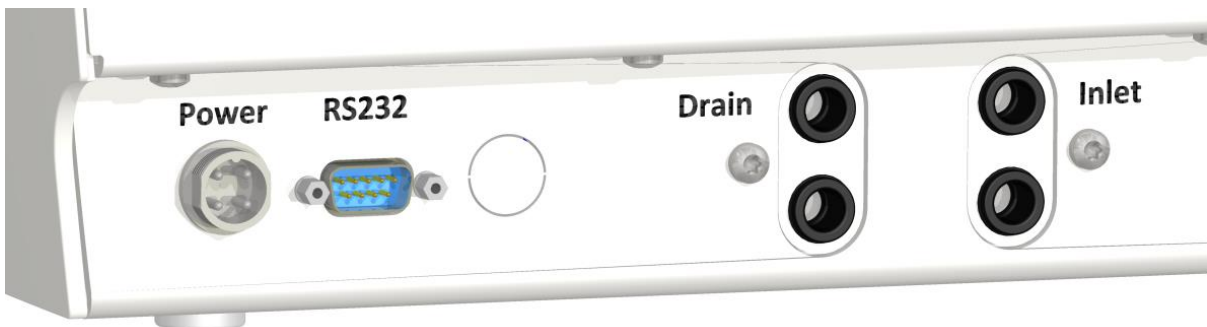

Figure 5: System connections

- Inlet: Feedwater connection
- Drain: Rinse water connection
- Power: Voltage supply connector
- RS232: Connector for an optional printer

5.2 System equipping

The difference between the individual system variants in the OmniaPure series is their equipping. The following table shows the five different variants and how they differ.

System	Article no.	Pretreatment cartridge	Ultra pure water cartridge	UV-Disinfection	Ultra-filtration	TOC-Monitor
OmniaPure	18200001	●	●	-	-	-
OmniaPure UV	18200002	●	●	●	-	-
OmniaPure UV/UF	18200003	●	●	●	●	-
OmniaPure UV-TOC	18200004	●	●	●	-	●
OmniaPure UV/UF-TOC	18200005	●	●	●	●	●

5.3 How the system functions

The systems of the OmniaPure series utilize several purification technologies to convert previously treated water to ultra pure water that fulfils the current requirements of the ASTM, ISO, USP and CLSI Norms.

The water that is fed to the OmniaPure system as feedwater must have been previously subjected to reverse osmosis, distillation or deionisation. As can be seen in "4 Flow charts", the feedwater first flows through the pretreatment cartridge to remove most ions and organic compounds. The quality of the water that has been so treated (and so also the condition of the pretreatment cartridge) is continually monitored by the first conductivity meter (LF1). The actual values of the conductivity measurement can be shown for controlling purposes in the display of the operating/withdrawal unit (OptiFill dispenser).

The next step is only for OmniaPure UV, UV/UF, UV-TOC and UV/UF-TOC. The water is pumped into the UV-reactor, where it is disinfected by UV radiation.

The treated water of all three versions flows through an ultra pure water cartridge for removal of remaining ions.

OmniaPure UV/UF and UV/UF-TOC version is further subjected to filtration by an ultrafiltration module for maximum removal of non-ionised compounds.

Prior to water withdrawn from the OptiFill dispenser, the quality of it and the condition of the consumable materials is monitored by a temperature compensated conductivity measurement (LF2). The measured values of the conductivity and temperature are shown in the OptiFill dispenser display.

As final purification step, the ultra pure water passes through a sterile filter directly prior to withdrawal.

When no water is being withdrawn and to ensure a high ultra pure water quality, all OmniaPure systems periodically circulate the ultra pure water through the ion exchange cartridge, UV-reactor and ultrafiltration module, according to the respective system.

6 Assembly

When you receive the OmniaPure system you ordered, first check the packaging for possible signs of damage during transport before you remove the system from the packaging and check the outside of it for signs of damage.

Your OmniaPure system has been tested and carefully packed, despite this, damage during transport can unfortunately not be completely ruled out. If your OmniaPure system has been damaged during transport, contact the appropriate destination carrier or shipping agent immediately. In this case, keep the complete packaging as possibly needed proof of the complaint or for return shipment.

6.1 Extent of delivery

The extent of delivery of your OmniaPure system is as follows:

Position	Amount	Designation
01	1	OmniaPure system
02	1	Table-top power pack 48V 120W
03	1	Power cord
04	1	PE Hose d8 2.5m
05	1	PE Hose d8 including protective inlet filter and R ¾" – d8 water connector adapter
06	2	Angle attachment d8
07	1	Pretreatment cartridge
08	1	Ultra pure water cartridge
09	1	Sterile filter
10	1	Operating instructions

6.2 Operating environment

When selecting the installation location, take heed of the following requirements:

- The ambient temperature must be at least +2°C.
- The feedwater pressure must be between 0.5 and 6 bar.
- The surface that the system is to stand on must be level.
- A suitable earthed-contact socket outlet must be available for the electric supply to the OmniaPure system (refer to "3 Technical data")
- The OmniaPure system must be easily accessible for maintenance work.
- There must be sufficient room around the system for convenient operating of it.
- An in-house feedwater connector with R¾" male thread that can be shut-off is required.
- A free flowing drain is required for the rinsing water

The system is exclusively intended for use in an industrial environment. Electromagnetic immunity to interference cannot be guaranteed in other environments.



- Temperatures below +2°C could lead to frost damage to the system!
- The feedwater pressure must be less than 6bar, otherwise the system could suffer damage! When necessary, install a pressure reducer.
- Ensure that a free flowing drain is available to avoid water damage!

6.3 Assembly



Danger of an electric shock!

An improper supply of electricity to the OmniaPure system can lead to an electric shock!



- Exclusively use the long-range power pack that is supplied with the OmniaPure system for the electricity supply.
- For the electricity supply to the long-range power pack of the OmniaPure system, exclusively use a properly earthed socket which makes an alternating current of 100-240V with 50-60Hz available.
- To lift the system, exclusively grip the bottom, back or sides of the main housing.

Stand the OmniaPure system at the installation location and ensure that it is securely standing. To transport the system, lift it exclusively by gripping the bottom, back or sides of the main housing (refer to page 14 Figure 6: Holding points). When the OmniaPure system is to be wall-mounted, please use the wall bracket that is obtainable as option and follow the assembly instructions that are included with it, as well as the description under “6.4 Wall mounting”.



Make sure that the system has acclimatised to room temperature before starting to put it into operation.

Remove the covering hood of the OmniaPure system (refer to page 8 Figure 2: View without covering hood). Fit the pretreatment cartridge in the standing position on the right and the ultra pure water cartridge in that on the left. Use the quick connect couplings to connect the cartridges to the system (refer to page 9 Figure 4: Cartridge connectors) and fit the covering hood back on.



Utilize the half-round bulge of the main housing for easier positioning of the cartridges.

Hang the OptiFill dispenser in the intake at the dispenser arm and position it vertically (refer to page 9 Figure 3: Details of the dispenser intake).



You can use the knurled screw at the intake to adjust the resistance of the inclination adjustment.

Use the connecting accessories to connect the OmniaPure system to the feedwater connector and to the free run-off. Consider the feedwater requirements here (refer to 3 Technical data). First connect the R $\frac{3}{4}$ " female thread of the water connection adapter (with hose connector) to the connector of the in-house feedwater supply. Now fit the free end of the 8mm hose in the 8mm quick connect that is labelled "Inlet" and is at the back of the system (refer to page 9 Figure 5: System connections). Connect the second 8mm hose to the system connector labelled "Drain" and lead the free end of it to a drain to which the rinsing water can freely flow out.

Screw the sterile filter with R $\frac{3}{4}$ " thread in the outlet of the OptiFill dispenser (refer to page 9 Figure 5: Details of the dispenser intake).

Plug the four-pole coupling of the power pack in the "power" connector of the OmniaPure system. Secure the connection with the union screw of the coupling. Ensure that the power cord is connected to the table power pack, then plug the earthed-contact plug in a suitable earthed-contact socket outlet (refer to 3 Technical data).

Finally open the closed water tap at the in-house feedwater connector.

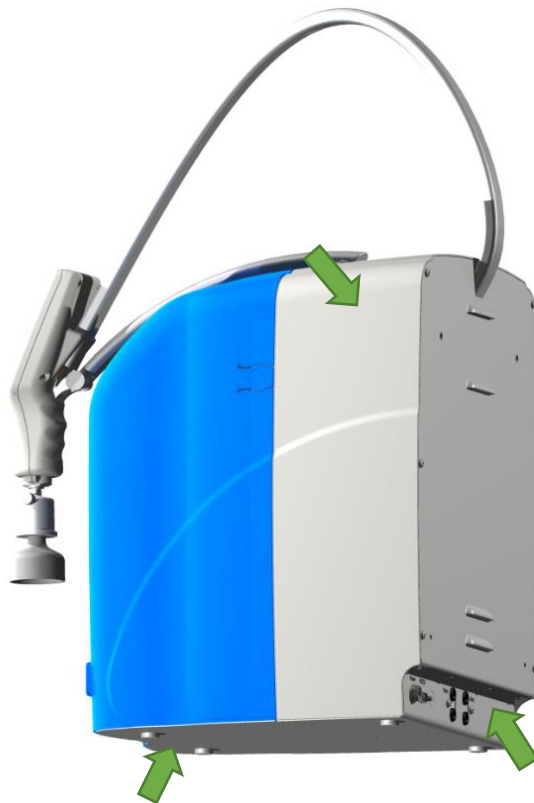

Figure 6: Holding points

6.4 Wall mounting



Danger of squashing injury when dropped!

The OmniaPure system is to be exclusively fixed to a suitable wall with the OmniaPure system wall mount that is optionally available. Check that the wall and the mounting material have a sufficient weight-bearing capacity of at least 100kg. The mounting material that is supplied with the wall mount is designed for use in concrete or solid brick walls. Test the suitability of it for your wall material. If necessary, exchange it for suitable one.

The optional wall mount enables you to save work space by fixing your OmniaPure system to a suitable wall. It requires a free wall surface of about 60cm width and 80cm height. We recommend, for professional and reliable mounting, that our customer service carries it out,

Your OmniaPure system must first be appropriately prepared for wall mounting (the parts that are required for wall mounting are included in the extent of delivery of the wall mount). Do this by first screwing the two M8 threaded studs in the two upper screw-threaded inserts that are on the back of the system (Figure 8: Wall mount rail). Now screw the two bump stoppers in the M8 screw-thread inserts that are on the back of the system (Figure 8: Wall mount rail).

The next step is to have the wall mount rail fixed to the wall. This requires 6 boreholes of 8mm diameter and at least 60mm length. Make the boreholes in the positions shown in Figure 7: Wall mount rail. When doing this, make sure that the upper and the lower lines of three boreholes are each exactly horizontal.

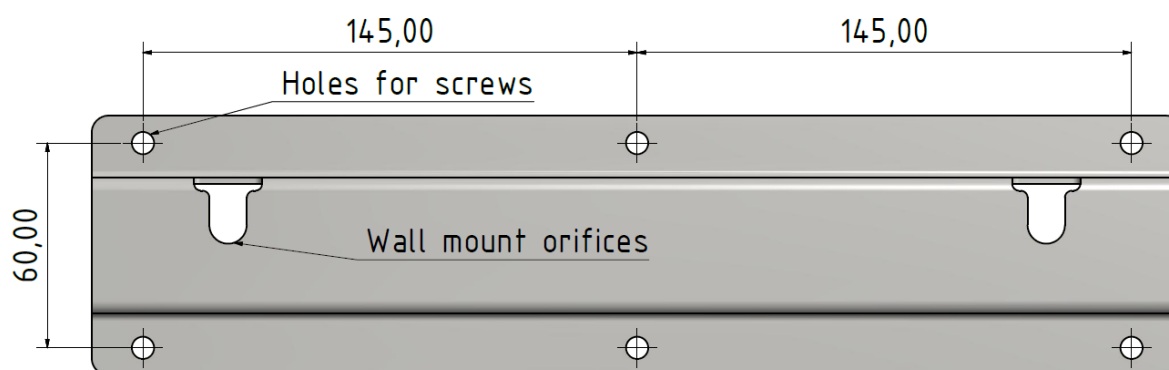

Figure 7: Wall mount rail

Following this, fit a wall plug in each of the boreholes and screw the wall mount rail so on the wall that the rounded sides of the two orifices are pointing downwards. Pay attention here to the fact that the fixing materials supplied with the wall mount are for mounting in concrete or solid brick. Should it be necessary to fix the wall mount to a wall of a different material, then a different, suitable, fixing material must be used.

The OmniaPure system can now be hung in the wall mount rail. To do this, lift the system by gripping it at the holding points (refer to page 14 Figure 6: Holding points). Protect yourself against dropping the system by being helped by a second person. Hang the two studs of the system in the wall mount orifices (refer to page 16 Figure 8: Wall mounting). Ensure that the system is additionally supported by the two bump stops.

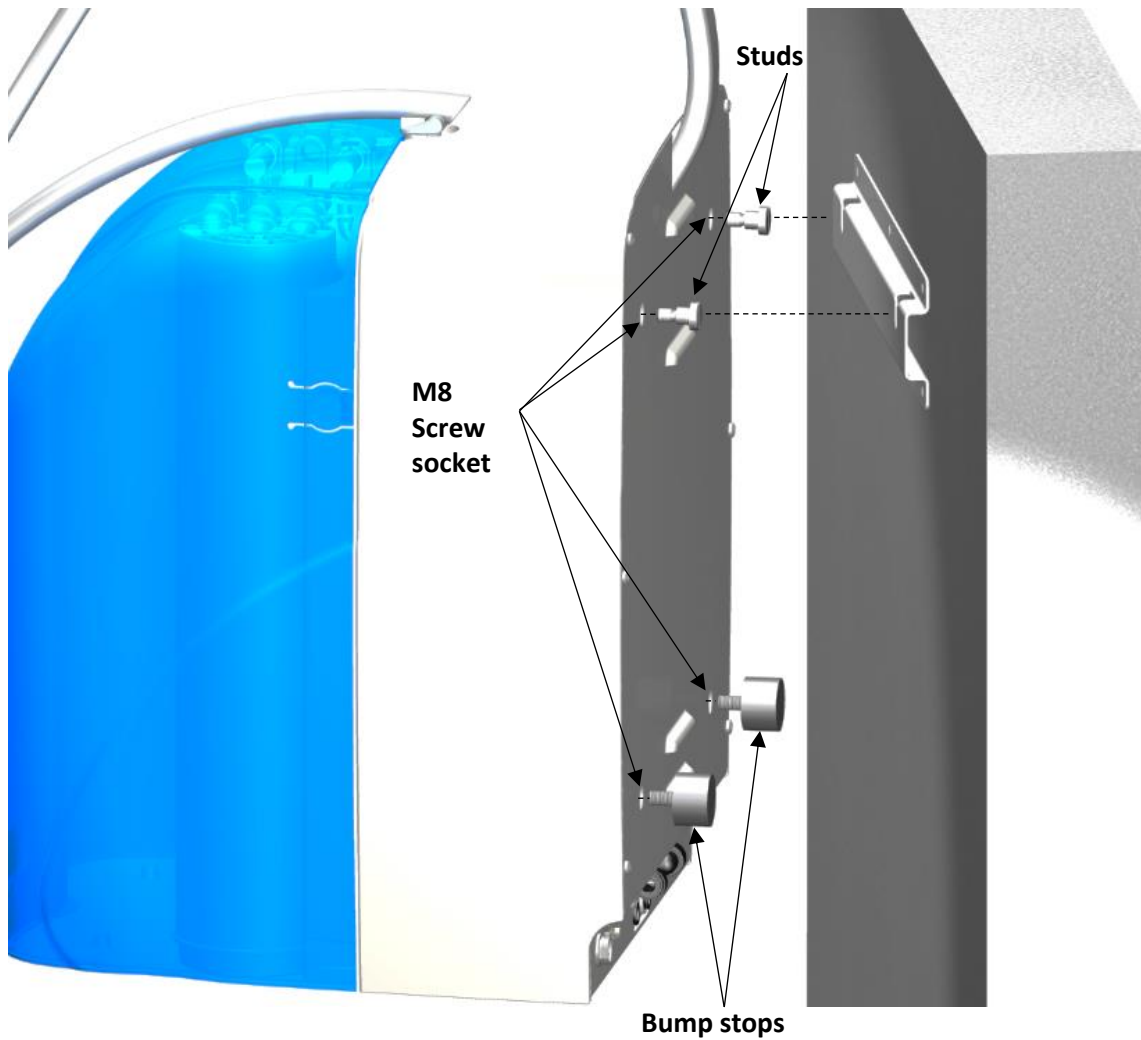

Figure 8: Wall mounting

7 Operation concept

Operation of the OmniaPure system is carried out with five buttons and the OptiFill dispenser display. The following illustration shows the positions and designations of the individual buttons.

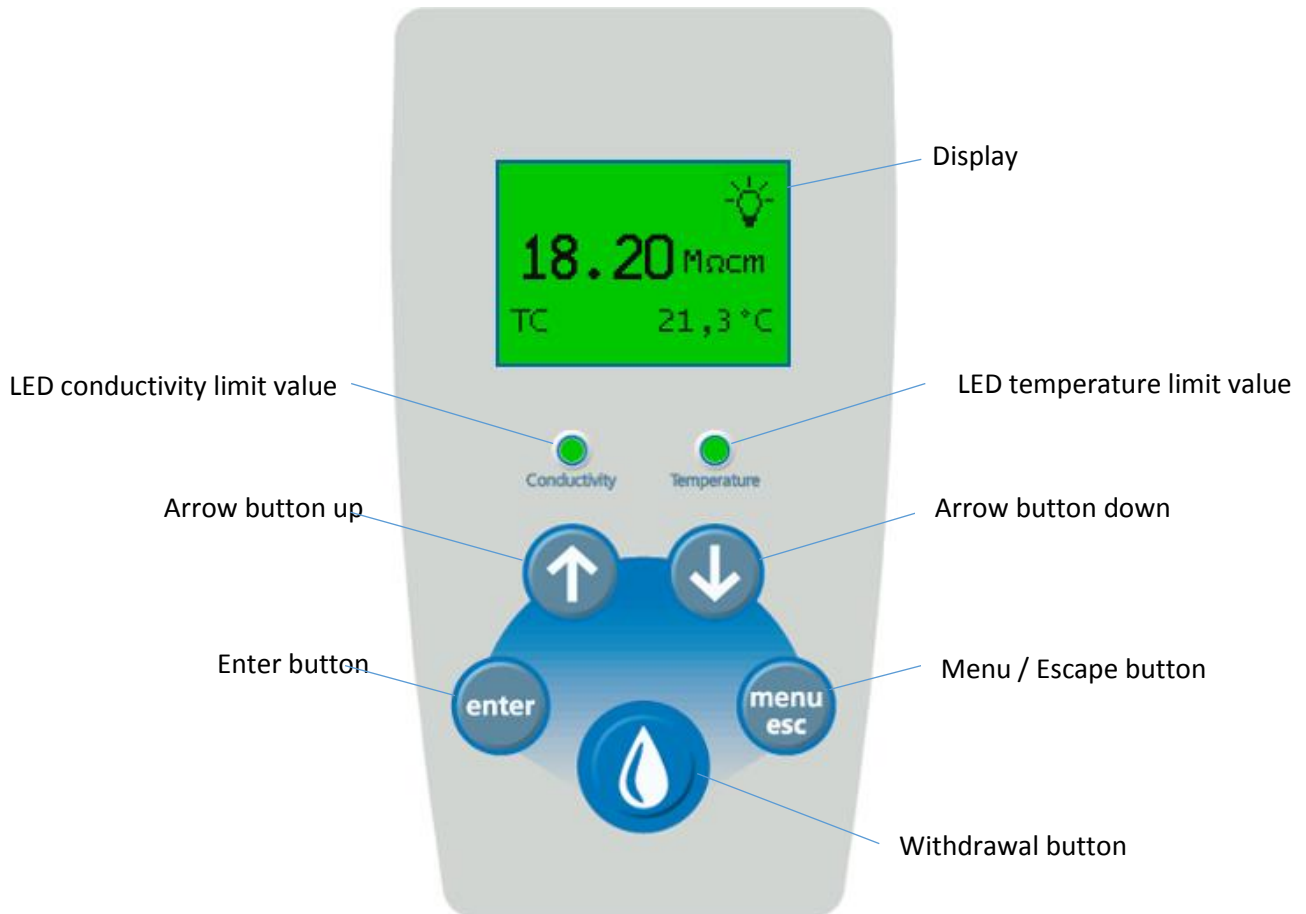

Figure 9: Operating unit

Display

The display can show all settings, system conditions and measured values. The main display is shown above in the “Figure 9: Operating unit”. It automatically appears at the start of the system. In normal operation it is lit up green. When a system fault occurs or a limit value is exceeded, the green colour changes to red.

LED conductivity limit value

If the conductivity limit value is set to Off (refer to 9.4.2 Setup) or the actual measured value of the conductivity is below the set limit value, the LED lights up green. If the limit value is exceeded, the LED lights up red.

LED Temperature limit value

This LED lights up green when the temperature limit value is set to “Off” (refer to 9.4.2 Setup) or when the actual measured value of the temperature is below the set limit value. It lights up red when the limit value is exceeded.

Withdrawal button

When the system shows the main display, a press on the withdrawal button opens the withdrawal display (see 9.3 Withdrawal of water / Withdrawal display). With all other displays, the withdrawal button only has a function when the symbol for the withdrawal button symbol  is given alongside the particular command.

Menu-/ Esc-button

A press on the Menu-/Esc-button in the main display brings you to the selection menu (see 9.4 Menu / Settings). In all other displays, this button takes on the ESC function with which you can abort an input at any time or return to the previous menu level.

Enter button

When you have opened a display in which you wish to make an entry, a press on the Enter button activates the input function. The activation of the input function is acknowledged by a blinking cursor signals input function activation. When this function is active, a further press on the Enter button confirms the input/selection and switches to the next input field or ends the input function.

Arrow button up

This arrow button enables you to scroll a particular menu upwards. When an input function is active, you can increase a given value in this or change the selection at the actual cursor position.

Arrow button down

This arrow button enables you to scroll a particular menu downwards. When an input function is active, you can decrease a given value in this or change the selection at the actual cursor position.

8 Putting into operation

The system starts as soon as it is supplied with voltage.

When the system starts, the start screen shown on the right is displayed. The system designation is shown above the serial number and the Firmware version of your system.

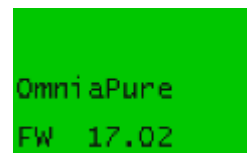

The system is already factory-set, so you only need to put new cartridges in position and then carry out a rinse as described in the following:

As soon as the start screen goes out, it is replaced by the main screen. Now you can open the menu selection by pressing the Menu/Esc button.

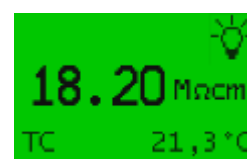

Now use the arrow button to choose between "Setup" and "System". Select "Setup" with the Enter button to open the set-up menu.

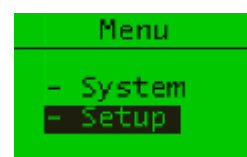

Use the Enter button to activate entry of the PIN. Now use the arrow buttons to enter the first position of the Pin. A renewed push on the Enter button changes to the second position. Carry on with this until you have completely entered four figures in the Pin. The Pin is preset with 0000.

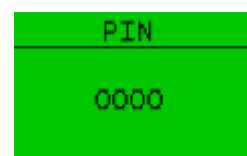

In the setup menu you can first set the setting for the conductivity limit value of measuring cell LF1. Browse with the down arrow-key to the "Flush" entry.

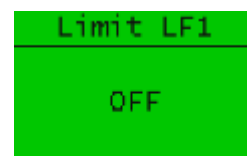

Activation of the withdrawal button starts the rinsing process. Let the system be rinsed for about 3 minutes. End rinsing with a further press on the withdrawal button. Use the Menu/Esc button to return to the main display.

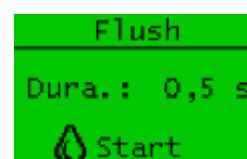

Withdraw about 1 litre of water and discard it. Now press the withdrawal button to open the withdrawal display. Start withdrawal with a further press on the withdrawal button. The withdrawal is automatically stopped when the pre-set 1 litre has been withdrawn. Return to the main display by pressing the Menu-/Esc button.

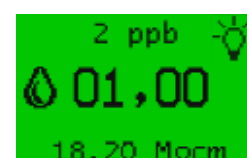

The system has now been rinsed and is ready to use. It is automatically in recirculation operation. The conductivity could be somewhat higher to start with, but this improves during recirculation.

9 Operation

The menu structure, the displays and the setting possibilities of the OmniaPure system are described in the following. Navigate in the menu and change settings as described under “7 Operation concept”.

9.1 Menu structure

The following diagram pictures the menu structure of the OmniaPure system. Operating the Menu-/Esc-button brings you from the main display to the menu selection. From here you can reach Setup and the system menu. You can scroll through menus with the arrow buttons. When you operate the withdrawal button you change from the main display to the withdrawal display.

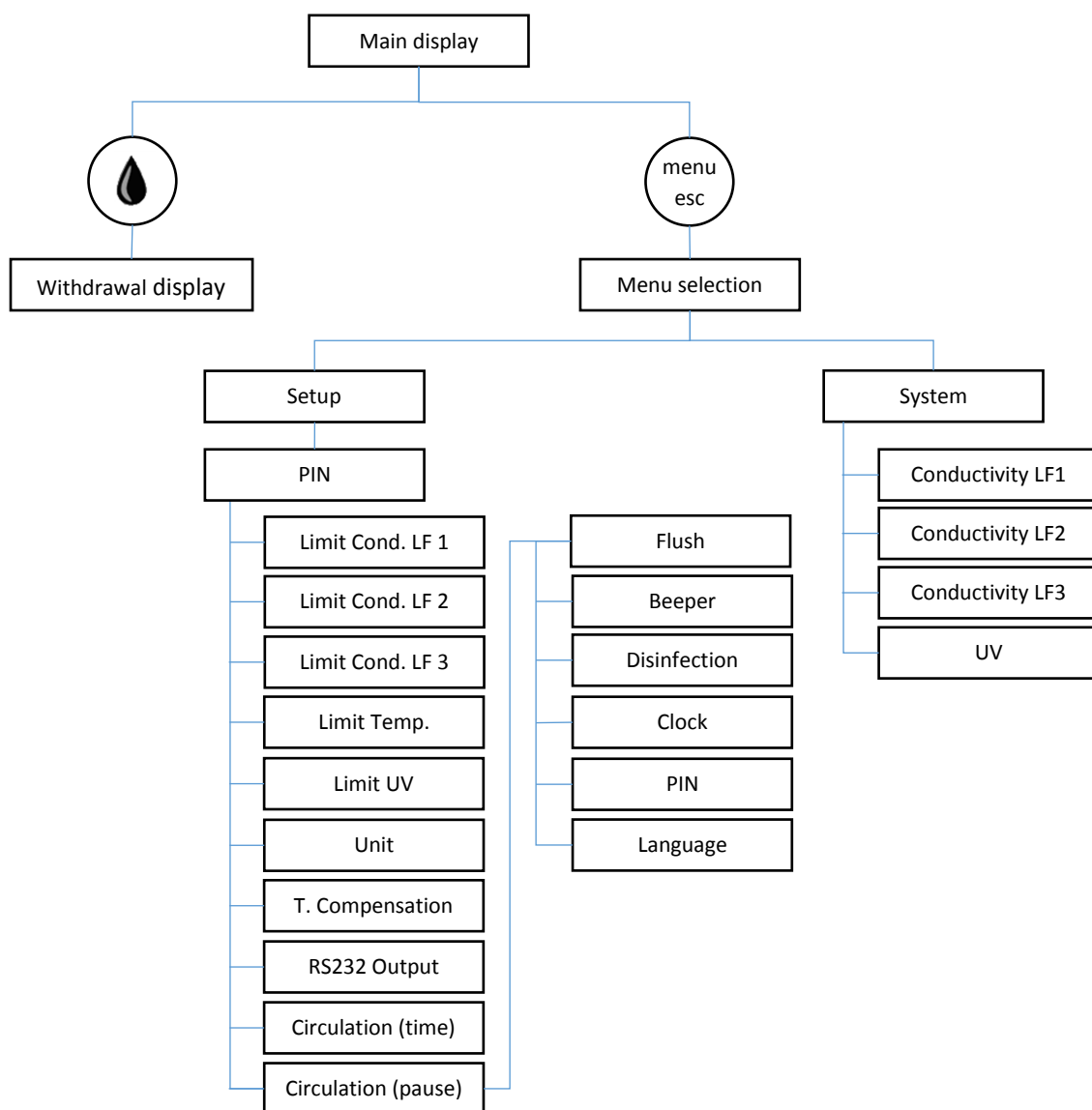

Figure 10: Menu structure

9.2 Main display

The main display (refer to page 21 Figure 11: Main display) is automatically shown when the system is switched on. It provides information on the actual system condition and shows you the measured value of the conductivity at the withdrawal point (LF2) in the unit that has been set ($\mu\text{S}/\text{cm}$ or $\text{M}\Omega\text{cm}$) as well as the temperature of the ultra pure water. Further to this, it shows if the conductivity measurement is made with temperature compensation (TC) or without it (NTC). If your version is an OmniaPure UV, UV/UF, UV-TOC or UV/UF-TOC the lamp symbol provides information on the operating condition of the UV-lamp when it is switched on.

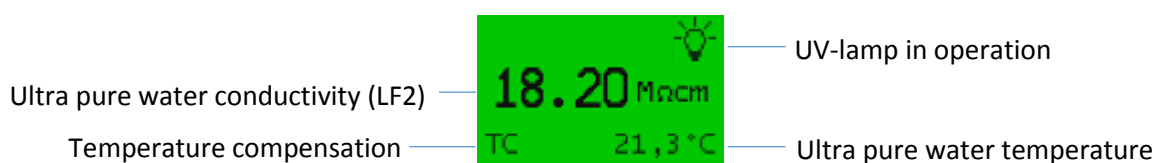

Figure 11: Main display

9.3 Withdrawal of water / Withdrawal display

Operating of the withdrawal display brings you from the main display to the withdrawal display. In the case that the system does not start the circulation, rinsing is being carried out. This only takes about 3 seconds and ensures high ultrapure water quality. When the system was first in circulation, it is directly ready for withdrawal. In the withdrawal display, you can select a volume from the preset withdrawal volumes. To do this, use the arrow buttons to select the one you want and start withdrawal with a press on the withdrawal button. The withdrawal stops automatically when it reaches the set withdrawal volume, alternately you can end the withdrawal at any time by a further press on the withdrawal button. You can see the actual volume of ultra pure water that has been taken during withdrawal in the display. The ultra pure water conductivity and the TOC value (only OmniaPure UV-TOC and UV/UF-TOC) is shown and acts as a check on the ultra pure water quality. When withdrawal has finished, the system continues in the regular mode (circulation or interval) according to the parameters set (see 9.4.2 Setup). If no input is given within a minute, the system automatically returns to the main display.

Withdrawal volume / l	0.05	0.10	0.15	0.20	0.25	0.30	0.40	0.50	0.60	0.80
Withdrawal volume / l	1.00	2.00	3.00	5.00	10.00	20.00	25.00	30.00	60.00	

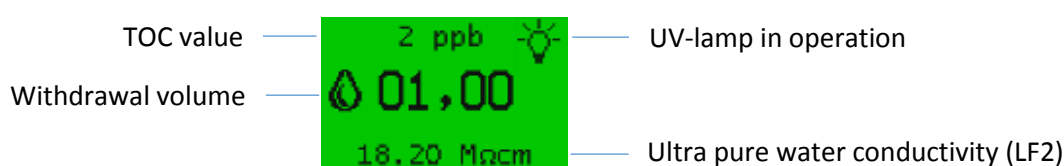
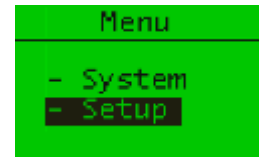

Figure 12: Withdrawal display

9.4 Menu / Settings

When the main display is open, press the Menu/Esc button to go to menu selection. Use the arrow buttons to choose here between “System” and “Setup”.



9.4.1 System

If you have selected “System”, you can use the arrow buttons to go to the following menu items:

“LF1” shows the actual measured value of measuring cell LF1. It displays the conductivity in the selected unit as well as the temperature of the water subsequent to the pretreatment step.

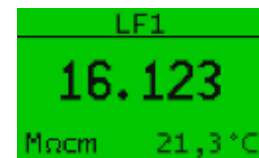

“LF2” shows the actual measured value of measuring cell LF2. It displays the conductivity in the selected unit as well as the temperature of the water subsequent to the ultra pure water cartridge.

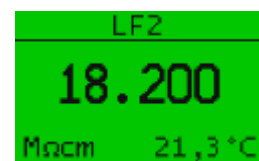

“LF3” shows the actual measured value of measuring cell LF3. It displays the conductivity in the selected unit and the temperature of the water subsequent to the UV-lamp.

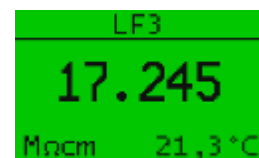

With systems that have flow-through disinfection, the “UV” menu entry shows the operating time of the UV-lamp. With systems that incorporate a UV intensity measurement, the service life of the UV-lamp is shown as a relative value in percent.

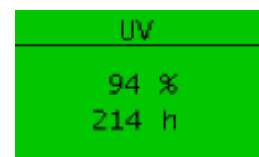

9.4.2 Setup

When “Setup” is required, you must first make a Pin entry. When you have entered the correct Pin with the help of Enter and the arrow keys (see 7 Operation concept), the following menu items are at your disposal:

Under the “Limit LF1” menu entry, you can set the limit value for the conductivity LF1 that is measured downstream of the pretreatment cartridge. When this limit value is gone above ($\mu\text{S}/\text{cm}$) or gone below ($\text{M}\Omega\text{cm}$), a corresponding warning message is given. The following setting ranges are at your availability:

0.100 – 50.0 $\mu\text{S}/\text{cm}$ or 10.0 – 0.02 $\text{M}\Omega\text{cm}$ and OFF

The limiting value is automatically deactivated when you enter a value of 00.000 (OFF).

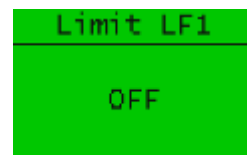

Under the “Limit LF2” menu entry, you can set the limit value for the conductivity LF2 that is measured downstream of the ultra pure water cartridge. When this limit value is gone above ($\mu\text{S}/\text{cm}$) or gone below ($\text{M}\Omega\text{cm}$), a corresponding warning message is given. The following setting ranges are at your availability:

0.056 – 50.0 $\mu\text{S}/\text{cm}$ or 18.1 – 0.02 $\text{M}\Omega\text{cm}$ and OFF

The limiting value is automatically deactivated when you enter a value of 00.000 (OFF).

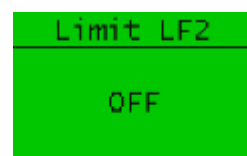

Under the “Limit LF3” (only menu entry, you can set the limit value for the conductivity LF3 that is measured downstream of the UV-lamp. When this limit value is gone above ($\mu\text{S}/\text{cm}$) or gone below ($\text{M}\Omega\text{cm}$), a corresponding warning message is given. The following setting ranges are at your availability:

0.056 – 50.0 $\mu\text{S}/\text{cm}$ or 18.1 – 0.02 $\text{M}\Omega\text{cm}$ and OFF

The limit value is automatically deactivated when you enter a value of 00.000.

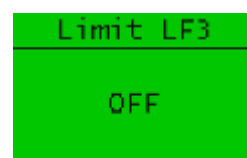

Under the menu item “Limit Temp.”, you have the possibility to set a limit value for the temperature measurement of the ultra pure water in a setting range of from 1.0 – 50.0°C. To deactivate the limit value, enter a value of 00.000.

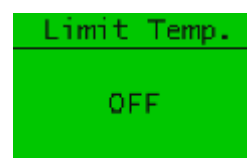

If your system is equipped with an optional UV intensity measurement, you can enter a percentage limit value for the intensity measurement of the UV-lamp under “Limit UV”. Should this limit value be gone below, the system emits a corresponding message via the display. The setting range is 1% – 98%. To deactivate the limit value, enter a value of 00.000.

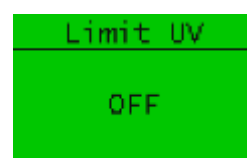

The “Unit” menu entry enables you to choose between conductivity values in $\mu\text{S}/\text{cm}$ or in $\text{M}\Omega\text{cm}$.

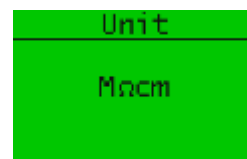

“T. Compensation” enables you to choose between measurement of the conductivity with (ON) or without (OFF) temperature compensation. When temperature compensation is switched on, “TC” is shown in the main display. When it is switched off, “NTC” is displayed.



You can individually set the data output interval via the RS232 interface at the “RS232 Output” menu item.

The setting range is 1 – 1500 minutes.

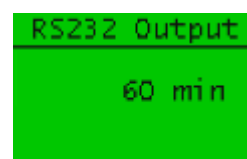

You can set the length of time of the circulation in minutes at the “Circulation” (Duration) menu item. The following settings are at your availability:

0 – 99 minutes, the setting 0 min deactivates circulation

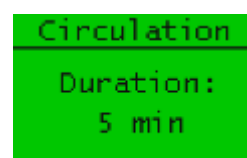

You can set the duration of the pause between the individual circulation phases at the menu item “Circulation” (Pause). You can set this interval time in the following ranges:

0 – 60 minutes, the setting 0 min causes permanent circulation

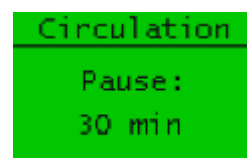

On switching on, and at both the start and end of a circulation phase, the system automatically carries out a rinse for the rinse time shown here. The setting range for the length of time of automatic rinse is 0.1 – 10s.

You can manually activate a rinse by a press on the withdrawal button. The system then keeps rinsing until it is stopped by a further press on the withdrawal button.

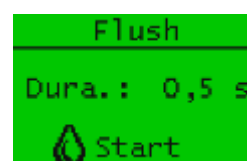

If a fault occurs (see 11.1 Automatic system monitoring), an acoustic signal is emitted. You can turn this function on or off via the menu item “Beeper”.



The “OFF” setting has no effect on the issue of a warning signal when a “Leak” message is given.

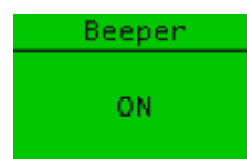

When required, a disinfection of the system can be carried out via the menu item "Disinfection". Please note that only appropriate qualified personnel are to carry out disinfection.

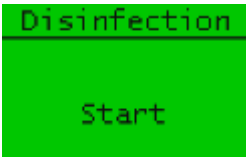

You can optionally set the system time and date under the menu item „Clock“. Proceed as given under „7 Operation concept“ to change the setting.

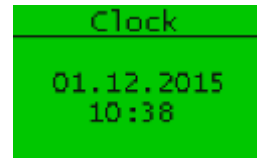

The "PIN" menu item gives you the possibility to change the setup access PIN. The default value is set to 0000. To change the pin, you must first enter the actual pin.

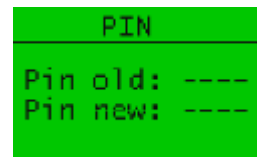

You can choose between English and German as display language.

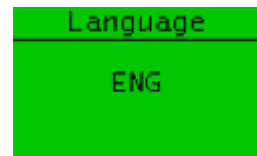

10 Maintenance and replacements

Regular maintenance and replacements are required to ensure that the OmniaPure system provides a constantly high water quality. We recommend that you close a contract for professional and regular maintenance of your OmniaPure system with an authorised service company.



The warranty for the system loses its validity when improper maintenance, service or repair work is carried out on the system, replacement parts and consumable materials that have not been approved are used and/or if conversion measures are carried out. The Declaration of Conformity also becomes invalid.

10.1 Maintenance and replacement intervals

The frequency of replacement measures mostly depends on the quality of the feedwater and the water volumes that are withdrawn. The following table lists safekeeping intervals. These are recommendations and the measures could be more quickly needed according to the demands made on the ultra pure water.

Replacement	Article no.	Interval
Replace the pretreatment cartridge	19200002	12 months
Replace the ultra pure water cartridge	19200003	12 months
Change the UV lamp	19200055	24 months
Change the ultrafiltration module	19000050	24 months
Disinfection		12 months
Disinfection kit	19200056	
Disinfectant	19200057	

10.2 Cartridge replacement

Cartridges are to be replaced at regular intervals (12 months) or earlier when the limit values that you have entered are permanently exceeded. The time that the particular filter cartridge was first connected is taken to be the start of the interval. Proceed as follows to replace pretreatment and ultra pure water cartridges:

1. Switch the OmniaPure System off by separating it from the line voltage.
2. Remove the OptiFill dispenser from its fixture and swivel the dispenser arm to the upper position.
3. Remove the covering hood from the system by releasing the spring locks (page 8, Figure 1: "Front view of the OmniaPure system) and drawing the covering hood forwards.
4. The ultra pure water cartridge is at the standing position on the left and the pretreatment cartridge at the one on the right (see page 8, Figure 2: "View without the covering hood"). Open the quick connectors of the cartridge (see page 9, Figure 4: "Cartridge connectors") that needs to be replaced and remove it from the system.
5. Place the new cartridge in the system at the appropriate standing position. Make use of the half-round bulge in the main housing for easier positioning.
6. Close the cartridge to the system with the quick connectors.
7. Replace the covering hood and plug the OptiFill dispenser in its hold.
8. Replace the line plug in the line socket to start the system.
9. Finally rinse the system as described under "8 Putting into operation".

10.3 Disinfection

The OmniaPure should be disinfected at regular intervals (12 months) to protect it against biological deposits. A disinfection kit (article no. 19200056) and a disinfectant (article no. 19200057) are required for this.



Danger of explosion and burns!

Disinfection of OmniaPure systems is to be only carried out by appropriately qualified staff.

Protect yourself against harm by means of suitable safety clothing (protective gloves and eye protective glasses at the least).

Observe the instructions given by the safety data sheet that is supplied with the disinfectant and exactly follow the instructions given for handling the disinfectant.

Exclusively use disinfectant that has been approved for use with the OmniaPure system.

The disinfecting process is described in the following. It takes about 30 minutes.

Open the Disinfection menu item “Disinfection” in the System menu. Press the Enter button to start the disinfection process.

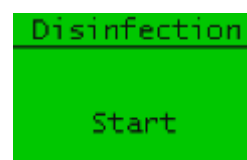

You will now be requested to fit the disinfection cartridge in the system. If you want to abort this process, press the Menu/Esc-button. If you want to continue, first prepare the disinfection cartridge with the disinfectant according the instructions that is supplied with them. Remove the ultra pure water cartridge from the system as described under “10.2 Cartridge replacement”. Replace it with the disinfection cartridge and fit the quick connectors on. Press the Enter button to confirm that the disinfection cartridge is in position.



The system now begins to circulate the disinfectant solution. When this circulation phase has finished, the system is automatically rinsed. The time remaining is displayed and the total process takes about 30 minutes. This process cannot be aborted. It must be allowed to go to completion.

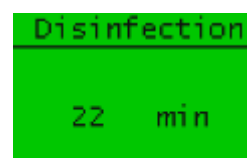

When disinfection has finished, you will be demanded to fit in a new ultra pure water cartridge. Follow the instructions given for cartridge replacement in “10.2 Cartridge replacement” and end the process with a push on the Enter button. The system now goes to “flush”.



Don't forget that the system has a new cartridge that has to be rinsed (see 10.2 Step 9).

11 Faults, Causes and Remedies

11.1 Automatic system monitoring

The OmniaPure System automatically carries out fault monitoring for several system parameters. When one of the monitored system parameters deviates from the entered stipulation, both an optical and an acoustic fault message are issued. In the case of a fault, the colour of the display changes to red and a warning signal is emitted (when it is active). The type of fault is shown by a corresponding output in the display. When the fault is for exceeding a limit value, the corresponding LED changes from green to red.



You can confirm an active fault message with the Enter button and so turn a warning signal off.

The individual fault messages are described here:

Fault “LF1!” is displayed when a limit value has been set in Setup for conductivity under “Limit Cond.” and this value has now been exceeded. The fault remains in the display until conductivity “LF1” is below the limit value.

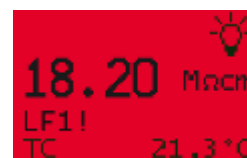

When a limit value has been set for LF2 and this has been exceeded, the fault “LF2!” is displayed. This fault “LF2” also comes to display when LF2 has a defect. The fault remains in the display until conductivity LF2 goes below the limit value or the defect is eliminated.



When a limit value for LF3 has been set, exceeding of this value is shown as an “LF3!” fault. When an LF3 defect occurs, fault “LF3!” will also be displayed. The fault will be shown until conductivity LF3 again goes below the limit value or the defect is remedied.



In OmniaPure UV, UV/UF, UV-TOC and UV/UF-TOC systems, a “UV!” fault is shown when there is an error with the UV-lamp.

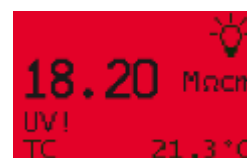

When a limit value has been set for the temperature, exceeding of this limit value is shown by “TMP!”. As soon as the temperature goes below the limit value, the fault is reset.

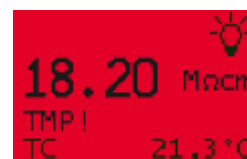

When the withdrawal solenoid valve of the OptiFill dispenser is subject to a defect (a cable break, for example) this is displayed as fault message “MVDIS!”. As soon as the fault has been remedied, the fault display is reset.



When the inlet solenoid valve has a defect, the fault message “MVIN!” is displayed. The fault display is reset as soon as the valve functions normally.

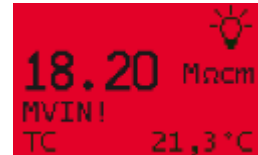

The fault message “MVFL!” indicates a rinsing solenoid valve defect. The fault display is reset as soon as the valve functions normally.

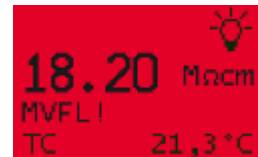

All OmniaPure systems are equipped with an internal leak sensor. Should water in the system leak out uncontrolled within the system, the “LEAKAGE!” message is shown. In addition, the system closes all valves, and possibly also deactivates the pump, to stop further flow of water. This fault can only be reset by a renewed start of the system when the leak has been stopped.

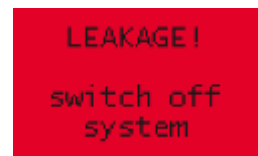

11.2 Table of faults

Fault	Possible cause	Remedy
System does not start / Nothing is shown in the display	No or faulty power supply	Make sure that the power supply fulfils "3 Technical data" requirements
Conductivity LF1 lastingly exceeds the set limit value / Fault LF1!	Pretreatment cartridge is exhausted	Replace with a new pretreatment cartridge
	Feedwater does not fulfill requirements	Check the feedwater quality
	Limit value for LF1 set too low	Check LF1 limit value setting
Conductivity LF1 is shown wrong and fault LF1! is displayed	Defect in conductivity measurement LF1	Please contact our customer service
Conductivity LF2 lastingly exceeds the set limit value / Fault LF2!	Ultra pure water cartridge is exhausted	Replace with a new ultra pure water cartridge
	Feedwater does not fulfill requirements	Check the feedwater quality
	Limit value for LF2 set too low	Check LF2 limit value setting
Conductivity LF2 is shown wrong and fault LF2! is displayed	Defect in conductivity measurement LF2	Please contact our customer service
Conductivity LF3 lastingly exceeds the set limit value / Fault LF3!	Ultra pure water cartridge is exhausted	Replace with a new ultra pure water cartridge
	Feedwater does not fulfill requirements	Check the feedwater quality
	Limit value for LF3 set too low	Check LF3 limit value setting
Conductivity LF3 is shown wrong and fault LF3! is displayed	Defect in conductivity measurement LF3	Please contact our customer service
Temperature lastingly exceeds the set limit value / Fault TMP!	Limit value for temperature is set too low	Check the temperature limit value setting and the feedwater temperature
	System is set for permanent circulation or the pause between the circulation phases is set too low	Increase the Pause parameter value in the circulation setting
UV lamp does not function / Fault UV!	UV lamp is defect	UV lamp must be replaced
	Maximum operating time has been exceeded	
Water leaks uncontrolled out / Fault LEAKAGE!	Leaky hose connection or components	Switch the system currentless by pulling the line plug out and contact customer service
The system does not carry out rinsing	The rinsing solenoid valve is defect. Fault "MVFL!" is shown.	Please contact technical service

No water can be withdrawn	System receives no feedwater	Check the hose connections of the feedwater supply. Open the in-house feedwater supply.
	Inlet pressure too low	Check the inlet pressure (feedwater pressure) and increase it if appropriate.
	Leak sensor reacts / Fault LEAKAGE! is shown	If the leak sensor contacts water, the inlet solenoid of the system will close to prevent further emergence of water. Stop the leak, reset the fault with a new start of the system.
	The inlet solenoid valve is defect. Fault "MVIN!" is shown.	Please contact technical service
	The withdrawal solenoid valve is defect. Fault "MDIS!" is shown.	Please contact technical service
Withdrawal performance is too small	Inlet pressure is too low	Check the inlet pressure and increase it if appropriate.
	Ultrafiltration module is blocked	The ultrafiltration module must be replaced
	The set system pressure is too low	Newly reset the internal system pressure reducer.

12 Consumables and accessories

Consumable / Accessory	Article number
Pretreatment cartridge OmniaPure	19200002
Ultra pure water cartridge Omnia 055	19200003
Sterile filter capsule 0.2µm	19100300
Bio-Endfilter	19102100
UV replacement lamp, 185nm	19200055
Ultrafiltration module	19000050
Disinfections kit Omnia	19200056
Disinfectant Omnia – Pack of 3.	19200057
Wall mount Omnia	19200300

13 Waste disposal

If the packaging of the system is no longer required, dispose of it in the household waste.



According to the WEEE-Richtlinie, waste disposal in the household waste of electrical and electronic waste is not permissible. In Germany and other members of the European Economic Area please contact the local customer service or our headquarters at the address given below for information on the waste disposal of this system and any accessories.

stakpure GmbH
 Auf dem Kesseling 11
 D – 56414 Niederahr

WEEE-Reg.-Nr. DE 16914291

In countries outside of the European Economic Area, please contact the local waste management officials or companies.



EEC-Declaration of Conformity

acc. to :

- EEC-Directive 2006/42/EG
- EEC-Low Voltage Directive 2014/35/EU
- EEC Electromagnetic Compatibility Directive 2014/30/EU

stakpure GmbH

Auf dem Kesseling 11

D-56414 Niederahr

Telefon: 02602 10673-0 Telefax: 02602 10673-200

info@stakpure.de www.stakpure.de

We hereby declare that the products named below conform in their design and construction, as well as in the versions we have brought to market, to the fundamental safety and health requirements of EEC-Directive 2006/42/EG.

This declaration is invalidated should changes not agreed to by us are made to the product.

Design of the product: High purity water system

Product Typ: OmniaPure, OmniaPure UV, OmniaPure UV/UF,
OmniaPure UV-TOC, OmniaPure UV/UF-TOC

Item no.: 18200001, 18200002, 18200003, 18200004, 18200005

Standards applied: DIN EN ISO 12100:2011-03
DIN EN 61326-1:2013
DIN EN 55011
DIN EN 61000

Niederahr, 17.05.2017

Leo Trumm,

A handwritten signature in black ink, appearing to read 'Leo Trumm'.

authorized representative of the manufacturer

stakpure

stakpure GmbH

Auf dem Kesseling 11

D – 56414 Niederahr

Tel.: +49 2602 10673-0

Fax: +49 2602 10673-200

info@stakpure.de

www.stakpure.de