

memmert

EXCELLENT

**Waterbath
WNE 7-45
WPE 45**

**Oilbath
ONE 7-45**

Operating Instructions



1	General notes and safety notes.....	4
1.1	Transport.....	4
2	Technical data	5
2.1	Material quality	6
2.2	Electrical equipment	6
2.3	Note on EMC (electromagnetic compatibility).....	6
2.4	Brief technical description	6
2.5	Standard equipment.....	7
3	Installation.....	7
3.1	Initial start-up.....	8
3.2	Installation - waterbaths	8
3.3	Installation - oilbaths	9
4	Bath construction and operation	10
4.1	Controls and indications	10
4.2	Switching on	11
4.3.1	Temperature setpoint.....	12
4.3.2	Delayed switch-on	12
4.3.3	Hold time of the setpoint temperature.....	13
4.3.4	Setpoint-dependent waiting time.....	13
4.3.5	Circulating pump (WPE 45 only)	14
4.3.6	Temperature monitor	15
4.3.7	Level monitor	15
4.3.8	Setup menu.....	15
4.3.8.1	Calibration.....	16
4.3.8.2	Selection of temperature monitor (waterbaths only).....	17
5	Programming example of a programme sequence	17
6	Monitoring the programme sequence	18
7	Temperature monitor and protection devices	19
7.1	Mechanical temperature monitor: temperature limiter	19
7.2	Electronic temperature monitor	19
7.2.1	Adjustable temperature monitor (TWW) Protection Class 3.1 to DIN 12880.....	20
7.2.2	Adjustable temperature limiter (TWB) Protection Class 2 to DIN 12880.....	20
7.3	Monitor relay.....	20
8	Use of the cover (special equipment)	21
9	Level control (special equipment).....	21
10	Cooling system (special equipment).....	22
11	Cleaning and maintenance.....	22
12	Check list for fault rectification	23
13	Action on supply failure	23
14	Glossary.....	23
15	CE Conformity of Declaration	24
16	Address and customer service.....	25
17	Index	26

1 General notes and safety notes

You have purchased a technically fully proven product which has been produced in Germany with the use of high-grade materials and the application of the latest manufacturing techniques; it has been factory tested for many hours.

In addition we guarantee the supply of spare parts over 10 years.



This mark in the Operating Instructions means:
Watch out
Important Note



This mark on the product means:
Note Operating Instructions
Warning – bath hot when operating



Observation of the Operating Instructions is necessary for faultless operation and for any possible claims under warranty. If these Instructions are disregarded, all claims under warranty, guarantee and indemnification are excluded.

The right to technical modifications is reserved.
Dimensional details are not binding.

1.1 Transport

Always use gloves!

If the units W./O.. 22 to 45 have to be carried, at least 2 persons are required for this mode of transport.



Place the bath accurately horizontal and not on an inflammable support.

2 Technical data

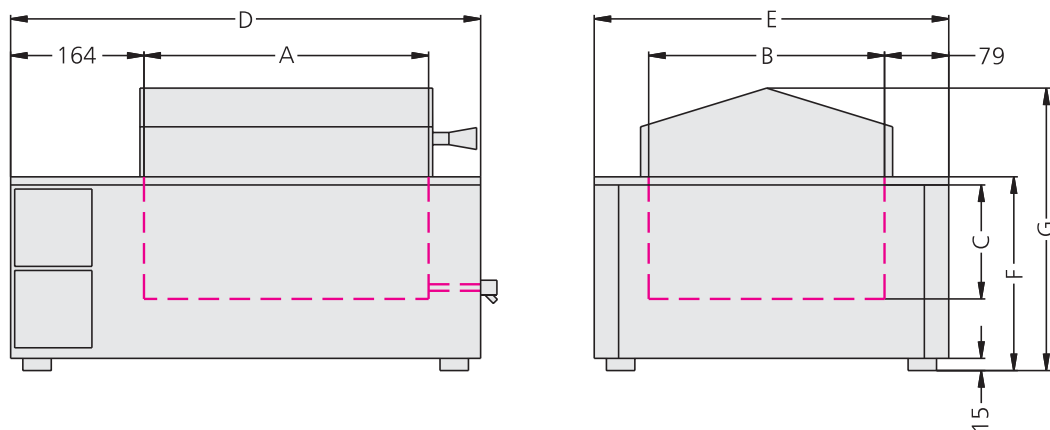

Model	7	10	14	22	29	45
Volume [liter]	7	10	14	22	29	45
Usable bath length A [mm]	240	350	350	350	590	590
Usable bath width B [mm]	210	210	290	290	350	350
Usable bath depth C [mm]	140	140	140	220	140	220
Housing length D [mm]	468	578	578	578	818	818
Housing width E [mm]	356	356	436	436	516	516
Housing height (with flat cover) F [mm]	238	238	238	296	238	296
Housing height (with gable cover) G [mm]	337	337	347	405	343	401
Weight [kg]	11	14	16	17	24	26
Current consume [A]	5,2	5,2	7,8	8,7	10,4	12,2
Power [W]	1200	1200	1800	2000	2400	2800
Ambient conditions	Ambient temperature 5°C - 40°C rh max. 80% Overvoltage Category: II Contamination degree: 2 according to IEC 664					
Setting temperature range	10°C to 95°C on waterbaths with activation of the boiling mode to 100°C, see section 4.3.1 20°C to 200°C on oilbaths					
Setting accuracy:	0,1°C					
Indication accuracy	0,1°C					
Working temperature range	From 5°C above ambient temperature on water- and oilbaths or 15°C above ambient temperature on waterbaths with circulating pump to nominal temperature = maximum temperature (see rating plate)					

2.1 Material quality

Memmert is using stainless steel (Mat.Ref. 1.4301) for the external casing as well as for the interior, an outstanding material because of its high stability, optimum hygienic features and corrosion resistance against many (not all!) chemical combinations (Attention e.g. at chlorine combinations!).

The thermofluid has to be tested for its chemical compatibility with the materials mentioned above. A compatibility table covering all these materials can be requested from MEMMERT.



WARNING! Always pull out the supply plug before opening the bath cover!

2.2 Electrical equipment

- Operating voltage see rating label 50/60 Hz, WPE 45: 50Hz
- Protection Class 1, i.e. operating isolation with ground connection to EN 61 010
- Protection IP20 to DIN EN 60 529
- Interference suppression to EN55011 Class B
- Bath protected by a fuse 250V/15A fast blow
- Controller protected by a 80 mA fuse (200 mA on 115 V)
- When connecting a MEMMERT bath to the electrical supply you have to observe any local regulations which apply (e.g. in Germany DIN VDE 0100 with FI protection circuit)

2.3 Note on EMC (electromagnetic compatibility)

This product is intended to operate on a supply network with a system impedance Z_{max} at the transfer point (building connection) of 0.292 Ohm max. The user has to ensure that the product is only operated on an electrical supply network which meets these requirements. If necessary, details of the system impedance can be obtained from the local electricity supply authority.

Note:

Any work which involves opening up the bath must only be carried out by a properly qualified electrician

2.4 Brief technical description

MEMMERT-water and oilbaths are electrically heated and electronically controlled.

The temperature of the thermostating liquid is continuously controlled by a microprocessor-controller with pulse package control. Electronic microprocessor-PID-controller with continuous power matching and autodiagnostic system with fault indicator (see section 12), integral timer for digital programme time selection.

The temperature is measured using a Pt100 temperature sensor. The accuracy is as follows:

	WNE	ONE
Setting accuracy	0,1°C	0,1°C
Temperature fluctuation	±0,1°C	±0,2°C

The components of temperature control are controlled by integrated malfunction-recognition. The heaters are installed outside - therefore no problems through dirt or limesidue.

2.5 Standard equipment

- Electronic fuzzy-supported PID process controller with delayed programme start and programmable hold time. The controller has permanent power matching and an autodiagnostic system for rapid fault finding
- Recessing push/turn control for simple operation of bath
- Visual alarm indication
- Mechanical temperature limiter (TB Class 1)
- Monitor relay to switch off heating in case of fault
- Boiling mode for temperatures above 95°C
- Setpoint-dependent waiting time
- Digital overtemperature monitor (on waterbaths choice between TWB Class 2 or TWW Class 3.1, on oilbaths TWB Class 2)
- Additional digital display of monitoring temperature
- Two separate, stainless-steel Pt100 temperature sensors (Mat.Ref. 1.4571) Class A in 4-wire circuit for control and monitoring
- Built-in sounder as alarm on overlimit, as audible signal at programme end, and to acknowledge input (key click)
- Warning at low liquid level
- Convenient calibration directly on the controller at one freely selected temperature
- Manually switched circulating pump, also pump switch-off at programme end (WPE45 only)

Special equipment (to be ordered separately as accessory): flat cover with concentric ring sets, gable cover to drain condensate, cooling device, various racks for test tubes, bottles etc.

3 Installation

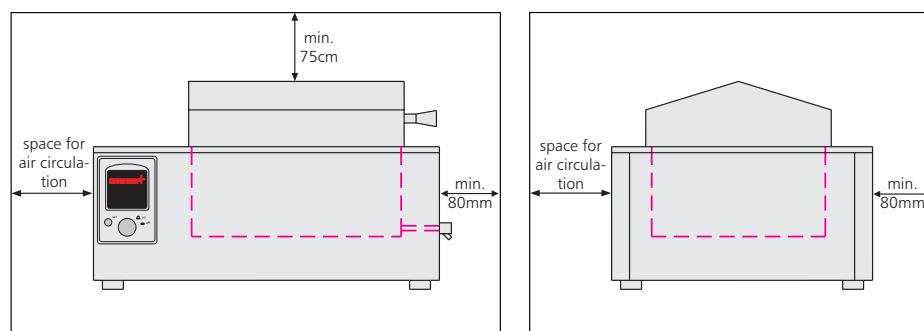

The unit must be placed on a **level surface** which cannot tilt.

The vent openings in the left and back side **must** remain unobstructed. Minimum wall spacing on all sides is 80 mm. The minimum spacing from the top of the bath to the next ceiling (rack, etc.) is 75 cm.

3.1 Initial start-up

When the bath is started up for the first time, it should be supervised continuously until steady conditions have been reached.

3.2 Installation - waterbaths

Mains connection The mains connection cable must be placed away from any hot surface.

Filling

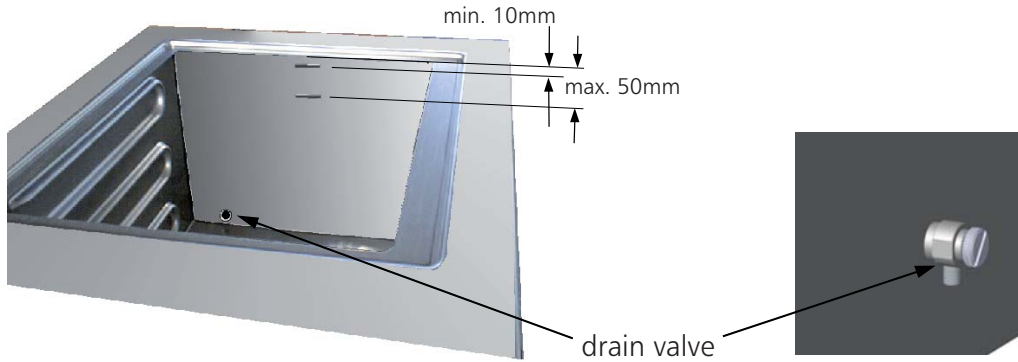

In order to guarantee the high quality of the stainless steel it is recommended by the steel producer to fill the waterbath with **deionised** water.

IMPORTANT! The water level in the bath must be between the two markings in the right side wall of the tub. The spacing between top edge of waterbath and liquid level must be at least 10 mm and not more than 50 mm.

Waterbaths can be fitted with a level control system (see section 9).

Draining

The tank can be drained through the drain valve. The thermostating fluid must be cooled to room temperature before draining. Drain the fluid either directly into an appropriate container or connect an appropriate hose to the drain valve.

NOTE: Polluted fluids may not be drained directly into the public wastewater system. If the thermostating fluid is polluted, please make sure that it will be properly filtered or dumped according to the applicable regulations.



Operation with non-flammable thermostating liquids only!

3.3 Installation - oilbaths

Mains connection

The mains connection cable must be placed away from any hot surface.

Filling

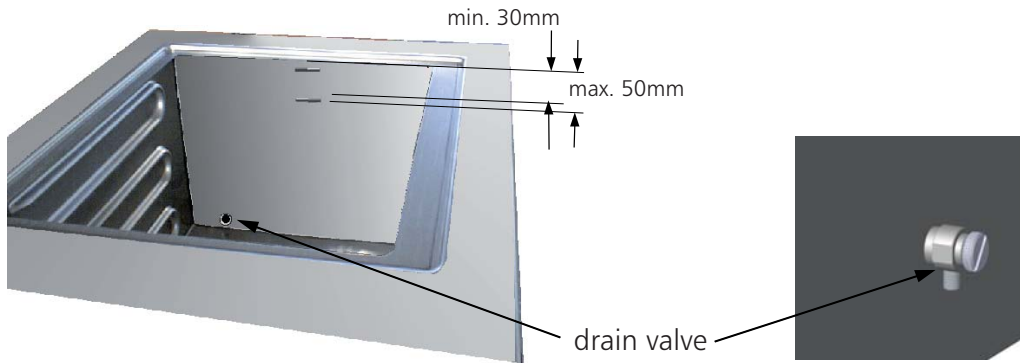

IMPORTANT! The liquid level in the bath must be between the two markings in the right side wall of the tub. The spacing between top edge of oilbath and liquid level must be at least 30 mm and not more than 50 mm **as the oil expands strongly on heating.**

Draining

The tank can be drained through the drain valve. The thermostating fluid must be cooled to room temperature before draining. Drain the fluid either directly into an appropriate container or connect an appropriate hose to the drain valve.

NOTE: Polluted fluids and oils may not be drained into the public wastewater system. Please make sure, that the oil will be properly dumped according to the applicable regulations.

For safety reasons the flash point of the oil must be at 300°C or higher. The manufacturer of the oil may also have special regulations for oil-changing intervals due to pollution or aging of the oil which have to be observed.



In case of fire never extinguish with water.
Use a suitable damping-down medium (e.g. fire blanket)!
An overheated bath must never be refilled or topped up!!



Warning - bath hot when operating

4 Bath construction and operation

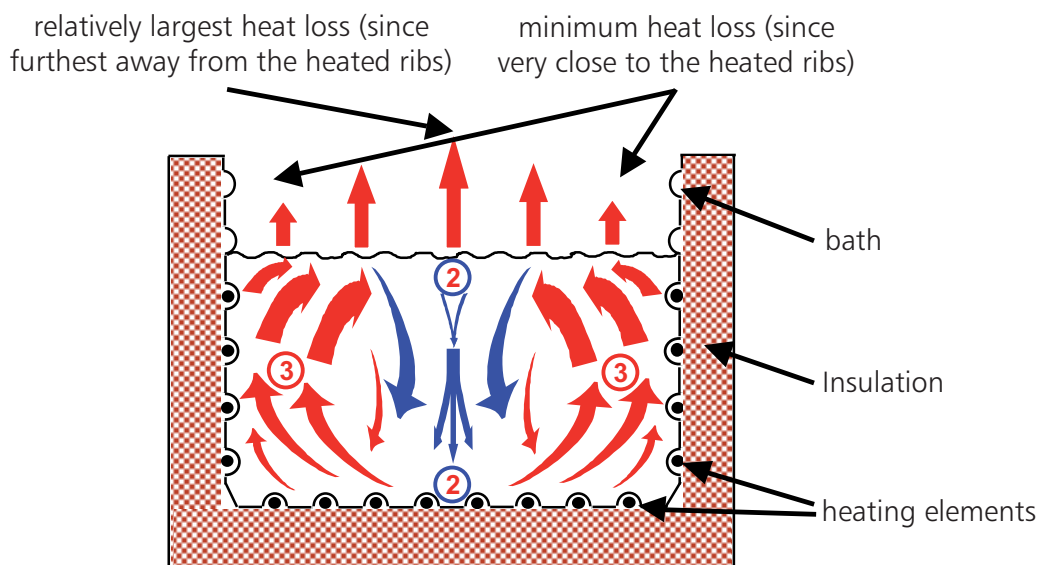

The large-area heating positioned on three sides produces a natural, continuous water circulation. The illustration shows that the heat loss of the thermofluid is largest at the centre of the bath (1) since the liquid is furthest away from the heating at this point. In this way the liquid at the bath centre is coolest and sinks to the bottom. The water is therefore close to the heating (2). This heats the water again so that it rises (3). The result is a continuous circulation and uniform temperature distribution.

4.1 Controls and indications

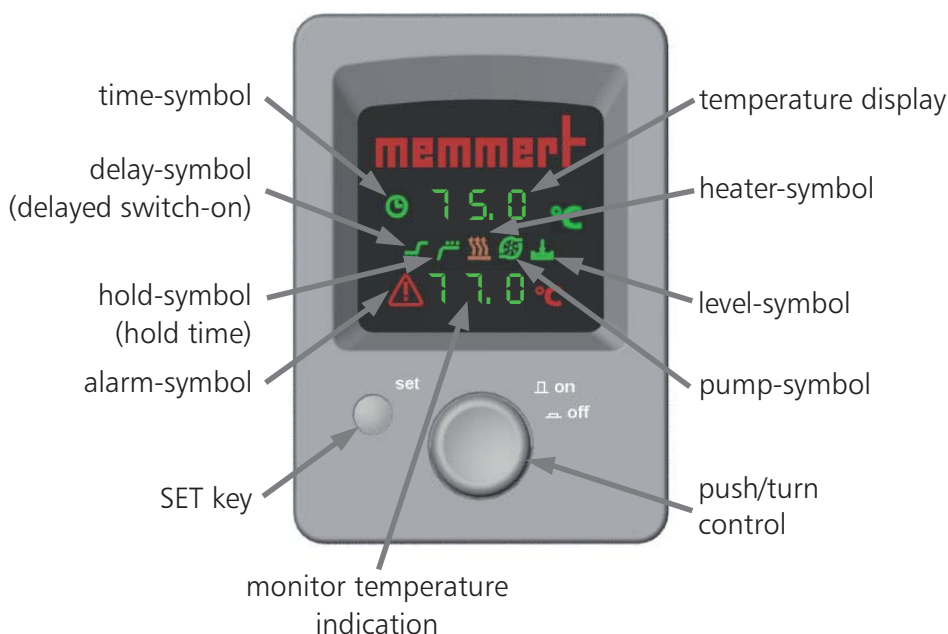

4.2 Switching on

The bath is switched on by pressing the push/turn control.

Bath switched off. The push/turn control is pushed in and protected against damage.

Bath switched on and can be operated using the push/turn control and the SET key.

4.3 Setting the parameters

A parameter can be selected by rotating the push/turn control; all other parameters are then dimmed. The selected parameter flashes brightly and can now be altered with the push/turn control while holding down the SET key (protection against unintentional alteration).

If the push/turn control is rotated quickly the setpoint is altered in large steps; with slow operation it is altered in single steps.

After the SET key has been released the newly set value is stored.

Further rotation of the push/turn control selects the next parameter.

Rotation of the push/turn control selects the following parameters (in the order indicated), to be altered as described above:

1. Temperature setpoint
2. Delayed switch-on
3. Hold time of the setpoint temperature
4. Setpoint-dependent waiting time
5. Circulating pump (WPE 45 only)
6. Temperature monitor

4.3.1 Temperature setpoint

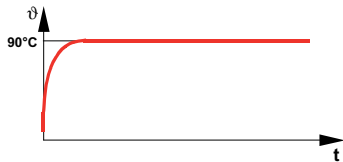

The bath starts to heat up immediately to the set temperature.

Adjustment range:

waterbaths: 10°C to 95°C or ca. 100°C with activation of the boiling mode

oilbaths: 10°C to 200°C

Setting and indication accuracy:

water-/oilbaths: 0.1°C

Rotate the push/turn control until the  symbol flashes.

The setpoint temperature can then be selected with the SET key depressed, as described in Section 4.3. After releasing the SET key the display briefly flashes the setpoint. The display then changes to the actual temperature and the controller starts to control to the selected setpoint temperature.

During heating the  symbol flashes in proportion to the actual heater power.

Waterbaths only:

In order to reach water temperatures above 95°C (boiling point), waterbaths are provided with the boiling mode. If this is selected, the heating is switched on permanently.

Activating the boiling mode by rotating the push/turn control beyond the maximum value until the display shows "CCC°C"

The setting "boiling mode" is not stored permanently. After the bath is switched off and on again, the controller shows again the previously selected setpoint..



4.3.2 Delayed switch-on

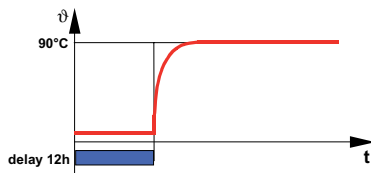

The bath starts to heat up to the previously selected temperature only after the time of the switch-on delay has elapsed.

Adjustment range:

1 min bis 999 hrs

Setting accuracy:

< 100 hrs: 1 min

≥ 100 hrs: 1 hr

Indication accuracy:

< 10 hrs: 1 min

≥ 10 hrs: 1 hr

Rotate the push/turn control until the  (delay) and the  symbol flashes.

The duration of the delayed switch-on can then be set with the SET key depressed as described in Section 4.3. After the SET key has been released the bath briefly flashes the setting of the switch-on delay.

The switch-on delay is then activated and the display alternates between the actual temperature and the running time of the switch-on delay. The time is shown with a negative sign and runs down. In this way it is possible to determine at any time how much longer the bath waits until it begins to heat up.

If no delayed switch-on is required, it can be de-activated by the setting "OFF".



4.3.3 Hold time of the setpoint temperature

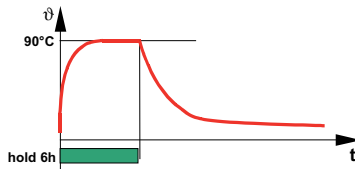

The bath switches off the heating after the end of the selected hold time. In this case the hold time includes the heating-up time..

Adjustment range:

1 min bis 999 hrs

Setting accuracy:

< 100 hrs: 1 min

≥ 100 hrs: 1 hr

Indication accuracy:

< 10 hrs: 1 min

≥ 10 hrs: 1 hr

Rotate the push/turn control until the  (hold) and the  symbol flashes.

The duration of the hold time can then be selected with the SET key depressed, as described in Section 4.3. After the SET key has been released the bath briefly flashes the hold time setting.

If no hold time has been programmed, the hold time is activated immediately and the display alternates between the actual temperature and the running time of the hold time. As with switch-on delay, the residual time is shown with a negative sign and runs down.

If no hold time is required, it can be de-activated by the setting "OFF".

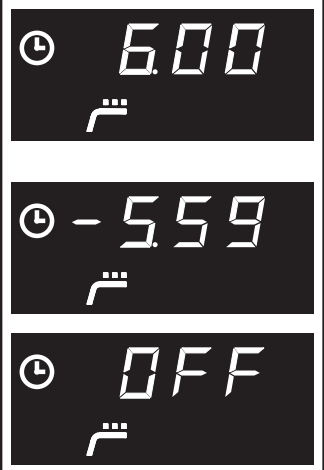

4.3.4 Setpoint-dependent waiting time

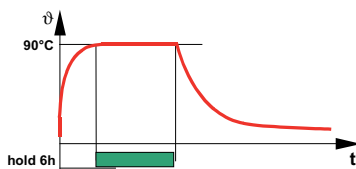

The bath switches off the heating after the selected hold time has elapsed. The hold time begins only when the setpoint temperature has been reached.

Setting:

ON or OFF

Rotate the push/turn control until  flashes.

With the SET key depressed, the setpoint-dependent waiting time can be activated or de-activated.

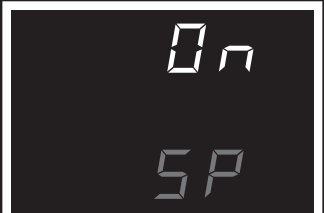

4.3.5 Circulating pump (WPE 45 only)

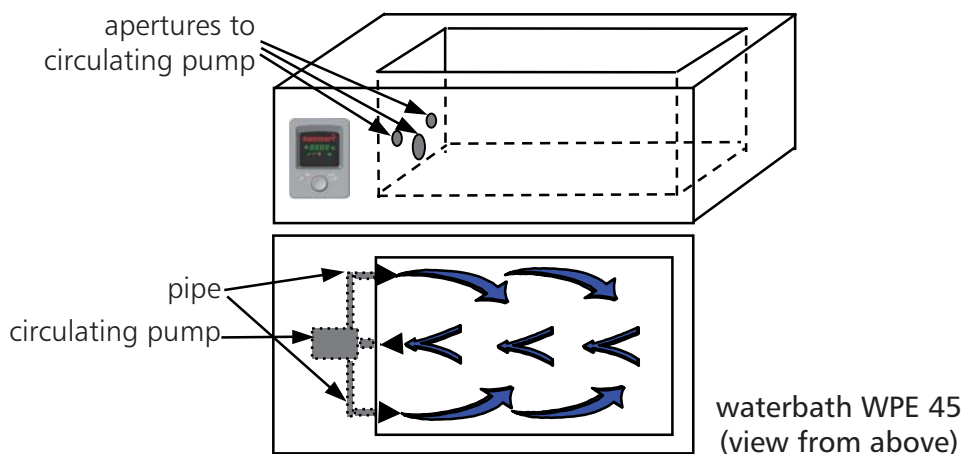

Operation of a circulating pump can improve the temperature distribution inside the waterbath. The pump draws water from the centre of the bath and distributes it through the pipes in the front and back of the bath. The continuous water circulation avoids larger temperature differences. At a water temperature of e.g. 90°C the temperature difference in the entire bath is less than 0.36°C.

Note:

If the boiling mode “☐ ☐ ☐” has been activated, circulating pump operation is not possible!

Setting:
ON or OFF

Rotate the push/turn control until the  symbol flashes.

With the SET key depressed the circulating pump can then be switched on and off.



4.3.6 Temperature monitor

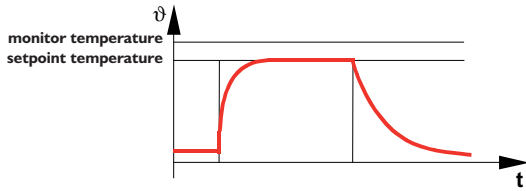

Adjustment range:
up to 10°C above nominal temperature

Setting and indication accuracy:
< 100°C: 0.1°C
≥ 100°C: 1°C

(see also sections 4.3.8.2 and 7)

<p>Rotate the push/turn control until the monitor temperature display flashes.</p> <p>The monitor temperature can then be adjusted with the SET key depressed, as described in section 4.3. While the SET key is depressed, the top display shows for information the previously selected setpoint temperature.</p> <p>It is important to ensure that the monitor temperature is always set sufficiently high above the maximum working temperature.</p>	
--	--

4.3.7 Level monitor

<p>When the liquid level has fallen so far that the upper of the two Pt100 temperature sensors is above the bath liquid, the different temperatures inside and outside the bath liquid cause the  symbol to flash, the sounder operates, and the heating is switched off for safety reasons.</p> <p>On topping up the liquid, ensure that the liquid level is between the two level marks on the right inside the bath. (see also Sections 3.2 and 3.3)</p> <p>The bath is again ready for operation after switching it off and on or after pressing the SET key.</p>	
--	--

4.3.8 Setup menu

<p>The setup menu provides additionally for a single-point calibration and the choice of temperature monitor.</p> <p>To get to the setup menu the SET key has to be depressed while the bath is switched on.</p> <p>After switching on, the display shows the version of the controller software.</p>	
---	--

4.3.8.1 Calibration

Customer calibration of the bath on the controller using a self-selected calibration temperature. A positive or negative calibration difference against it can be set.

General calibration instructions:

1. Set the required calibration temperature and set the calibration difference to 0.0°C (see below "set calibration temperature" and "set calibration difference").
2. Measure the deviation from the selected calibration temperature under steady conditions, using a reference instrument.
3. Set the calibration difference. If the measured reference temperature is lower than the indicated value, the calibration difference has to be set with a negative sign.
4. Carry out a check measurement using the reference meter.

Beispiel: Temperature difference between controller display (e.g. 70.0°C) and bath liquid (e.g. 69.0°C) has to be corrected.

1. Set calibration temperature to 70.0°C and set calibration difference to 0.0°C .
2. Using a calibrated reference instrument, the measured temperature is 69.0°C at a setpoint temperature of 70.0°C .
3. Set calibration difference to -1.0°C .
4. After the bath has settled down the reference instrument should read 70.0°C .

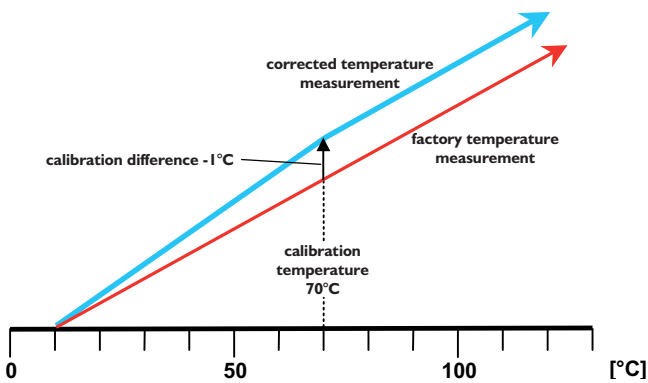

Adjustment range: calibration temperature:

waterbaths: 10°C to 95°C

oilbaths: 10°C to 200°C

Adjustment range: calibration difference:

water-/oilbaths: -5.0°C to 5.0°C

Set calibration temperature:

Rotate the push/turn control until **CAL** flashes.

The calibration temperature can then be set with the SET key depressed as described in section 4.3.

Set calibration difference:

Rotate the push/turn control until **dIFF** flashes.

The calibration difference can then be set with the SET key depressed as described in section 4.3.

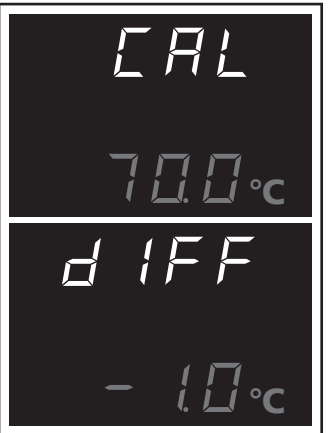

Note:

Setting the calibration difference to 0.0°C restores the factory calibration!

4.3.8.2 Selection of temperature monitor (waterbaths only)

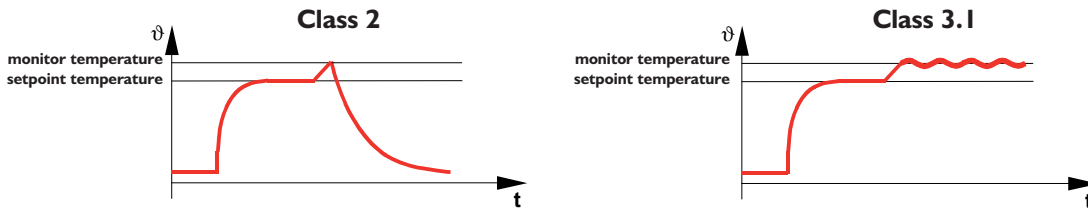













Setting:
2 or 3.1

Rotate the push/turn control until **SAFE** flashes.



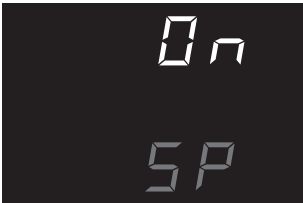







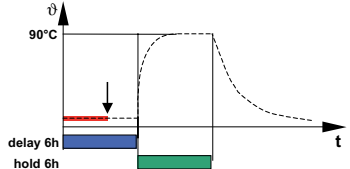



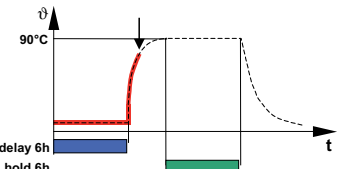

With the SET key depressed it is possible to select the temperature monitor as adjustable temperature limiter (TWB) Protection Class 2 to DIN 12880, or as adjustable temperature monitor (TWW) Protection Class 3.1 (see also sections 4.3.6 and 7)

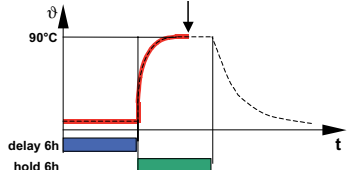

5 Programming example of a programme sequence

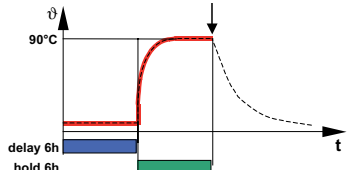
<p><u>1. Setpoint temperature setting</u></p> <p>Rotate the push/turn control until the  symbol flashes. With the SET key depressed, use the push/turn control to set the temperature setpoint to 90.0°C</p>	
<p><u>2. Delayed switch-on setting</u></p> <p>Rotate the push/turn control until the  (delay) and the  symbol flashes. With the SET key depressed, use the push/turn control to set the time 6.00</p>	
<p><u>3. Hold time setting</u></p> <p>Rotate the push/turn control until the  (hold) and the  symbol flashes. With the SET key depressed, use the push/turn control to set the time 6.00</p>	
<p><u>4. Setpoint-dependent waiting time setting</u></p> <p>Rotate the push/turn control until SP flashes. With the SET key depressed, use the push/turn control to set 0.7.</p>	
<p><u>5. Switch on the circulating pump (WPE 45 only)</u></p> <p>Rotate the push/turn control until the  symbol flashes. With the SET key depressed, use the push/turn control to set 0.7.</p>	
<p><u>6. Monitor temperature setting</u></p> <p>Rotate the push/turn control until the monitor temperature display flashes. With the SET key depressed, use the push/turn control to set the monitor temperature to 91.5°C</p>	

6 Monitoring the programme sequence

 <p>Bath does not heat up</p>	<p>During the delayed switch-on the  symbol flashes and the display alternates between residual time and actual temperature</p>	 <p>↑</p> 
 <p>Bath heats up to setpoint temperature</p>	<p>SP activated:</p> <p>After the end of the delayed switch-on the  symbol goes dark and the bath heats up to the selected setpoint temperature. The display alternates between actual temperature and "SP" until the setpoint temperature is reached. Heating is indicated by the  symbol.</p>	 <p>↑</p> 
 <p>Bath holds setpoint temperature</p>	<p>SP is de-activated or after the setpoint temperature has been reached:</p> <p>During the hold time the  symbol flashes and the display alternates between the residual time and the actual temperature.</p>	 <p>↑</p> 
 <p>Heating is switched off</p>	<p>After the hold time has elapsed the  symbol goes dark, the heating is switched off, and the display alternates between the actual temperature and "END".</p>	 <p>↑</p> 

7 Temperature monitor and protection devices

The monitor temperature is measured with a separate Pt100 temperature sensor inside the chamber. The monitor unit provides protection for the bath load as well as protection for bath and its surroundings.

The bath is provided with duplicate overtemperature protection (mechanical / electronic) according to DIN 12880.

7.1 Mechanical temperature monitor: temperature limiter

All water- and oilbaths are fitted with a mechanical temperature limiter (TB) Protection Class 1 to DIN 12880.

If the electronic monitor system should fail during operation and the fixed factory-set maximum temperature is exceeded by approx. 30°C the temperature limiter switches off the heating permanently as a final protective measure. The  symbol lights up continuously as fault indication.

In addition to its function as overtemperature protection the TB also operates as low-level protection, i.e. the heating is switched off permanently if the liquid drops below a certain level.

Fault rectification after the TB cut-out has been activated:

1. Switch off the bath and allow it to cool down
2. Rectify the fault (e.g. top up the liquid, replace temperature probe) and where appropriate contact customer service
3. The bath is again ready for operation only after it has cooled down and after the fault has been rectified

7.2 Electronic temperature monitor

<p><u>Monitor temperature</u> Adjustment range: up to 10°C max above nominal temperature (for nominal temperature see rating label)</p>		<p>Using the push/turn control select the monitor temperature. With the SET key depressed, use the push/turn control to set the monitor temperature.</p>
---	---	--

Note:

The monitor temperature must always be set sufficiently high above the maximum working temperature.

The manually selected monitor temperature of the electronic overtemperature protection is monitored in the case of waterbaths either by an adjustable temperature monitor (TWW) Protection Class 3.1 to DIN 12880 or by an adjustable temperature limiter (TWB) Protection Class 2 to DIN 12880, and in oilbaths by an adjustable temperature limiter (TWB).

On waterbaths the temperature monitor can be selected in the setup menu (see section 4.3.8 or 4.3.8.2). For details of temperature monitor and protection class see rating label.

7.2.1 Adjustable temperature monitor (TWW) Protection Class 3.1 to DIN 12880

If the manually set monitor temperature is exceeded, the TWW takes over the control of the temperature and starts to control at the monitor temperature. The  symbol flashes as warning.

7.2.2 Adjustable temperature limiter (TWB) Protection Class 2 to DIN 12880

If the manually set monitor temperature is exceeded, the TWB switches off the heating permanently and can only be reset by pressing the SET key. The  symbol flashes as warning.

7.3 Monitor relay

In addition the bath is equipped with an electronic monitor relay.

If a fault occurs during operation or if the selected setpoint temperature is exceeded by 10°C, then the monitor relay continues control of the heating at this temperature in emergency operation. The  symbol flashes as warning.

Fault rectification after the monitor relay may be activated:

Check the controller for error messages (see section 12) and where appropriate contact customer service.

Example:

With a setpoint temperature of 80°C, if a fault occurs in the power unit (faulty triac) the bath continues to operate in emergency operation at approx. 90°C.

8 Use of the cover (special equipment)

Gable cover The gable cover (may be ordered as already mounted special equipment) should always be closed in order to prevent evaporation of thermostating liquid and to obtain optimal temperature distribution. The gable shape of the cover makes sure that condensed water will not drop down into the loads.

Flat cover For positioning of test flasks on top of the bath, a flat cover (special equipment) may be used. The size of the holes in this cover can be adapted to the flasks with ring inserts. The rings may therefore only be inserted or taken off, if the bath is cooled down.



Note that during operation the flat cover and the gable cover heat up to the temperature of the thermofluid!

9 Level control (special equipment)

2 different filling levels can be maintained constant if the unit is fitted with a level control system. When using water as thermostating liquid, connect the feed pipe with tubing to the mains water supply. The drain must be connected with tubing to an appropriate container or sink.

Make sure, that the tubing cannot be clogged or bended, and that it continually runs downhill.

Please note, that the overflowing water may be up to 100°C hot!

Supply and drain are indentified by arrows. Use temperature resistant material for the tubing.

If the second overflow is not required, it must be closed with a sealing cap.

The evaporation loss can be compensated through a slightly open water supply (dripping) and can be monitored through the "observation window".

The level control system cannot be retrofitted!

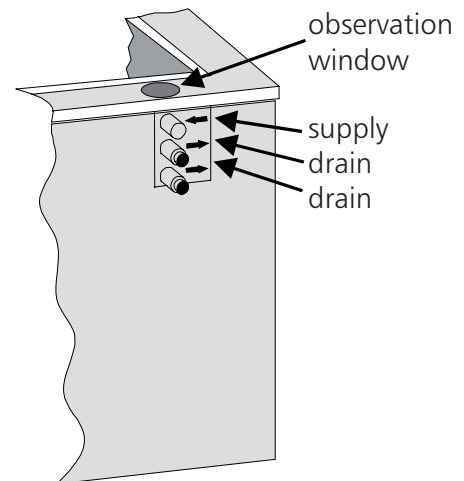

Warning – bath hot when operating

10 Cooling system (special equipment)

If the waterbath is fitted with a cooling device for quicker cooling of the bath liquid, the "cold water supply" has to be connected by a hose to a cold water supply line. The "warm water discharge" has to be run by a hose to a drain.

Use temperature resistant material for the tubing.

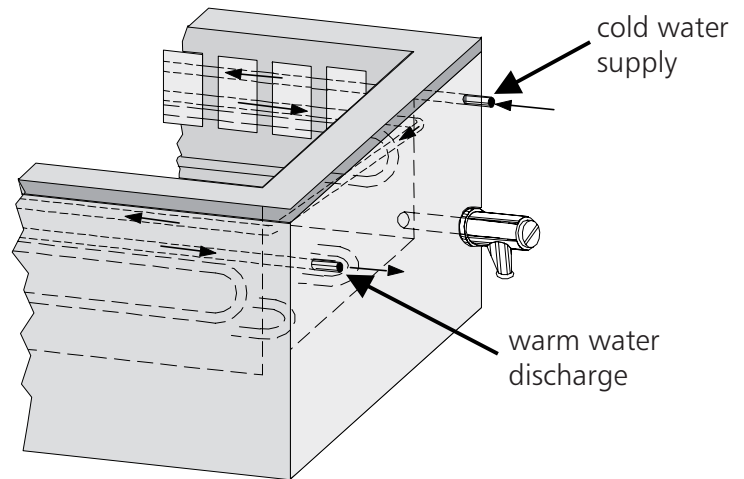

Please note, that the overflowing water may be up to 100°C hot!

The overflow must be connected with tubing to an appropriate container or sink. Make sure, that the tubing cannot be clogged or bended, and that it continually runs downhill.

11 Cleaning and maintenance



By regular cleaning of the easy to clean the tank, residues are avoided which at continuous influence can impair the outfit and function of the water-/oilbath. Before using any other method for cleaning or detoxicating than recommended by the manufacturer, the user has to contact the manufacturer in order to make sure that this chosen method will not destroy the appliance.





The unit can be cleaned with commercial stainless steel cleaning agent. It is important to ensure that no rusting objects come into contact with the stainless steel bath tank or the stainless steel housing. Rust sediments lead to contamination of the stainless steel tank or external casing.

If rust stains caused by contamination occur on the tank surface, the affected areas must be cleaned and polished immediately.

Limeresidues can be removed by vinegar or citron-solutions.

On units with gable cover we recommend that the hinge bolts are oiled from time to time if the bath is used frequently.

12 Check list for fault rectification

Main switch ON, no indication on the display	Main fuse 15A or instrument fuse T80mA 250V~ on circuit board 55167.x has blown Controller faulty Electrical supply interrupted
 symbol not alight	Ambient temperature too high Temperature in bath above the selected setpoint temperaturer
 symbol alight	Temperature protection (TB) has operated
 symbol flashes	Temperature protection (TWW/TWB) has operated Monitoring relay has operated
 symbol flashes	Liquid level too low
CONF	Error on self test
E - 1	Power module triac faulty
E - 2	Power module faulty
E - 3	Pt100-temperature probe faulty
E - L	Communication to power unit interrupted

In case of a malfunction contact an authorized service station for Memmert equipment or please inform the Memmert service department.

In case of queries always specify model and serial number (on the rating label)

13 Action on supply failure

After a failure of the supply, operation continues with the previously set parameters.

14 Glossary

- nominal temperature = the maximum adjustable setpoint temperature of the bath.
- ambient temperature = the continuous temperature of the room in which the bath is set up
- setpoint temperature dependent on operation = the integrated digital timer for the hold time starts no earlier than the temperature in the bath has reached the setpoint to least 0.5°C at 95°C nominal temperature resp. 2°C at 200°C nominal temperature.



EC Declaration of Conformity

Manufacturer's name and address: MEMMERT GmbH + Co. KG
Äußere Rittersbacher Straße 38
D-91126 Schwabach

Product: Waterbath / Oilbath

Type: WNE ... / ONE ... / WPE 45

Sizes: 7 / 10 / 14 / 22 / 29 / 45

Nominal voltage: AC 230 V 50/60 Hz
alternative AC 115 V 50/60 Hz

The designated product is in conformity with the European EMC-Directive

89/336/EEC
including amendments

Council Directive of 03 May 1989 on the approximation of the laws of the Member States relating to electromagnetic compatibility.

Full compliance with the standards listed below proves the conformity of the designated product with the essential protection requirements of the above-mentioned EC Directive:

DIN EN 61 326 (VDE 0843 part 20): 1998-01	EN 61 326: 1997
DIN EN 61 326/A1 (VDE 0843 part 20/A1): 1999-05	EN 61 326: 1997/A1 : 1998
RFI suppression: Class B	
DIN EN 61 000-3-11 (VDE 0838 part 11): 2001-04	EN 61 000-3-11: 2000

The designated product is in conformity with the European Low Voltage Directive

73/23/EEC
including amendments

Council Directive on the approximation of the laws of the Member States relating to Electrical equipment for use within certain voltage limits.

Full compliance with the standards listed below proves the conformity of the designated product with the essential protection requirements of the above-mentioned EC Directive:

DIN EN 61 010-1 (VDE 0411 part 1): 1994-03	EN 61 010-1: 1993
DIN EN 61 010-2-010 (VDE 0411 part 2-010): 1995-03	EN 61 010-2-010: 1994

Schwabach, 30.06.06





(Legally binding signature of the issuer)

This declaration certifies compliance with the above mentioned directives but does not include a property assurance. The safety note given in the product documentation which are part of the supply, must be observed.

Standard units are safety-approved and bear the test marks:



 	<p>This product is subject to the Directive 2002/96/EC by the European Parliament and the EU Council of Ministers which concerns Waste Electrical and Electronic Equipment (WEEE). This product has been put on the market after 13 August 2005 in countries which have already incorporated this Directive into National Law. It should not be disposed off as part of domestic refuse. For disposal please contact your dealer or the manufacturer. Products which are infected, infectious or contaminated with health-endangering substances are excluded from return. Please note also all further regulations in this context.</p>
--	--

16 Address and customer service

MEMMERT GmbH+Co.KG
PO Box 17 20
91107 Schwabach
Germany
Phone: 00 49 9122 / 925-0
Fax: 00 49 9122 /14585
E-mail: sales@memmert.com
Internet: www.memmert.com



Customer service:
Phone: 00 49 9122 / 925-143
or 00 49 9122 / 925-126
E-mail: service@memmert.com

In case of queries always specify model and serial number (on the rating label)

© by MEMMERT GmbH+Co.KG

17 Index

A

address 25
alarm symbol 19, 20
ambient conditions 5
ambient temperature 23
autodiagnostic system 6

B

bath construction 10
boiling mode 5
boiling mode, activate 12
brief technical description 6

C

calibration difference 16
calibration of the temperature 16
calibration temperature 16
CE conformity of declaration 24
check list for fault rectification 23
chemical compatibility 6
circulating pump 14
cleaning 22
controls 10
cooling system 22
cover, flat 21
cover, gable 21, 22
customer service 25

D

deionised water 8
delayed switch-on 12
DIN 12880 19, 20
disposal 25
draining - oilbaths 9
draining - waterbaths 8
drain hose 21, 22
drain valve 8, 9

E

electrical equipment 6
electromagnetic compatibility 6
evaporation loss 21

F

fault rectification 23
filling - oilbaths 9
filling - waterbaths 8
flash point of the oil 9

G

glossary 23

H

heating, large-area 10
hinge bolts 22
hold time of the setpoint temperature 13

I

indication 10
initial start-up 8
installation 7
installation - oilbaths 9
installation - waterbaths 8

L

level control system 8, 21
level monitor 15
limeresidues 22
liquid level - oilbaths 9
liquid level - waterbaths 8
low-level protection 19

M

maintenance 22
Mat.Ref. 1.4301 6
material quality 6
monitor relay 20
monitor temperature, selection 15
monitor unit 19

N

nominal temperature 5, 23

P

parameter settings 11
polluted fluids 8, 9
programme sequence monitoring 18
programming example 17
Protection Class 1 19
Protection Class 2 20
Protection Class 3.1 20
Pt100 temperature sensor 6

R

rust deposits 22

S

safety notes 4
setpoint-dependent waiting time 13
setpoint dependent operation 23
setpoint temperature 23
setpoint temperature, selection 12
Setup menu 15
standard equipment 7
supply failure 23
switching on the bath 11

T

TB 19
technical data 5
temperature diviation 16
temperature fluctuation 6
temperature limiter (TB) 19
temperature limiter (TWB) 20
temperature measurement 6
temperature monitor 15, 19
temperature monitor, selection 17
temperature monitor (TWW) 20
temperature setpoint 23
temperature setpoint, selection 12
thermostating liquid 6, 21
thermostating liquid - oilbaths 9
thermostating liquid - waterbaths 8
transport 4
TWB 20
TWW 20

U

uniform temperature distribution 10

W

water circulation 10
working temperature range 5

27.06.2006
Water-/Oilbath EXCELLENT englisch

D10305