



memmert
Experts in Thermostatics

UN UF
IN IF
SN SF



OPERATING INSTRUCTIONS

UNIVERSAL OVEN U
INCUBATOR I
STERILISER S

100% ATMOSAFE. MADE IN GERMANY.

www.memmert.com | www.atmosafe.net

Manufacturer and customer service

MEMMERT GmbH + Co. KG
Postfach 17 20
91107 Schwabach, Germany

Äußere Rittersbacherstr. 38
91126 Schwabach
Germany

Phone: +49 (0)9122 925-0
Fax: +49 (0)9122 14585
E-mail: sales@memmert.com
Internet: www.memmert.com

Customer service:

Service hotline: +49 (0)9171 9792 911
Service fax: +49 (0)9171 9792 979
E-mail: service@memmert.com

When contacting customer service, always quote the product serial number on the nameplate (see page 12).

Shipping address for repairs:

Memmert GmbH + Co. KG
Kundenservice
Willi-Memmert-Str. 90-96
DE-91186 Büchenbach
Germany

Please contact our customer service before sending appliances for repair or before returning equipment, otherwise, we have to refuse acceptance of the shipment.

© 2012 MEMMERT GmbH + Co. KG

Date 09/2012

We reserve the right to make changes

About this manual

Purpose and target group

This manual describes the setup, function, transport, operation and maintenance of universal ovens UN/UF, sterilisers SN/SF and incubators IN/IF. It is intended for use by trained personnel of the owner who have the task of operating and/or maintaining the respective appliance.

If you are asked to work on the appliance, read this manual carefully before starting. Familiarise yourself with the safety regulations. Only perform work that is described in this manual. If there is something you do not understand, or certain information is missing, ask your superior or contact the manufacturer. Do not do anything without authorisation.

Versions

The appliances are available in different configurations and sizes. If specific equipment features or functions are available only for certain configurations, this is indicated at the relevant points in this manual.

Due to individual configurations and sizes, illustrations in this manual may be slightly different from the actual appearance. Function and operation are identical.

Other documents that have to be observed:

- ▶ For operation of the appliance with MEMMERT AtmoCONTROL, observe the separate software manual
- ▶ For service and repair (see page 41), please refer to the separate service manual

Storage and forwarding

This instruction manual belongs with the appliance and should always be stored where persons working on the appliance have access to it. It is the responsibility of the owner to ensure that persons who are working or will work on the appliance are informed as to the whereabouts of this instruction manual. We recommend that it is always stored in a protected location close to the appliance. Make sure that the instruction manual is not damaged by heat or humidity. If the appliance is sold on or transported and then set up again at a different location, the operating instructions must go with it.

Contents

1. Safety regulations	6
1.1 Terms and signs used.....	6
1.1.1 Terms used	6
1.1.2 Signs used.....	6
1.2 Product safety and dangers	7
1.3 Requirements of the operating personnel	7
1.4 Responsibility of the owner.....	8
1.5 Intended use.....	8
1.6 Changes and alterations.....	9
1.7 Behaviour in case of malfunctions and irregularities.....	9
1.8 Switching off the appliance in an emergency	9
2. Construction and description	10
2.1 Construction	10
2.2 Function.....	11
2.3 Material.....	11
2.4 Electrical equipment.....	11
2.5 Connections and interfaces.....	12
2.5.1 Electrical connection.....	12
2.5.2 Communication interface.....	12
2.6 Designation (nameplate).....	12
2.7 Technical data	13
2.8 Ambient conditions.....	14
2.9 Scope of delivery	15
2.10 Optional accessories.....	15
3. Delivery, transport and setting up	16
3.1 Safety regulations.....	16
3.2 Delivery	16
3.3 Transport.....	16
3.4 Unpacking	16
3.4.1 Checking for completeness and transport damage.....	16
3.4.2 Disposing of packaging material.....	16
3.5 Storage after delivery	17
3.6 Setting up.....	17
3.6.1 Installation options.....	18
4. Putting into operation	19
4.1 Connecting the appliance	19
4.2 Switching on.....	19
5. Operation and control	20
5.1 Operating personnel.....	20
5.2 Opening the door.....	20
5.3 Loading the appliance.....	21
5.4 Operating the appliance.....	21
5.4.1 ControlCOCKPIT.....	21
5.4.2 Basic operation	23
5.4.3 Operating modes.....	23
5.4.4 Manual mode	24
5.4.5 Timer operation	24

5.5	Temperature monitoring	26
5.5.1	Electronic temperature monitoring	26
5.5.2	Mechanical temperature monitoring: Temperature limiter (TB).....	26
5.5.3	Function.....	27
5.6	Ending operation.....	27
6.	Malfunctions, warning and error messages	28
6.1	Warning messages of the temperature monitoring function	28
6.2	Malfunctions, operating problems and appliance errors	29
6.3	Power failure.....	29
7.	Menu mode	30
7.1	Overview.....	30
7.2	Basic operation in menu mode using the example of language selection.....	31
7.3	Setup.....	32
7.3.1	IP address.....	32
7.3.2	Unit33	
7.3.3	Temperature monitoring (Alarm Temp).....	34
7.3.4	Timer Mode	35
7.4	Date and time.....	36
7.5	Adjustment.....	38
8.	Sterilisers SF/SN	40
8.1	Intended use.....	40
8.2	Note in accordance with Medical Devices Directive	40
8.3	Guidelines for sterilisation.....	40
9.	Maintenance and service	41
9.1	Cleaning.....	41
9.1.1	Working chamber and metal surfaces	41
9.1.2	Plastic parts.....	41
9.1.3	Glass surfaces	41
9.2	Regular maintenance.....	41
9.3	Repairs and service	41
10.	Storage and disposal	42
10.1	Storage	42
10.2	Disposal	42
	Index	43

1. Safety regulations

1.1 Terms and signs used

In this manual, certain common terms and signs are used to warn you of danger or to give you hints that are important in avoiding injury or damage. Observe and follow these hints and regulations to avoid accidents and damage. These terms and signs are explained below.

1.1.1 Terms used

"Warning" is used whenever you or somebody else could be injured if you do not observe the accompanying safety regulation.

"Caution" is used for information that is important for avoiding damage.

1.1.2 Signs used

Warning signs (warning of a danger)



Danger of electrocution



Danger of explosion



Dangerous gases / vapours



Danger of burns



Danger of toppling over

Prohibition signs (forbidding an action)



Do not lift



Do not tilt



Do not enter

Regulation signs (stipulating an action)

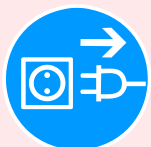

Disconnect the mains plug



Wear gloves



Wear safety boots



Observe information in separate manual

Other icons



Important or useful additional information

1.2 Product safety and dangers

The appliances described in this manual are technically sophisticated, manufactured using high-quality materials and subject to many hours of testing in the factory. They contain the latest technology and comply with recognised technical safety regulations. However, there are still risks involved, even when the appliances are used as intended. These are described below.

**Warning!**

After removing covers, live parts may be exposed. You may receive an electric shock if you touch these parts. Disconnect the mains plug before removing any covers. Only electrical technicians may work on the electrical equipment of the appliances.

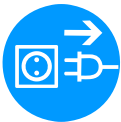
**Warning!**

When loading the appliance with an unsuitable load, poisonous or explosive vapours or gases may be produced. This could cause the appliance to explode, and persons could be severely injured or poisoned. The appliance may only be loaded with materials/test objects which do not form any toxic or explosive vapours when heated up (see also "Intended use" on page 8).

**Warning!**

Depending on operation, the surfaces in the working chamber and the chamber load may still be very hot after the appliance is switched off. Touching these surfaces can cause burns. Wear heat-resistant protective gloves or wait until the appliance cools down. To do so, pull the handle bar until the door springs open into its ventilating position (see page 20).

**Warning!**

In case of appliances of a certain size, you can get accidentally locked in, which is life-threatening. Do not climb into the appliance!

1.3 Requirements of the operating personnel

The appliance may only be operated and maintained by persons who are of legal age and have been instructed accordingly. Personnel who are to be trained, instructed or who are undergoing general training may only work with the appliance under the continuous supervision of an experienced person.

Repairs may only be performed by qualified electricians. The regulations in the separate service manual must be observed.

1.4 Responsibility of the owner

The owner of the appliance

- ▶ is responsible for the flawless condition of the appliance and for its proper operation in accordance with its intended use (see page 8);
- ▶ is responsible for ensuring that persons who are to operate or service the appliance are qualified to do this, have been instructed accordingly and are familiar with the operating instructions at hand;
- ▶ must know about the applicable guidelines, requirements and operational safety regulations, and train staff accordingly;
- ▶ is responsible for ensuring that unauthorised persons have no access to the appliance;
- ▶ is responsible for ensuring that the maintenance plan is adhered to and that maintenance work is carried out properly (see page 41);
- ▶ has to ensure that the appliance and its surroundings are kept clean and tidy, for example through corresponding instructions and inspections;
- ▶ is responsible for ensuring that personal protective clothing is worn by operating personnel, e.g. work clothes, safety shoes and protective gloves.

1.5 Intended use

This appliance is exclusively intended for heating up non-explosive substances and objects. Any other use is improper, and may result in hazards and damage.

The appliance is not explosion-proof (does not comply with the German workplace health & safety regulation VBG 24). The appliance may only be loaded with materials and substances which cannot form any toxic or explosive vapours at the set temperature and which cannot explode, burst or ignite.

The appliance may not be used for drying, vaporising and branding paints or similar materials the solvents of which could form an explosive mixture when combined with air. If there is any doubt as to the composition of materials, they must not be loaded into the appliance. Potentially explosive gas-air mixtures must not form, neither in the working chamber nor in the direct vicinity of the appliance.

Intended use as a medical device

For appliances subject to the 93/42/EEC guideline (Council Directive on the approximation of the laws of the Member States relating to medical devices), the intended use is defined as follows:

- ▶ For appliances of the UF series: The appliance serves for heating non-sterile cloths and covers.
- ▶ For appliances of the IF series: The appliance serves for heating non-sterile cloths and covers, as well as for temperature control of rinsing and infusion solutions.
- ▶ For appliances of the IN series: The appliance serves for temperature control of rinsing and infusion solutions.
- ▶ For appliances of the SF series: The appliance serves for sterilising medical material through dry heated air at atmospheric pressure (also see page 40).

1.6 Changes and alterations

No unauthorised changes or alterations may be made to the appliance. No parts may be added or inserted which have not been approved by the manufacturer.

Unauthorised modifications or changes result in the CE declaration of conformity losing its validity and the appliance must no longer be operated.

The manufacturer is not liable for any damage, danger or injuries that result from unauthorised changes or alterations, or from non-observance of the regulations in this manual.

1.7 Behaviour in case of malfunctions and irregularities

The appliance may only be used in a flawless condition. If you as the operator notice irregularities, malfunctions or damage, immediately take the appliance out of service and inform your superior.

i You can find information on correcting malfunctions from page 28.

1.8 Switching off the appliance in an emergency

Push the On/Off switch on the control panel (Fig. 1). This disconnects the appliance from the power supply at all poles.



Warning!
Depending on the operation performed, the surfaces in the working chamber and the chamber load may still be very hot after the appliance is switched off. Touching these surfaces can cause burns. Wear heat-resistant protective gloves or wait until the appliance cools down. To do so, pull the handle bar until the door springs open into its ventilating position (see page 20).

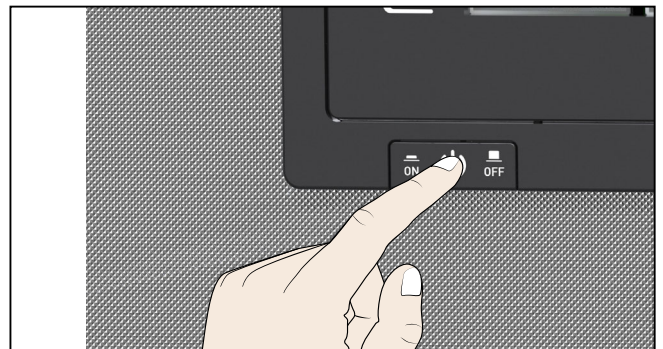

Fig. 1
Switch off the appliance by pressing the On/Off switch

2. Construction and description

2.1 Construction



Fig. 2 Construction

- 1 ControlCOCKPIT with capacitive function keys (see page 22)
- 2 On/Off switch (see page 19)
- 3 Working chamber fan (for UF/IF/SF appliances only)

- 4 Steel grid
- 5 Working chamber
- 6 Nameplate (covered, see page 12)
- 7 Door handle (see page 20)
- 8 Turn control with confirmation key

2.2 Function

Appliances of the UN, SN and IN type series feature natural circulation (convection). For the UF, SF and IF type series, air is circulated by a fan at the working chamber rear panel (Fig. 3, No. 1). It increases the air flow and provides stronger horizontal forced air circulation than natural convection.

In both the convection and fan ventilated appliances, supply air (2) is preheated in a pre-heating chamber (3). Through the ventilation slits in the side panel of the working chamber, the preheated air is introduced into the interior of the chamber. The supply and exhaust air (5) volume (air change) is controlled by the air flap (4) on the rear panel of the appliance.

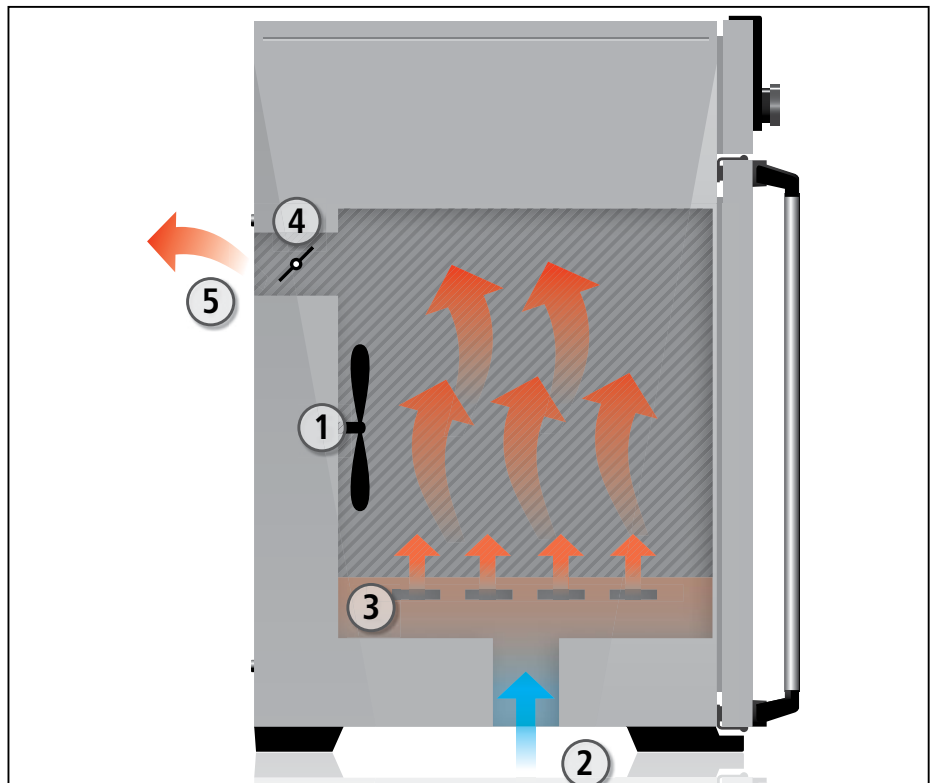

Fig. 3 Function
 1 Fan
 2 Fresh air
 3 Pre-heating chamber
 4 Air flap
 5 Exhaust air

2.3 Material

For the outer housing, MEMMERT deploys stainless steel (Mat.No. 1.4016 – ASTM 430) and for the interior, stainless steel (Mat.No. 1.4301 – ASTM 304) is used, which stands out through its high stability, optimal hygienic properties and corrosion-resistance towards many (but not all!) chemical compounds (caution for example with chlorine compounds).

The chamber load for the appliance must be carefully checked for chemical compatibility with the materials mentioned. A material resistance table can be requested from the manufacturer.

2.4 Electrical equipment

- ▶ Operating voltage and current consumption: See nameplate
- ▶ Protection class 1, i.e. operating insulation with PE conductor in accordance with EN 61010
- ▶ Protection type IP 20 acc. to EN 60 529
- ▶ Interference suppression acc. to EN 55011 class B
- ▶ Appliance fuse: Fusible link 250 V/15 A quick-blow
- ▶ The temperature controller is protected with a miniature fuse 100 mA (200 mA at 115 V)

2.5 Connections and interfaces

2.5.1 Electrical connection

This appliance is intended for operation on an electrical power system with a system impedance Z_{max} of a maximum of 0.292 ohm at the point of transfer (service line). The operator must ensure that the appliance is operated only on an electrical power system that meets these requirements. If necessary, you can ask your local energy supply company what the system impedance is.

Observe the country-specific regulations when connecting (e.g. in Germany DIN VDE 0100 with residual current circuit breaker).

2.5.2 Communication interface

Via Ethernet interface, the appliance can be connected to a network to read out protocol logs with AtmoCONTROL, the optional appliance software. The Ethernet interface is located on the rear of the appliance (Fig. 4).

For identification purposes, each appliance connected must have its own unique IP address. Setting the IP address is described on page 32.

With an optional USB to Ethernet converter, the appliance can be directly connected to a computer / laptop (see "Optional accessories" on page 15).

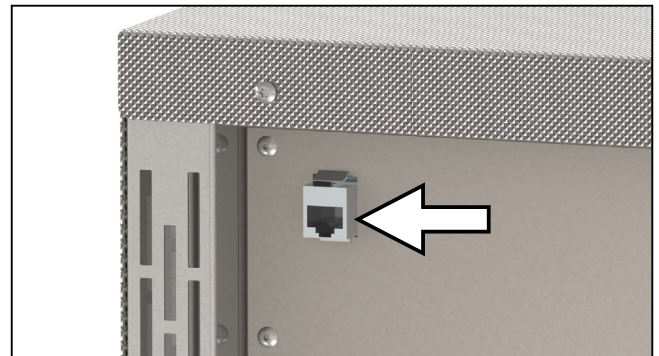

Fig. 4 Ethernet interface

2.6 Designation (nameplate)

The nameplate (Fig. 5) provides information about the appliance model, manufacturer and technical data. It is attached to the front of the appliance, on the right side under the door (see page 10).

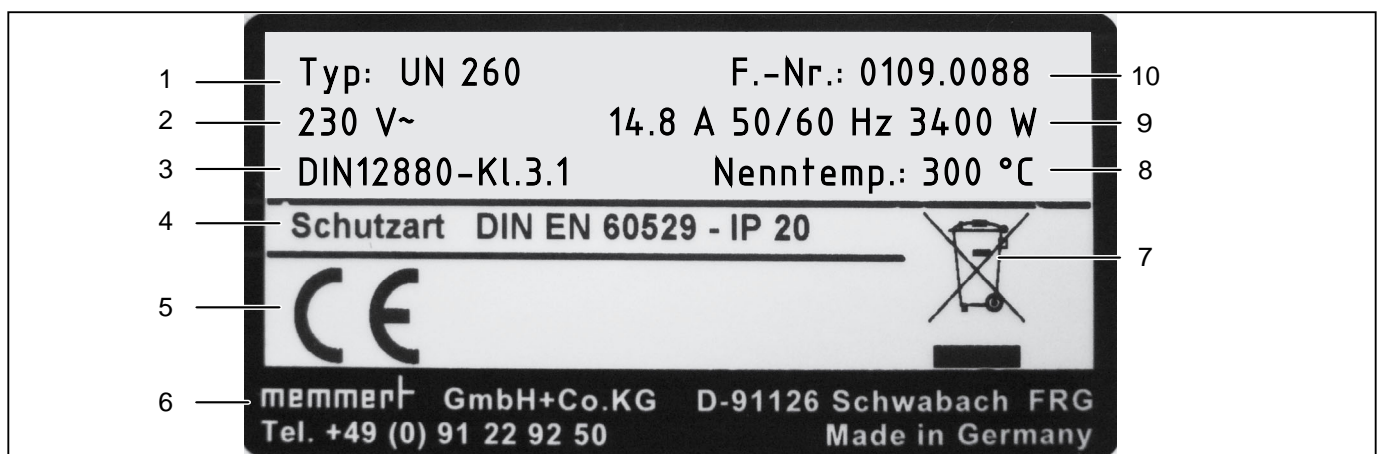

Fig. 5 Nameplate (example)

- | | | | |
|---|-------------------|----|----------------------------|
| 1 | Type designation | 6 | Address of manufacturer |
| 2 | Operating voltage | 7 | Disposal note |
| 3 | Applied standard | 8 | Temperature range |
| 4 | Protection type | 9 | Connection / power ratings |
| 5 | CE conformity | 10 | Appliance number |

2.7 Technical data

Appliance size	30	55	75	110	160	260	450	750
Appliance width D ¹ [mm]	585	585	585	745	745	824	1224	1224
Appliance height E ¹ [mm]	707	787	947	867	1107	1186	1247	1726
Appliance depth G ¹ (footprint) [mm]	434	514	514	584	584	684	784	784
Depth of door lock [mm]	56							
Appliance depth F ¹ (including door handle) [mm]	490	570	570	640	640	740	840	840
Working chamber width A ¹ [mm]	400	400	400	560	560	640	1040	1040
Working chamber height B ¹ [mm]	320	400	560	480	720	800	720	1200
Working chamber depth C ¹ [mm]	250	330	330	400	400	500	600	600
Chamber volume [litres]	32	53	74	108	161	256	449	749
Weight [kg]	37	45	51	68	72	91	125	163
Power [W]	IN/IF	800	1000	1250	1400	1600	1700	1700
	UN/UF/SN/SF	1600	2000	2500	2800	3200	3400	–
Current consumption [A]	230 V	1100	1400	1700	2000	2200	2200	5800 ²
	115 V	–	–	–	–	–	–	7000
	400 V	–	–	–	–	–	–	–
	230 V	3.5	4.3	5.4	6.1	7.0	7.4	7.4
max. number of sliding shelves	115 V	7.0	8.7	10.9	12.2	13.9	14.8	14.8
	230 V	7.0	8.7	10.9	12.2	13.9	14.8	–
	115 V	9.6	12.2	14.8	17.4	19.1	19.1	3 x 8.4 ²
max. load per sliding shelves [kg]	400 V	–	–	–	–	–	–	3 x 10.2
	230 V	3	4	6	5	8	9	14
max. load per appliance [kg]	IN/IF	30						
	UN/UF	60	80	120	175	210	300	300
	SN/SF	–	–	–	–	–	–	–
Setting temperature range	IN/IF	+20 to +80 °C						
	UN/UF	+20 to +300 °C						
	SN/SF	+20 to +250 °C						
Adjustment precision	IN/IF	0.1 K						
	UN/UF/SN/SF	up to 100 °C: 0.1 K, above 100 °C: 0.5 K						

¹ See Fig. 6 on page 14.

² 3 x 230 V without zero

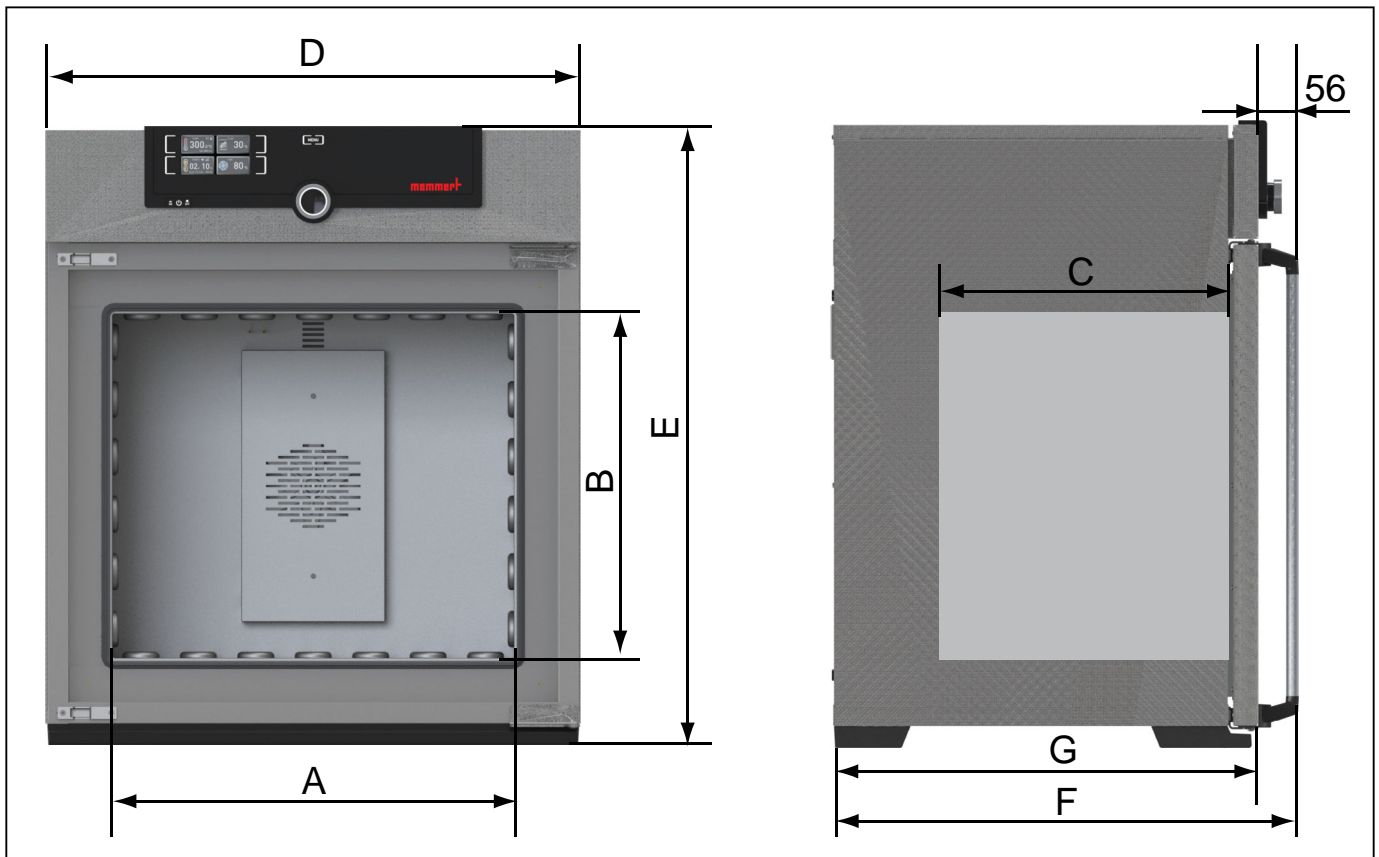

Fig. 6 Dimensions (see table on page 13)

2.8 Ambient conditions

- ▶ The appliance may only be used in enclosed rooms and under the following ambient conditions:

Ambient temperature	+5 °C to +40 °C
Humidity rh	max. 80 %, non-condensing
Overvoltage category	II
Pollution degree	2
Altitude of installation	max. 2,000 m above sea level

- ▶ The appliance may not be used in areas where there is a risk of explosion. The ambient air must not contain any explosive dusts, gases, vapours or gas-air mixtures. The appliance is not explosion-proof.
- ▶ Heavy dust production or aggressive vapours in the vicinity of the appliance could lead to sedimentation in the interior and, as a consequence, could result in short circuits or damage to electrical parts. For this reason, sufficient measures to prevent large clouds of dust or aggressive vapours from developing should be taken.

2.9 Scope of delivery

- ▶ Power cable
- ▶ One or two sliding steel grids (load capacity 30 kg each)
- ▶ The operating instructions at hand
- ▶ Calibration certificate
- ▶ For certain appliance configurations and sizes, the scope of delivery also includes separately packaged fastening material for wall mounting to protect the appliance from tipping over (see page 17)

2.10 Optional accessories

- ▶ AtmoCONTROL software for reading out and processing of protocol log files
- ▶ USB to Ethernet converter (Fig. 7). Makes it possible to connect the appliance's network interface (see page 12) to the USB port of a computer / laptop.
- ▶ Reinforced, sliding steel grids with a load capacity of 60 kg each (for appliance size 110 and larger)

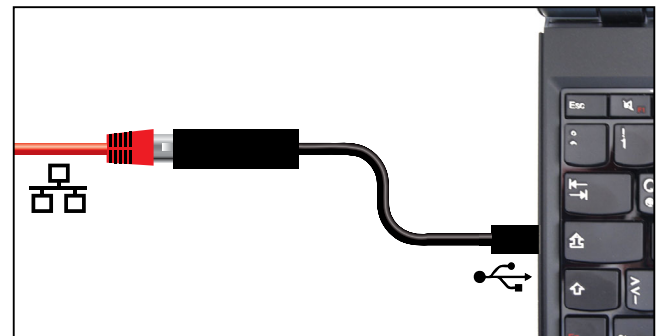

Fig. 7 Converter USB to Ethernet

3. Delivery, transport and setting up

3.1 Safety regulations



Warning!

You may get your hands or feet squashed when transporting and installing the appliance. Wear protective gloves and safety boots.



Warning!

Because of the heavy weight of the appliance, you could injure yourself if you try to lift it. To carry appliances of the sizes 30 and 55, at least two persons, for appliances of the sizes 75 and 110, four people are needed. Appliances larger than that may not be carried but must be transported with a manual pallet jack or forklift truck.

30	55	75	110	160	260	450	750



Warning!

The appliance could fall over and seriously injure you. Never tilt the appliance and transport it in upright position only.

3.2 Delivery

The appliance is packed in cardboard and is delivered on a wooden palette.

3.3 Transport

The appliance can be transported in three ways:

- ▶ With a forklift truck; move the forks of the truck entirely under the pallet
- ▶ On a manual pallet jack
- ▶ On its own castors, in case of the corresponding configuration, for which the catch on the (front) castors must be released

3.4 Unpacking



To avoid damage, do not unpack the appliance until you reach the installation site.

Remove the cardboard packaging by pulling it upwards or carefully cutting along an edge.

3.4.1 Checking for completeness and transport damage

- ▶ Check the delivery note to ensure that the delivery is complete.
- ▶ Check the appliance for damage.

If you notice deviations from the delivery note, damage or irregularities, do not put the appliance into operation but inform the haulage company and the manufacturer.

3.4.2 Disposing of packaging material

Dispose of the packaging material (cardboard, wood, foil) in accordance with the applicable disposal regulations for the respective material in your country.

3.5 Storage after delivery

If the appliance is first to be stored after delivery: Read the storage conditions from page 42.

3.6 Setting up



Warning!

Due to their centre of gravity, appliances of certain sizes can fall over to the front and injure you or other people. Separately packaged fastening material is included in the scope of delivery of the appliances concerned. After setting up the appliance, use this fastening material for mounting the appliance's rear side to a wall. Observe the assembly instructions provided.

The installation site must be flat and horizontal and must be able to reliably bear the weight of the appliance (see "Technical data" on page 13). Do not place the appliance on a flammable surface.

Depending on the model (see nameplate), a 230 V, 115 V or 400 V power connection must be available at the installation site.

The distance between the wall and the rear of the appliance must be at least 15 cm. The clearance from the ceiling must not be less than 20 cm and the side clearance from walls or nearby appliances must not be less than 5 cm (Fig. 8). Sufficient air circulation in the vicinity of the appliance must be guaranteed at all times.

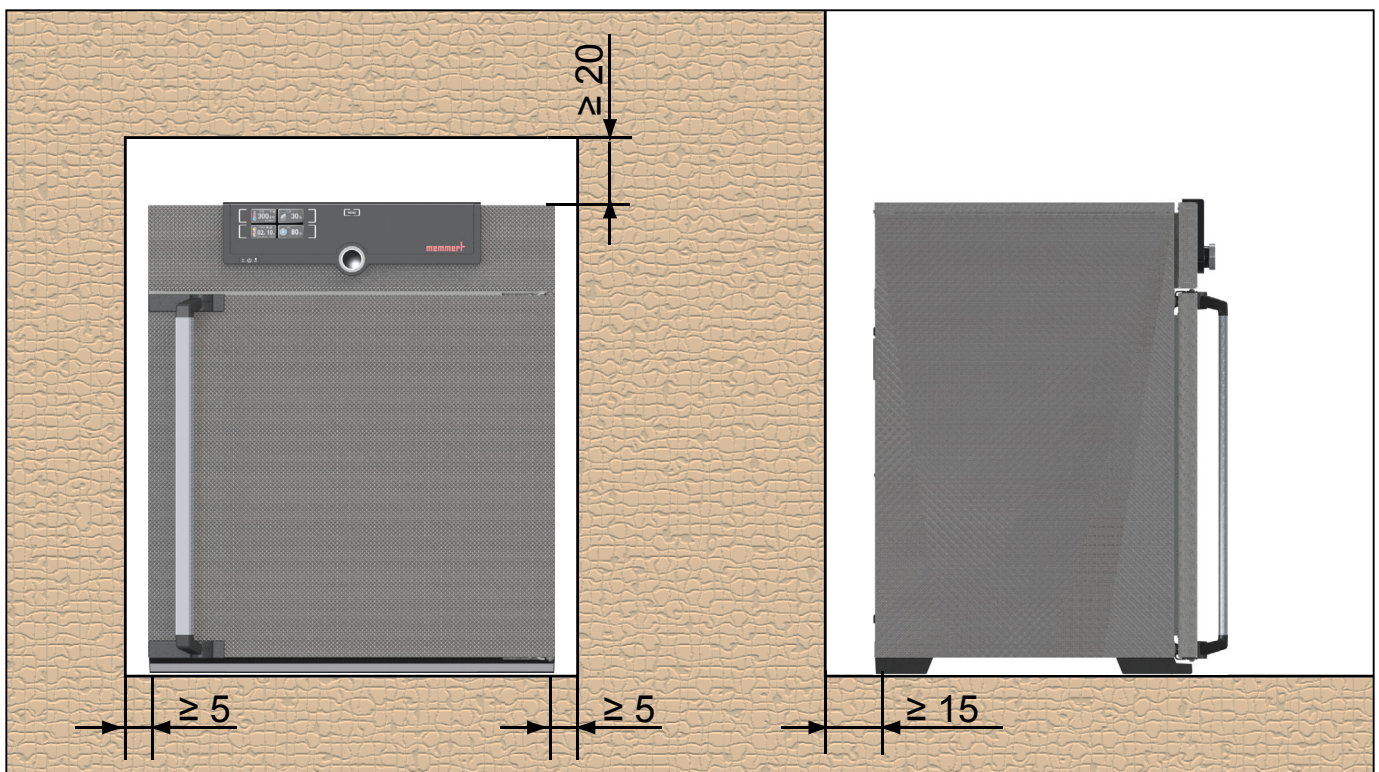

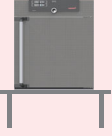







Fig. 8 Minimum clearance from walls and ceiling

3.6.1 Installation options

Setting up	Comments	Suitable for appliance size ...							
		30	55	75	110	160	260	450	750
Floor 		✓	✓	✓	✓	✓	✓	✓	✓
Table 	Check the load capacity first	✓	✓	✓	✓	✗	✗	✗	✗
Stacked 	two appliances maximum; mounting material (feet) provided	✓	✓	✓	✓	✗	✗	✗	✗
Wall mounting 	Separately packaged fastening material is included in the scope of delivery. Observe the assembly instructions provided.	✓	✓	✓	✓	✓	✗	✗	✗
Base 	with/without castors	✓	✓	✓	✓	✓	✓	✓	✗
Castor frame 		✓	✓	✓	✓	✓	✓	✗	✗
Height adjustable feet 		✓	✓	✓	✓	✓	✓	✓	✓

4. Putting into operation

● Caution:

i The first time the appliance is operated, it must not be left unattended until it has reached the steady state.

4.1 Connecting the appliance

● Caution:

i Observe the country-specific regulations when making connections (e.g. in Germany DIN VDE 0100 with residual current circuit breaker). Observe the connection and power ratings (see nameplate and "Technical data" on page 13).

Plug the provided power cable into the rear of the appliance and connect it to the power supply (Fig. 9).

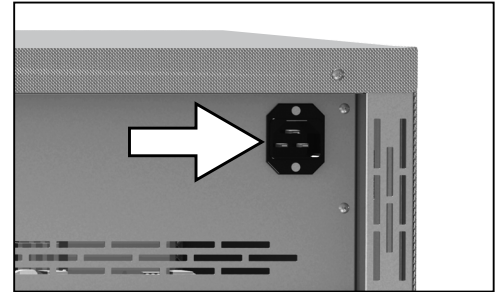

Fig. 9 Connect the power cable to the rear of the appliance

4.2 Switching on

Switch on the appliance by pressing the On/Off switch on the front of the appliance (Fig. 10).

i If the appliance has never been operated before, you will be prompted to set the operating language, date and time when you first switch it on. A description of how to do this is given from page 31. However, to get a basic overview of operating the appliance, you should read the following chapter first.

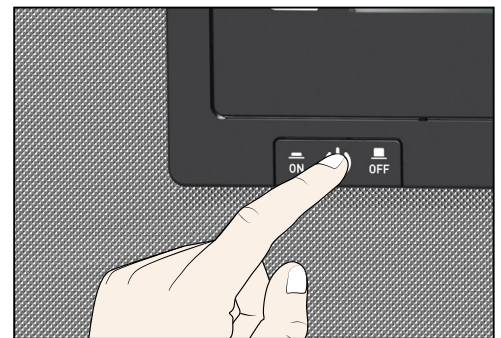

Fig. 10 Switch on appliance

5. Operation and control

Caution:

i When loading and operating sterilisers of the SN/SF type, make sure to observe the special notes provided in chapter "Sterilisers SF/SN" from page 40.

5.1 Operating personnel

The appliance may only be operated by persons who are of legal age and have been instructed accordingly. Personnel who are to be trained, instructed or who are undergoing general training may only work with the appliance under the continuous supervision of an experienced person.

5.2 Opening the door

- ▶ To open the door, pull the handle bar to the side (to the left or to the right, depending on the door variation, see Fig. 11, A). The door opens slightly, so that the heat can be vented with the door ajar in case of high temperature inside the chamber. The door can then be opened completely (B).
- ▶ To close the door, push the handle bar back (C).

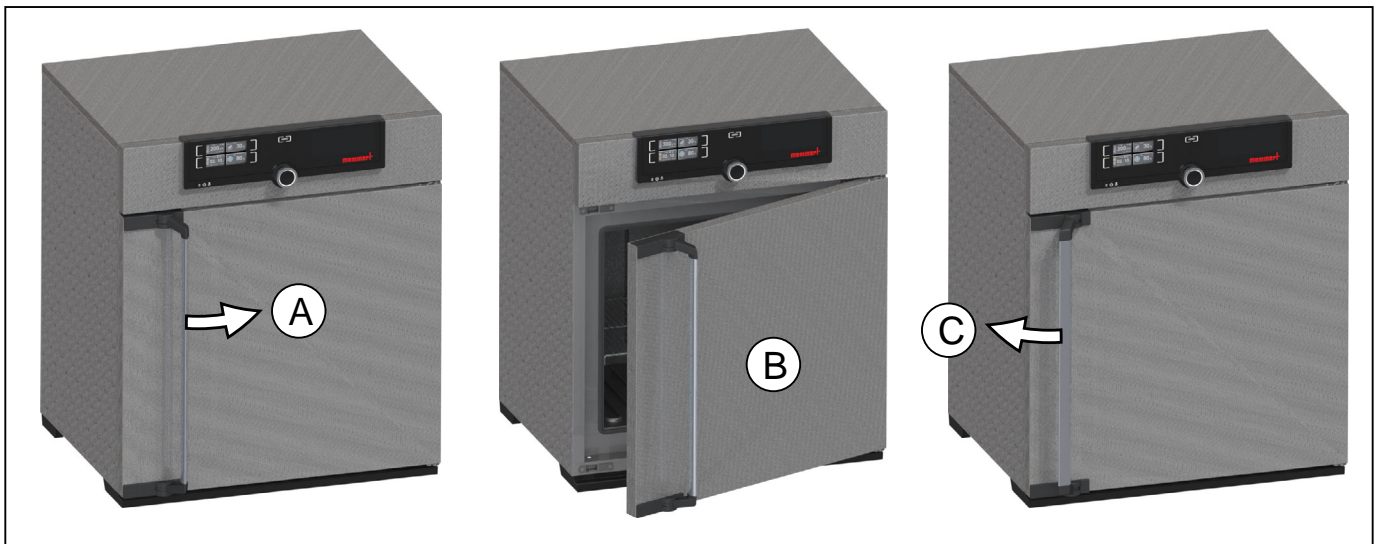

Fig. 11 Opening and closing the door



Warning!

In case of appliances of a certain size, you can get accidentally locked in, which is life-threatening. Do not climb into the appliance!

5.3 Loading the appliance



Warning!

When loading the appliance with an unsuitable load, poisonous or explosive vapours or gases may be produced. This could cause the appliance to explode, and persons could be severely injured or poisoned. The appliance may only be loaded with materials which do not form any toxic or explosive vapours when heated up and cannot ignite (see also "Intended use" on page 8). If there is any doubt as to the composition of materials, they must not be loaded into the appliance.



i Caution:

Check the chamber load for chemical compatibility with the materials of the appliance (see page 11).

Insert the sliding steel grids or sliding shelves. The maximum number of grids / shelves and the load capacity are specified in the technical data overview on page 13.

The chamber must not be loaded too tightly, so that proper air circulation in the working chamber is guaranteed. Do not place any chamber load on the floor, touching the side walls or right below the ceiling of the working chamber (Fig. 12, see also the "correct loading" sticker on the appliance).

In case of improper loading (chamber loaded too tightly), reaching the set temperature may take longer than normal.

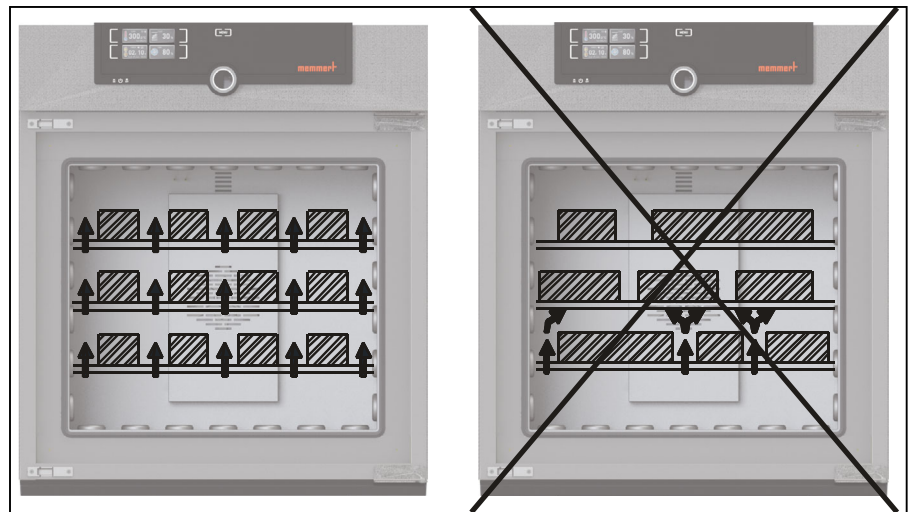

Fig. 12 Correct placement of the chamber load

5.4 Operating the appliance

5.4.1 ControlCOCKPIT

In manual operation, the desired parameters are entered at the ControlCOCKPIT on the front of the appliance (Fig. 13 and Fig. 14). You can also make basic settings here (menu). Additionally, warning messages are displayed, e.g. if the temperature is exceeded.

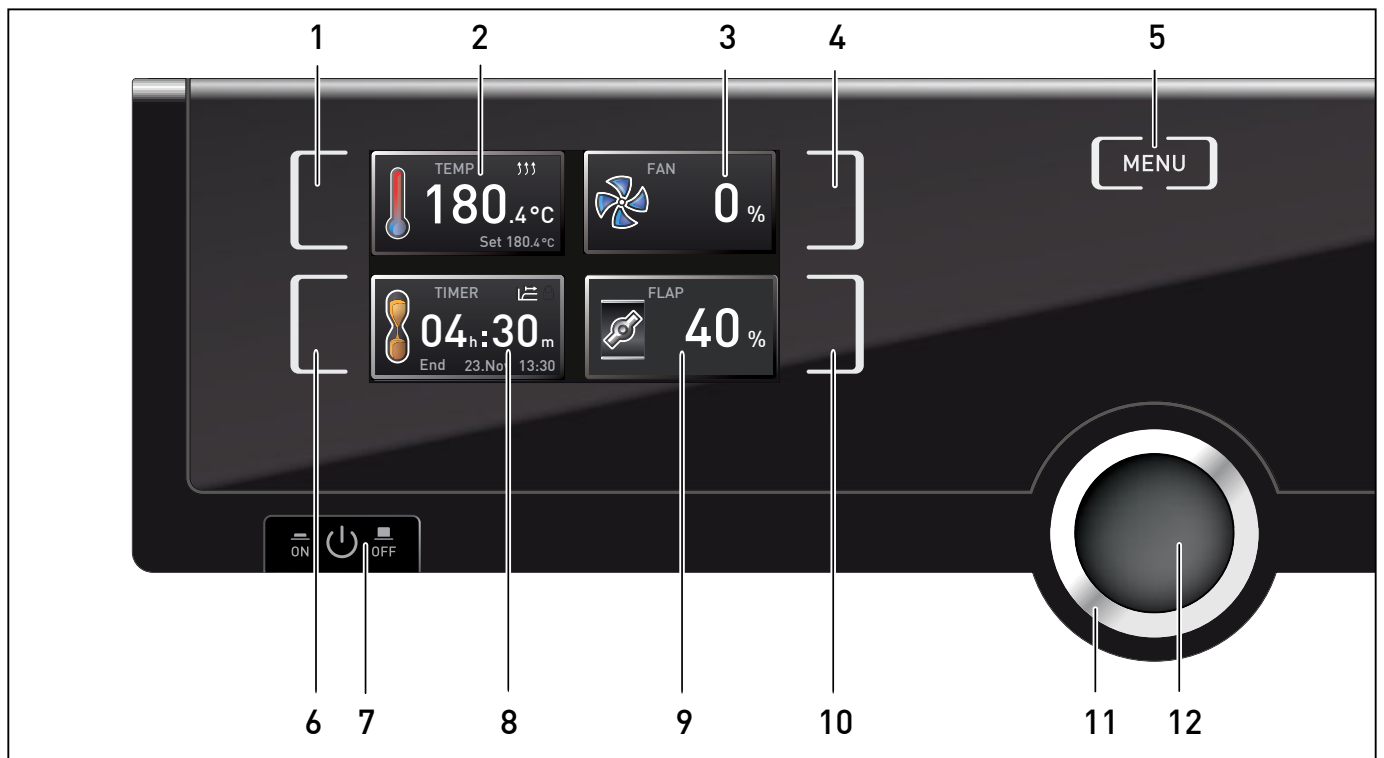

Fig. 13 ControlCOCKPIT for UF/IF/SF appliances in operating mode

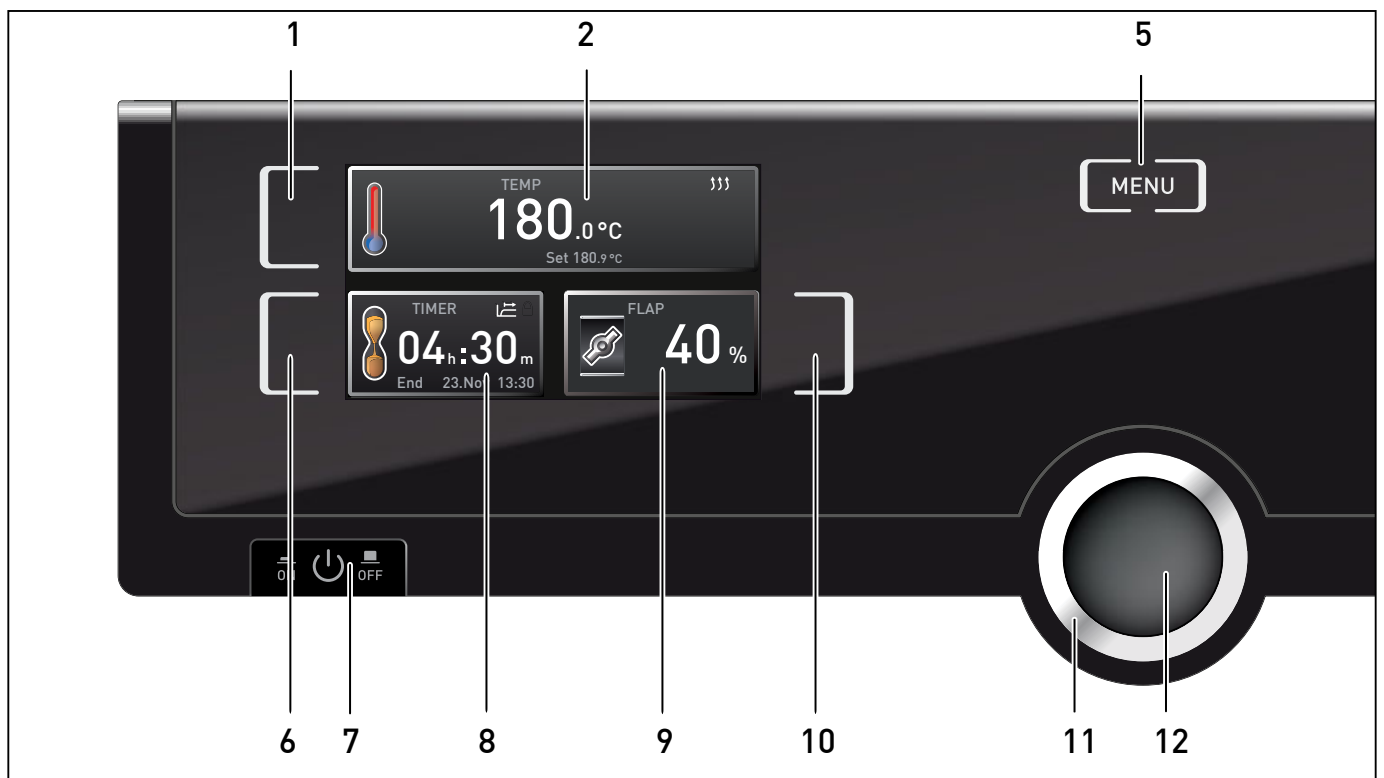

Fig. 14 ControlCOCKPIT for UN/IN/SN appliances in operating mode

- | | |
|--|--|
| 1 Activation key for temperature setpoint adjustment | 8 Timer display |
| 2 Setpoint and actual temperature display | 9 Air flap position display |
| 3 Fan speed display | 10 Activation key for air flap position adjustment |
| 4 Activation key for fan speed setting | 11 Turn control for setpoint adjustment |
| 5 Switch to menu mode (see page 30) | 12 Confirmation key (accepts setting made with the turn control) |
| 6 Activation key for timer setting | |
| 7 On/Off switch | |

5.4.2 Basic operation

In general, all settings are made according to the following pattern:

1. Activate the desired parameter (e.g. temperature). To do so, press the corresponding activation key on the left or right of the respective display. The activated display is lined in colour, the other displays are dimmed. The set value is highlighted in colour.
2. By turning the turn control to the left or right, adjust the set value (e.g. to 180.0 °C).
3. Save the set value by pressing the confirmation key. The display returns to normal and the appliance begins adjusting to the defined set value.

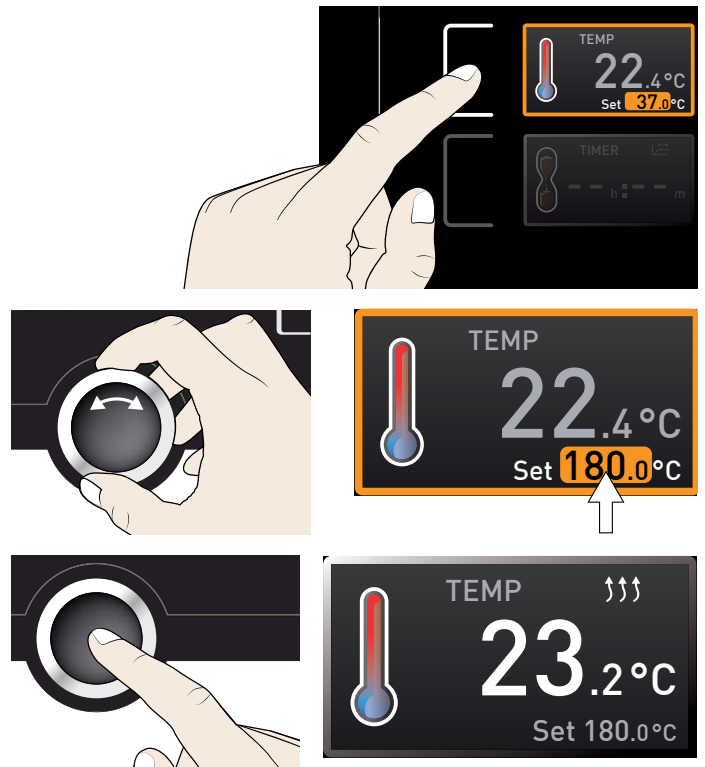

Additional parameters (air flap position etc.) can be set accordingly.

i If no new values are entered or confirmed for approx. 30 seconds, the appliance automatically returns to the main menu and restores the former values.

If you want to cancel the setting procedure, press the activation key on the left or right of the display that you want to exit. The appliance restores the former values. Only the settings that you have confirmed by pressing the confirmation key before cancelling the setting procedure are accepted.

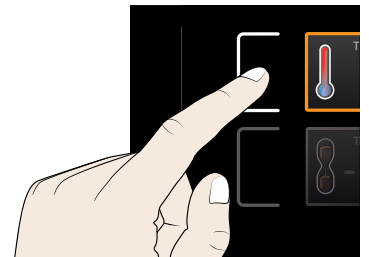

5.4.3 Operating modes

The appliance can be operated in two modes:

- ▶ **Manual mode:** The appliance runs in permanent operation at the values set on the ControlCOCKPIT. Operation in this mode is described in chapter 5.4.4.
- ▶ **Timer operation:** The appliance runs at the values set until the timer has elapsed. Operation in this mode is described in chapter 5.4.5.

5.4.4 Manual mode

In this operating mode, the appliance runs in permanent operation at the values set on the ControlCOCKPIT.

Adjustment options

As described in chapter 5.4.2, you can set the following parameters after pressing the corresponding activation key (in any sequence):

Temperature

Adjustment range: model dependent (see nameplate and technical date on page 13)

Heating operation is indicated by the ↑↑↑ symbol.

You can select °C or °F as the temperature unit displayed (see page 33).

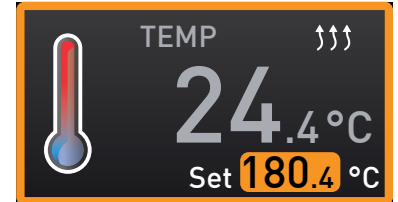

Air flap position

Adjustment range: 0 % (closed, recirculating operation) to 100 % (completely opened, fresh air operation) in steps of 10%

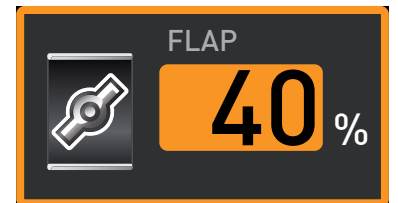

Fan speed

(only for UF/IF/SF appliances)

Adjustment range: 0 to 100 % in steps of 10%



5.4.5 Timer operation

In timer operation, you can adjust the time the appliance runs at the set value:

1. Press the activation key to the left of the timer display. The timer display is activated.

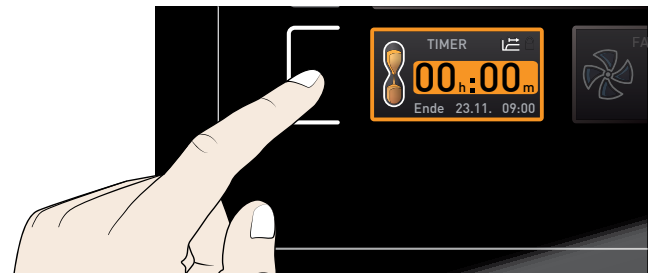

2. Turn the turn control until the desired duration is displayed – in this example 4 hours 30 minutes. The approximate end time is shown beneath, in a smaller font.



Up to a duration of 23 hours 59 minutes, the time is displayed in hh:mm (hours:minutes) format. For 24 hours and more, the format dd:hh (days:hours) is used. The maximum duration adjustable is 99 days 23 hours.

- Press the confirmation key. The display now shows the remaining time in a large font and the approximate end time in a smaller font beneath.

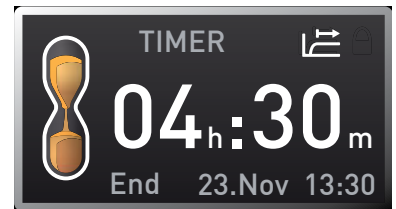
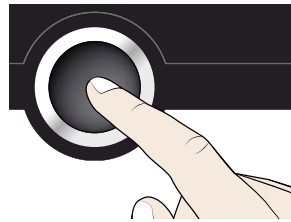

- Now, as described under 5.4.2, set the individual values for temperature, air flap position etc. which you want the appliance to operate at. For universal ovens UN/UF and incubators IN/IF, the set values can be changed while the timer elapses. The changes are effective immediately. For sterilisers SN/SF, parameters cannot be changed while the timer elapses.

i For universal ovens UN/UF and incubators IN/IF, you can choose if the timer should run setpoint-dependent or not in the **Setup** – this determines if the timer should not start until a tolerance band around the set temperature is reached or if it should start right after activation (see page 35). If the timer runs setpoint-dependent, this is indicated by the  symbol in the timer display.

When the timer has elapsed, the display shows 00:00. All functions (heating etc.) are switched off. If a fan had been active, it will keep on running for a short safety period.

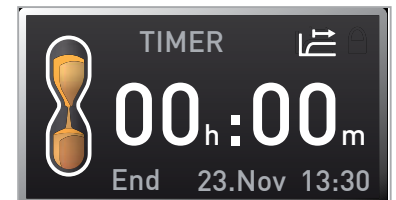

To deactivate the timer, open the timer display by pressing the activation key again and then turning the turn control to reduce the timer setting until --:-- is displayed. Confirm with the confirmation key.

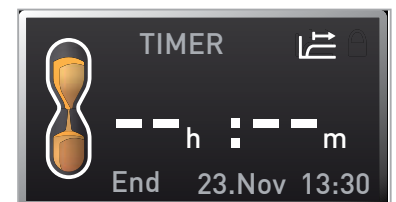

5.5 Temperature monitoring

The appliance is equipped with a double overtemperature protection (mechanical/electronic) in accordance with DIN 12 880. This serves to avoid damage to the chamber load and/or appliance in case of a malfunction:

- ▶ Electronic temperature monitoring
- ▶ mechanical temperature limiter (TB)

5.5.1 Electronic temperature monitoring

The monitoring temperature of the electronic temperature monitoring is measured via the Pt100 temperature sensor in the working chamber. The monitoring temperature (**Alarm Temp**) is set in menu mode in the **Setup** display (see page 34). The setting made applies to all operating modes.

If the manually set monitoring temperature is exceeded, temperature monitoring takes over temperature control and begins to regulate the monitoring temperature (Fig. 15).

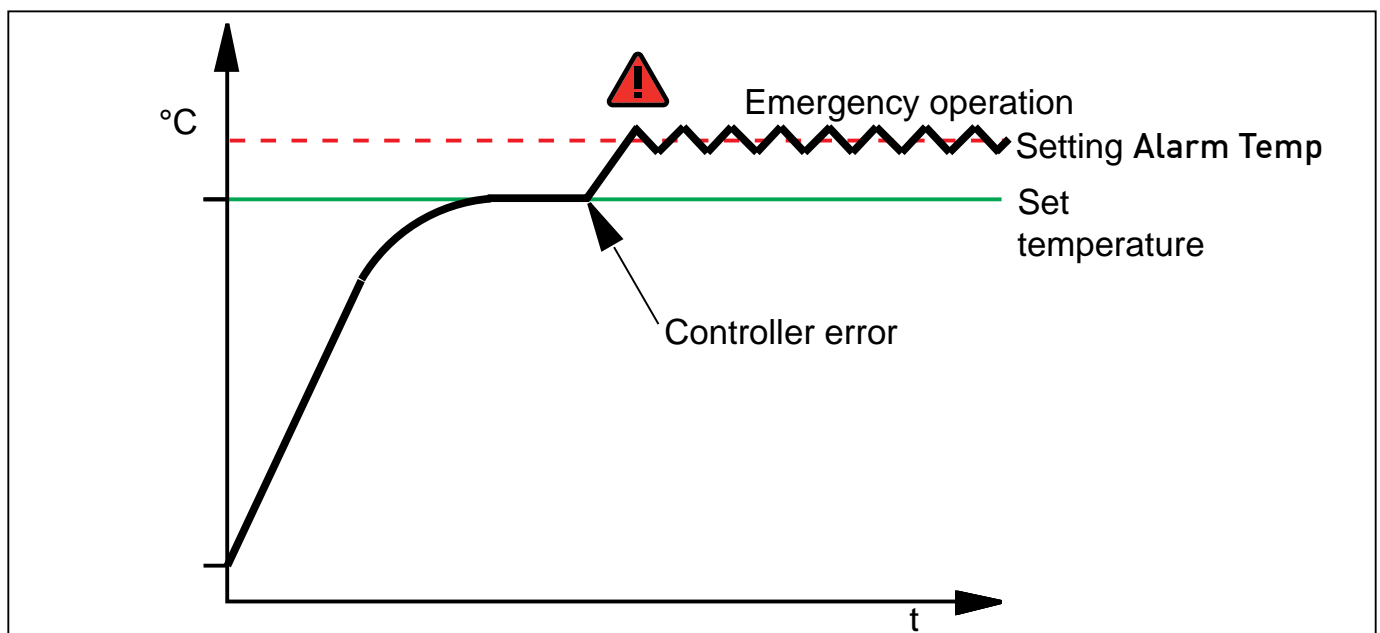



Fig. 15 Schematic diagram of how the electronic temperature monitoring system works

5.5.2 Mechanical temperature monitoring: Temperature limiter (TB)

The appliance is equipped with a mechanical temperature limiter (TB) of protection class 1 in accordance with DIN 12 880.

If the electronic monitoring unit should fail during operation and the factory-set maximum temperature is exceeded by approx. 20 °C, the temperature limiter, as the final protective measure, switches off the heating permanently.

5.5.3 Function

If temperature monitoring has been triggered, this is indicated by the temperature display: the actual temperature is highlighted in red and a warning symbol  is shown (Fig. 16). The type of temperature monitoring triggered is shown beneath the temperature. **max** for electronic and **TB** for mechanical temperature limiting. Additionally, the alarm is signalled by an intermittent acoustic signal. Information on what to do in this case are provided in the chapter Malfunctions, warning and error messages from page 28.

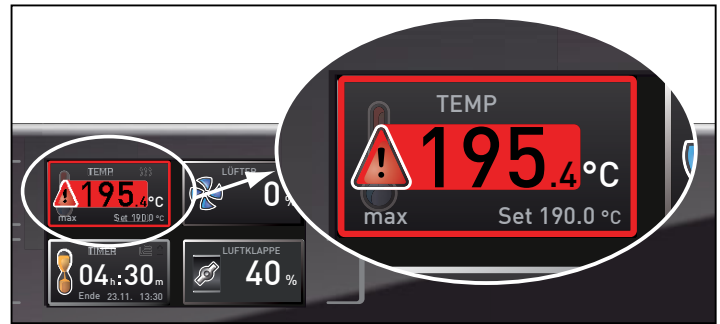

Fig. 16
Temperature monitoring triggered

5.6 Ending operation



Warning!

Depending on the operation performed, the surfaces in the working chamber and the chamber load may still be very hot after the appliance is switched off. Touching these surfaces can cause burns. Wear heat-resistant protective gloves or wait until the appliance cools down. To do so, pull the handle bar until the door springs open into its ventilating position (see page 20).



1. Switch off active appliance functions (turn down the heating, deactivate the fan etc.).
2. Remove the chamber load.
3. Switch off the appliance (Fig. 17).

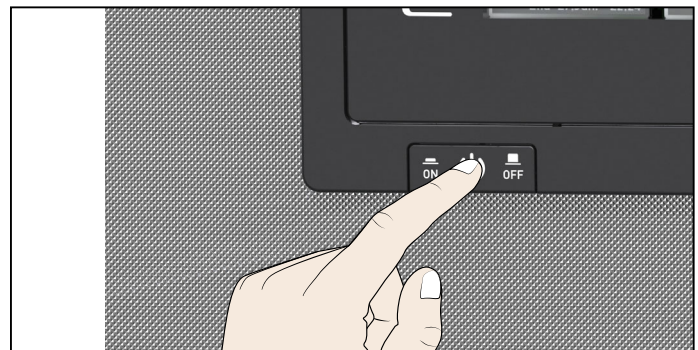

Fig. 17 Switch off appliance

6. Malfunctions, warning and error messages



Warning!

After removing covers, live parts may be exposed. You may receive an electric shock if you touch these parts. Malfunctions requiring work inside the appliance may only be rectified by electricians. Observe the separate service manual for this.

Do not try to rectify appliance errors yourself but contact the MEMMERT customer service department (see page 2) or an authorised service point.

In case of enquiries, please always specify the model and appliance number from the nameplate (see page 12).

6.1 Warning messages of the temperature monitoring function

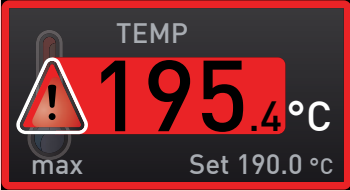
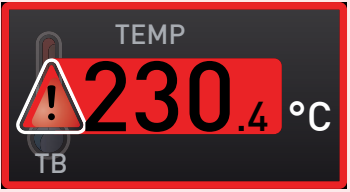
Description	Cause	Action	See
Temperature alarm and max are displayed 	The electronic temperature monitoring system has assumed heating control.	Deactivate the alarm by pressing the confirmation key. Increase the difference between the monitoring and setpoint temperature – by either increasing the monitoring temperature Alarm Temp in the setup or decreasing the setpoint temperature. If the alarm continues: Contact customer service	page 34 page 2
Temperature alarm and TB are displayed 	The mechanical temperature limiter (TB) permanently switched off heating.	Switch off the appliance and leave to cool down. Contact customer service and have the error rectified (e.g. by replacing the temperature sensor).	page 2

6.2 Malfunctions, operating problems and appliance errors

Error description	Cause of errors	Rectifying errors	See
Displays are dark	External power supply was interrupted	Check the power supply	page 19
	Miniature fuse, appliance fuse or power module faulty	Contact customer service	page 2
Individual or all displays cannot be activated	Appliance is in timer mode	Wait for end of timer or deactivate it	
Displays suddenly look different	Appliance is in "wrong" mode	Change to operating or menu mode by pressing the MENU key	
Error message in timer display	Appliance error	Contact customer service	page 2

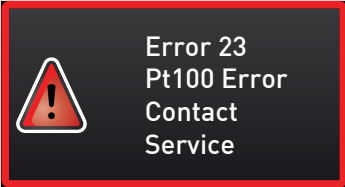

Error 23
Pt100 Error
Contact
Service

6.3 Power failure



Warning!

Depending on the operation performed, the surfaces in the interior and the chamber load may still be very hot after power loss.



Additionally, depending on the duration of the power loss, the appliance might heat up again after power supply has been restored (see below). Touching these surfaces can cause burns. Wear heat-resistant protective gloves or wait until the appliance cools down first.

In case of a power failure, the appliance operates as follows:

In manual mode

After power supply has been restored, operation is continued with the parameters set. The time and the duration of the power failure is documented in the protocol log memory.

In timer mode

In case of an interruption of the power supply of less than 60 minutes, the current timer is continued from the point at which it was interrupted. For interruptions of the power supply longer than this, all appliance functions (heating, fan etc.) are switched off and the air flap is opened.

In timer mode of sterilisers

After power supply has been restored, the timer always starts again.

7. Menu mode

In menu mode, you can make basic settings as well as adjust appliance parameters.

i Caution:

Before changing menu settings, read the description of the respective functions on the following pages to avoid possible damage to the appliance and/or chamber load.

To enter menu mode, press the MENU key.

To exit the menu mode at any time, press the MENU key again. The appliance then returns to manual mode. Only changes accepted by pressing the confirmation key are saved.

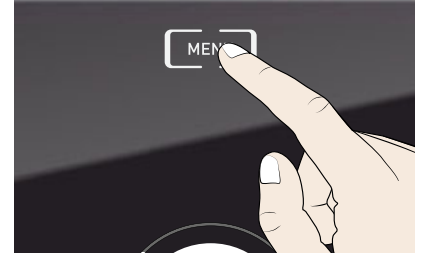

7.1 Overview

Press the MENU key to change between the displays in menu mode:

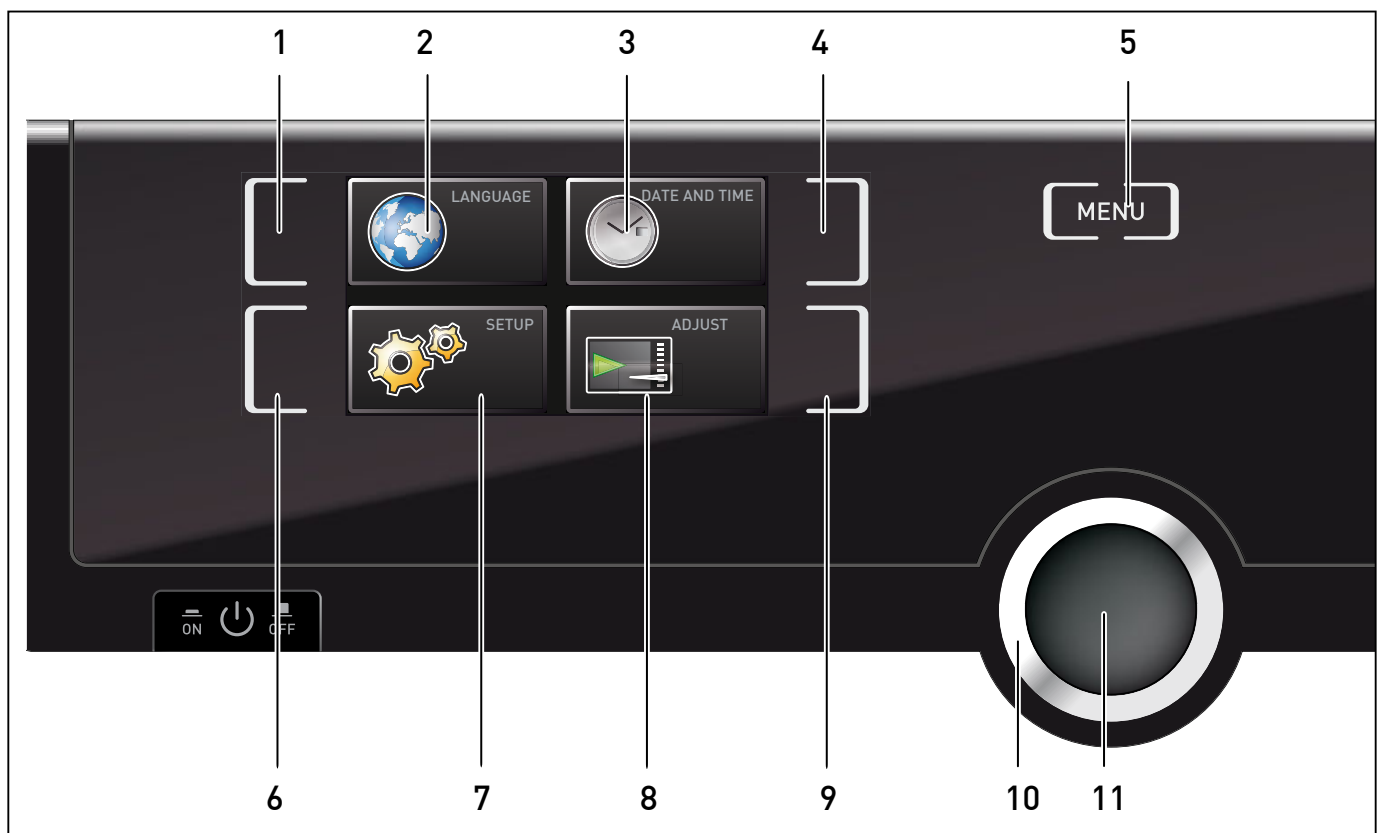

Fig. 18 ControlCOCKPIT in menu mode

- | | |
|---|--|
| 1 Language selection activation key | 7 Setup display (basic appliance settings) |
| 2 Language selection display | 8 Adjustment display |
| 3 Date and time display | 9 Adjustment activation key |
| 4 Date and time setting activation key | 10 Turn control for adjustment |
| 5 Return to manual mode | 11 Confirmation key (accepts setting made with the turn control) |
| 6 Setup activation key (basic appliance settings) | |

7.2 Basic operation in menu mode using the example of language selection

In general, all settings in menu mode are done just like in manual mode: Activate the respective display, use the turn control for setting and press the confirmation key to accept the change. A more detailed description is provided in the following, using the example of language selection.

1. Activate the desired parameter (in this example the language). To do so, press the corresponding activation key on the left or right of the respective display. The activated display is enlarged. The setting currently active – in the example to the right **Deutsch** (German) – is highlighted in colour and indicated by a check mark.

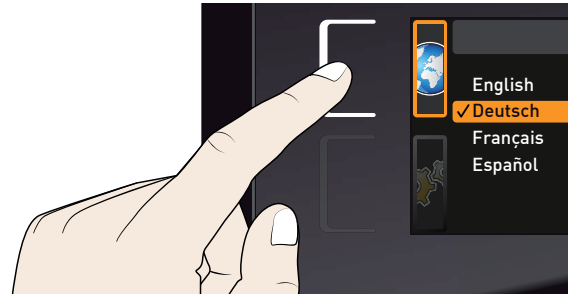

- i** If you want to exit or cancel your settings, again press the activation key which you have used to activate the display. The appliance returns to the menu overview. Only the settings that you have confirmed by pressing the confirmation key before cancelling the setting procedure are accepted.



2. With the turn control, select the desired new setting, e.g. Español (Spanish).

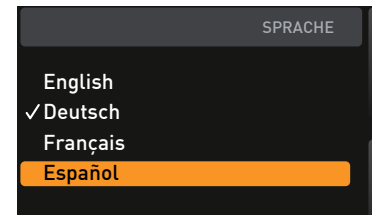
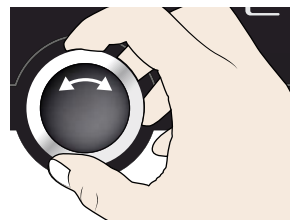

3. Save the setting by pressing the confirmation key.

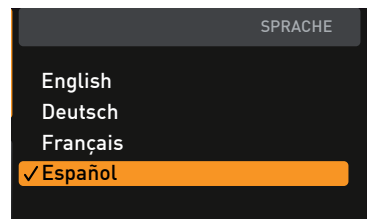
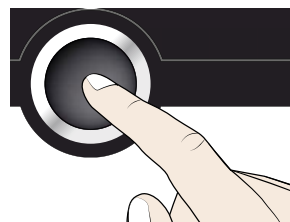

4. To return to the menu overview, press the activation key again.

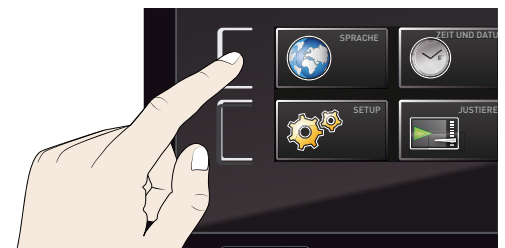

You can now

- ▶ activate another menu function by pressing the corresponding activation key or
- ▶ return to manual mode by pressing the MENU key.

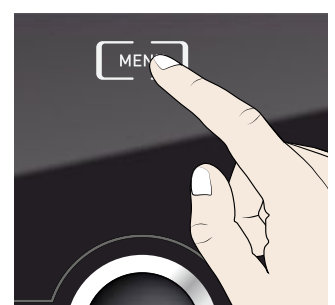
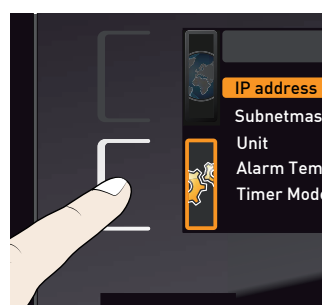

All other settings can be made accordingly. The settings possible are described in the following sections.

i If no new values are entered or confirmed for approx. 30 seconds, the appliance automatically returns to the main menu and restores the former values.

7.3 Setup

In the SETUP display, you can set the following parameters:

- ▶ the IP address and Subnet mask of the appliance's Ethernet interface (for connection to a network)
- ▶ the Unit of the temperature display (°C or °F, see page 33)
- ▶ the trigger temperature of the monitoring function (**Alarm Temp**, see page 34)
- ▶ the **Timer Mode** (see page 35)

7.3.1 IP address

If you want to operate one or more appliances in a network, each appliance must have its own unique IP address for identification. By default, each appliance is delivered with the IP address 192.168.100.100.

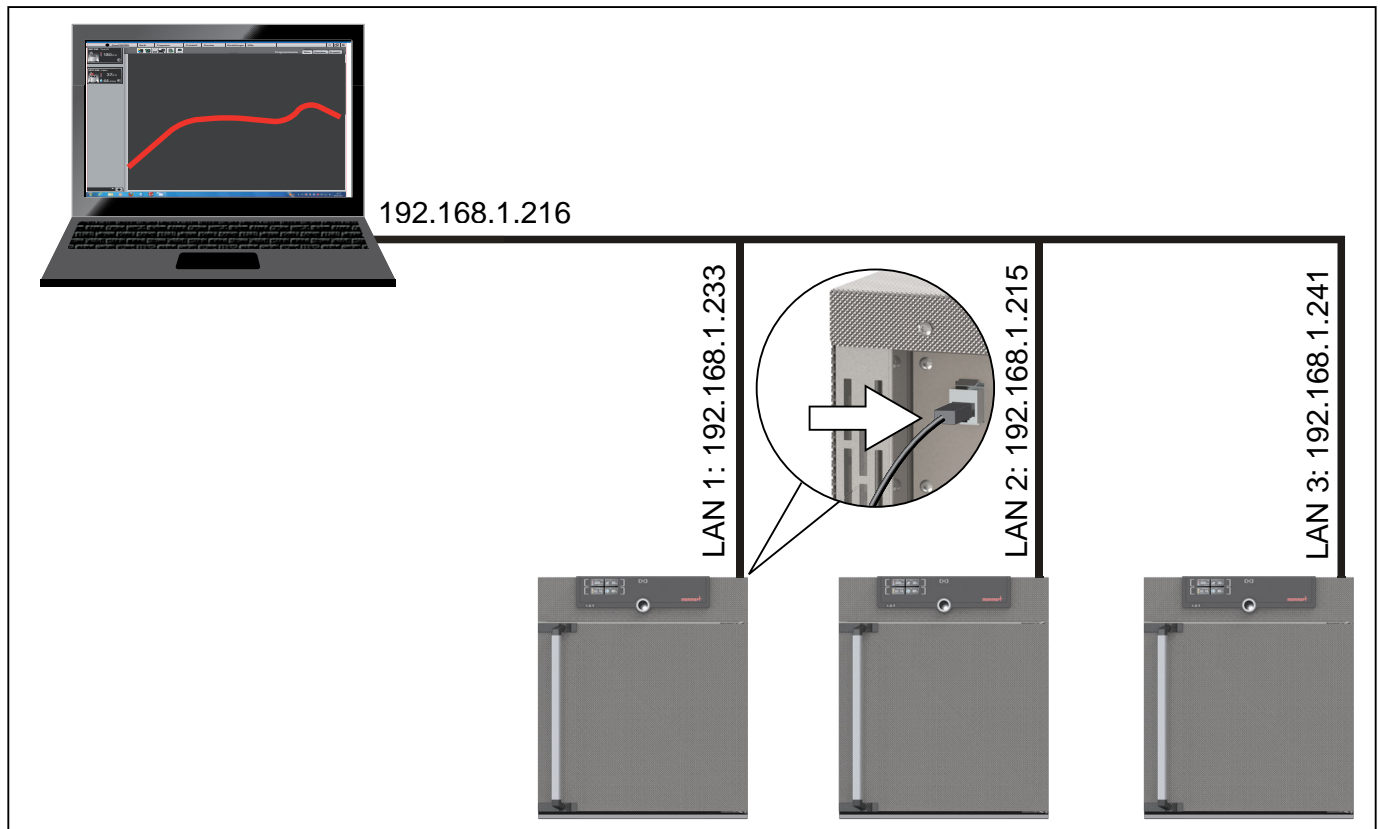
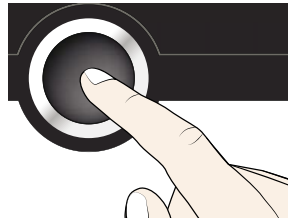

Fig. 19 Operation of several appliances in a network (schematic example)

1. Activate the **SETUP** display. The entry **IP address** is automatically highlighted.



2. Accept the selection by pressing the confirmation key. The first three digits of the IP address are automatically selected.



IP address	192.168.100.100
Subnetmask	255.255.0.0
Unit	<input type="radio"/> °C <input checked="" type="radio"/> °F
Alarm Temp	190 °
Timer Mode	<input checked="" type="radio"/> <input type="radio"/>

3. With the turn control, set the new number, e.g. 255.



IP address	255.168.100.100
Subnetmask	255.255.0.0
Unit	<input type="radio"/> °C <input checked="" type="radio"/> °F
Alarm Temp	190 °
Timer Mode	<input checked="" type="radio"/> <input type="radio"/>

4. Accept the selection by pressing the confirmation key. The next three digits of the IP address are automatically selected. Setting these is done with the turn control according to the description above.

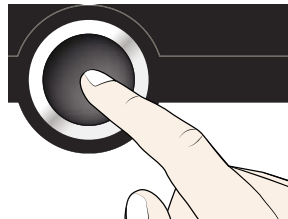

IP address	255.168.100.100
Subnetmask	255.255.0.0
Unit	<input type="radio"/> °C <input checked="" type="radio"/> °F
Alarm Temp	190 °
Timer Mode	<input checked="" type="radio"/> <input type="radio"/>

5. After setting the last three digits, accept the new IP address by pressing the confirmation key. The selection returns to the overview.

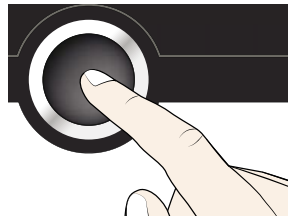

IP address	255.145.136.225
Subnetmask	255.255.0.0
Unit	<input type="radio"/> °C <input checked="" type="radio"/> °F
Alarm Temp	190 °
Timer Mode	<input checked="" type="radio"/> <input type="radio"/>

The subnet mask is set accordingly.

7.3.2 Unit

Here, you can choose whether the temperature is displayed in °C or °F.

1. Activate the **SETUP** display and select **Unit** with the turn control.

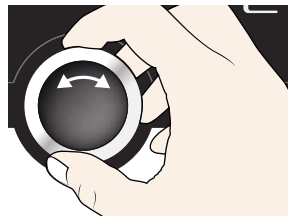

IP address	255.145.136.225
Subnetmask	255.255.0.0
Unit	<input type="radio"/> °C <input checked="" type="radio"/> °F
Alarm Temp	190 °
Timer Mode	<input checked="" type="radio"/> <input type="radio"/>

2. Accept the selection by pressing the confirmation key. The adjustment options are automatically highlighted.

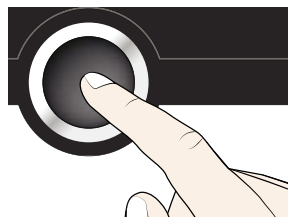

IP address	255.145.136.225
Subnetmask	255.255.0.0
Unit	<input checked="" type="radio"/> °C <input type="radio"/> °F
Alarm Temp	190 °
Timer Mode	<input checked="" type="radio"/> <input type="radio"/>

3. With the turn control, select the desired unit – in this example °C.



IP address	255.145.136.225
Subnetmask	255.255.0.0
Unit	<input checked="" type="radio"/> °C <input type="radio"/> °F
Alarm Temp	190 °
Timer Mode	<input checked="" type="radio"/> <input type="radio"/>

- Save the setting by pressing the confirmation key.

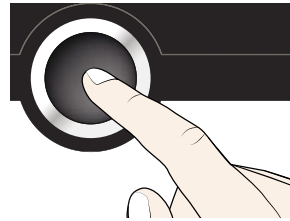

IP address	255.145.136.225
Subnetmask	255.255.0.0
Unit	<input checked="" type="radio"/> °C <input type="radio"/> °F
Alarm Temp	190 °
Timer Mode	<input checked="" type="radio"/> <input type="radio"/>

7.3.3 Temperature monitoring (Alarm Temp)

Here, you can set the trigger temperature of the automatic temperature monitoring system (description on page 26 and following).

i The monitoring temperature must be set sufficiently high above the maximum set temperature. We recommend 5 to 10 K difference for UN/UF/SN/SF and 1 to 3 K difference for IN/IF.

- Activate the **SETUP** display and select **Alarm Temp** with the turn control.

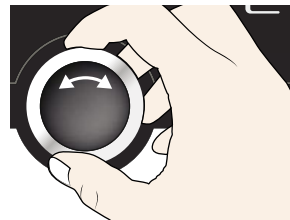

IP address	255.145.136.225
Subnetmask	255.255.0.0
Unit	<input type="radio"/> °C <input type="radio"/> °F
Alarm Temp	190 °
Timer Mode	<input checked="" type="radio"/> <input type="radio"/>

- Accept the selection by pressing the confirmation key. The current settings are automatically highlighted.

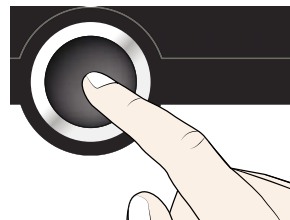

IP address	255.145.136.225
Subnetmask	255.255.0.0
Unit	<input type="radio"/> °C <input type="radio"/> °F
Alarm Temp	190 °
Timer Mode	<input checked="" type="radio"/> <input type="radio"/>

- With the turn control, select the desired new trigger temperature - in this example 160 °.

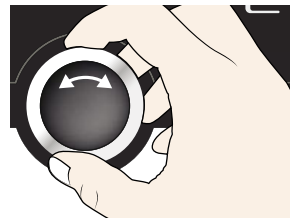

IP address	255.145.136.225
Subnetmask	255.255.0.0
Unit	<input type="radio"/> °C <input type="radio"/> °F
Alarm Temp	160 °
Timer Mode	<input checked="" type="radio"/> <input type="radio"/>

- Save the setting by pressing the confirmation key. The electronic temperature monitoring system will now be triggered when the actual temperature reaches 160 °C.

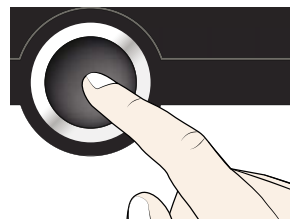

IP address	255.145.136.225
Subnetmask	255.255.0.0
Unit	<input type="radio"/> °C <input type="radio"/> °F
Alarm Temp	160 °
Timer Mode	<input checked="" type="radio"/> <input type="radio"/>

7.3.4 Timer Mode

For universal ovens UN/UF and incubators IN/IF, you can choose if the timer (see page 24) should run setpoint-dependent or not – this determines if the timer should not start until a tolerance band of ± 3 K around the set temperature is reached (Fig. 20, B) or if it should start right after activation (A).

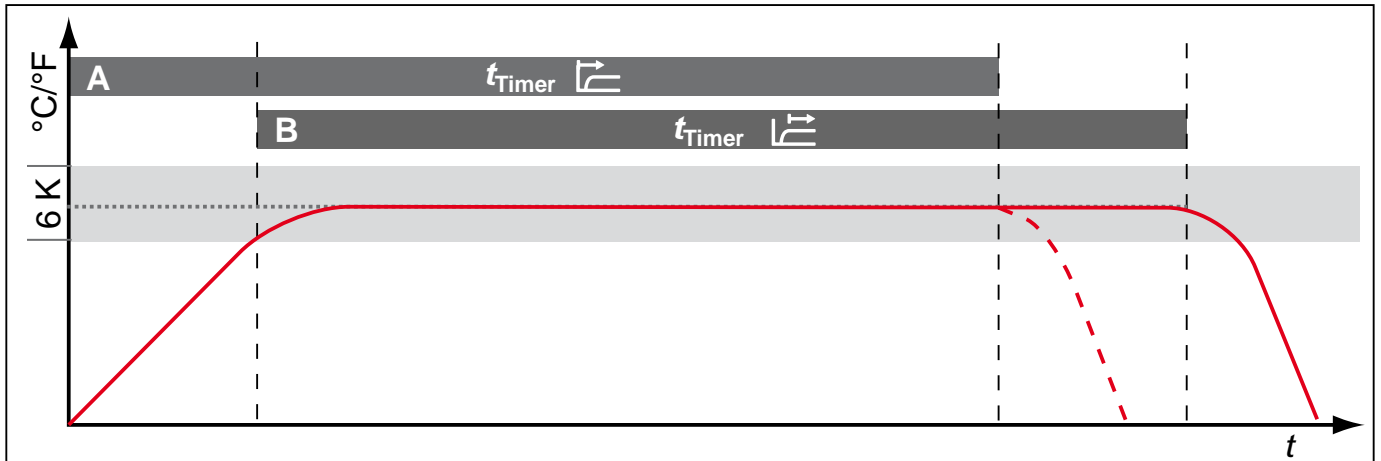

Fig. 20 Timer Mode

A Timer independent of setpoint: Timer starts right after activation

B Timer setpoint-dependent: Timer does not start until tolerance band is reached

i For sterilisers SN/SF, the timer is by default setpoint-dependent. To ensure that the required temperature is maintained for a sufficient period of time, this setting cannot be changed. If the temperature is no longer within the tolerance band, the sterilisation time is, for reasons of safety, restarted as soon as the required temperature is reached again. For universal ovens UN/UF and incubators IN/IF, the timer is in this case interrupted and resumed as soon as the required temperature is reached again.

Setting

1. Activate the **SETUP** display and select **Timer Mode** with the turn control.



IP address	255.145.136.225
Subnetmask	255.255.0.0
Unit	<input checked="" type="radio"/> °C <input type="radio"/> °F
Alarm Temp	160 °
Timer Mode	<input type="radio"/> <input checked="" type="radio"/>

2. Accept the selection by pressing the confirmation key. The adjustment options are automatically highlighted.

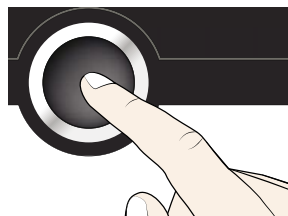

IP address	255.145.136.225
Subnetmask	255.255.0.0
Unit	<input type="radio"/> °C <input checked="" type="radio"/> °F
Alarm Temp	160 °
Timer Mode	<input checked="" type="radio"/> <input type="radio"/>

3. With the turn control, select the desired setting – in this example Timer independent of setpoint ().

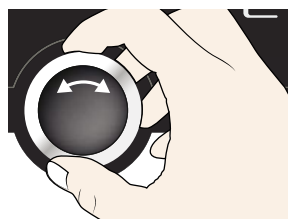

IP address	255.145.136.225
Subnetmask	255.255.0.0
Unit	<input checked="" type="radio"/> °C <input type="radio"/> °F
Alarm Temp	160 °
Timer Mode	<input checked="" type="radio"/> <input type="radio"/>

- Save the setting by pressing the confirmation key.

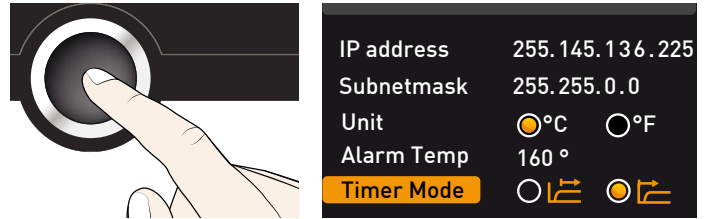

7.4 Date and time

In the **DATE AND TIME** display, you can set the date and time, time zone and daylight savings.

- Activate the time setting To do so, press the activation key on the right side of the **DATE AND TIME** display. The display is enlarged and the first adjustment option (**Date**) automatically highlighted. On the right, the current settings are shown.



- i** If you want to change another setting – e.g. the time zone: Turn the turn control until the corresponding entry is highlighted.

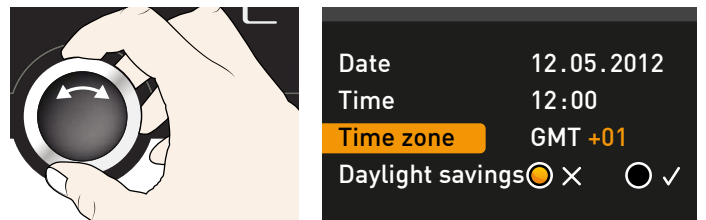

- Accept the selection by pressing the confirmation key. The first value – in this case the day – is automatically highlighted in orange.

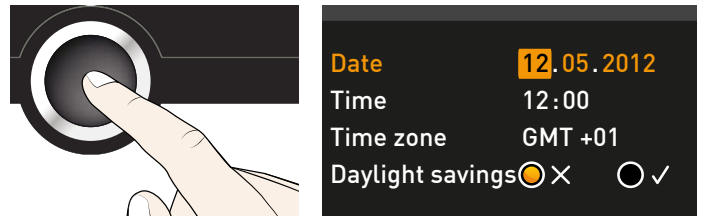

- With the turn control, set the current day, e.g. 27.

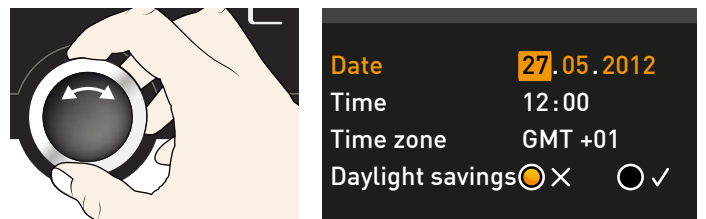

- Save the setting by pressing the confirmation key. The month is automatically highlighted. You can change it with the turn control.

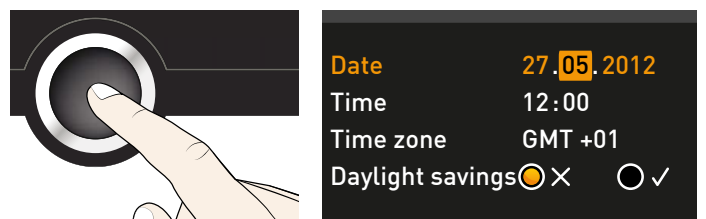

Accordingly, you can also set:

- ▶ Year
- ▶ Hour and minute
- ▶ Time zone GMT (e.g. +1 in Germany, see Fig. 21)
- ▶ Daylight savings

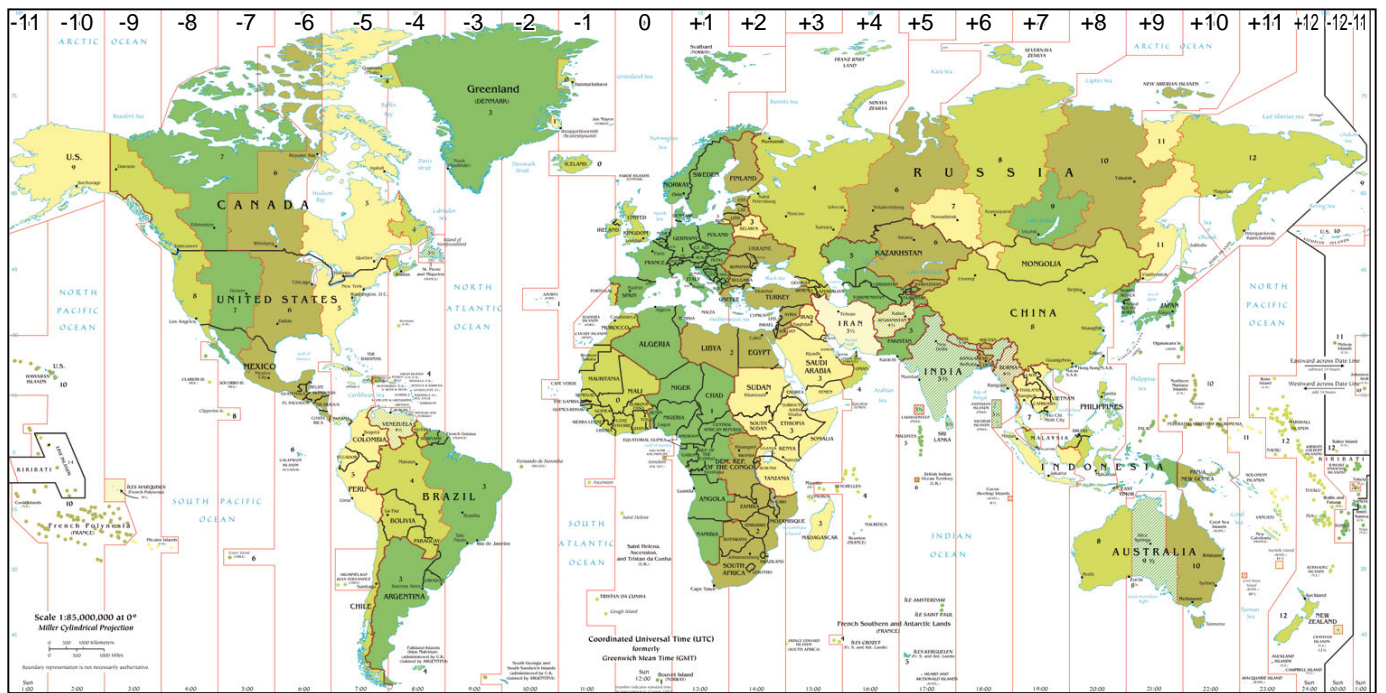

Fig. 21 Time zones

7.5 Adjustment

The appliances are temperature calibrated and adjusted at the factory. In case readjustment should be necessary later on – for example due to influence of the chamber load – the appliance can be calibrated customer-specifically using three calibration temperatures of your choice:

- ▶ CAL1 Temperature calibration at low temperature
- ▶ CAL2 Temperature calibration at medium temperature
- ▶ CAL3 Temperature calibration at high temperature

i For temperature adjustment, you will need a calibrated reference measuring device.

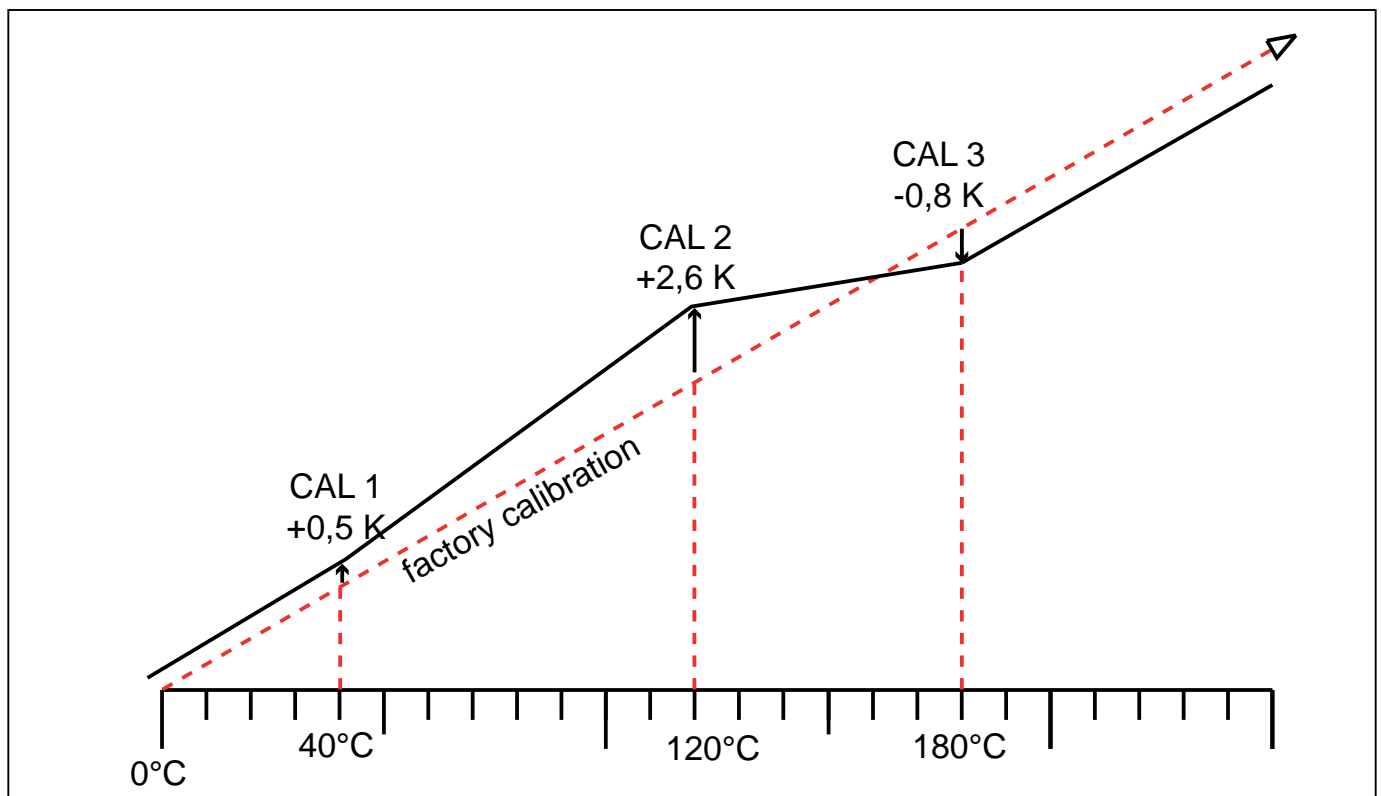
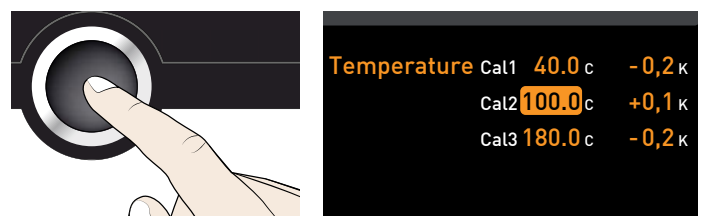
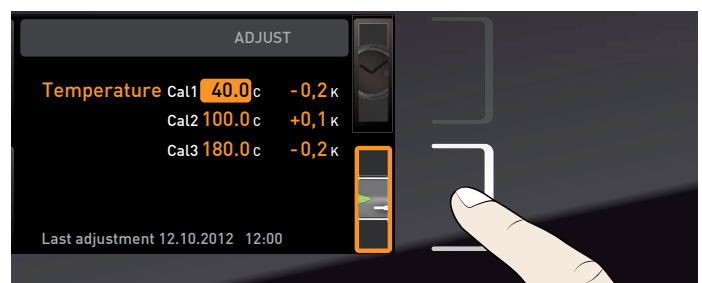

Fig. 22 Schematic example of temperature adjustment

Example: Temperature deviation at 120 °C should be corrected.

1. Activate the adjustment setting. To do so, press the activation key on the right side of the **ADJUST** display. The display is enlarged and the first calibration temperature – in this case 40 °C – automatically highlighted.
2. Press the confirmation key repeatedly, until the calibration temperature **CAL2** is selected.



3. With the turn control, set the calibration temperature CAL2 to 120 °C.

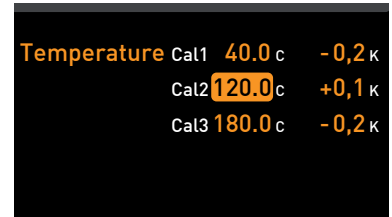
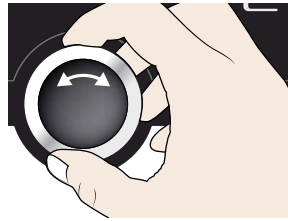

4. Save the setting by pressing the confirmation key. The corresponding calibration value is automatically highlighted.

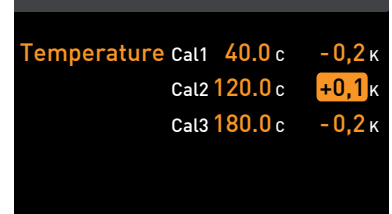
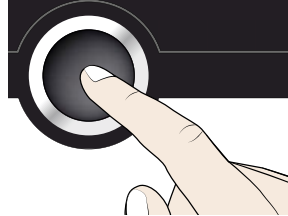

5. Set the calibration value to 0.0 K and accept the setting by pressing the confirmation key.

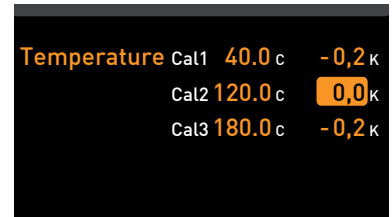
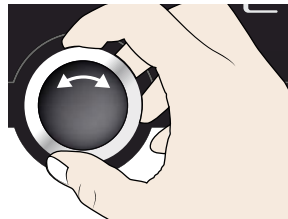

6. Position the sensor of a calibrated reference instrument centrally in the appliance's working chamber.

7. Close the door and, in manual mode, adjust the set temperature to 120 °C.

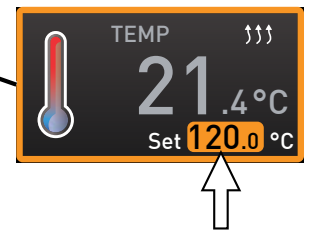
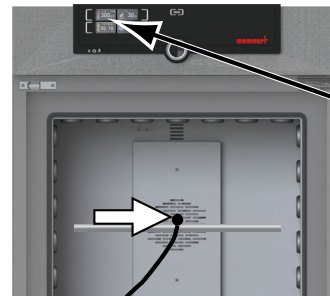

8. Wait until the appliance reaches the set temperature and displays 120 °C. The reference instrument should display 122.6 °C.

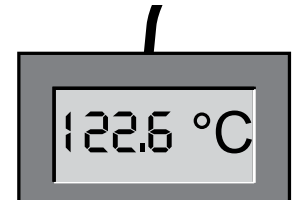
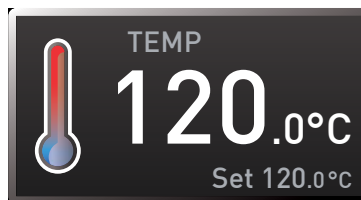

9. In the SETUP, adjust the calibration value CAL2 to +2.6 K (actual value measured minus setpoint temperature) and save the setting by pressing the confirmation key.

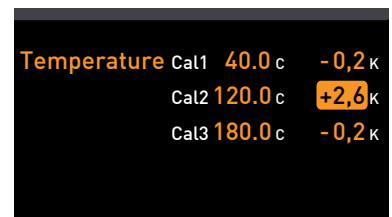
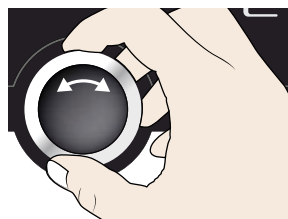

10. After the calibration procedure, the temperature measured by the reference instrument should now also be 120 °C.

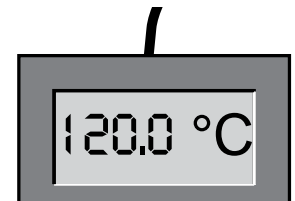
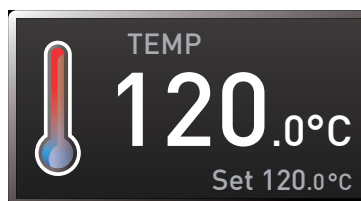

With CAL1, a calibration temperature below CAL2 can be programmed accordingly, and with CAL3, a temperature above. The minimum difference between the CAL values is 20 K for universal ovens UN plus/UF plus as well as sterilisers SN/SF and 10 K for incubators IN/IF.

i If all calibration values are set to 0.0 K, the factory calibration settings are restored.

8. Sterilisers SF/SN

8.1 Intended use

The SF/SN appliance serves for sterilising medical material through dry heated air at atmospheric pressure.

8.2 Note in accordance with Medical Devices Directive

The product lifetime as intended by the manufacturer is eight years.

8.3 Guidelines for sterilisation

For hot air sterilisation, there are different guidelines on the temperature and sterilisation time to choose, as well as on packaging the sterilisation load. The values to be chosen depend on the type and characteristics of the load to be sterilised and on the type of germs to be neutralised. Before beginning sterilisation, make yourself familiar with the sterilisation method laid down for your application.

Process parameters for hot air sterilisers are temperature and minimum hold time. The following process parameters have been defined in recognised standards:

- ▶ According to WHO: 180 °C with a minimum hold time of 30 min
- ▶ According to the European Pharmacopoeia: 160 °C with a minimum hold time of 120 min

For the inactivation of endotoxin (pyrogenes), dry heat of at least 180 °C can be applied. For the depletion of pyrogenic substances, you have to keep a combination of temperature and time going beyond the requirements of sterilisation.

Inactivation of endotoxin is possible using the following process parameters (data in accordance with ISO 20857:2010):

- ▶ 180 °C with a minimum effective time of 180 min
- ▶ 250 °C with a minimum effective time of 30 min

Caution:

The temperature and time requirements normal for hot air sterilisation do not destroy endotoxins.

Especially when the appliance is heavily loaded, using these parameters without checking them will not be sufficient. For safe sterilisation, validation of the individual sterilisation process is required. The requirements for the validation of sterilisation by dry heat are e.g. defined in standard ISO 20857:2010. Also valuable is the "guideline on validation and routine monitoring of sterilisation processes using dry heat for medical products" issued by the German Society for Hospital Hygiene (DGKH).

9. Maintenance and service

9.1 Cleaning

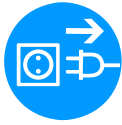
**Warning!**

Danger of injury by electric shock. Before any cleaning work, pull out the mains plug.

**Warning!**

In case of appliances of a certain size, you can get accidentally locked in, which is life-threatening. Do not climb into the appliance!

9.1.1 Working chamber and metal surfaces

Regular cleaning of the easy-to-clean working chamber prevents build up of material remains that could impair the appearance and functionality of the stainless steel working chamber over time.

The metal surfaces of the appliance can be cleaned with normal stainless steel cleaning agents. Make sure that no rusty objects come into contact with the working chamber or with the stainless steel housing. Rust deposits can lead to an infection of the stainless steel. If rust spots should appear on the surface of the working chamber due to impurities, the affected area must be immediately cleaned and polished.

9.1.2 Plastic parts

Do not clean the ControlCOCKPIT and other plastic parts of the appliance with caustic or solvent-based cleaning agents.

9.1.3 Glass surfaces

Glass surfaces can be cleaned with a commercially available glass cleaner.

9.2 Regular maintenance

Once a year, grease the moving parts of the doors (hinges and lock) with thin silicone grease and check that the hinge screws are not loose.

9.3 Repairs and service

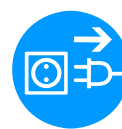
**Warning!**

After removing covers, live parts may be exposed. You may receive an electric shock if you touch these parts. Disconnect the mains plug before removing any covers. Any work inside the appliance may only be performed by qualified electricians.



Repairs and service work are described in a separate service manual.

10. Storage and disposal

10.1 Storage

The appliance may only be stored under the following conditions:

- ▶ in a dry and enclosed, dust-free room
- ▶ frost-free
- ▶ disconnected from the power supply

10.2 Disposal

This product is subject to the Directive 2002/96/EC on Waste Electrical and Electronic Equipment (WEEE) of the European Parliament and of the Council. This appliance has been brought to market after August 13th, 2005 in countries which have already integrated this directive into their national laws. It may not be disposed of in normal household waste. For disposal, please contact your dealer or the manufacturer. Any appliances that are infected, infectious or contaminated with materials hazardous to health are excluded from return. Please also observe all other regulations applicable in this context.

Note for Germany:

The appliance may not be left at public or communal recycling or collection points.

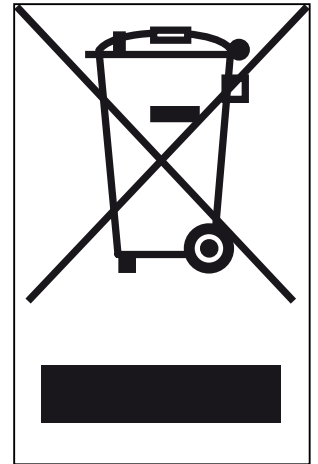

Index

- A**
 - Accessories 15
 - Activation key 23
 - Adjustment 38
 - Air flap position 24
 - Air supply 11
 - Alarm 34
 - Alarm temperature 34
 - Ambient conditions 14
 - Ambient temperature 14
 - Appliance error 29
 - AtmoCONTROL 3, 12, 15
- B**
 - Basic device settings 30
 - Basic settings 30
- C**
 - Carrying 16
 - Cause of errors 29
 - Chamber load 21
 - Changes 9
 - Cleaning 41
 - Communication interfaces 12
 - Compensation correction value 39
 - Connections 12
 - ControlCOCKPIT 22
 - Convection 11
 - Customer service 2
- D**
 - Daylight savings 36
 - Decommissioning 42
 - Delivery 16, 19, 40
 - Dimensions 14
 - Disposal 42
 - Door 20
- E**
 - Electrical connection 12
 - Electrical connections 19
 - Electronic temperature monitoring 26
 - Emergency 9
 - Ending operation 27
 - Error description 29
 - Error message 29
 - Error messages 28
- Explosion protection 8
- F**
 - factory calibration 39
 - Fan speed 24
 - Forklift truck 16
 - Function 11
- G**
 - GMT 36
 - Graph 27
- H**
 - Hazards 7
- I**
 - Installation site 17
 - Intended use 8
 - Interfaces 12
 - IP address 32
- L**
 - Language selection 31
 - Loading the appliance 21
 - Log memory 29
- M**
 - Maintenance 41
 - Malfunctions 9, 28
 - Manufacturer 2
 - Material 11
 - Mechanical temperature monitoring 26
 - Medical device 8
 - Medical Devices Directive 40
 - Menu 30
 - Minimum clearances 17
 - Monitoring temperature 26
- N**
 - Nameplate 12
 - Network 12, 32
 - Normal mode 23, 24
- O**
 - Operating 20
 - Operating modes 23
 - Operating personnel 7, 20
 - Operating problems 29
 - Operation 20
- P**
 - Packaging material 16
 - Power failure 29
 - Product safety 7
 - Pt100 temperature sensor 26
 - Putting into operation 19, 40
- R**
 - Rectifying errors 29
 - Regular maintenance 41
- S**
 - Safety regulations 6
 - Service 41
 - Servicing 41
 - Setting parameters 23, 31
 - Setting up 16, 17
 - Setup 32
 - Sterilisers 3, 20, 25, 35, 40
 - Storage after delivery 17
 - Switching off 27
 - Switching on 19
- T**
 - TB 26
 - Technical data 13
 - Temperature 24
 - Temperature comparison 38
 - Temperature deviation 38
 - Temperature limiter 26
 - Temperature monitoring 26, 34
 - Temperature sensor 26
 - Time 36
 - Timer mode 35
 - Timer operation 24
 - Time zone 36
 - Transport 16
 - Transport damage 16
 - Turn control 23
- U**
 - Unit 33
 - Unpacking 16
- W**
 - Warning messages 12, 28
 - Weight 13



memmert
Experts in Thermostatics

Universal ovens

Incubators

Sterilisers

07.09.2012

D24022 // englisch

Memmert GmbH + Co. KG
Postfach 1720 | D-91107 Schwabach
Tel. +49 9122 925-0 | Fax +49 9122 14585
E-Mail: sales@memmert.com
[facebook.com/memmert.family](https://www.facebook.com/memmert.family)
Die Experten-Plattform: www.atmosafe.net