

User Manual

# Secura<sup>®</sup>, Quintix<sup>®</sup>

26, 35, 65, 125, 125D, 225D, 324

Laboratory Balances

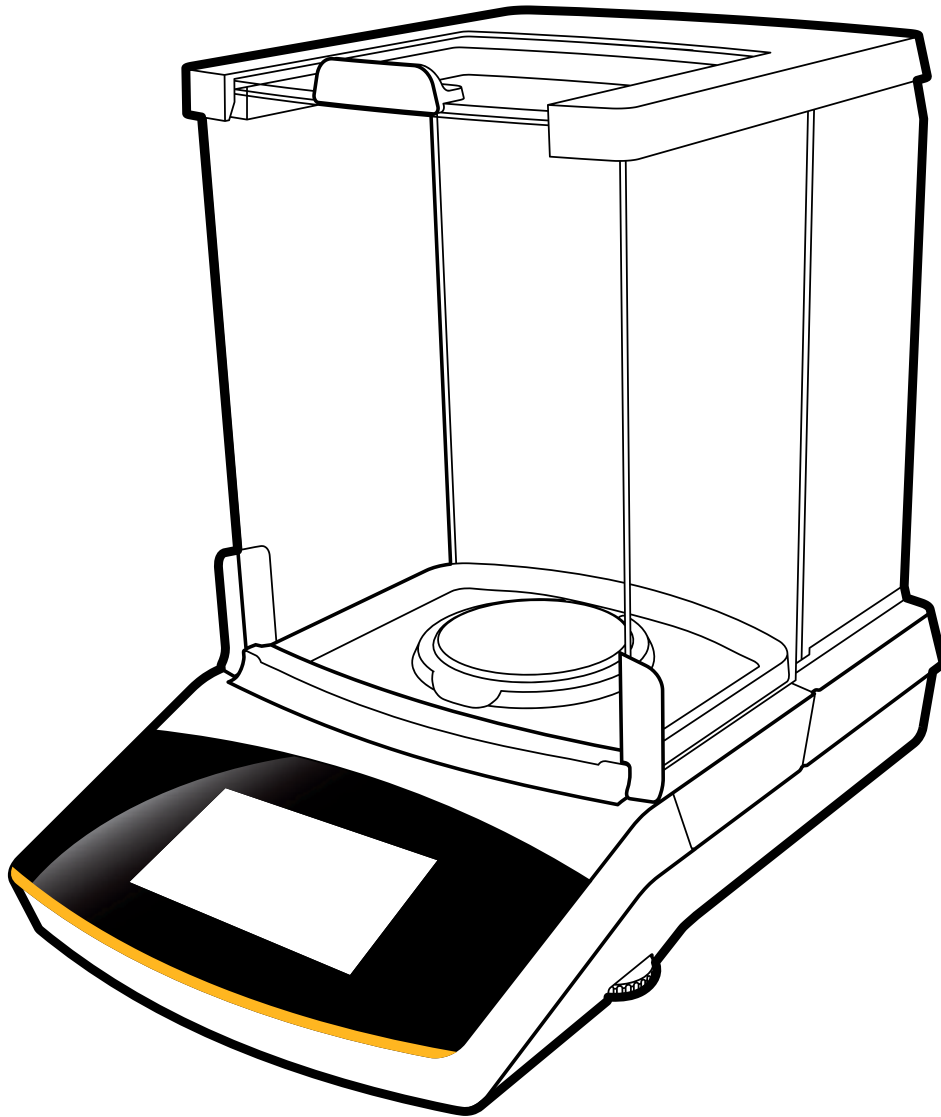



# Contents

<b>1. User Information</b> .....	4	<b>7. Weighing</b> .....	40
1.1 Warning/Danger Symbols.....	4	7.1 Mass Unit Conversion.....	41
1.2 Explanation of Symbols.....	4	7.2 SQmin Minimum Weighing (Secura® only).....	43
1.3 Application Advice/Technical Support.....	5	7.3 Individual Identifiers (Secura® only).....	44
<b>2. Safety Information</b> .....	6	7.4 Mixing.....	45
2.1 Guidelines and General Information.....	6	7.5 Statistics.....	48
2.2 Installation Information.....	6	7.6 Totalizing Components.....	51
2.3 Intended Use.....	7	7.7 Density.....	54
<b>3. General View of the Equipment</b> .....	8	7.8 Percentage.....	58
<b>4. Getting Started</b> .....	9	7.9 Conversion.....	61
4.1 Unpacking and Equipment Supplied.....	9	7.10 Unstable Condition.....	63
4.2 Installing the Balance.....	10	7.11 Checkweighing.....	65
4.3 Choosing a Location.....	12	7.12 Peak Hold.....	67
4.4 Moving the Balance.....	13	7.13 Counting.....	69
4.5 AC Power Supply.....	14	<b>8. Calibration and Adjustment</b> .....	72
4.6 Warm-up Time.....	15	8.1 Calibration/Adjustment Using an Internal Calibration Weight.....	73
4.7 Switching On the Balance.....	16	8.2 Calibration/Adjustment Using an External Calibration Weight.....	74
4.7.1 Startup Wizard.....	16	8.3 Automatic Calibration/Adjustment with isoCAL.....	75
4.8 Anti-theft Locking Device.....	18	<b>9. ISO/GLP-compliant Printout</b> .....	76
<b>5. Using the Balance</b> .....	19	<b>10.USB Port</b> .....	78
5.1 Switching the Balance On/Off (Standby).....	19	10.1 Communication with Peripheral Devices.....	78
5.2 Leveling the Balance.....	20	10.2 Direct Transfer of Data (PC).....	79
5.2.1 Leveling with Electronic Level Indicator (Secura®).....	20	10.3 Interface Specification.....	85
5.2.2 Leveling with a Conventional Level Indicator (Quintix®).....	21	10.3.1 Data Output.....	85
5.3 Operating Concept.....	22	10.3.2 Data Output Formats.....	85
5.3.1 Operating and Display Elements.....	22	10.3.3 Data Output Format with 22 Characters.....	87
5.3.2 Menu.....	23	10.3.4 Data Input.....	88
5.3.3 Entering Figures on the Number Pad.....	24	10.3.5 Overview of Interface Commands.....	89
5.3.4 Entering Text and Characters (Secura® only).....	24	<b>11.Status Messages</b> .....	90
5.3.5 Accessing an Application in the Menu.....	25	11.1 Key Fadeout.....	90
5.3.6 List of Applications in the Menu.....	25	11.2 Application Error Messages.....	90
<b>6. System Settings (Setup Menu)</b> .....	27	<b>12.Transporting the Balance</b> .....	92
6.1 Accessing the Menu and Changing Settings.....	27	12.1 Detaching the Draft Shield/Weighing Pan.....	92
6.2 List of Available Settings.....	28	12.2 Packing the Balance.....	93
6.2.1 Language.....	28	<b>13.Care and Maintenance</b> .....	94
6.2.2 Date and Time.....	29	13.1 Service.....	94
6.2.3 Device Information.....	30	13.2 Cleaning the Balance.....	94
6.2.4 Calibration/Adjustment.....	30	<b>14.Disposal</b> .....	97
6.2.5 Weighing.....	30	<b>15.Specifications</b> .....	98
6.2.6 Printout.....	33	15.1 General Data.....	98
6.2.7 Identifier (Secura® only).....	34	15.2 Model-specific Data.....	100
6.2.8 USB Port.....	35	15.3 Verified Models with Country-specific Type Approval Certificate.....	101
6.2.9 Display Brightness.....	37	15.4 Accessories.....	103
6.2.10 Acoustic Signal.....	37	15.5 Balance Dimensions.....	104
6.2.11 More Settings.....	38	15.5.1 Secura®, Quintix®.....	104
		15.5.2 Secura® 26.....	105
		<b>Appendix</b> .....	106

# 1. User Information

## 1.1 Warning/Danger Symbols

Warning and danger symbols used in these instructions:



These notes identify hazards which have a high probability of resulting in death or serious physical injury if not avoided.



These notes identify hazards that can result in moderate or mild injuries if not avoided.



These notes identify hazards associated with the risk of material damage.

## 1.2 Explanation of Symbols

The following symbols are used in this manual:



Useful information and tips



Notes for use in legal metrology. For instruments the conformity assessment procedure has been performed (verified balances)



Note regarding device operation



When individual buttons are displayed, they should be pressed.

The following symbols are used in these instructions:

- ▶ Indicates a required action
- ▷ Describes what happens after you have performed a particular step

Perform steps in the specified order:

1. First action
  2. Second action
  3. ...
- Indicates an item in a list

Conventions for this User Manual:

- The illustrations in these instructions are based on "Standard" balances. On balances verified for use in legal metrology, some displays and reports may deviate slightly from the figures. Where this is significant for operation, the differences will be explained in the text.

### **1.3 Application Advice/Technical Support**

Contact addresses for application advice and our technical support can be found online at: <http://www.sartorius.com>

## 2. Safety Information

### 2.1 Guidelines and General Information

- The balance complies with EU Directives and standards for electrical safety and electromagnetic compatibility\*. Improper use or handling, however, can result in damage and/or injury. Any improper use or operation of the balance, i.e., that is not consistent with the instructions, will result in forfeiture of all claims under the manufacturer's warranty.
- Personnel need to have read and understood these installation instructions, including the safety instructions.
- In the event of use in systems and ambient conditions which have greater safety requirements, you must observe the requirements and provisions applicable in your country.
- Always keep the equipment and balance freely accessible.  
Any installation work or balance operation that does not conform to the instructions will result in forfeiture of all claims under the manufacturer's warranty.

\* = see "Specifications"



#### **Danger of Explosion!**

Do not use this equipment in hazardous areas in which explosive materials are present.



Make sure that the voltage rating printed on the AC adaptor is identical to your local mains voltage.

### 2.2 Installation Information



Do not operate the balance if its housing or AC adaptor is damaged. Immediately disconnect the damaged device from the power by pulling the plug.



Do not expose the balance, its AC adaptor or the accessories supplied by Sartorius to extreme temperatures, aggressive chemical vapors, moisture, shocks, vibrations or strong electromagnetic fields.

Observe the conditions of operation described in the Specifications.



#### Note on Installation:

The operator shall be solely responsible for any modifications to the equipment and for connecting any cables or equipment not supplied by Sartorius.

Information on operational quality is available upon request from Sartorius.

You should only use peripherals supplied by Sartorius.

Note the IP protection class of the balance and its AC adaptor. Do not allow liquid penetration. The protection class specifies the suitability of equipment for various environmental conditions (moisture, foreign bodies).



Before cleaning the AC adaptor or the balance: Unplug from the mains power.

The balance may only be opened by specialized personnel trained by Sartorius. Do not open the AC adaptor.

**Hazards during Installation and Operation:**

If glass breaks, there is a risk of injury posed by cuts from glass edges.



Lay the cables where they pose no risk of causing someone to trip.

Observe the additional safety and danger information in the following chapters.

## 2.3 Intended Use

This high-precision balance is designed to be used exclusively indoors under normal atmospheric conditions.

It was developed specifically for the exact determination of the mass of materials in liquid, paste, powder or solid form.

Appropriate containers must be used for each type of sample material.

### 3. General View of the Equipment

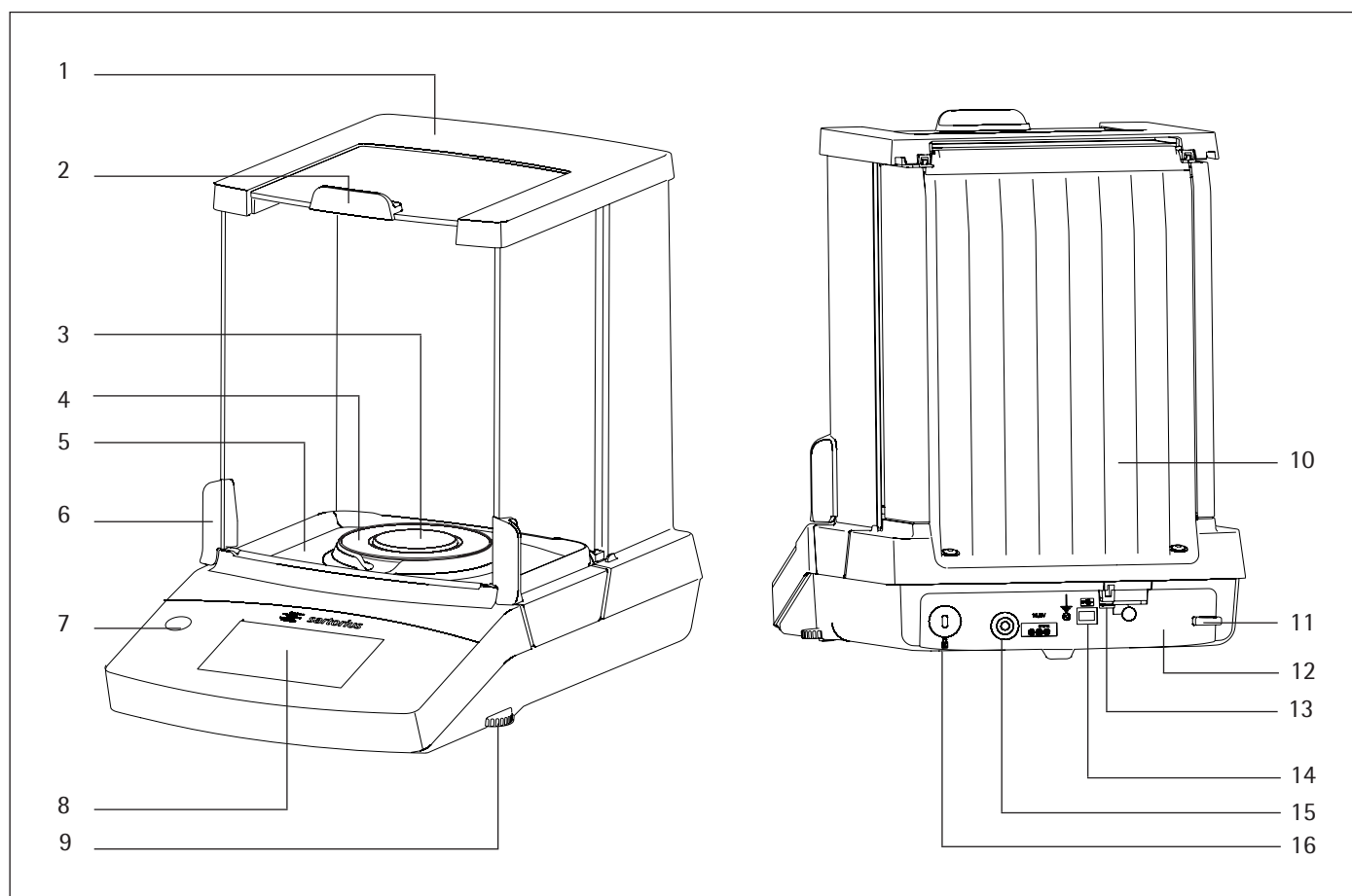

No.	Name and Function
1	Cover
2	Grip, upper panel (draft shield)
3	Weighing pan
4	Shield disk (Secura® 26)
5	Collection container
6	Grip, side panel (draft shield)
7	Level indicator (Quintix® model)
8	Touchscreen

No.	Name and Function
9	Leveling feet
10	Rear device cover (only for service)
11	Manufacturer's ID label, for verified models Additional ID label
12	Lug for attaching anti-theft device
13	Verification access switch: Blocks various functions and units on verified balances
14	USB port for mini AB
15	DC jack
16	Fastening point for "Kensington" key lock (optional)



## 4. Getting Started

**IMPORTANT**

The balance must be disconnected from the mains power for all assembly work.

### 4.1 Unpacking and Equipment Supplied

- ▶ Open the packaging, making sure to remove all parts carefully.
- ▶ After unpacking the balance, check it immediately for any external damage.
- ▷ If you detect any damage, proceed as directed in the chapter entitled "Care and Maintenance."
- ▷ Save all parts of the original packaging for any future transportation. During shipment, please do not leave cables plugged in!

The following parts are included in the equipment supplied:

Components	Secura®			Quintix®	
	26	225D 125	324	125D 65	35
Draft shield (4 panels)	✓	✓	✓	✓	✓
Collection container	✓	✓	✓	✓	✓
Weighing pan: Ø 80 mm	-	✓	-	✓	✓
Weighing pan: Ø 90 mm	-	*	✓	*	*
Weighing pan: Ø 50 mm	✓	-	-	-	-
Shield disk (normal / high)	✓	-	-	-	-
AC adapter with country-specific power plug	✓	✓	✓	✓	✓
In-use dust cover	✓	✓	✓	✓	✓
Dust cover	✓	✓	✓	✓	✓
Installation and operating instructions	✓	✓	✓	✓	✓
Application guide	✓	✓	✓	✓	✓

\* optional

## 4.2 Installing the Balance

### Installing the Collection Container

- ▶ Insert the collection container into the balance.

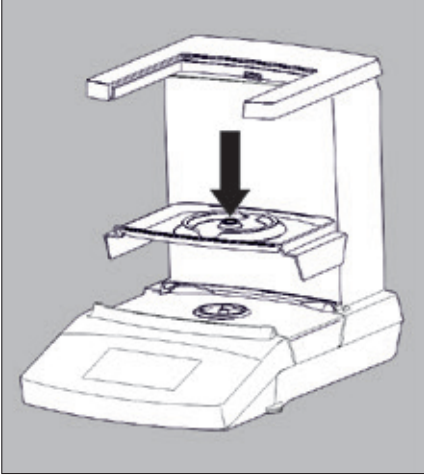

### Installing the Panels (Draft Shield)

- ▶ Press against the front of the cover from both sides and fold it upwards.

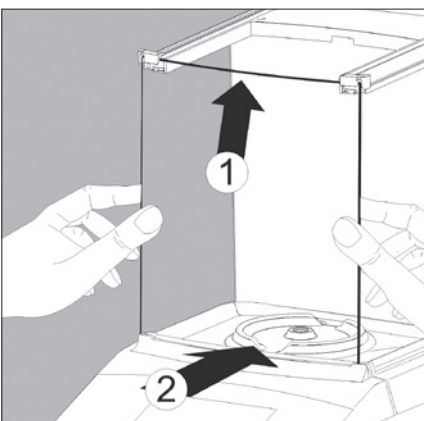
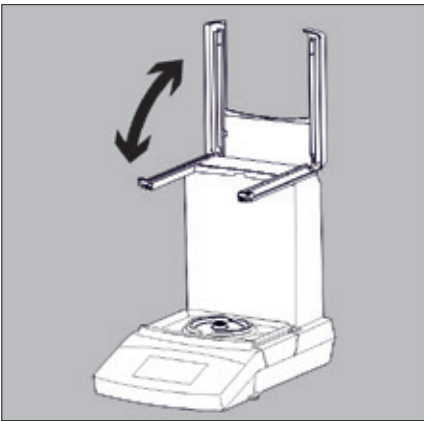
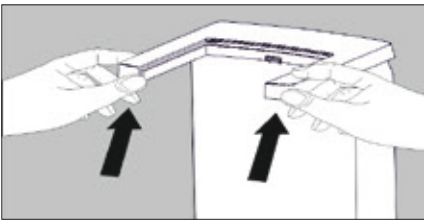

#### 1) Inserting the front panel of the draft shield:

- ▶ Insert the panel on the top into the guide rails of the draft shield.
- ▶ Press the panel gently upwards, while simultaneously pressing downwards into the slot of the draft shield.
- ▶ The panel must click into place in the slot.

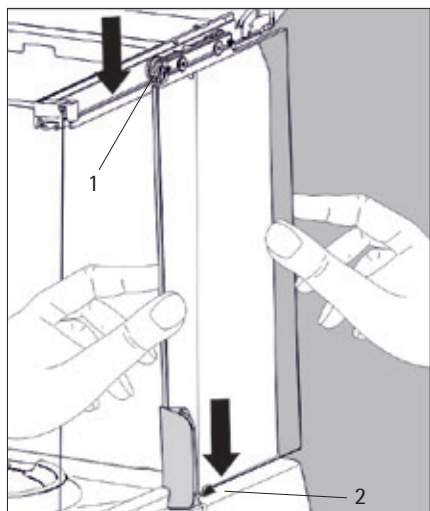

## 2) Inserting the side panels:

- ▶ Mount the guide carriages (1) of the side panel by inserting them into the guide rails on the top.
- ▶ Insert the side panel at the bottom behind the guide rod (2) of the draft shield.
- ▶ Make sure that:
  - the guide carriage (1) is properly and fully positioned on the guide rail.
  - the side panels are positioned behind the guide rod (2).
  - the panels can be moved smoothly and freely.

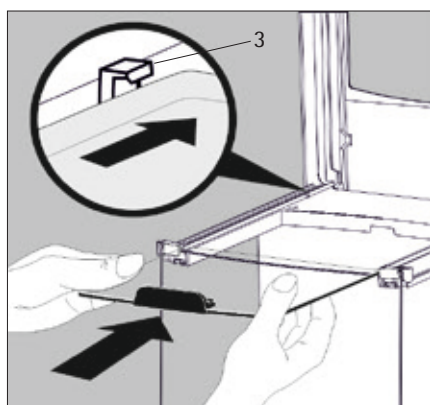

## 3) Inserting the upper panel:

- ▶ Insert the panel on the top of the draft shield guide.
- ▶ Push the panel carefully backwards.
- ▶ Gently lift the panel by its grip in order to push it below the guide rod (3).
- ▶ Close the cover by folding it downwards completely until it locks.

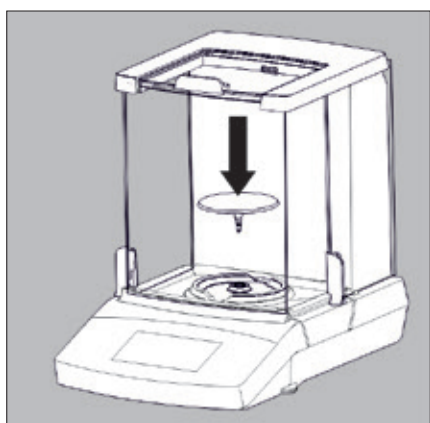

## Inserting the Weighing Pan

- ▶ Insert the weighing pan into the opening of the collection container.
- ▶ Push the upper and side panels forward to close them.

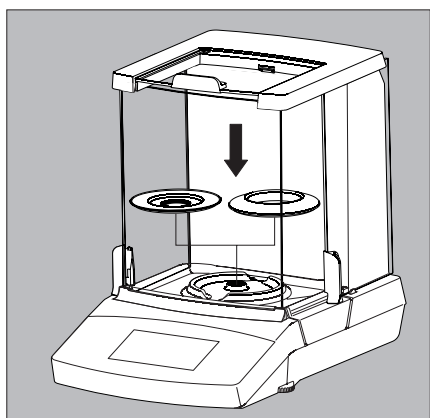

## Secura® 26:

- ▶ Insert the weighing pan into the opening of the collection container.
- ▶ Position one of the two shield disks on the collection container.
- ▶ Push the upper and side panels forward to close them.

### 4.3 Choosing a Location

► **Select the proper setup location:**

- Set up the device on a stable, even surface that is not exposed to vibrations (e.g., a weighing stone).
- Maintain free access to the balance at all times.

Choose a location that is not subject to the following negative influences:

- Heat (heater or direct sunlight)
- Drafts from open windows, AC systems, and doors
- Extreme vibrations during measurement
- Heavy traffic areas (personnel)
- Extreme humidity
- Electromagnetic fields
- Extremely dry air

#### Acclimatization

Condensation from humidity can form on the surfaces of a cold device when it is brought into a substantially warmer area. You should therefore let a device that has been disconnected from its power source acclimatize for approximately 2 hours before reconnecting it to the power.

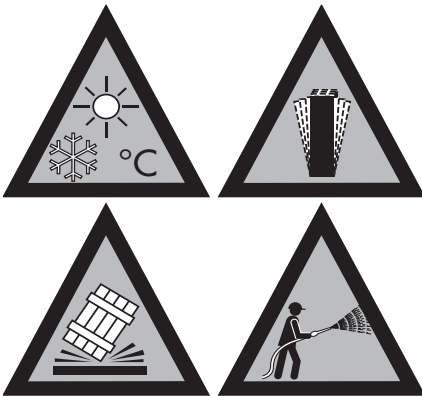

## 4.4 Moving the Balance

### Moving the Balance over Short Distances in the Lab



Avoid glass breakage, shocks and vibrations:  
Never lift or carry the balance by its draft shield!

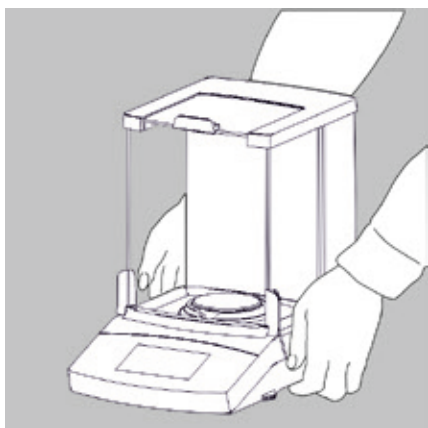

- ▶ Hold the balance under the housing, lift it up carefully, and carry it to its new location.



The balance needs to be re-leveled and then adjusted each time its setup location is changed.





## 4.5 AC Power Supply

### AC Adapter Assembly



**Fatal electric shocks can be caused by use of the incorrect power plug adapter or improper use of the power plug adapter.**

- ▶ Attach the country-specific power plug adapter to the AC adapter. The power plug adapter must be suitable for the wall outlet at the installation location.
- ▶ Do not insert the power plug adapter into the socket without an AC adapter.

Item number on packaging	Power supply/country-specific power plug adapter (packed in PE bag with printed country code, e.g. EU)	Illustration (from left to right)
YEPS01-PS4	Power supply with connection cable	
	China (CN) South Africa (ZA) Australia (AU)	
	India (IN) USA and Japan (US+JP) Europe (EU)	
	United Kingdom (UK)	
	YEPS01-PS5	Power supply with connection cable
	Argentina (AR) Brazil (BR) Korea (KR)	

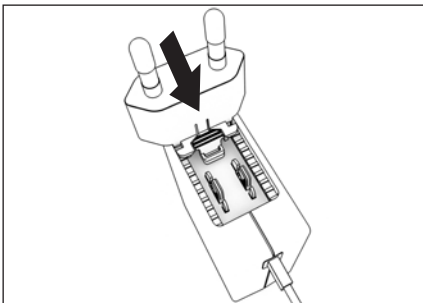

- ▶ Select the country-specific power plug adapter. The power plug adapter must be suitable for the wall outlet at the installation location.
- ▶ Push the power plug adapter into the AC adapter's holder. The ribbed button must be facing forward.
- ▶ Push the power plug adapter all the way in until it audibly engages.
- ▶ Check that the power plug adapter is firmly locked in place. To do this, gently pull on the power plug adapter.
- ▷ If the power plug adapter cannot be moved then it is locked in place.

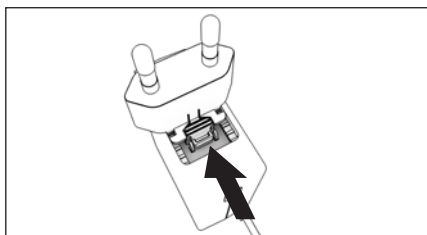

#### Removing the power plug adapter

- ▶ Press on the ribbed button from above while sliding the power plug adapter backward.
- ▶ Push the power plug adapter out of the AC adapter and remove it.

#### Connecting the AC Adapter

- ▶ Check the voltage rating on the AC adapter's type plate. Make sure that the voltage rating printed on this unit matches the local supply voltage at the place of installation.
- ▶ If the stated supply voltage does not comply with the local supply voltage or there is no suitable AC adapter available: Do not use the AC adapter. Contact Sartorius Service.
- ▶ Only use original Sartorius AC adapters.

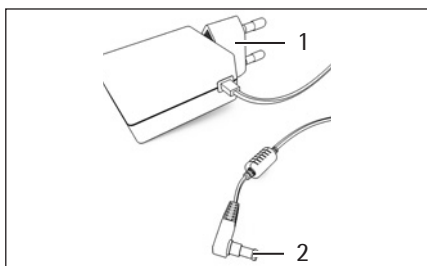

- ▶ Connect the angle plug (2) to the device's power supply socket (operating voltage connection).
- ▶ Connect the power cable (1) to the wall outlet (supply voltage) at the installation location.

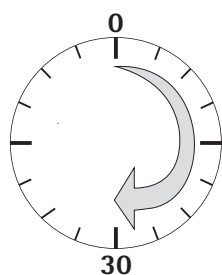

## 4.6 Warm-up Time

- ▶ To ensure accurate results are delivered, the balance must warm up for at least 30 minutes after initial connection to the power supply. Only after this time will the balance have reached the required operating temperature.

**M**

When a verified balance of accuracy class  $\text{E}$  for use in legal metrology is connected to the mains power, it must warm up for at least one hour before operation.

## 4.7 Switching On the Balance





- ▶ Touch  on the display to switch on the balance.
- ▶ When the balance is switched on for the first time or when it has been reset to the factory settings, the startup wizard appears.

### 4.7.1 Startup Wizard

The default language for the display text is English. When the balance is switched on for the first time, the startup wizard is automatically activated. Follow the instructions on the interactive display to configure your selections for:

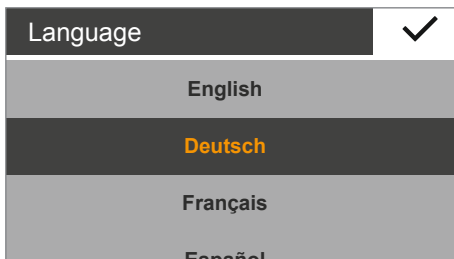
- Language
- Date format/date
- Time format/time



- ▶ The **Language** settings window appears.
- ▶ Touch the language you would like to select, such as **Deutsch**.
- ▶ Touch  to confirm.
- ▶ The display changes immediately to the desired language.

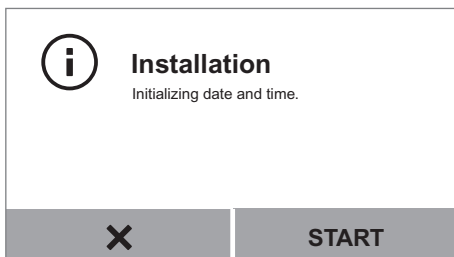

- ▶ The **Getting Started** settings window appears.  
The display format, date, and time can be set here.
- ▶ Touch **START**.

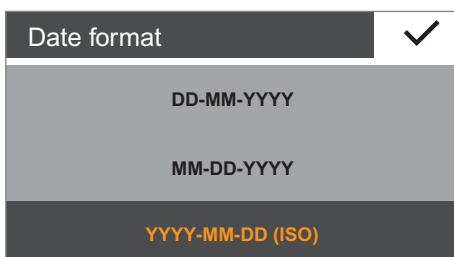

- ▶ The **Date Format** settings window appears:
- ▶ Select how the date should be displayed and printed out.
  - **DD-MMM-YYYY:**  
The date is displayed in the order of day, month and then year.
  - **MMM-DD-YYYY:**  
The date is displayed in the order of month, day and then year.
  - **YYYY-MM-DD (ISO):**  
The date is displayed in the order of year, month and then day.  
(The time is displayed in 24-hour format with this setting.)
- ▶ Touch  to confirm.



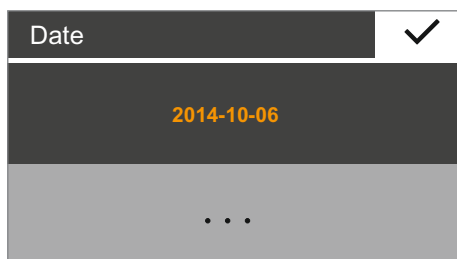

- ▷ The current date is displayed.
- ▶ If the date is displayed correctly, select ✓ to confirm.
- ▶ To adjust the date manually, if required, touch ···, enter the current date and confirm with ✓.

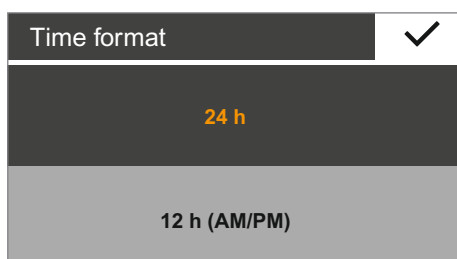

- ▷ The **Time Format** settings window appears:
- ▶ Select how the time is displayed and printed out.
  - **24h:**  
The time is displayed in 24-hour format. (This is the only available setting when the date is set to ISO format.)
  - **12h (AM/PM)**  
The time is displayed in 12-hour format. The hours before noon are displayed with **AM** and the hours after noon are displayed with **PM**.
- ▶ Touch ✓ to confirm.

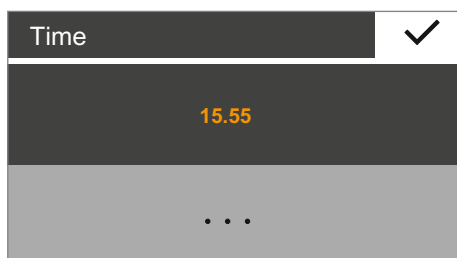

- ▷ The current time is displayed.
- ▶ If the time is displayed correctly, touch ✓ to confirm.
- ▶ To adjust the time manually, if required, touch ···, enter the current time and confirm with ✓.

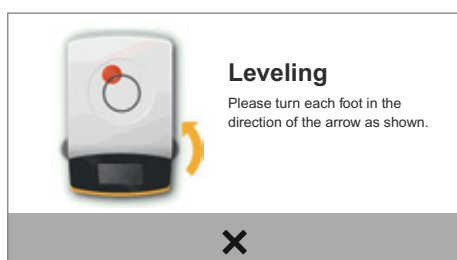

- ▷ The **Leveling** settings window appears:
- ▶ Follow the instructions on the interactive display.

Follow the instructions in Chapter "Leveling the Balance" on page 20.



If required, you can subsequently modify your selection in the "Settings" menu (see Chapter "Accessing the Menu and Changing Settings" on page 27).

## 4.8 Anti-theft Locking Device

- ▶ A “Kensington” key lock can be installed at the fastening point on the back of the balance if required.

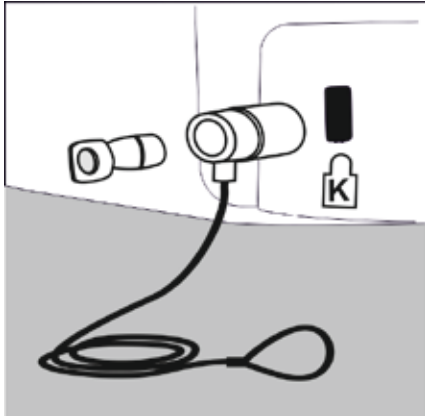

- ▶ The balance can also be secured at the installation location with a chain and lock, for example.

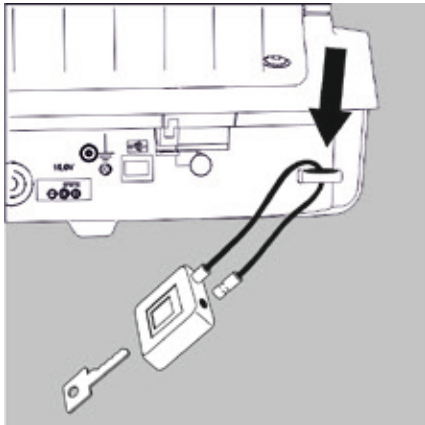

## 5. Using the Balance

### 5.1 Switching the Balance On/Off (Standby)

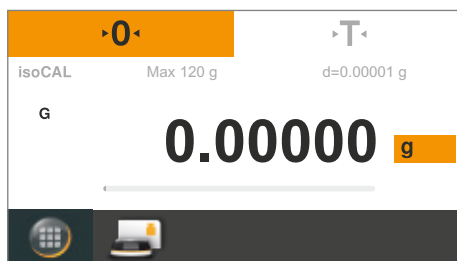

- ▷ The leveling screen is displayed first after any model is switched on. Level the balance if necessary. The actual weighing screen is only displayed after confirmation.
- When the balance is switched on, the following message appears on the display:
  - Secura®: **Level** The balance has been leveled (if leveled).
  - Quintix®: **Level** Please check leveling.
- If the balance needs to be leveled, a message appears on the display (see "Leveling the Balance" on page 20).
- The balance must be regularly calibrated and adjusted in order to achieve accurate weighing results (see "Calibration and Adjustment" on page 72).
- The default language for the display text is English. You can change the language (see "Language" on page 28).



- ▷ To switch the balance to standby, select the menu key at the bottom left of the weighing screen on the display.

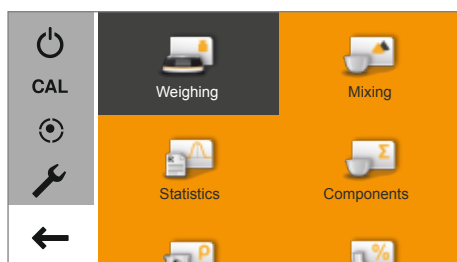

- ▷ The menu is displayed.



- ▷ Select the  button in the application menu.
- ▷ The balance switches to standby mode.



- ▷ To switch the balance on again: Select  on the display. The balance starts in the application most recently used before the it was last switched off.

## 5.2 Leveling the Balance

The balance must be leveled in order to enable it to provide accurate weighing results. Leveling the balance compensates for slant or unevenness at the place of installation by twisting the front leveling feet of the balance.

Leveling is always required if the balance is set up at a different location or is moved at its original location.

The leveling function is different for the various balance models:

- Electronic level indicator (Secura® only)
- Conventional level indicator (Quintix®)



**Note:** The balance needs to be re-leveled and then adjusted each time its setup location is changed.

### 5.2.1 Leveling with Electronic Level Indicator (Secura®)

In Secura® models, the balance's position is checked with sensors. Instructions on the display guide the user when leveling the balance.

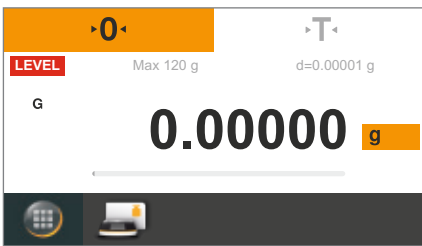

- ▷ When **LEVEL** appears in red at the top left of the display, you must level the balance.

**LEVEL**

- ▶ To start the leveling function, select the **LEVEL** button.

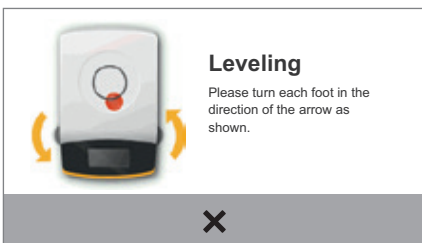

- ▷ The balance position is shown as an animation of a level indicator on the display.
- ▶ Twist the front leveling feet of the balance in the specified direction.



A prompt appears every 2 minutes after confirmation of this "Leveling" status message if the balance has not been leveled.

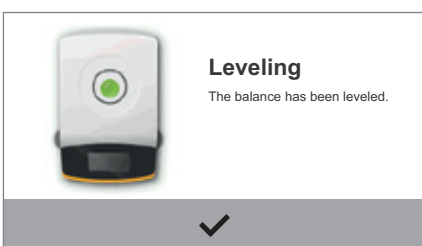

- ▷ When the level indicator animation turns green, the balance is correctly leveled.
- ▶ To exit the function, select ✓.
- ▶ Complete the leveling by calibrating the balance.

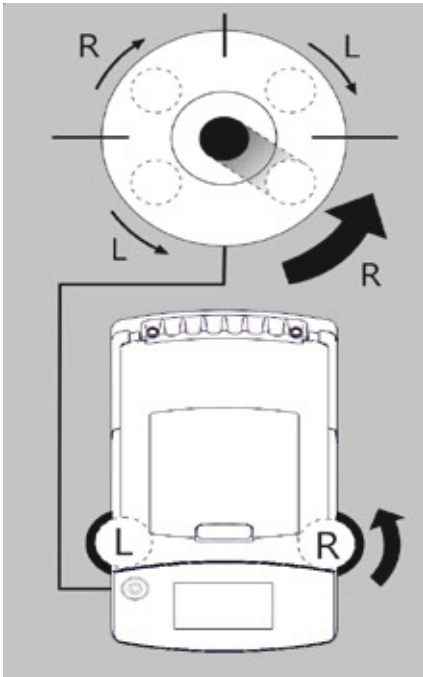

### 5.2.2 Leveling with a Conventional Level Indicator (Quintix®)

The Quintix® models are fitted with a conventional level indicator.

This is located to the left of the display. The position of the air bubble in the indicator shows whether or not the balance is correctly leveled.

- ▶ Twist both of the front leveling feet of the balance to move the air bubble so that it is centered in the circular marking.

The figure shows which leveling foot should be twisted in which direction. Generally, both feet must be adjusted in order to position the air bubble exactly in the center of the circular marking.

Examples:

- If the air bubble is too far to the lower right, twist the right leveling foot counterclockwise (see figure).
- If the air bubble is too far to the upper right, twist the left leveling foot clockwise.
- If the air bubble is too far to the left, twist the left leveling foot counterclockwise and the right leveling foot clockwise.

- ▶ Check the level indicator after each adjustment and correct if necessary.
- ▶ Complete the leveling by calibrating the balance.

## 5.3 Operating Concept

This section explains the operating options available to you so that you can familiarize yourself with the balance.

### 5.3.1 Operating and Display Elements



**Sharp or pointed instruments (such as ballpoint pens) can damage the device!**

– The touchscreen should only be operated by lightly pressing it using the tips of your fingers.

This can be done while wearing laboratory gloves.

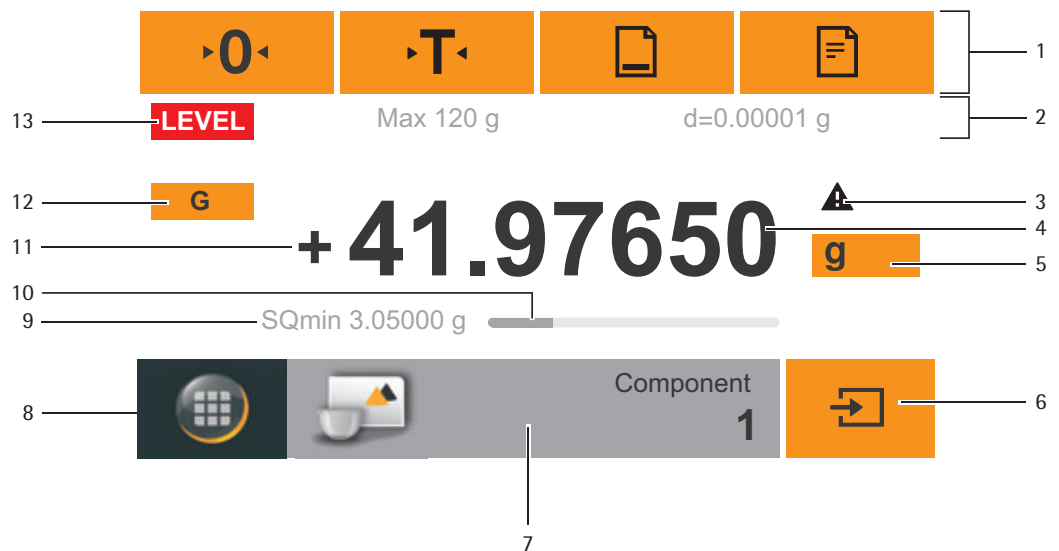

- 1 Toolbar with currently available buttons: Zero, tare, GLP printout, print (data output)
- 2 Metrology line (additional info for minimum capacity Min and the verification scale interval e appear on verified balances)
- 3 Warning symbol to indicate calculated values, negative gross values, or values that are smaller than the minimum sample quantity (SQmin)
- 4 Current weight or value measured
- 5 Unit and stability indicator; set weight unit and display accuracy (see page 41)
- 6 Run application, such as saving the weight value of a component
- 7 Settings for the selected application
- 8 Menu key: Switch to menu or function selection
- 9 SQmin minimum weighing (Secura® only; see page 43)
- 10 Bar graph: Scaled display showing capacity usage (in percent)
- 11 Preceding symbol ( $\pm$ ) for weight value
- 12 Display value ID, e.g., "G" for gross value, "Net" for net value; switch display value for application, such as net value, total value, weight value, or calculated value
- 13 Field for status and warning displays, and activation of isoCAL and leveling

### 5.3.2 Menu

All applications and settings for the balance can be accessed via the menu.



▶ To access the menu, select the menu key at the bottom left of the display.

▷ The menu appears.

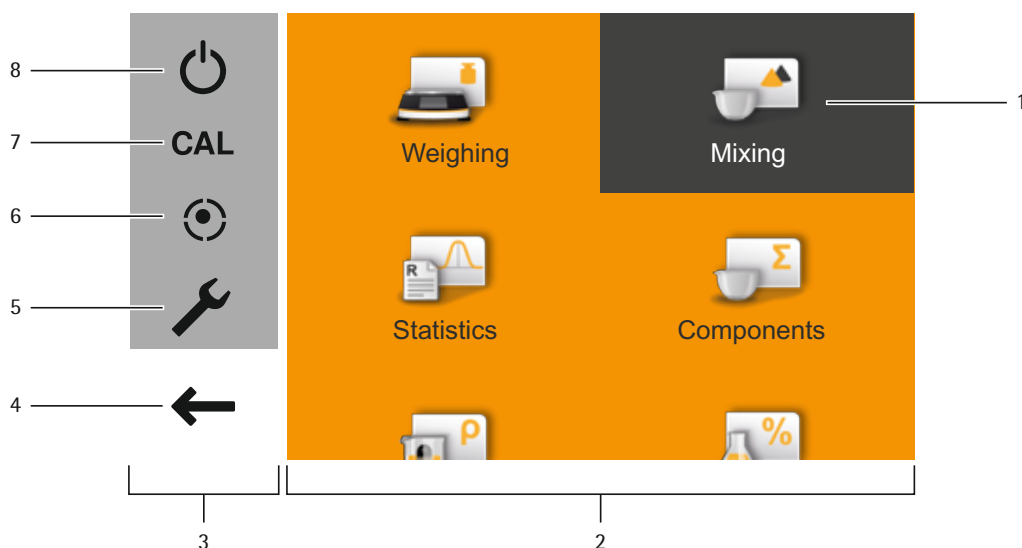

- 1 Selected application (such as **Mixing**)
- 2 Application selection area: Symbols for all available applications (see "List of Applications in the Menu" on page 25)
- 3 Function area
- 4 Back: Run the most recent application.
- 5 Setup menu: Access the balance system settings (see "System Settings (Setup Menu)" on page 27).
- 6 Access the balance leveling function via electronic level indicator (Secura® only – see "Leveling with Electronic Level Indicator (Secura®)" on page 20).
- 7 Access the calibration and adjustment options (see "Calibration and Adjustment" on page 72).
- 8 Switch the balance to standby mode.

Min	+ 0000000 g		✓
1	2	3	←
4	5	6	
7	8	9	C
+/-	0	.	

### 5.3.3 Entering Figures on the Number Pad

Numerical values can be entered for many applications or system settings (such as a minimum value for the **Checkweighing** application). A number pad appears on the display, which is always used in the same way.

- ▶ To enter numbers, select the desired numbers one after the other. The entered numbers appear at the top of the display.
- ▶ To correct the most recent number, select ←. The number is deleted. Then enter the correct number.
- ▶ To delete the entire value, select C.
- ▶ To confirm the entry, select ✓.

### 5.3.4 Entering Text and Characters (Secura® only)

A keyboard will appear whenever you have to enter text or characters. The cursor is located in the line above the keyboard.

- ▶ Select the individual characters simply by touching them.
- ▷ The entered text will appear in the input line.

- ▶ Use the Shift key to switch the keyboard display between uppercase and lowercase letters.

- ▶ Use the 123 key to switch the keyboard display from letters to numbers.

- ▶ Use the ABC key to switch the keyboard display from numbers to letters.

- ▶ Use the backspace key to delete the last character.

- ▶ The ✓ key ends the process and saves the characters entered.

Sample										✓
q	w	e	r	t	y	u	i	o	p	←
a	s	d	f	g	h	j	k	l	/	
↑	z	x	c	v	b	n	m	-	:	
123	↵								←	





### 5.3.5 Accessing an Application in the Menu

The right-hand side of the display shows available applications for various weighing tasks which can be carried out with the balance.

You can scroll up and down through the menu to select the desired application.

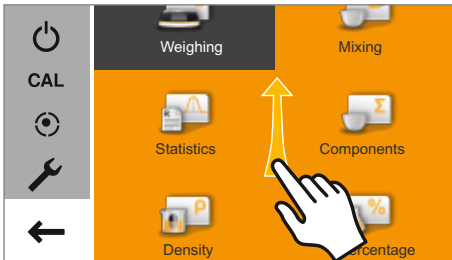

- ▶ To scroll, place your finger on the display and drag it slowly either up or down.
- ▷ The symbols in the menu move in the corresponding direction.

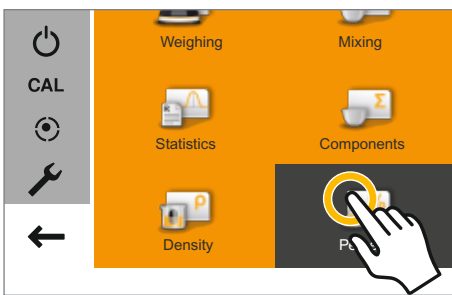

- ▶ Select a symbol to start that particular application.

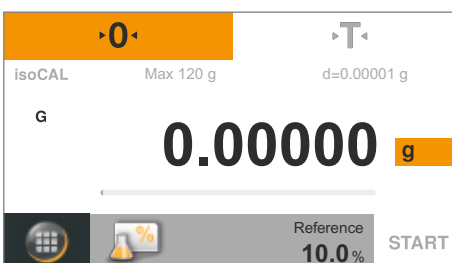

- ▷ The desired application appears on the display.

### 5.3.6 List of Applications in the Menu

The menu provides the following applications for various weighing tasks:



#### **Weighing** (see page 40)

This is the standard application that appears when the balance is first switched on. Use this application to determine the weight of a sample within the device's specific weighing range.



#### **Mixing** (see page 45)

Use this application to weigh up to 99 components one after the other for a mixture or formula in one container. The balance is automatically tared after each component is weighed. The weight value of an individual component or the total weight can be displayed as desired.

**Statistics** (see page 48)

Use this application to save weight and calculated values and statistically analyze them. You can save up to 99 components.

**Components** (see page 51)

Totalize weight values. You can save up to 99 components that are weighed in various individual containers. Each container can be tared before each component is weighed.

**Density** (see page 54)

Use this application to determine the density of solid samples using a density set based on the buoyancy method. The density is determined using Archimedes' Principle. The upward buoyant force exerted on a body immersed in a fluid is equal to the weight of the fluid the body displaces.

**Percentage** (see page 58)

This application is used to determine the percentage share or the percentage difference of the sample related to a reference weight.

**Conversion** (see page 61)

Use this application to multiply the weight value by a user-defined factor. The selected factor is saved to protected memory.

**Unstable condition** (see page 63)

This application is used for moving samples (e.g., live animals) and for weighing in unstable environments. A measurement cycle is automatically carried out with a defined number of measurements for each object to be weighed. The individual measurements are averaged, and this average is displayed as the result.

**Checkweighing** (see page 65)

Use this application to check whether a weight value falls within the specified tolerances. This application also makes it easy to fill sample materials to a specified target weight.

**Peak hold** (see page 67)

Use this application to calculate the maximum weight value of a sample (peak value). The value remains on the display for five seconds after the sample has been removed from the balance.

Example: Use for measuring release force during an experiment, or use when a load is so big that the balance display is hidden from view during weighing.

**Counting** (see page 69)

Use this application to determine the number of parts of approximately equal weight. The weight of a counted reference sample is calculated and then the objects with an unknown piece count are weighed. The balance displays the number of parts and the piece weight.

## 6. System Settings (Setup Menu)

The **Settings** (Setup) menu contains all basic settings for the balance.

# M

On balances verified for use in legal metrology, not all functions and settings are available.

### 6.1 Accessing the Menu and Changing Settings



- ▶ Select the menu key in any application.

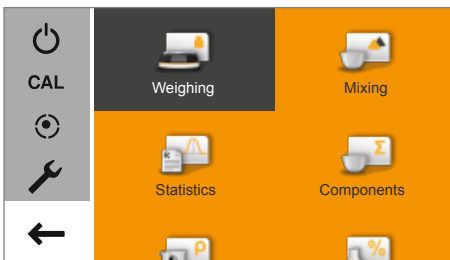

- ▷ The menu appears.



- ▶ To access the system settings of the balance, select (Setup) in the menu.

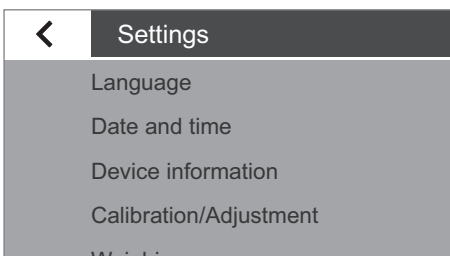

- ▷ The **Settings** (Setup) menu appears.

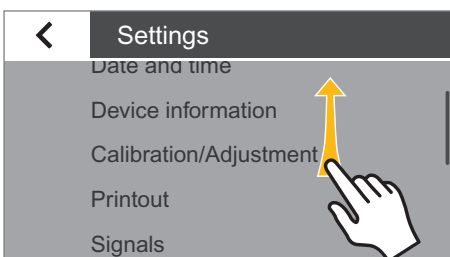

- ▶ To scroll, place your finger on the display and drag it slowly either up or down.
- ▷ The settings in the menu move in the corresponding direction. While you are scrolling, a gray scroll bar appears on the right of the display, indicating where you are in the list of options.
- ▶ Select a setting and make the desired changes. Information about the available settings can be found from page 28.
- ▶ Select  to confirm your changes.
- ▶ Select  to return to the menu. The changed settings are active when you reach the first level of the menu again.

## 6.2 List of Available Settings

This section contains information on all basic balance settings which can be defined in the **Settings** menu.

### 6.2.1 Language

The language of the display text can be set here. English is the default language for the balance.

The following languages are available:

- English
- German
- French
- Spanish
- Italian
- Japanese
- Russian
- Chinese
- Polish
- Portuguese
- Korean
- Turkish
- Hungarian

#### Setting the Language

The default language for the display text is English. To change the language, proceed as follows:

- ▶ Select the menu key at the bottom left of the weighing screen on the display.



- ▷ The menu is displayed.

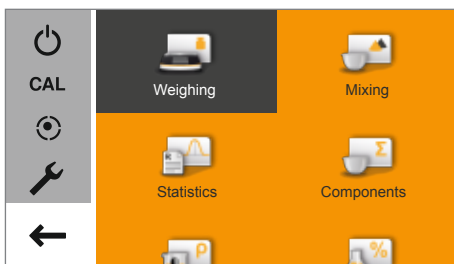

- ▶ Select the  (Setup) key in the menu.



- ▷ The **Settings** window appears.
- ▶ Select **Language** or the top entry in the list.

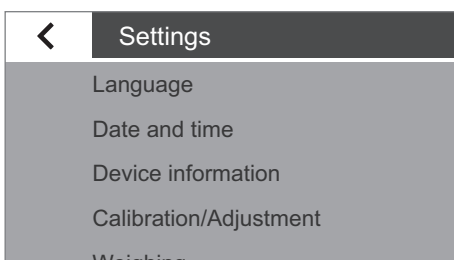

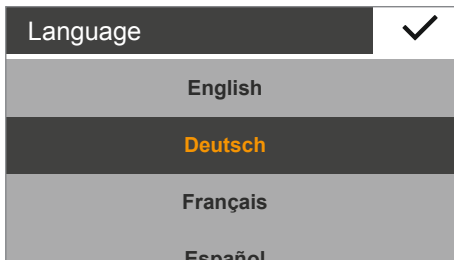

- ▶ The **Language** settings window appears.
- ▶ Touch the language you would like to select, such as **English**.
- ▶ Touch ✓ to confirm.

- ▶ The display changes immediately to the desired language.
- ▶ Select < to return to the menu.

## 6.2.2 Date and Time

The date, time, and display format can be set here.

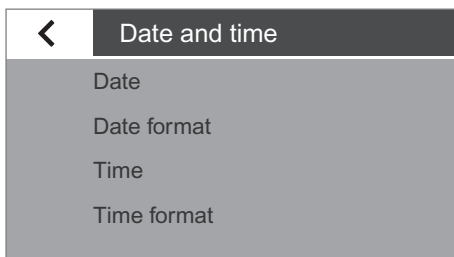

Under **Date**:

- ▶ To set the date, select ···, enter the current date and confirm with ✓.

Under **Date format**:

- ▶ Select how the date should be displayed and printed out.
  - **DD-MMM-YYYY**:  
The date is displayed in the order of day, month and then year.
  - **MMM-DD-YYYY**:  
The date is displayed in the order of month, day and then year.
  - **YYYY-MM-DD (ISO)**:  
The date is displayed in the order of year, month and then day.  
(The time is displayed in 24-hour format with this setting.)

Under **Time**:

- ▶ To set the time, select ···, enter the current time and confirm with ✓.

Under **Time format**:

- ▶ Select how the time is displayed and printed out.
  - **24h**:  
The time is displayed in 24-hour format. (This is the only available setting when the date is set to ISO format.)
  - **12h (AM/PM)**:  
The time is displayed in 12-hour format. The hours before noon are displayed with **AM** and the hours after noon are displayed with **PM**.

### 6.2.3 Device Information

The manufacturer, model, serial number and software version of the balance are displayed here.

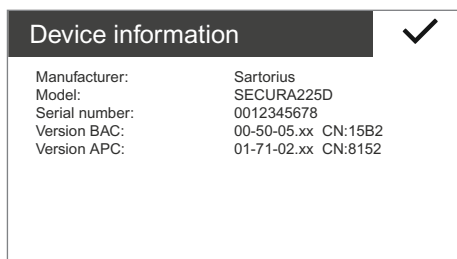

### 6.2.4 Calibration/Adjustment

You can configure how the automatic calibration/adjustment function isoCAL starts. You can view the saved reports on recently conducted adjustments, including the deviations detected, and send the output to a PC or a Sartorius laboratory printer.

Under **isoCAL**:

- ▶ Select the desired start option for isoCAL.
  - **Off**: isoCAL is switched off.
  - **Info, manual start**: A note appears on the display when predefined time intervals or temperature values are exceeded. isoCAL can be started manually.
  - **Automatic**: isoCAL is switched on. Calibration/adjustment starts automatically when predefined time intervals or temperature values are exceeded.

Under **Calibration report**:

- ▶ Select the desired report by date. If there is more than one calibration report per date, use the < and > buttons to navigate through the reports.
- ▶ Select to print the displayed report.

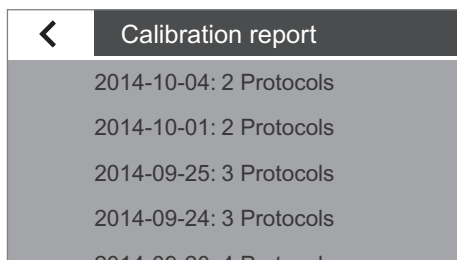
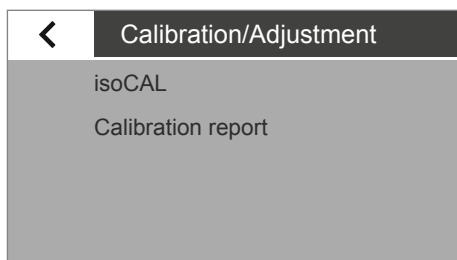

Up to 99 entries per day are saved. Calibration reports older than 30 days are deleted.

### 6.2.5 Weighing

A number of basic settings for the weighing functions can be defined here. Options are limited for verified balances. All settings given in the menu are permitted.

Under **SQmin** (Secura® only):

If the SQmin function is set up on the balance, the function can be switched **On** or **Off** here (see "SQmin Minimum Weighing (Secura® only)" on page 43).

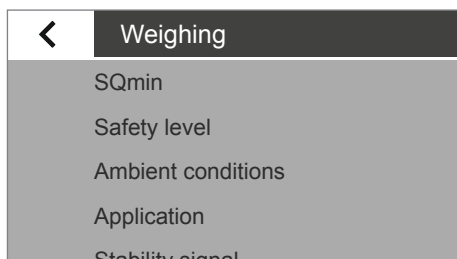

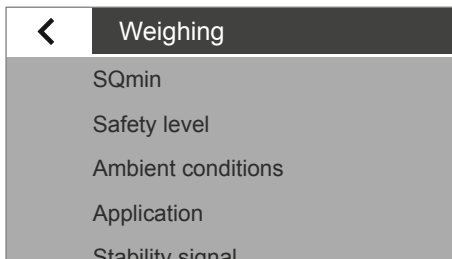

### Safety Level

The Secura® models monitor the following at all times:

- whether the balance is leveled correctly
- whether adjustment is necessary
- whether minimum sample quantity requirements are met according to USP

Under **Safety level** (Secura® only):

- ▶ Select the desired safety level for **SQmin**, **isoCAL** and **LEVEL**.

## M

If a verified balance has not been leveled, the following functions will be disabled immediately (as is the case with the "High" safety level):

- Printout
- Startup and saving of application

Here, it does not matter what settings this menu item has.

**High** (factory setting): If one of the three conditions has not been met, a warning is displayed straight away. No data is transmitted.

The following functions are disabled immediately:

- Printout
- Startup and saving in applications

Displays:

- Information about red marking of display element (LEVEL, isoCAL or SQmin)
- Weight value displayed in gray with a black warning symbol

A warning is displayed after 60 seconds if no action is taken to correct the problem.

**Standard:** If one of the three conditions has not been met, a warning is displayed straight away.

Displays:

- Information about red marking of display element (LEVEL, isoCAL or SQmin)
- Weight value displayed in gray with a black warning symbol

A warning is displayed after 60 seconds if no action is taken to correct the problem.

Printout:

- Weight values are marked with "!"

**Low:** The following information is displayed:

- SQmin value has not been achieved -> SQmin value is displayed in red
- Balance not leveled -> Red marking on "LEVEL" display element
- Balance not adjusted due to temperature or time -> Red marking on "isoCAL" display element

Under **Ambient conditions**:

- ▶ Choose whether the conditions at the balance location are **Stable** or **Unstable**. If **Unstable** is selected, adverse ambient conditions (drafts, vibrations) are filtered by changing the measurement time for the weight values.

Under **Application**:

- ▶ Choose whether the balance will be used for **Weighing** or **Dosing**. This setting is used to compensate for load fluctuations on the display.
  - **Weighing**: The display responds very quickly to fast load changes. The display responds more slowly to small changes in weight (in the digit range). This setting is suitable for normal weighing.
  - **Dosing**: The display responds quickly to small changes in weight, making it faster and more accurate for additional dosing and container filling functions.

Under **Stability signal**:

- ▶ Choose whether stability is shown with **High accuracy**, **Medium accuracy** or **Fast** on the display. The balance stability is displayed as soon as the weighing result is constant within a defined range. Until stability is reached, the measured value is shown in gray on the display and only turns black once the balance is deemed stable.

Under **Zero/tare**:

- ▶ Define settings for zeroing and taring.
  - **Zero/Tare function**: Choose whether the balance is zeroed and tared **With stability** or **Without stability**. If **Without stability** is selected, the balance will automatically be tared when **•O•** or **•T•** is selected. If **With stability** is selected, the balance is tared the next time stability is reached after **•O•** or **•T•** is selected.
  - **Automatic zero (zero tracking function)**: If this option is enabled, changes of a set fraction of scale intervals per second starting from the display zero point are automatically zeroed.
  - **Zero/Tare at power on**: If this option is enabled, the balance is automatically zeroed or tared when switched on.



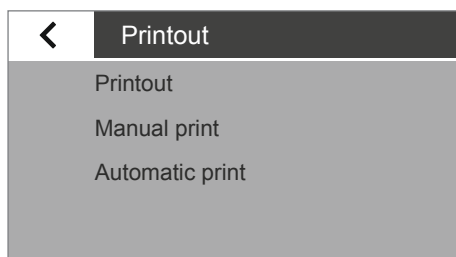

## 6.2.6 Printout

You can configure the settings for printing and data output here. Some of the settings depend on the USB port configuration (see "USB Port" on page 35).

### Under **Printout**:

- ▶ Define the settings for outputting logs and reports to a connected lab printer.
  - **Manual**: The data is printed out when  is selected in the application.
  - **Automatic**: The data is printed out automatically.
  - **Without stability**: No stability is required for a printout. The printout does not have any unit symbols in this case.
  - **With stability**: The data can only be printed out when stability is reached.
  - **Print after weight change**: Data is printed once, after a threshold has been exceeded at stability and the weight has previously been reduced to less than half of the threshold.

### Under **Manual print**:

This option can be selected when manual print has been set in the **Printout** menu option.

- ▶ Define the settings for the manual print.
  - **ISO/GLP printout**: Activate this option when an ISO/GLP-compliant printout is required.
  - **Tare after print**: Activate this option to automatically tare the balance after printing.
  - **Manual print format**: Select the information to be printed during manual printing, such as date and value.
    - Value without ID**: Only if being transmitted to a PC (menu items: USB port: **Device/protocol: PC – xxx**)
    - Value** or **date, value** or **value (N, T, G#)** or **date, value (N, T, G#)**

### Under **Automatic print**:

This option can be selected when automatic print has been set in the **Printout** menu option.

- ▶ Define the settings for the automatic print.
  - **Autom. print interval**:
  - **Interval time**:
    - Choose from the last three interval times or enter the desired interval time in seconds via  $\cdot\cdot\cdot$  and confirm with  (factory setting: 5 seconds).
  - Select the **Standard** option to use model-specific output rate for weight determination.
  - **Autom. print format**: Select the information to be printed during automatic printing, such as date and value.
    - Value without ID**: Only if being transmitted to a PC (menu items: USB port: **Device/protocol: PC – xxx**)
    - Value** or **date, value**

## 6.2.7 Identifier (Secura® only)

Define identifiers for the printout via the  button and in the ISO/GLP printout here. Under **Printout** in **Manual print**, the **ISO/GLP printout** option must be activated. IDs can be maximum 14 characters long.

### Under **Set device ID:**

The device identifier (ID) is printed in the header of the GLP printout.

- ▶ To activate the device ID, select ···, enter the desired device ID, and confirm with ✓.

### Under **Set additional ID:**

The additional ID (A ID) is also printed in the header of the GLP printout.

- ▶ To activate the additional ID, select ···, enter the desired device ID and confirm with ✓.

### Under **Batch ID function:**

The batch ID (L ID) is queried one time at the start of the GLP printout.

- ▶ Activate this option to enter or print out the batch ID.

### Under **Sample ID function:**

The sample identifier (S ID) can be activated for each printout by selecting the  button.

- ▶ Define settings for printing the sample ID.
  - **On:** The sample ID is activated. This ID is queried before each printout.
  - **Autom. increment:** Select this option to automatically assign the sample ID in ascending order.
  - **Autom. decrement:** Select this option to automatically assign the sample ID in descending order.
  - **Off:** The sample ID is deactivated.



To enter and delete numbers and text, e.g., for the sample ID, see "Entering Figures on the Number Pad" on page 24.

## 6.2.8 USB Port

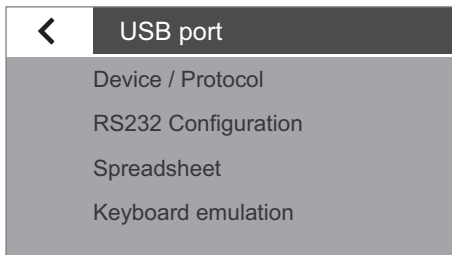

The settings for the data transfer to a peripheral device (such as a PC or printer) can be defined here.

# M

In legal metrology data can be transmitted to a PC and used with an Alibi memory. The balance does not have its own Alibi memory. Connection to a printer or Alibi printer is permitted.

Depending on the cable and peripheral device connected to the balance, various options are available in the menu. The balance automatically detects the type of connection.

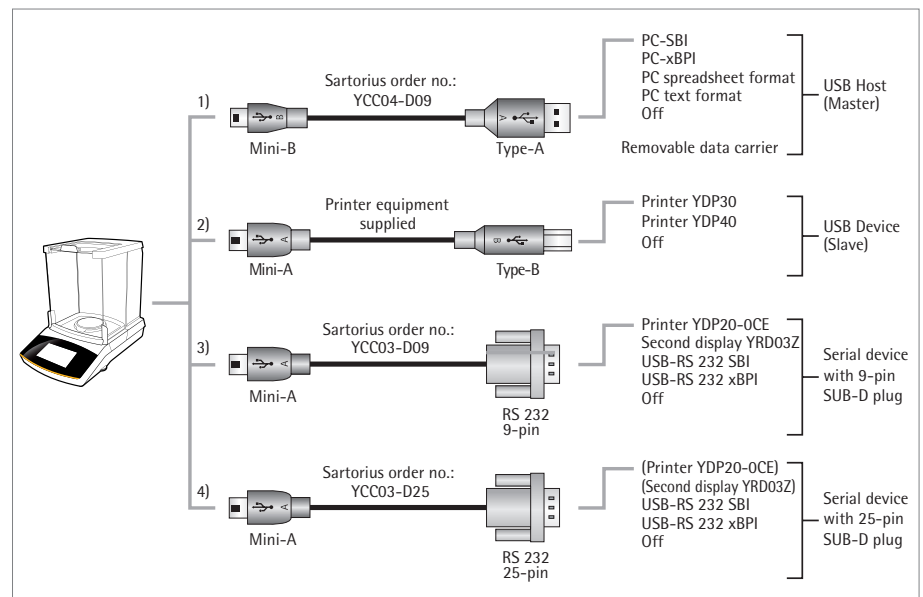

There are several ways to connect the balance via USB:

### 1) Connection to a PC via USB Cable (Mini-B to USB A)

Under **Device/Protocol**:

- ▶ Select the data format for the transfer to the PC.
  - **PC - SBI**: Driver for PC required (CDC Virtual Com Port). The data is sent via SBI protocol using a virtual serial interface. Information on the driver and SBI can be found from page 82.
  - **PC - xBPI**: Driver for PC required (CDC Virtual Com Port). The data is sent via xBPI protocol using a virtual serial interface. Information on the driver and xBPI can be found from page 82.
  - **PC spreadsheet format**: The balance transmits the data via keyboard command (keyboard emulation) to the currently opened application on the PC in spreadsheet format.
  - **PC text format**: The balance transmits the data via keyboard command (keyboard emulation) to the currently opened application on the PC in text format.
  - **Off**: Data transmission is deactivated.

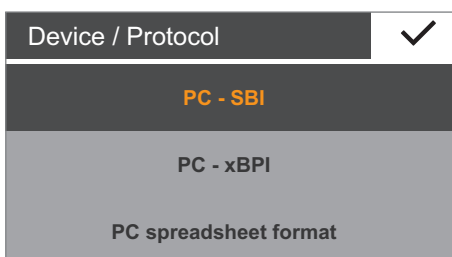

Additional menu option if "PC spreadsheet format" has been selected:

Under **Spreadsheet**:

- **Decimal markers:**
  - **Decimal point** (factory setting): The number value is transmitted with a decimal point to the PC program (example: 99.963 g).
  - **Decimal comma:** The value is transmitted with a decimal comma to the PC program (example: 99,963 g).

Additional menu option if "PC spreadsheet format" has been selected:

Under **Spreadsheet**:

- **Output format:**
  - **Text and numerical value** (factory setting):  
Transmits the output with ID, value and unit, across several lines if necessary.
  - **Numerical value only:** Outputs numerical value only, in one line (without ID and unit) (date, value or net/tare/gross).

Additional menu option if "PC spreadsheet format" or "PC text format" has been selected:

Under **Keyboard emulation**:

- **Universal (Num Lock On)** (factory setting): Data is sent as special keyboard characters in ASCII format (ALT + number pad).  
Requirement: Numbers lock must be turned on on the PC keyboard.
- **English (USA):** Data is sent according to a keyboard set to English (USA).  
Requirement: For PC applications, such as MS Excel, the keyboard must be set to English (USA).



You can find more information in Chapter "USB Port" on page 78.

---

## 2) Connection to Sartorius Lab Printer via the Supplied Printer Cable

Under **Device/Protocol**:

- ▶ Select the desired setting for the connection to the printer.
  - **YDP30/YDP40**: The connected printer is detected automatically and the connection is established.
  - **Off**: The connection to the printer is deactivated.

## 3) and 4) Connection to a Serial Printer or Another External Serial Device via a 9/25-pin Serial Interface (USB Mini-A to RS-232)

Under **Device/Protocol**:

- ▶ Select the desired setting for the connection to the device.
  - **Printer YDP20-OCE**
  - **Remote display YRD03Z**
  - **USB-RS-232 SBI**
  - **USB-RS-232 xBPI**
  - **Off**: The connection is deactivated.

Under **RS-232 Configuration**:

This option can be selected if under **Device/Protocol** the setting **USB-RS-232 SBI** has been selected.

- ▶ Select the desired setting for the RS-232 interface.
  - **Baudrate**: 600 to 19,200 (factory setting: 9600)
  - **Databits**: 7 bits or 8 bits (factory setting: 8 bits)
  - **Parity**: Odd, even, or none (factory setting: odd)
  - **Stopbits**: 1 bit or 2 bits (factory setting: 1 bit)
  - **Handshake**: Software (XON, XOFF), hardware (CTS, RTS), or off [factory setting: hardware (CTS, RTS)]

### 6.2.9 Display Brightness

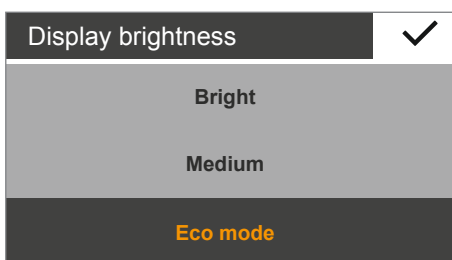

The brightness of the display can be set here.

The following brightness levels are available:

- **Bright**
- **Medium**
- **Eco mode**: Energy-saving mode (factory setting): The brightness is reduced after 2 min. of inactivity. To reactivate the normal brightness: Touch any key.

### 6.2.10 Acoustic Signal

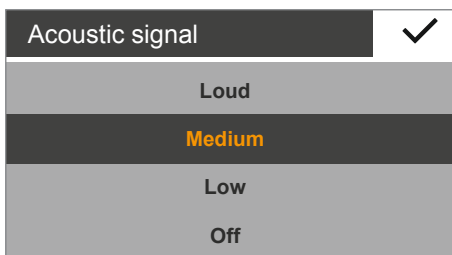

The volume of the acoustic signal can be set here.

The following volume levels are available:

- **Loud**
- **Medium**
- **Low**
- **Off**

### 6.2.11 More Settings

Additional service functions for the balance can be found here.

Under **Set password** (Secura® only):

Secura® models can be password-protected to prevent unauthorized personnel from making changes to the system settings of the balance.

When a user password is set, all settings which could change the metrological behavior of the balance are locked.

- ▶ Select **...**.
- ▶ Enter a number as the password.
  - If you have made a mistake, you can correct your entry:
    - **←** button: Delete individual characters in reverse order.
    - **C** button: Delete all characters.
- ▶ Enter the same password again to ensure correct entry.
- ▶ Confirm with **✓**.
- ▷ The new password is only active once you have returned to the first level of the menu.

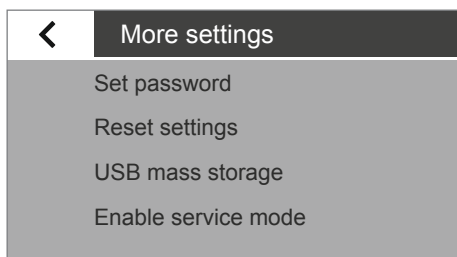

To change the password, the old password must first be entered.

A new password can then be set.

To completely delete the password and use the balance without password protection, leave the entry blank.

Contact the Sartorius Service Center if you forget the password.

Under **Reset settings**:

Reset all balance settings to the factory (default) settings here.

- ▶ When the security prompt appears, select **Yes, reset** and confirm with **✓**. The balance is reset and restarts.

Under **USB mass storage**:

Use this function to register the balance memory as a USB removable data carrier on a PC. This function is required by the Sartorius Service Center or when installing the PC driver for the virtual COM port.

Further information can be found in Chapter "USB Port" on page 78.

Under **Enable service mode**:

This function is used by the Sartorius Service Center and can only be accessed by authorized service technicians. The following service functions are available:

- Preset value for minimum weighing (SQmin)
- Enter date for next service
- Reset all settings to factory settings

The **Calibration/Adjustment** menu also provides the following functions for authorized Service Center personnel (depending on the model):

- External linearization (not for use in legal metrology)
- Set the preload
- Delete the preload
- Internal linearization (not for use in legal metrology)



These functions are not available for verified and sealed balances.

**Locking the Menu** (Quintix® models)

Use this function to lock or unlock the menu.

- ▶ Hold down the Menu key for longer than 10 seconds.
- ▶ Confirm with "Lock."

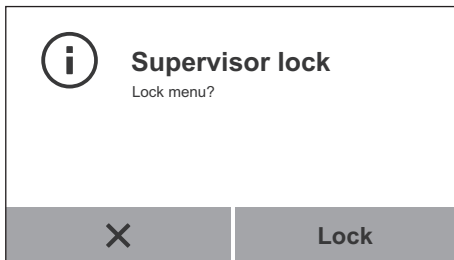

Accessing the menu or unlocking it again:

- ▶ Hold down the Menu key for longer than 10 seconds.
- ▶ Then select the required function.

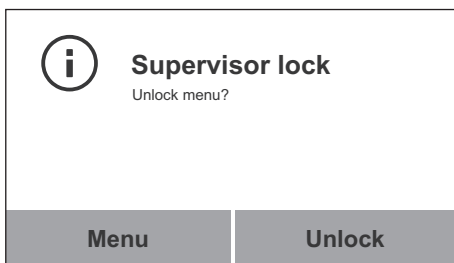

## 7. Weighing

**Purpose:** Use this application to determine the weight of a sample within the device's specific weighing range (see Specifications).



▶ Select the menu key in any application.



▶ Select the **Weighing** symbol in the menu.

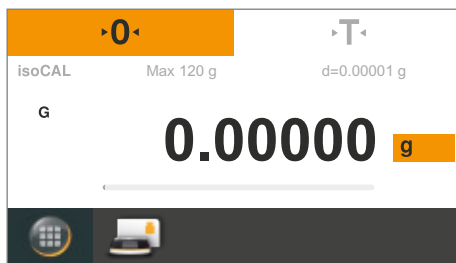

▷ The **Weighing** application appears.

### Zeroing

▶ Remove the load from the balance.

▶ Select **0** to zero the balance.

All weight values are measured based on this zero point (zeroing within  $\pm 2\%$  of the weighing range around the zero point).



### Taring

▶ Place an empty container on the balance, if weighing with containers.

▶ Select **T** to tare the balance.

The balance displays zero again after being tared.

The tared value is subtracted from the overall weighing range of the balance.

The balance can be tared throughout its entire weighing range.



▶ Place the sample on the weighing pan.

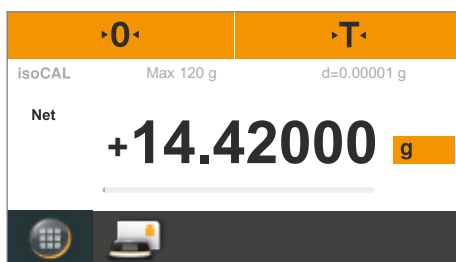

▷ You can read the measured value as soon as the weight value stops changing and the unit is displayed.

The balance stability is displayed as soon as the weighing result is constant within a defined range. Until stability is reached, the measured value is shown in gray on the display and only turns black once the balance is deemed stable.



## 7.1 Mass Unit Conversion

Purpose: Configure the weight unit and accuracy of the weight value displayed.

# M

Not all units can be selected on balances used for legal metrology. The user can only switch between metric units (e.g., milligram, gram, kilogram).

Unit / Accuracy ✓	
g	All digits on
kg	Last digit autom. off
ct	Last digit off
lb	Reduced by 2 digits

▶ To switch to another unit, select the Unit button on the weighing display.

▷ The **Unit/Accuracy** menu appears.

The left list contains the available units. The currently selected unit is marked (e. g., **g**). The most recently selected units automatically appear at the top of the list. Units which are rarely or never used are shown further down the list. The right list contains the display accuracy options. The currently selected setting is marked (e. g., **All digits on**).

▶ Select the unit to be used to display the weighing results (e.g., **g, kg, ct**).

▶ Select the display accuracy (e.g., **All digits on** or **Last digit off**). The display accuracy can be individually assigned to each unit.

▶ Touch ✓ to confirm.

▷ The weighing display appears with the changed settings. This setting remains until the selection is changed.



There is an online animation for this application. Click here to view it:



### Conversion Factors for Weight Units

The table contains common weight units and their conversion factors in relation to the gram. The balance can work in the following units as and when needed (with verified balances, this is only possible if the country's laws regarding legal metrology and verification permit this):

Unit	Factor	Display
Gram	1.000000000000	g
Kilogram	0.001000000000	kg
Carat	5.000000000000	ct
Pound	0.00220462260	lb
Ounce	0.03527396200	oz
Troy ounces	0.03215074700	ozt
Hong Kong tael	0.02671725000	tlh
Singapore tael	0.02645544638	tls
Taiwanese tael	0.02666666000	tlt
Grain	15.43235835000	GN
Pennyweight	0.64301493100	dwt
Milligram	1000.000000000000	mg
Parts per pound	1.12876677120	/lb
Chinese tael	0.02645547175	tlc
Momme	0.2666666666666667	mom
Austrian carat	5.000000000000	Kt
Tola	0.08573333810	tol
Baht	0.06578947437	bat
Mesghal	0.21700000000	MS
Newton	0.00980665000	N

**M**

Some weight units and accuracy settings may be blocked from use in verified balances, depending on national laws regarding legal metrology and verification.



Depending on the country-specific model version, not all weight units listed may be available.

## 7.2 SQmin Minimum Weighing (Secura® only)

**Purpose:** This application is used to compare the measured weight value directly with the defined minimum sample quantity (SQmin = sample quantity minimum). This ensures that weighing results are above the specified minimum weight defined by your quality assurance system. This function is used to observe the minimum weight in order to meet the criteria of the United States Pharmacopeia (USP), for example.

### M

SQmin is not the same as the minimum capacity Min in legal metrology.

**Requirements:** The balance must be set up by a service technician to be able to use the SQmin function. The technician will determine the permitted minimum sample quantity and load this to your balance using the guidelines of your QA system. He or she will document this setting via a "Weighing module test as per USP" certificate in which the measurements and min. sample quantity are logged. The SQmin function ensures that the weighing results correspond to USP guidelines.

#### Switching SQmin On/Off

If the SQmin function is set up on the balance, go to the **Settings** menu, **Weighing – SQmin** to switch it on/off.

#### Display of SQmin Function during Weighing

- ▶ Place the sample on the weighing pan.
- ▷ The SQmin value is displayed in red if the weight value is smaller than the specified minimum weight. The weight value is displayed in gray if it is smaller than the specified SQmin value. The weight value cannot be saved or printed out in applications (depending on the setting in the "Safety level" menu).

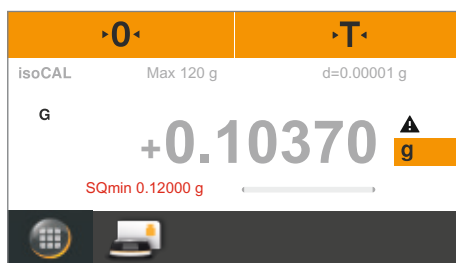

### 7.3 Individual Identifiers (Secura® only)

- Purpose: You can define identifiers for the following print jobs:
- Device identification (ID): printed in header of GLP printout.
  - Additional ID (A ID): printed in header of GLP printout.
  - Batch ID (L ID): queried after each GLP head in GLP printout at beginning of measurement.
  - Sample ID (S ID): for printouts via the  button. This ID is queried before each printout.

- Requirements:
- The balance must be connected to a Sartorius lab printer or PC for printouts (see page 78).
  - The settings for individual identifiers can be configured in the system settings under **Identifier** (see page 34).
  - The GLP printout can be activated in the system settings under **Printout** in **Manual print** (see page 33).

#### Starting the Printout

Example: Configuration of system settings for printing sample ID (S ID):  
**Identifier – Sample ID function – Autom. increment**



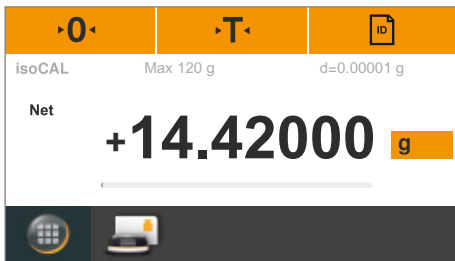

- ▶ Place the sample on the weighing pan.

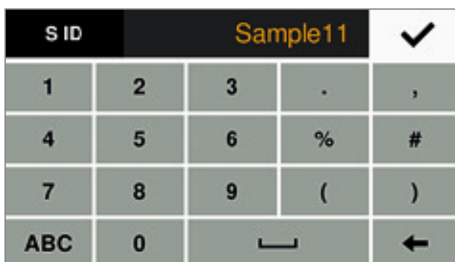

- ▶ Select  to print.



- ▶ The identifier for the printout is displayed. The displayed value can be changed if desired.
  - Delete the last character: Select .
- ▶ Touch  to confirm.

- ▶ The weight value is displayed. A sample printout can be seen below:

```

-----
S ID           Sample 11
N           +100.21000 g
S ID           Sample 12
N           +100.19000 g
    
```

## 7.4 Mixing

**Purpose:** Use this application to weigh up to 99 components one after the other for a mixture or formula in one container. The balance is automatically tared after each component is weighed. The weight value of an individual component or the total weight can be displayed as desired.

**Example:** You want to weigh several components of a formula in one container.



▶ Select the menu key in any application.



▶ Select the **Mixing** symbol in the menu.

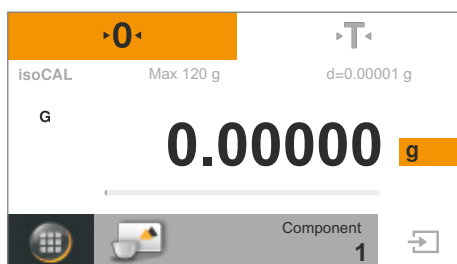

▶ The **Mixing** application appears.

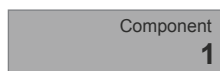

▶ To change the settings, select the gray button.

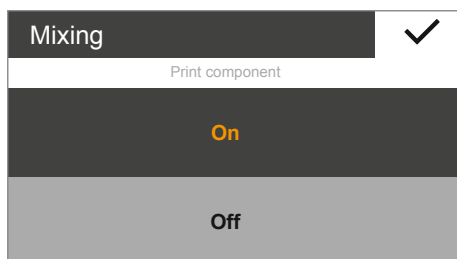

▶ The **Mixing** settings window appears.

▶ Choose whether the individual weights of the components are printed out when a printer is connected.

▶ Touch ✓ to confirm.



▶ Select **0** to zero the balance if necessary.



▶ Place a container on the weighing pan.



▶ Select **T** to tare the balance.

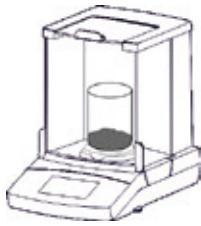

- ▶ Place the first component on the weighing pan.

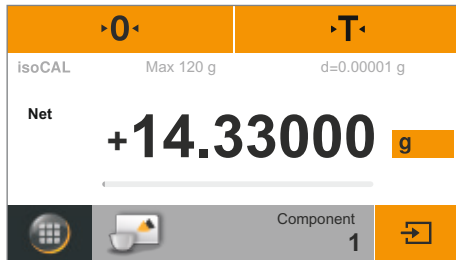

- ▷ The weight value is displayed.



- ▶ To save the component, select .

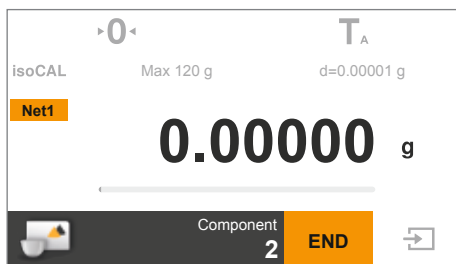

- ▷ The component is saved, and the balance is automatically tared.

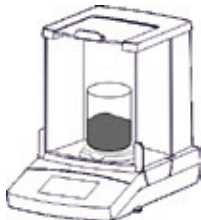

- ▶ Place the next component on the weighing pan.



- ▶ To save the component, select .

- ▶ Continue this procedure with additional formula components.

**Net1**

- ▶ To view the total weight, select the **Net1/Total** button on the weighing display.

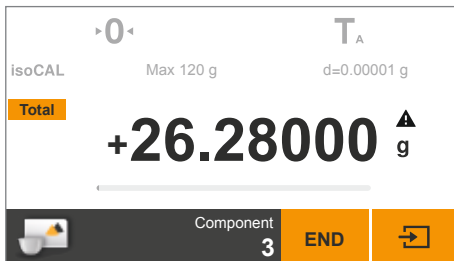

- ▶ The total weight is displayed.

**Total**

- ▶ To change back to viewing the individual weights of each component, select the **Net1/Total** button again.

**END**

- ▶ To exit the function, select **END**.
- ▶ The total weight is displayed and the application switches back to its original state.

**Printing Results**

Requirements:

For printouts, a printer (e.g., Sartorius YDP40) or PC must be connected and configured (see page 78).

In the **Mixing** settings window the **Print component** option must be set to **On**.

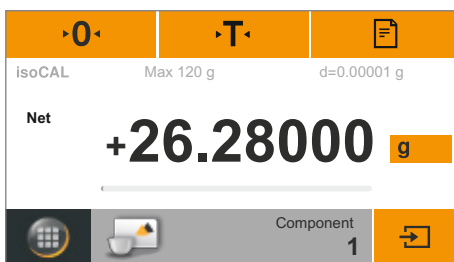

- ▶ If a printer is connected, an additional button automatically appears at the top right of the display.



- ▶ When each component is saved, their weight value is printed (**Comp 1**, **Comp 2**, etc.)
- ▶ Select **END** to print the total weight (**T-Comp**).
- ▶ A sample of the complete printout is given below:

```
-----
Comp1 + 14.33000 g
Comp2 +  5.97000 g
Comp3 +  5.98000 g
T-Comp+ 26.28000 g
```



There is an online animation for this application. Click here to view it:



## 7.5 Statistics

**Purpose:** Save weight values and statistically evaluate them. You can save up to 99 components.

The values are generated as results:

- Number of components
- Average
- Standard deviation
- Variation coefficient
- Sum of all values
- Lowest value (minimum)
- Highest value (maximum)
- Spread: Difference between maximum and minimum

**Requirements:** For printouts, a printer must be connected and configured (see page 78).



▶ Select the menu key in any application.



▶ Select the **Statistics** symbol in the menu.

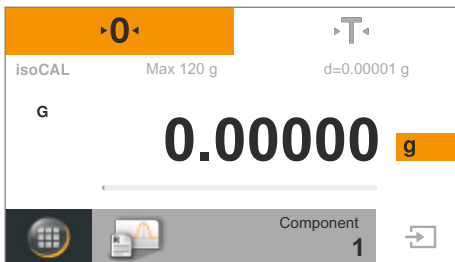

▷ The **Statistics** application appears.

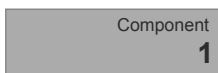

▶ To change the settings, select the gray button.

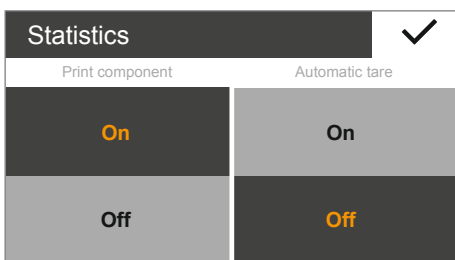

▷ The **Statistics** settings window appears.

- ▶ Choose whether the individual weights of the components are printed out.
- ▶ Determine whether the balance is tared when a component is saved.
- ▶ Touch ✓ to confirm.



▶ Select **0** to zero the balance if necessary.

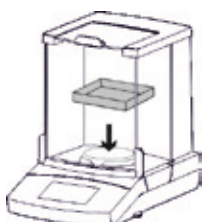

▶ Place a container on the weighing pan.





- ▶ Select **T** to tare the balance.



- ▶ Place the first component on the weighing pan.

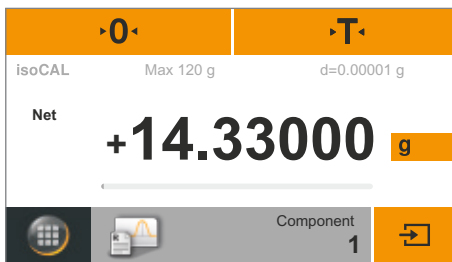

- ▶ The weight value is displayed.



- ▶ To save the component, select .

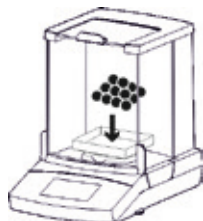

- ▶ Remove the first component from the weighing pan and place the next component on the balance.



- ▶ To save the component, select .

- ▶ Continue this procedure with additional components.
- ▶ The weight values of the saved components (**Comp1**, **Comp2**, etc.) are printed on the connected printer.

A sample printout can be seen below:

```
-----
Comp1 + 14.33000 g
Comp2 +  8.47000 g
Comp3 + 18.30000 g
Comp4 + 13.19000 g
Comp5 + 13.18000 g
```



- ▶ To display the intermediate result for previously saved components, select .

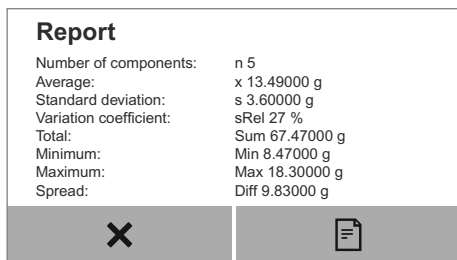

- ▶ The following values are displayed as an intermediate result:
  - Number of saved components
  - Average
  - Standard deviation
  - Variation coefficient
  - Sum of all values
  - Lowest value (minimum)
  - Highest value (maximum)
  - Spread: Difference between maximum and minimum



- ▶ To print the intermediate result, select .
- ▶ The analysis is printed on the connected printer as it appears in the report (n, x, s, sRel, etc.).  
A sample printout can be seen below:

```

-----
n                5
x      + 13.49000 g
s      +  3.60000 g
sRel  + 27.00    %
Sum    + 67.47000 g
Min    +  8.47000 g
Max    + 18.30000 g
Diff   +  9.83000 g
    
```



- ▶ To switch back to the **Statistics** application, select **X**.

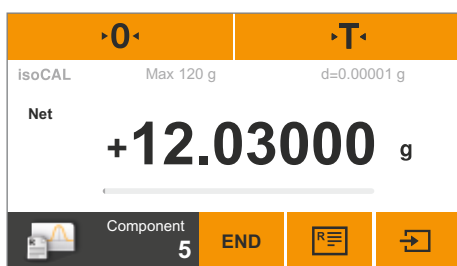

- ▶ Weigh additional components, if any, and display the updated intermediate result.



- ▶ To exit the function, select **END**.
- ▶ The application returns to its original state.



There is an online animation for this application. Click here to view it:



## 7.6 Totalizing Components

**Purpose:** Totalize weight values. You can save up to 99 components. This allows you to save components that must be weighed in various containers. Each container can be tared before each component is weighed.

**Example:** You have a formula, the components of which should not be mixed together immediately. Use this application to weigh individual components in different containers, print out the results, and check the total weight at any time.



▶ Select the menu key in any application.



▶ Select the **Components** symbol in the menu.

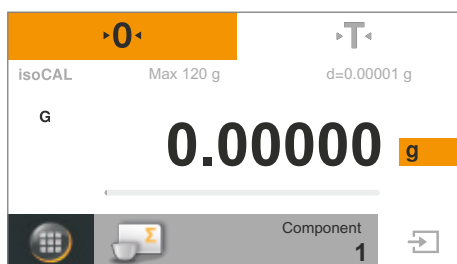

▶ The **Components** application appears.

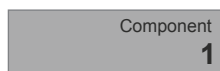

▶ To change the settings, select the gray button.

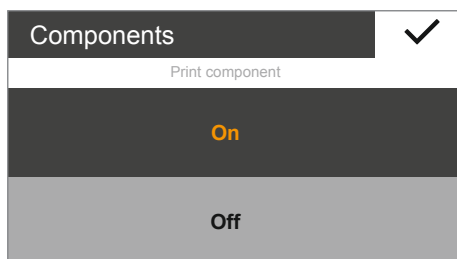

▶ The **Components** settings window appears.

- ▶ Choose whether the individual weights of the components are printed out.
- ▶ Touch ✓ to confirm.



▶ Select **0** to zero the balance if necessary.

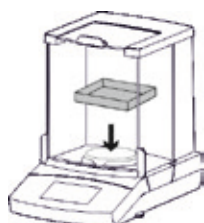

▶ Place the container for the first component on the weighing pan.



▶ Select **T** to tare the balance.

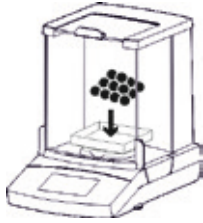

▶ Place the first component on the weighing pan.

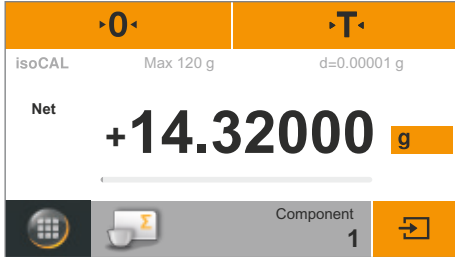

▷ The weight value is displayed.



▶ To save the component, select .



▶ Remove the load from the balance.

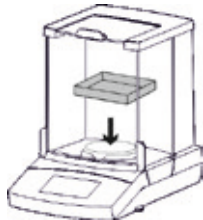

▶ Place the container for the second component on the weighing pan.



▶ Select **T** to tare the balance.



▶ Place the second component on the weighing pan.



▶ To save the component, select .

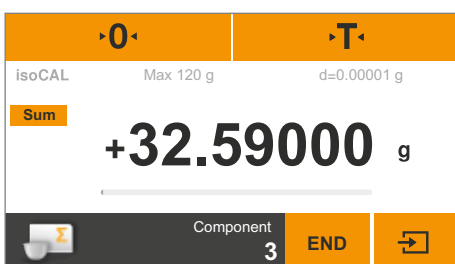

▷ The weight value is displayed.

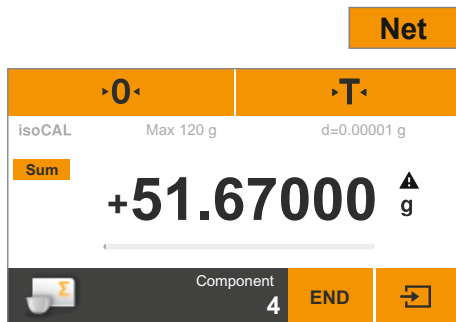
**Net**

- ▶ Continue this procedure with additional components.
- ▶ To view the total weight, select the **Net** button on the weighing display.
- ▶ The total weight of all saved components is displayed.

**Sum**

- ▶ To switch back to view individual weights, select the **Sum** button.

**END**

- ▶ To exit the function, select **END**.
- ▶ The application returns to its original state.

### Printing Results

Requirements: For printouts, a Sartorius YDP40 printer or PC must be connected and configured (see page 78).

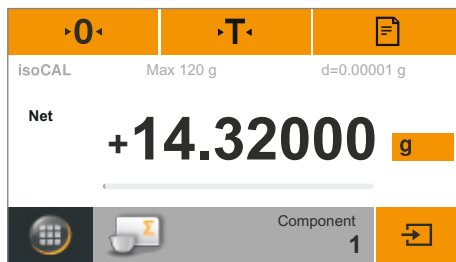

- ▶ If a printer is connected, an additional button automatically appears at the top right of the display.
- ▶ Select  to print the current value.

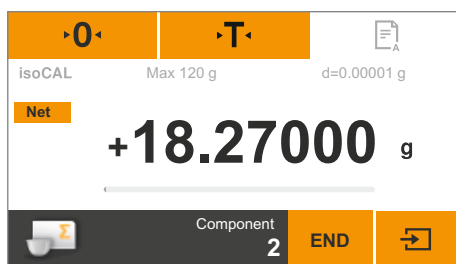

- ▶ When each component is saved, their weight value is printed (**Comp1**, **Comp2**, etc.).
- ▶ Select **END** to print the total weight (**T-Comp**).
- ▶ A sample of the complete printout is given below:

```

-----
Comp1 + 14.32000 g
Comp2 + 18.27000 g
Comp3 + 13.73000 g
T-Comp+ 51.67000 g

```



There is an online animation for this application. Click here to view it:



## 7.7 Density

**Purpose:** Use this application to determine the density of solid samples based on the buoyancy method. The density is determined using Archimedes' Principle. The upward buoyant force exerted on a body immersed in a fluid is equal to the weight of the fluid the body displaces.

### Calculation Basis for Density Determination

Density determination using the buoyancy method is based on the following formula:

$\rho$  Density of sample (Rho)  
 $\rho_{fl}$  Density of buoyancy liquid  
 $W_a$  Weight of sample in air  
 $W_{fl}$  Weight of sample in liquid

**Buoyancy:**  $\rho = (W_a / (W_a - W_{fl})) * \rho_{fl}$

**Requirements:** A Sartorius density determination kit is required for this function (see Chapter "Accessories" on page 103).

Mount the density determination kit on the balance and prepare it as described in the kit instructions.



▶ Select the menu key in any application.



▶ Select the **Density** symbol in the menu.

▷ The **Density** application appears.

The density of the buoyancy liquid is displayed under **Density of liquid**.

The following values are preset for distilled water at various temperatures:

- 0.99823 g/cm<sup>3</sup> at 20°C
- 0.99802 g/cm<sup>3</sup> at 21°C
- 0.99780 g/cm<sup>3</sup> at 22°C

Additional density values can be found in the table on page 57.



Density of liquid  
**0.9982** g/cm<sup>3</sup>

- ▶ To change the density of the buoyancy liquid, select the gray button.

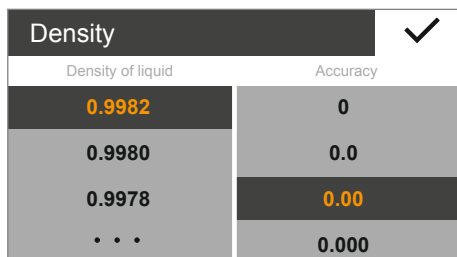

- ▶ The **Density** settings window appears.
- ▶ Enter the density of the buoyancy liquid on the left. Select a value or select **...**, enter the desired value, and confirm with **✓**.
- ▶ Select the accuracy of the density result on the right.
- ▶ Touch **✓** to confirm.

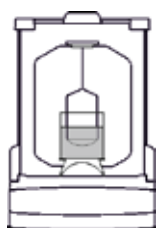

- ▶ Attach the sample holder to the frame of the density determination kit.
- ▶ Fill the beaker in the density determination kit with the buoyancy liquid. Ensure that the sample holder is sufficiently immersed in the liquid in order to hold the sample later.
- ▶ If distilled water is used as the buoyancy liquid, add three drops of tenside to reduce the effect of surface tension on the measurement result.



- ▶ Select **T** to tare the balance.

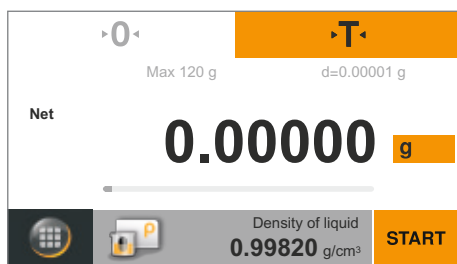

- ▶ The balance is tared with the prepared density determination kit.



- ▶ To begin density determination, select **START**.

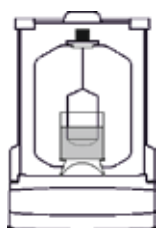

- ▶ Place the sample on the weighing pan above on the frame of the density determination kit.

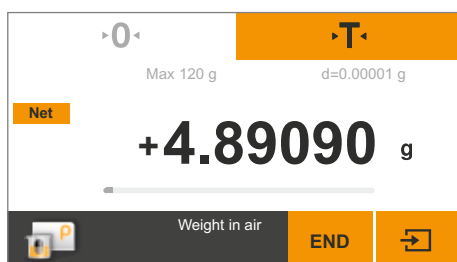

- ▶ The weighing display shows the step **Weight in air**.



- ▶ To save the weight value, select .

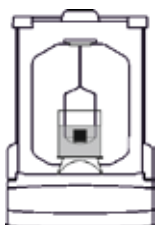

- ▶ Remove the sample from the weighing pan and place it in the sample holder of the density determination kit using forceps.
- ⚠ Ensure that the sample is completely submerged in the buoyancy liquid and that no air bubbles have formed on the sample.

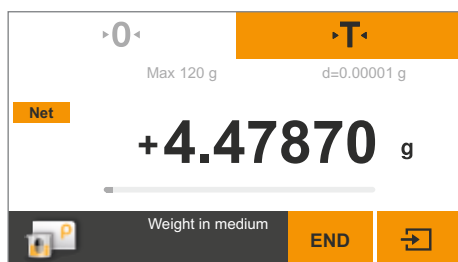

- ▷ The weighing display shows the step **Weight in medium**.



- ▶ To save the weight value, select .

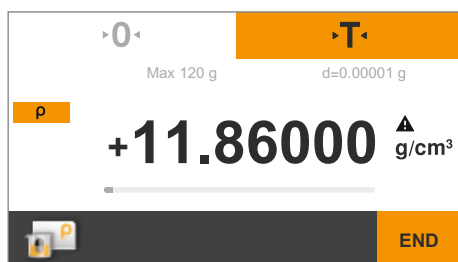

- ▷ The balance calculates the density of the sample and displays this value.



- ▶ To exit the function, select **END**.
- ▷ The application returns to its original state.  
If the GLP printout function is activated, the GLP printout is automatically printed (see page 33).



There is an online animation for this application. Click here to view it:





Density Values of H<sub>2</sub>O at Temperature T (in °C)

T/°C	0.0	0.1	0.2	0.3	0.4	0.5	0.6	0.7	0.8	0.9
10.	0.99973	0.99972	0.99971	0.99970	0.99969	0.99968	0.99967	0.99966	0.99965	0.99964
11.	0.99963	0.99962	0.99961	0.99960	0.99959	0.99958	0.99957	0.99956	0.99955	0.99954
12.	0.99953	0.99951	0.99950	0.99949	0.99948	0.99947	0.99946	0.99944	0.99943	0.99942
13.	0.99941	0.99939	0.99938	0.99937	0.99935	0.99934	0.99933	0.99931	0.99930	0.99929
14.	0.99927	0.99926	0.99924	0.99923	0.99922	0.99920	0.99919	0.99917	0.99916	0.99914
15.	0.99913	0.99911	0.99910	0.99908	0.99907	0.99905	0.99904	0.99902	0.99900	0.99899
16.	0.99897	0.99896	0.99894	0.99892	0.99891	0.99889	0.99887	0.99885	0.99884	0.99882
17.	0.99880	0.99879	0.99877	0.99875	0.99873	0.99871	0.99870	0.99868	0.99866	0.99864
18.	0.99862	0.99860	0.99859	0.99857	0.99855	0.99853	0.99851	0.99849	0.99847	0.99845
19.	0.99843	0.99841	0.99839	0.99837	0.99835	0.99833	0.99831	0.99829	0.99827	0.99825
20.	0.99823	0.99821	0.99819	0.99817	0.99815	0.99813	0.99811	0.99808	0.99806	0.99804
21.	0.99802	0.99800	0.99798	0.99795	0.99793	0.99791	0.99789	0.99786	0.99784	0.99782
22.	0.99780	0.99777	0.99775	0.99773	0.99771	0.99768	0.99766	0.99764	0.99761	0.99759
23.	0.99756	0.99754	0.99752	0.99749	0.99747	0.99744	0.99742	0.99740	0.99737	0.99735
24.	0.99732	0.99730	0.99727	0.99725	0.99722	0.99720	0.99717	0.99715	0.99712	0.99710
25.	0.99707	0.99704	0.99702	0.99699	0.99697	0.99694	0.99691	0.99689	0.99686	0.99684
26.	0.99681	0.99678	0.99676	0.99673	0.99670	0.99668	0.99665	0.99662	0.99659	0.99657
27.	0.99654	0.99651	0.99648	0.99646	0.99643	0.99640	0.99637	0.99634	0.99632	0.99629
28.	0.99626	0.99623	0.99620	0.99617	0.99614	0.99612	0.99609	0.99606	0.99603	0.99600
29.	0.99597	0.99594	0.99591	0.99588	0.99585	0.99582	0.99579	0.99576	0.99573	0.99570
30.	0.99567	0.99564	0.99561	0.99558	0.99555	0.99552	0.99549	0.99546	0.99543	0.99540

## Density Values of Ethanol at Temperature T (in °C)

T/°C	0.0	0.1	0.2	0.3	0.4	0.5	0.6	0.7	0.8	0.9
10.	0.79784	0.79775	0.79767	0.79758	0.79750	0.79741	0.79733	0.79725	0.79716	0.79708
11.	0.79699	0.79691	0.79682	0.79674	0.79665	0.79657	0.79648	0.79640	0.79631	0.79623
12.	0.79614	0.79606	0.79598	0.79589	0.79581	0.79572	0.79564	0.79555	0.79547	0.79538
13.	0.79530	0.79521	0.79513	0.79504	0.79496	0.79487	0.79479	0.79470	0.79462	0.79453
14.	0.79445	0.79436	0.79428	0.79419	0.79411	0.79402	0.79394	0.79385	0.79377	0.79368
15.	0.79360	0.79352	0.79343	0.79335	0.79326	0.79318	0.79309	0.79301	0.79292	0.79284
16.	0.79275	0.79267	0.79258	0.79250	0.79241	0.79232	0.79224	0.79215	0.79207	0.79198
17.	0.79190	0.79181	0.79173	0.79164	0.79156	0.79147	0.79139	0.79130	0.79122	0.79113
18.	0.79105	0.79096	0.79088	0.79079	0.79071	0.79062	0.79054	0.79045	0.79037	0.79028
19.	0.79020	0.79011	0.79002	0.78994	0.78985	0.78977	0.78968	0.78960	0.78951	0.78943
20.	0.78934	0.78926	0.78917	0.78909	0.78900	0.78892	0.78883	0.78874	0.78866	0.78857
21.	0.78849	0.78840	0.78832	0.78823	0.78815	0.78806	0.78797	0.78789	0.78780	0.78772
22.	0.78763	0.78755	0.78746	0.78738	0.78729	0.78720	0.78712	0.78703	0.78695	0.78686
23.	0.78678	0.78669	0.78660	0.78652	0.78643	0.78635	0.78626	0.78618	0.78609	0.78600
24.	0.78592	0.78583	0.78575	0.78566	0.78558	0.78549	0.78540	0.78532	0.78523	0.78515
25.	0.78506	0.78497	0.78489	0.78480	0.78472	0.78463	0.78454	0.78446	0.78437	0.78429
26.	0.78420	0.78411	0.78403	0.78394	0.78386	0.78377	0.78368	0.78360	0.78351	0.78343
27.	0.78334	0.78325	0.78317	0.78308	0.78299	0.78291	0.78282	0.78274	0.78265	0.78256
28.	0.78248	0.78239	0.78230	0.78222	0.78213	0.78205	0.78196	0.78187	0.78179	0.78170
29.	0.78161	0.78153	0.78144	0.78136	0.78127	0.78118	0.78110	0.78101	0.78092	0.78084
30.	0.78075	0.78066	0.78058	0.78049	0.78040	0.78032	0.78023	0.78014	0.78006	0.77997

## 7.8 Percentage

**Purpose:** This application is used to determine the percentage share or the percentage difference of the sample related to a reference weight.



▶ Select the menu key in any application.

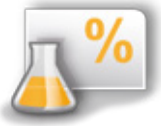

▶ Select the **Percentage** symbol in the menu.

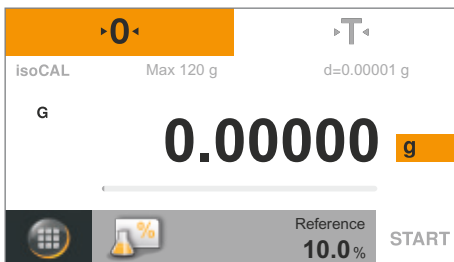

▶ The **Percentage** application appears.  
The reference percentage is displayed under **Reference** (e.g., 10.0%).

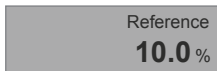

▶ To change the reference percentage, select the gray button.

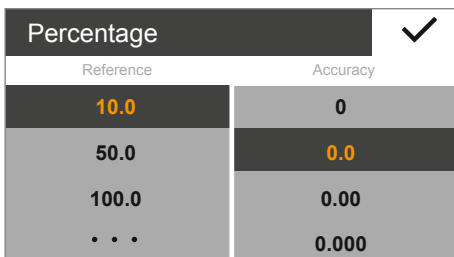

▶ The **Percentage** settings window appears.

▶ Enter the reference percentage on the left.  
Select a value or select ..., enter the desired value, and confirm with ✓.

▶ Select the accuracy of the percentage display on the right.

▶ Touch ✓ to confirm.



▶ Select **0** to zero the balance if necessary.

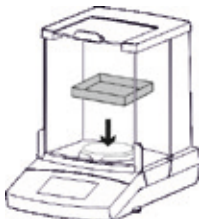

▶ Place a container on the weighing pan.



▶ Select **T** to tare the balance.

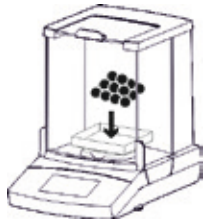

- ▶ Place the reference sample on the weighing pan.



- ▶ The weight of the reference sample is displayed.

**START**

- ▶ Select **START**.

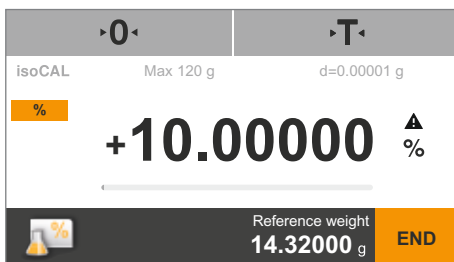

- ▶ The reference percentage is displayed.  
The weight of the reference sample is displayed under **Reference weight**.
- ▶ Remove the reference sample from the balance.



- ▶ Place the unknown sample on the weighing pan.

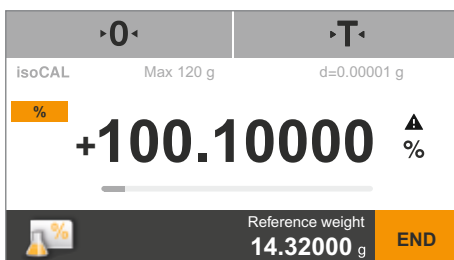

- ▶ The balance shows the percentage of the sample based on the reference sample.

**%**

▶ To view the sample weight, select the **%** button on the weighing display.

▷ The weight of the sample is displayed.

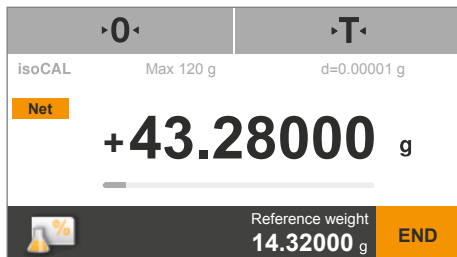
**Net**

▶ To change back to viewing the percentage, select the **Net** button again.

▶ Place additional samples on the weighing pan, if any, to calculate their percentages based on the reference sample.

**END**

▶ To exit the function, select **END**.

▷ The application returns to its original state.



There is an online animation for this application. Click here to view it:



## 7.9 Conversion

**Purpose:** Use this application to multiply the weight value by a user-defined factor. Division is also possible if a factor of less than one is selected. The selected factor is saved to protected memory.

**Example:** You want to calculate the weight per unit of a sheet of paper (DIN A4).

To do so, proceed as follows:

- The weight per unit (e.g., 80 g/m<sup>2</sup>) can be determined by dividing the weight by the surface.
- The surface of a sheet of DIN A4 paper is:  $0.210 + 0.297 = 0.06237$  m<sup>2</sup>.
- Division by 0.06237 is equal to multiplication by reciprocal value  $1 / 0.06237$ , i.e., 16.03335.
- Set the factor to 16.03335 in the application.



- ▶ Select the menu key in any application.
- ▶ Select the **Conversion** symbol in the menu.



- ▶ The **Conversion** application appears. The multiplier is displayed under **Factor**.



- ▶ To set the factor and accuracy of the conversion, select the gray button.

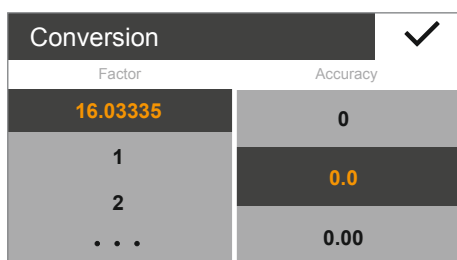

- ▶ The **Conversion** settings window appears.
- ▶ On the left, enter the factor by which the weight of the sample will be multiplied. Select a value or select ..., enter the desired value, and confirm with ✓.
- ▶ Select the accuracy of the conversion display on the right.
- ▶ Touch ✓ to confirm.



- ▶ Select **0** to zero the balance if necessary.



- ▶ Select **START**.



- ▶ Place the sample on the weighing pan.



- ▶ The weight of the sample is multiplied by the entered factor, and the result is displayed.



- ▶ Place additional samples on the weighing pan, if any, to multiply their weights by the entered factor.



- ▶ To view the measured individual weight of the sample, select the **Res** button on the weighing display.



- ▶ The individual weight of the sample is displayed.



- ▶ To switch back to the calculated result, select the "Net/G" button again.



- ▶ To exit the function, select **END**.
- ▶ The application returns to its original state.



There is an online animation for this application. Click here to view it:



## 7.10 Unstable Condition

**Purpose:** This application is used for moving samples (e.g., live animals) and for weighing in unstable environments. A measurement cycle is automatically carried out with a defined number of measurements for each object to be weighed. The individual measurements are averaged, and this average is displayed as the result.



- ▶ Select the menu key in any application.



- ▶ Select the **Unstable condition** symbol in the menu.

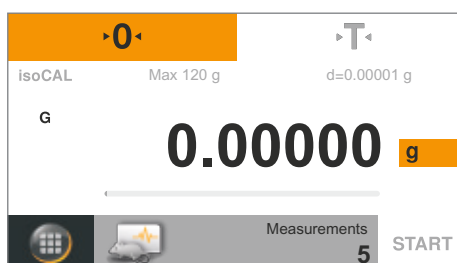

- ▶ The **Unstable condition** application appears. The set number of measurements is displayed under **Measurements**.

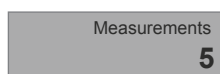

- ▶ To set the number of measurements and define other settings, select the gray button.

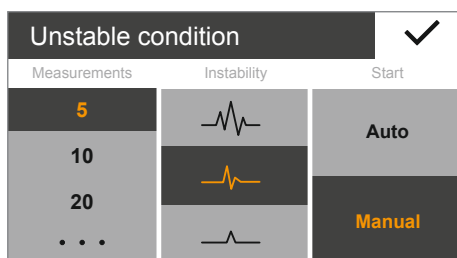

- ▶ The **Unstable condition** settings window appears.
- ▶ Enter the number of measurements on the left. Select the number of measurements on the left or select **...**, enter the desired value, and confirm with **✓**.
- ▶ Select the degree of instability of movement in the middle (e.g., for the starting criterion of the measurement).
- ▶ On the right, choose whether the measurements are started manually with **Manual** or **Auto**.
- ▶ Touch **✓** to confirm.



- ▶ Select **0** to zero the balance if necessary.

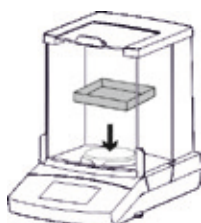

- ▶ To weigh a living animal, place a container or cage on the weighing pan.



- ▶ Select **T** to tare the balance.

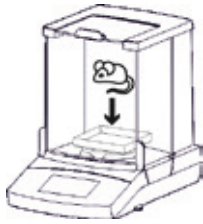

- ▶ Place the animal in the container.

**START**

- ▶ If the start of measurement is set to **Manual**, select **START**.  
If the start of measurement is set to **Auto**, the measurement begins as soon as the individual weight values fall within the preset fluctuation range/instability.

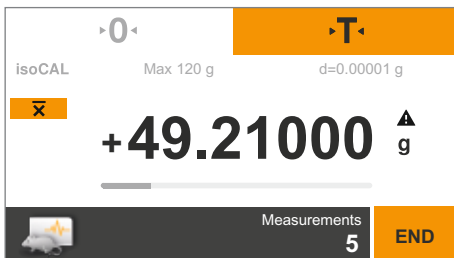

- ▶ The specified number of measurements is carried out. The average is calculated and displayed.

**x̄**

- ▶ To view the current weight value, select the **x̄** button on the weighing display.

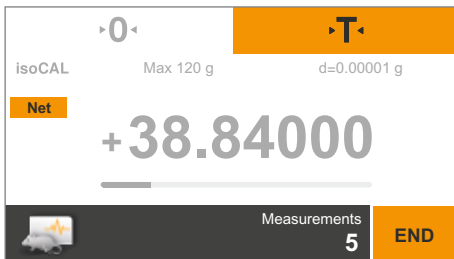

- ▶ The (fluctuating) current weight value is displayed in gray.

**Net**

- ▶ To change back to viewing the calculated average, select the **Net** button again.

**END**

- ▶ To exit the function, select **END**.

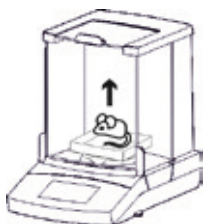

Or remove the sample from the weighing pan.

- ▶ The application returns to its original state.



There is an online animation for this application. Click here to view it:





## 7.11 Checkweighing

**Purpose:** Use this application to check whether a weight value falls within the specified tolerances. This application also makes it easy to fill sample materials to a specified target weight.



- ▶ Select the menu key in any application.
- ▶ Select the **Checkweighing** symbol in the menu.



- ▶ The **Checkweighing** application appears. The set thresholds are displayed under **Min** and **Max**.

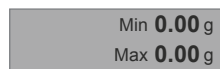

- ▶ To set the thresholds, select the gray button.



- ▶ The **Checkweighing** settings window appears.
- ▶ Select or enter the lower threshold (minimum) and the upper threshold (maximum).  
Select ..., enter the desired value, and confirm with ✓.
- ▶ Touch ✓ to confirm.



- ▶ The set thresholds are displayed.



- ▶ Select **0** to zero the balance if necessary.

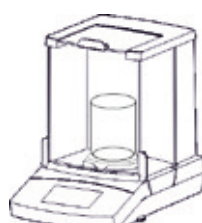

- ▶ Place a container on the weighing pan.



- ▶ Select **T** to tare the balance.



- ▶ Select **START**.



- ▶ Place the sample on the weighing pan.

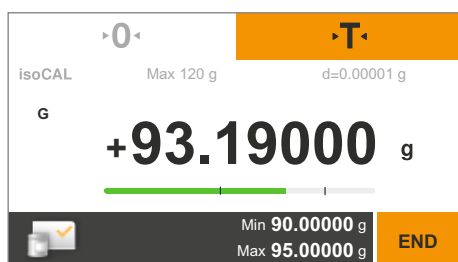

- ▶ The weight value is displayed.  
The colored bar indicates whether the weight value falls within the thresholds:
  - Yellow: The weight value is too low.
  - Green: The weight value is OK and falls within the specified range.
  - Red: The weight value is too high.

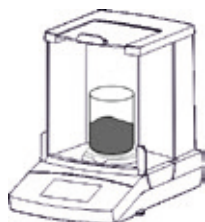

- ▶ Add the sample to the weighing pan until the desired value is reached, or place other samples, if any, on the weighing pan for checkweighing.



- ▶ To exit the function, select **END**.
- ▶ The application returns to its original state.



There is an online animation for this application. Click here to view it:



## 7.12 Peak Hold

**Purpose:** Use this application to calculate the maximum weight value of a sample (peak value). The value remains on the display for five seconds after the sample has been removed from the balance.

**Example:** You wish to measure the release force during an experiment.



▶ Select the menu key in any application.



▶ Select the **Peak hold** symbol in the menu.

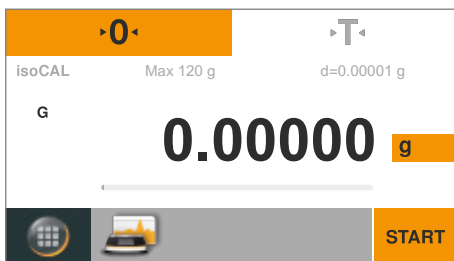

▶ The **Peak hold** application appears.



▶ To define the setting for calculating the peak hold, select the gray button.

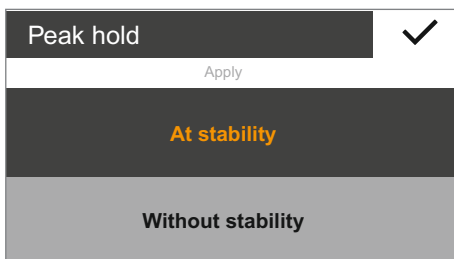

▶ The **Peak hold** settings window appears.

- ▶ Choose whether the peak hold (max. value) is calculated **At stability** or **Without stability**.
  - The **At stability** setting is suitable for stable samples. It ensures that the weight value fluctuations when placing or removing the sample from the balance do not cause the calculated peak value to be incorrect.
  - The **Without stability** setting is suitable for unstable samples.
- ▶ Touch ✓ to confirm.



▶ Select **0** to zero the balance if necessary.



▶ Select **START**.

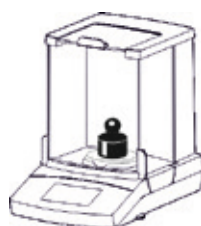

▶ Place the sample on the weighing pan.

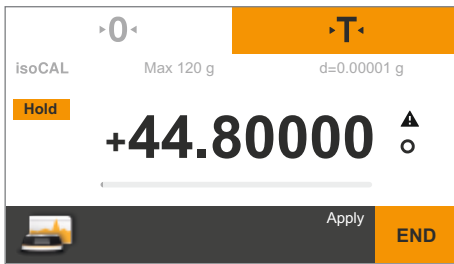

- ▶ The maximum measured weight value is displayed and kept as long as the sample remains on the balance.

**Hold**

- ▶ To view the current weight value, select the **Hold** button on the weighing display.
- ▶ The current weight value is displayed.

**G**

- ▶ To change back to viewing the peak hold (max. value), select the **G** or **Net** button again.
- ▶ Remove the sample from the weighing pan.
- ▶ In the "Hold" display mode the balance displays the peak hold (max. value) for another five seconds before switching back to zero.
- ▶ Place the additional samples, if any, on the weighing pan.

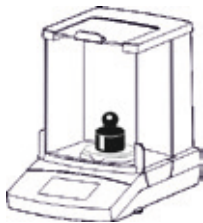

**END**

- ▶ To exit the function, select **END**.
- ▶ The application returns to its original state.



There is an online animation for this application. Click here to view it:



## 7.13 Counting

**Purpose:** Use this application to determine the number of parts of approximately equal weight. The weight of a counted reference sample is calculated and then the objects with an unknown piece count are weighed. The balance displays the number of parts and the piece weight.

**Minimize counting errors:**

- Ensure that the weight of individual parts is evenly distributed.
- Larger reference piece counts lead to a higher degree of accuracy.
- Switch on Auto Reference Updating.



- ▶ Select the menu key in any application.



- ▶ Select the **Counting** symbol in the menu.

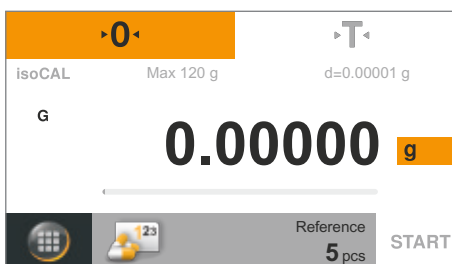

- ▶ The **Counting** application appears. The piece count of the reference sample is displayed under **Reference**.

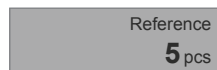

- ▶ To set the reference sample quantity, select the gray button.

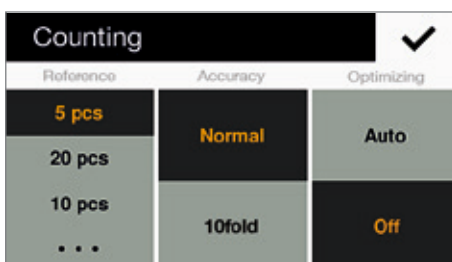

- ▶ The **Counting** settings window appears.

- ▶ Enter the reference sample quantity on the left. Select a value or select ..., enter the desired value, and confirm with ✓.
- ▶ Select the accuracy of the weight value during counting in the middle.
- ▶ Activate "Automatic Reference Sample Updating" on the right. Automatic reference sample updating optimizes the counting accuracy. The average piece weight is recalculated every time the reference sample is updated automatically. Since the new parts broaden the basis for the calculation, this increases the counting accuracy of the reference and with it the result.

- ▶ Touch ✓ to confirm.



- ▶ Select **0** to zero the balance if necessary.

- ▶ Place a container on the weighing pan.

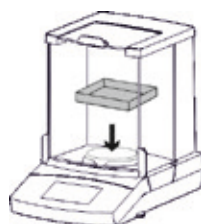



▶ Select **T** to tare the balance.

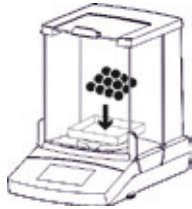

▶ Place the set number of reference samples on the weighing pan.

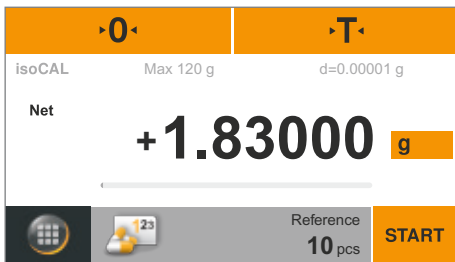

▷ The weight value is displayed.



▶ Select **START**.

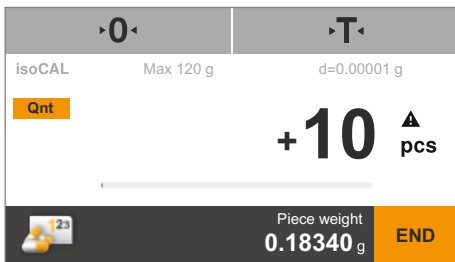

▷ The weighing displays changes and shows the piece count. The average piece weight is shown on the weighing display. "Update automatically" setting:

▷ If the balance is performing the automatic reference sample update, "Update" will display the new average piece weight.

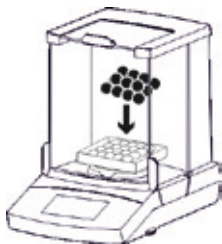

▶ Place the sample with the unknown piece count on the weighing pan.

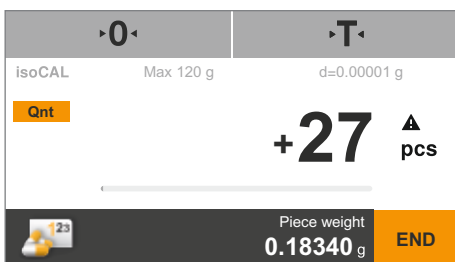

▷ The piece count is calculated and displayed.

▶ Place other pieces, if any, on the balance to reach a specific desired count.

**Qnt**

- ▶ To view the total weight of the sample, select the **Qnt** button on the weighing display.

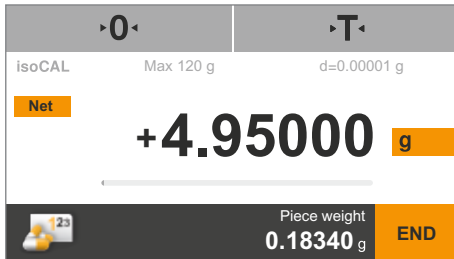

- ▶ The total weight of the sample is displayed.

**Net**

- ▶ To change back to viewing the piece count, select the **Net** button again.

**END**

- ▶ To exit the function, select **END**.
- ▶ The application returns to its original state.



There is an online animation for this application. Click here to view it:



## 8. Calibration and Adjustment

**Background** During **calibration**, a calibration weight is used to determine how much the displayed value deviates from the actual measurement value. This deviation is compared against a preset target value. The subsequent **adjustment** corrects this deviation or reduces the permissible error limits.  
In Secura® and Quintix® balances, calibration and adjustment are combined as one process. The balance is automatically adjusted after each calibration.

---

**M**

Before using a verified balance for legal metrology, calibration/adjustment must always be carried out at the balance setup location. This can be performed automatically or manually.

---

**When and How Often** To achieve the highest accuracy possible, regularly calibrate and adjust the balance:

- daily after switching on the balance.
- each time the balance is leveled.
- each time ambient conditions have changed (temperature, humidity, or air pressure).
- each time the balance is set up at a new location or moved in its current location.

The following describes in detail the available options for calibrating and adjusting the balance:

- Calibration/adjustment using an internal calibration weight
- Calibration/adjustment using an external calibration weight (see "Calibration/Adjustment Using an External Calibration Weight" on page 74)
- Automatic calibration/adjustment with isoCAL



## 8.1 Calibration/Adjustment Using an Internal Calibration Weight

The balance is fitted with an internal calibration weight in the housing. This calibration weight is automatically placed on the balance by a motor during internal calibration and adjustment.

- ▶ Ensure that the balance is stable, the draft shield is closed, and the weighing pan is empty.



- ▶ Select **0** to zero the balance.



- ▶ Select the menu key at the bottom left of the display in the current application.

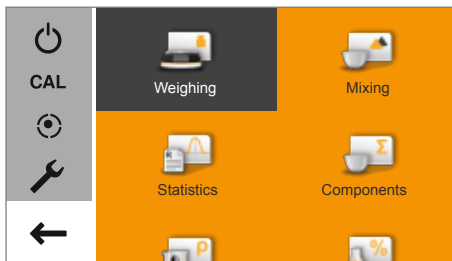

- ▶ The menu appears.



- ▶ Select the **CAL** button to access the calibration function.

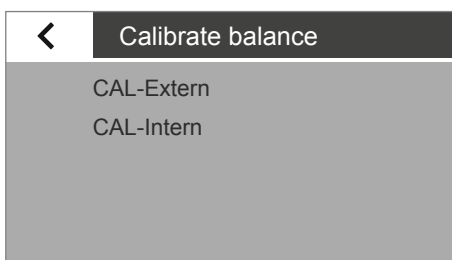

- ▶ The **Calibrate balance** window appears.

- ▶ Select **CAL-Intern**.

- ▶ Calibration begins.
  - The internal weight is automatically placed on the balance in the housing.
  - The balance is calibrated and then immediately adjusted.
  - The internal weight is automatically removed from the balance.

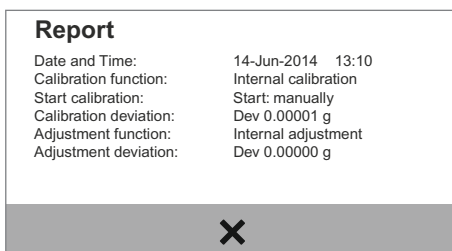

- ▶ A report appears on the display. The report indicates the deviations identified during calibration. The report also gives the result of the adjustment process.

- ▶ Close the report window: Select **X**.

- ▶ The balance is now calibrated and adjusted.



Information on potential errors can be found in Chapter "Status Messages" on page 90.

## 8.2 Calibration/Adjustment Using an External Calibration Weight



An external calibration weight is required for this function. Please note the tolerance of the calibration weight being used.



In verified balances with accuracy class  $\text{E1}$ , external adjustment can only be accessed when the access switch is open.

- ▶ Make sure that the weighing pan is empty.
- ▶ Select **0** to zero the balance.
- ▶ Select the menu key at the bottom left of the display in the current application.



- ▶ The menu appears.

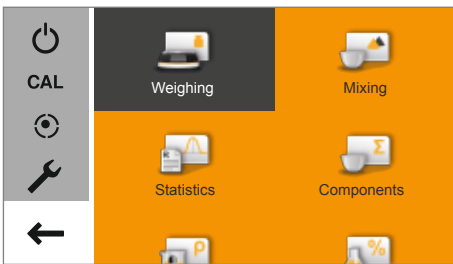

- ▶ Select the **CAL** button to access the calibration function.

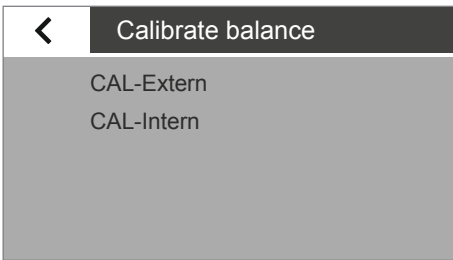

- ▶ The **Calibrate balance** window appears.
- ▶ Select **CAL-Extern**.
- ▶ A message appears on the display, prompting the user to place the calibration weight on the weighing pan.
- ▶ Place the calibration weight on the weighing pan.
- ▶ Calibration starts automatically.

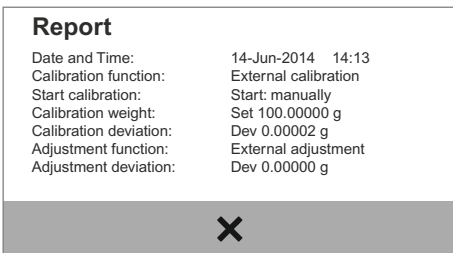

- ▶ A report appears on the display. The report indicates the deviations identified during calibration. The report also gives the result of the adjustment process.
- ▶ Close the report window: Select **X**.
- ▶ The balance is now calibrated and adjusted.



Information on potential errors can be found in Chapter "Status Messages" on page 90.

## 8.3 Automatic Calibration/Adjustment with isoCAL

Fully automatic calibration/adjustment ensures that the balance is automatically calibrated and adjusted when predefined time intervals or temperature values are exceeded.

This function varies in different models:

- isoCAL is automatically carried out based on time or temperature, and each time the balance is leveled. This function can be switched off via the system settings (see page 30).



In Secura® models, every adjustment process, including the identified deviations, is documented and saved on the balance. The saved reports can be viewed via the system settings and printed out on a PC or Sartorius lab printer (see page 30).

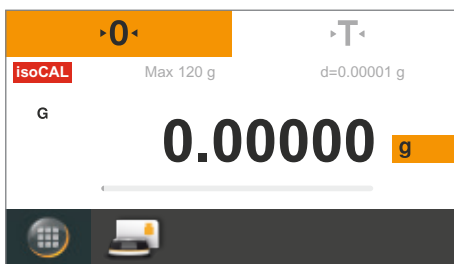

- ▷ If the ambient temperature has changed since the last calibration/adjustment or the preset time interval has been exceeded, the red **isoCAL** button appears on the display.

- ▷ If the **isoCAL** function is set to **Automatic**, the calibration/adjustment process starts automatically.

- ⚠ If the balance has not been adjusted, the prompt will be shown again 5 minutes after the "isoCAL" status message is acknowledged.

- ▷ If the **isoCAL** function is set to **Info, manual start**, the function must be started manually.

**isoCAL**

- ▶ To start the calibration/adjustment function manually, select the **isoCAL** button.

- ▷ Calibration starts automatically.

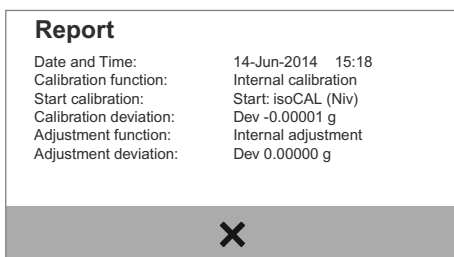

- ▷ A report appears on the display. The report indicates the deviations identified during isoCAL calibration. The report also gives the result of the adjustment process.

- ▶ Close the report window: Select **X**.

- ▷ The balance is now calibrated and adjusted.

## 9. ISO/GLP-compliant Printout

### Characteristics

The device information, ID, and the current date can be printed before (GLP header) and after (GLP footer) the values from the weighing series.

The following data is printed:

GLP header:

- Date, time at the start of a weighing series
- Balance manufacturer
- Balance model
- Model serial number
- Software version number of the balance (BAC)
- Software version number of the display (APC)
- Two identification numbers (ID and A ID) with max. 14 characters (ASCII)
  
- Device and batch ID with max. 14 characters (if activated in the system settings)

GLP footer:

- Date
- Time at the end of a weighing series
- Field for signature

### Configuration



To print out the ISO/GLP report, define the following system settings (see page 33):

- ▶ Activate ISO/GLP-compliant printouts:  
Go to the **Printout** menu, select "Manual with stability," and then under **Manual print**, set the **ISO/GLP printout** option to **On**.
- ▶ Set printout format of date and time:  
Go to the **Printout** menu, and then under **Manual print**, select **Manual print format** and choose a setting.



- Select any setting except "Value w/o identifier." The ISO/GLP printout is not printed if "Value w/o identifier" is set when connected to a PC.
- The ISO/GLP printout is only printed if the "Manual with stability" setting is selected under Printout.  
The "Value w/o identifier" menu option is only displayed if data is being output to a PC.

### Operation

- ▶ To print the header and the first measurement value: Select the  key.
- ▷ To print the header and start an application: Select the **START** key.
- ▷ The header is included with the first printout.
  
- ▷ To print the results of the application and the footer: Select the **END** key.
  
- ▶ To print the footer: Select the  key.

- ▷ The ISO/GLP-compliant printout can have the following lines (configuration using date/time "DD-MMM-YYYY" and "12h AM/PM"):

```

-----
09-Nov-2014    02:50 pm
      Sartorius
Mod.      Secura 125-1S
SerNo.    0032109091
BAC:      00-50-05
APC:      01-71-02
ID        Device 1234
A ID      Inv.-Nr. 11
-----
L ID                               CH01
09-Nov-2014    02:50 pm
S ID      Tablette 4321
N +      0.90000 g
T +      0.60000 g
G#       + 1.50000 g
-----
09-Nov-2014    02:50 pm
Name:
-----

```

- ▷ A sample ISO/GLP printout for external calibration/adjustment can be seen below (configuration using ISO date/time):

```

-----
2014-11-23      14:57
      Sartorius
Mod.      Secura 125-1S
SerNo.    0032109091
BAC:      00-50-05
APC:      01-71-02
ID        Device 1234
A ID      Inv.-Nr. 11
-----
2014-11-23      14:57
External calibration
Start:      manually
Set  +  50.00000 g
Dev  +  3.00000 g
External adjustment
Dev      0.00000 g
-----
2014-11-23      14:57
Name:
-----

```

# 10. USB Port

## 10.1 Communication with Peripheral Devices



The following steps may not be able to be carried out due to restricted user authorizations. Contact your company's IT department if problems occur.

**Purpose:** The interface is used to exchange data with connected peripheral devices: Measured values and calculated values can be output to a printer, PC, or remote display; conversely, control commands and data inputs can be sent via connected devices (such as a PC). The protocols SBI and xBPI can be transmitted via the USB port.

The following connections to peripheral devices are possible:

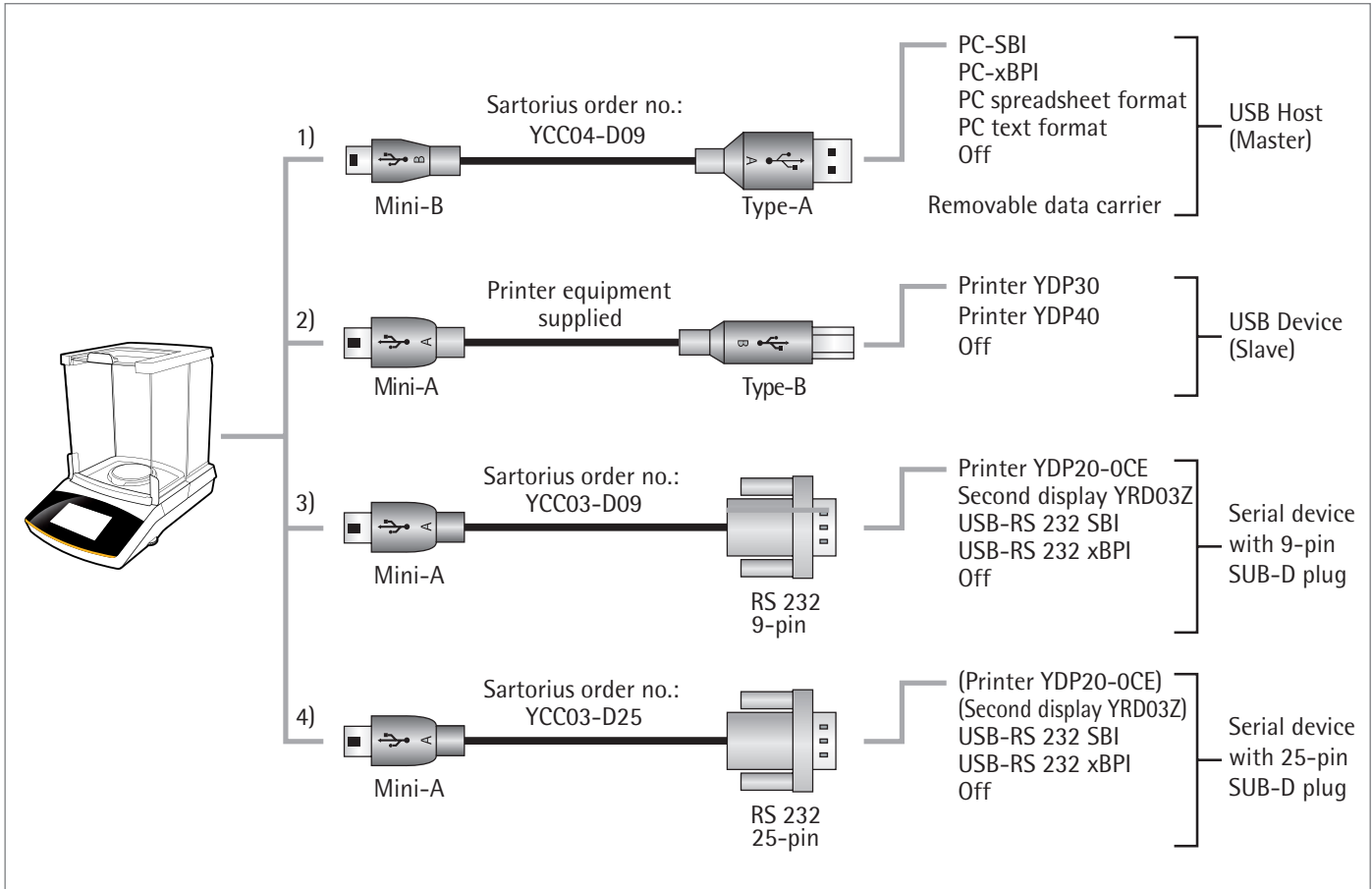

## 10.2 Direct Transfer of Data (PC)

### Requirements:

- PC with Windows 7, Vista, Windows XP, or 2000 operating system
- A to Mini-B USB connection cable from PC to balance, Sartorius order no. YCC04-D09

**M**

In legal metrology data can be transmitted to a PC and used with an Alibi memory. The balance does not have its own Alibi memory. Connection to a printer or Alibi printer is permitted.

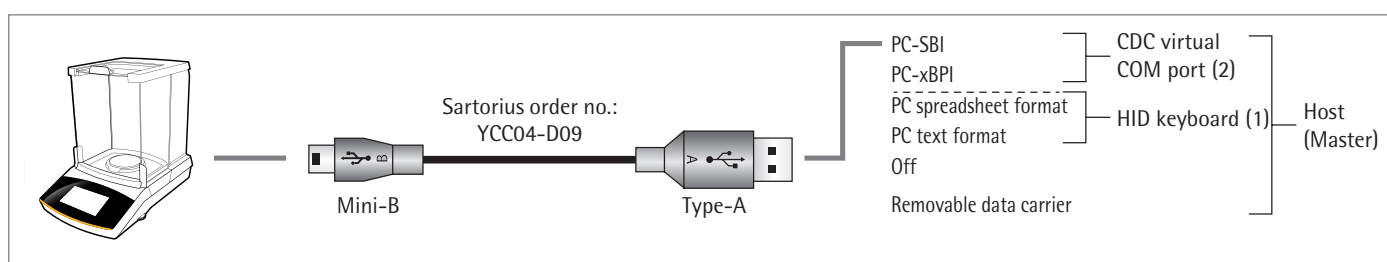

### (1) USB Connection as PC Keyboard without Additional Driver via a PC with Spreadsheet or Text Editor (e.g., Microsoft Office or OpenOffice)

- ▶ Connect the balance to the PC using the supplied USB connection cable.
- ▶ To access the system settings of the balance, select  (Setup) in the menu.
- ▶ To access the **PC spreadsheet format** menu option on the balance: Go to **USB port** and select the **Device/Protocol** option.

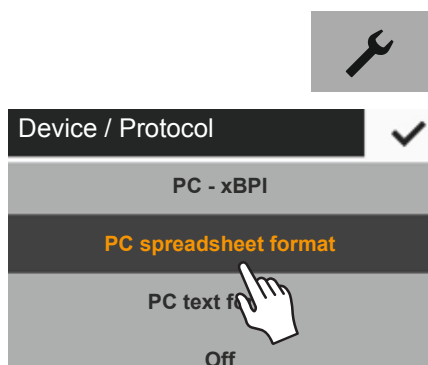

### Setting Options

- ▶ If you need to adjust the balance to match the settings on your PC, you can implement the following system settings:
  - For the spreadsheet, the decimal place and output format: See "System Settings" on page 35
  - Emulation of the PC keyboard for English (USA) instead of Universal (Num Lock on): See "System Settings" on page 35

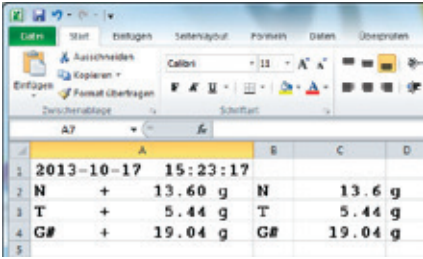

- ▷ With the "PC spreadsheet format" setting on the balance, **Microsoft Excel 2010** has the following display for the "Gross/Tare/Net" example:

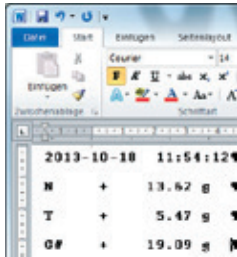

- ▷ With the "PC text format" setting on the balance, **Microsoft Word 2010** has the following display for the "Gross/Tare/Net" example: Gross/Tare/Net

**Additional Data Transmission Settings on the PC [Keyboard Set to English (USA)]**

To ensure that the data is imported correctly from the balance using the spreadsheet or text program, the Office program installed on your PC needs to be configured.

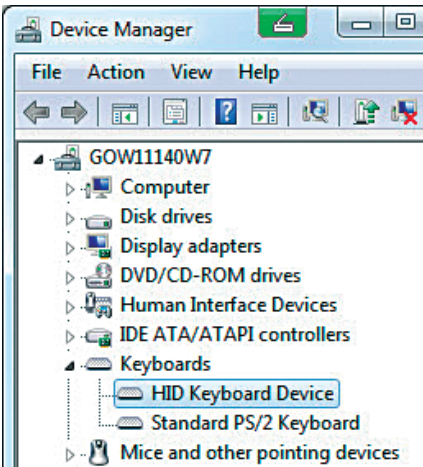

- ▷ Function test:
  - The **HID keyboard** connection appears in the Device Manager of the PC under **Connections – Keyboards**.



- ▷ Set the language to English (USA) – U.S. in the language toolbar of the PC (e.g., in the taskbar).  
 Note: If English (UK) is chosen, "G£" is printed instead of "G#."



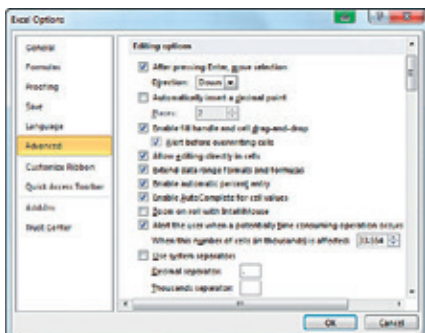

- ▶ Configure how Microsoft Excel treats numbers:  
In Excel, go to **File – Options – Advanced – Editing options** and set the following separators:
  - Decimal separator: Period
  - Thousand separator: Empty (none)

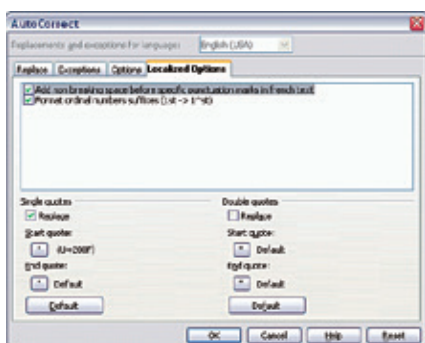

- ▶ Configure the typographical quotation marks for OpenOffice Calc:  
In Calc, go to **Tools – Autocorrect Options – Custom Quotes** and set the following "Simple quotes":
  - At the beginning of a word: empty space (U+200F)
  - At the end of a word: " ' "

▷ Once data has been transferred to your PC, the following appears on the PC:

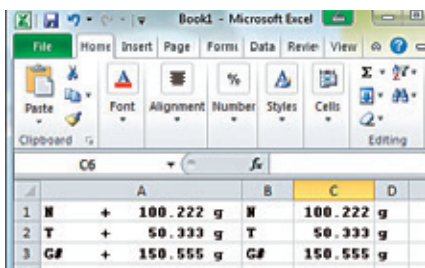

- Microsoft Excel 2010 (example): Gross/Tare/Net

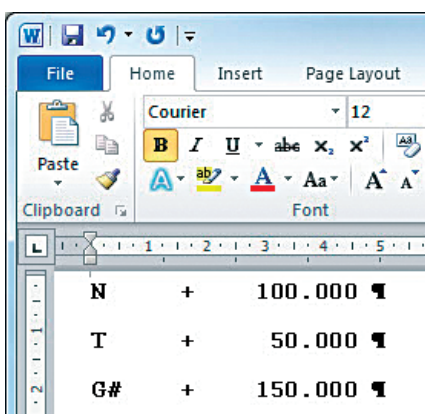

- With the **PC text format** setting on the balance, Microsoft Word 2010 has the following display for the "Gross/Tare/Net" example: Gross/Tare/Net

**(2) USB Connection: PC-SBI and PC-xBPI Operating Mode**

To use the balance as a slave device for the protocols PC-SBI and PC-xBPI, first install a USB driver on the connected PC. This driver can be located in the "Driver" folder on the balance.

The balance is then operated via a virtual, serial interface (COM port).

**Installing the USB Driver**



The USB driver for the virtual, serial interface is Microsoft-listed and available online via the Microsoft Update Service.

A USB driver does not need to be installed if the PC is connected to a network and has administrator rights (authorization to install updates). The driver is installed automatically on the PC in this case when the balance is connected to the PC.

If the PC is not connected to a network, the following information must be taken into account:

- ▶ Connect the balance to the PC using the supplied USB connection cable.
- ▶ To access the system settings of the balance, select  (Setup) in the menu.
- ▶ To access the **USB mass storage** menu option on the balance: Go to **More settings** and select the **USB mass storage** option.

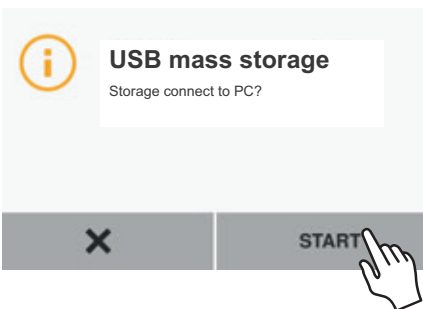
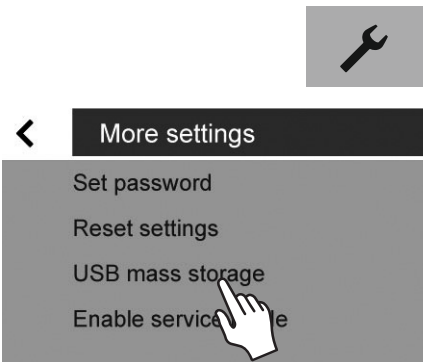

- ▶ To connect the balance memory to the PC: Select **Start**.

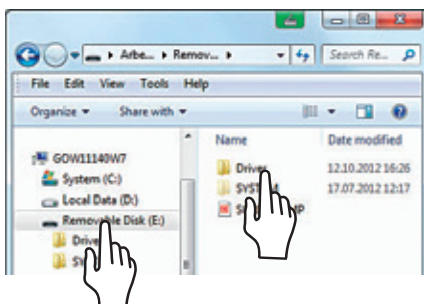

- ▶ To install the installation program for the USB driver on the PC:  
Click on the appropriate removable data carrier (in this case, the E: drive) and then click on the **Driver** folder.

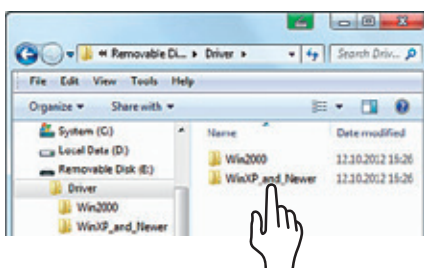

- ▶ To select the Windows version:  
Click on the appropriate version of the PC.

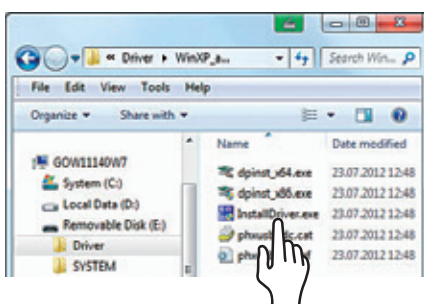

- ▶ Start the installation program **InstallDriver.exe**.

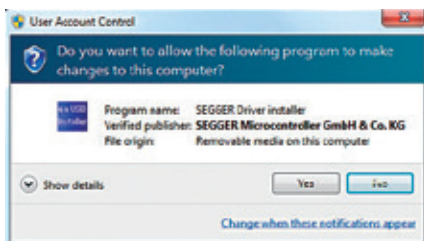

- ▶ Follow the instructions from the installation program.

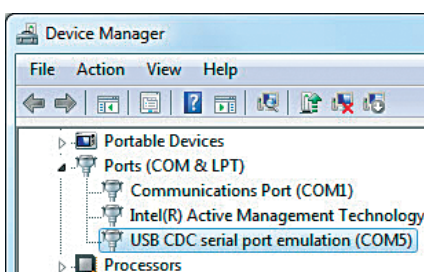

- ▶ Function test:
  - Once the driver is installed, operating modes "PC-SBI" and "PC-xBPI" are available.
  - The "USB CDC serial port emulation" connection appears in the Device Manager of your PC under Connections.



Note: This does not apply to operating modes "PC spreadsheet format," "PC text format," and "Off."

The data transfer commands can be found in Chapter "Data Input Formats."

### Connection with Sartorius Lab Printer YDP30, YDP40

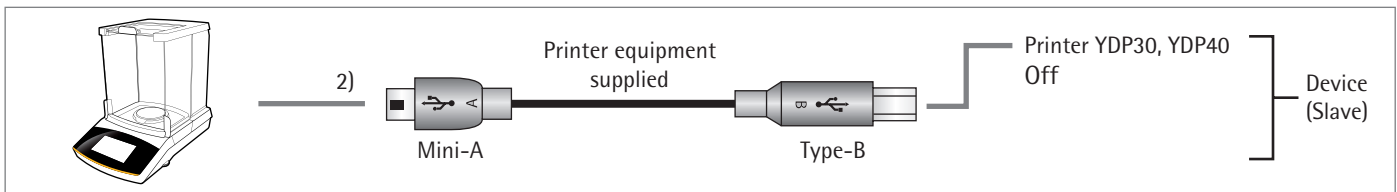

- ▶ Connect the balance to the Sartorius printer using the supplied USB connection cable.
- ▶ The balance detects the printer automatically. No settings need to be changed.

### Connection for 9-pin RS-232 Configuration

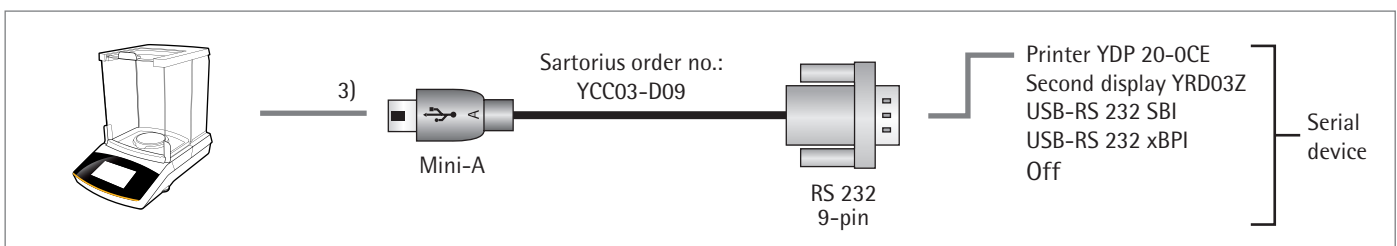

- ▶ Connect the peripheral device to the balance using the Sartorius YCC03-D09 connection cable (RS-232, 9-pin, PC-compliant assignment).
- ▶ Define the desired system settings:  
See page 35.

### Connection for 25-pin RS-232 Configuration

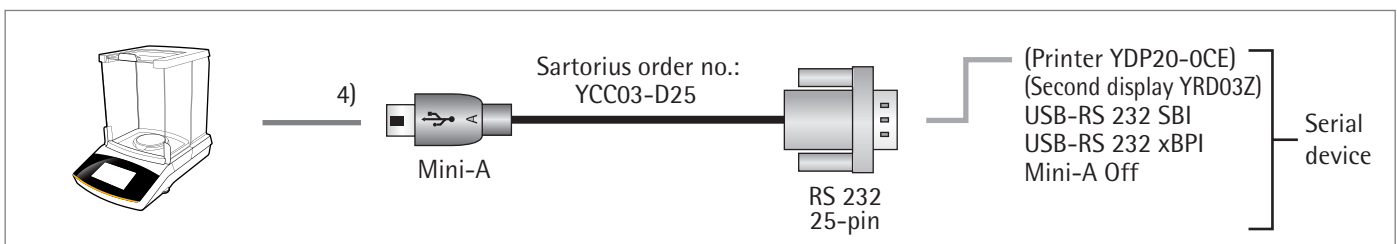

- ▶ Connect the peripheral device to the balance using the Sartorius YCC03-D25 connection cable (RS-232, 25-pin, Sartorius-specific assignment).
- ▶ Define the desired system settings:  
See "USB Port" on page "USB Port" on page 35.

## 10.3 Interface Specification

### 10.3.1 Data Output

You can define the data output parameter so that output is activated either when a manual print command is received or automatically synchronized with the display or at defined intervals (see application programs and autoprnt settings).

Data Output following Print Command    The print command can be transmitted by pressing the  key or by a software command (ESC P).

Automatic Data Output    In **Autoprnt** mode, data is output to the data interface port without an extra print command. You can have synchronized data output automatically or at defined intervals, with or without balance stability. If the automatic data output is activated in the Device Configuration, it starts immediately after the balance is turned on.

### 10.3.2 Data Output Formats

You can output the values with or without an identifier. The output format is configured in the device settings (see page 33).

Example: Output without ID    **+ 253 p c s**    (16 characters are printed, "SBI" mode only)

Example: Output with ID    **Q n t + 253 p c s**    (22 characters are printed, always with ID for printers and "PC text format")

#### Data Output Format with 16 Characters

Characters that are blank on the display are printed as spaces.  
Display values without a decimal point are printed without a decimal point.

#### Normal Operation

No.	1	2	3	4	5	6	7	8	9	10	11	12	13	14	15	16
	+	A	A	A	A	A	A	A	A	A	*	E	E	E	CR	LF
or	-		.	.	.	.	.	.	.	.		*	*	*		
or	*	*	*	*	*	*	*	*	*	*	*					

- \* Space
- A Displayed characters
- E Unit characters
- CR Carriage return
- LF Line feed
- . Decimal point or comma



### 10.3.3 Data Output Format with 22 Characters

When data is output in this format, ID codes with six characters will precede data. These characters identify the subsequent value.

#### Normal Operation

1	2	3	4	5	6	7	8	9	10	11	12	13	14	15	16	17	18	19	20	21	22
K	K	K	K	K	K	+	A	A	A	A	A	A	A	A	A	*	E	E	E	CR	LF
*	*	*	*	*	*	-	*	.	.	.	.	.	.	.	.	*	*	*	*		
							*	*	*	*	*	*	*	*	*						

K	Marking	CR	Carriage return
*	Space	LF	Line feed
A	Displayed characters	E	Unit characters (see "Conversion Factors for Weight Units" on page 42)

#### Example:

1	2	3	4	5	6	7	8	9	10	11	12	13	14	15	16	17	18	19	20	21	22
N						+	1	2	3	.	4	5	6	7	8	*	g	*	*	CR	LF
N						+	1	2	3	.	4	5	6	7	[	8	] <sup>1)</sup>	g	*	CR	LF

#### Special Outputs

1	2	3	4	5	6	7	8	9	10	11	12	13	14	15	16	17	18	19	20	21	22
S	t	a	t	*	*	*	*	*	*	*	*	-	-	*	*	*	*	*	*	CR	LF
												H	i	g	h						
												L	o	w							
												C	a	l	.	E	x	t	.		

*	Space	Cal.Int.	Internal adjustment
Low	Underweight	CR	Carriage return
High	Overload	LF	Line feed
Cal.Ext.	External adjustment		

#### Error message

1	2	3	4	5	6	7	8	9	10	11	12	13	14	15	16	17	18	19	20	21	22
S	t	a	t	*	*	*	*	*	E	r	r	*	#	#	#	*	*	*	*	CR	LF
									*	Space					###	Error number					

1) In settings "PC - SBI" and "USB RS-232 SBI" the non-verified display digit is not automatically identified. Corresponding measures or settings must be carried out on the peripheral device.

### 10.3.4 Data Input

#### Interface Commands

The computer connected via the data port can send commands to the balance to control the functions of the balance.

#### Formats for Control Commands (Syntax)

Format 1	Esc	!	CR	LF		
Format 2	Esc	!	#	_	CR	LF

Esc	Escape
!	Command character
#	Number
_	Underscore (ASCII: 95)
CR	Carriage return (optional)
LF	Line feed (optional)

#### Examples:

Format 1: Esc P

Format 2: Esc x1\_



### 10.3.5 Overview of Interface Commands

Format	Command	Action/Function	Note
1	ESC P	Print	Corresponding menu settings; with/without stability
1	ESC T	Tare or zero	
1	ESC K	Filter "Very stable conditions"	
1	ESC L	Filter "Stable conditions"	(Corresponds to "Stable" menu setting)
1	ESC M	Filter "Unstable conditions"	(Corresponds to "Unstable" menu setting)
1	ESC N	Filter "Very unstable conditions"	
1	ESC O	Block keys	
1	ESC Q	Acoustic signal	
1	ESC R	Unblock keys	
1	ESC S	Restart	
1	ESC Z	Internal calibration/adjustment	Depending on menu and model
1	ESC U	Tare	
1	ESC V	Zero	
1	ESC W	Ext. adjustment with standard weight (not available for verified models)	Depending on menu
2	ESC kP_	Print as with Print button	
2	ESC s3_	Go back, exit, cancel	
2	ESC x1_	Print balance type	
2	ESC x2_	Print serial number	
2	ESC x3_	Print balance software version	
2	ESC x4_	Print software version of display and control unit	
2	ESC x5_	Print user/device ID	





## 11. Status Messages

Messages appear on the display when certain events occur:

- Info messages are displayed for two seconds. The program then returns automatically to its original state.
- Error messages are displayed until they are acknowledged with a key.

### 11.1 Key Fadeout

To prevent operating errors, only relevant functions/keys are displayed depending on the situation. This prevents most operating errors from occurring. The following buttons are only available in specific circumstances:

	Only when there is a weight value within the zero setting range.
	Only when there is a weight value larger than zero, i.e., positive.
	Only when a peripheral device is connected and "Print" is not locked.
<b>CAL</b>	Only when calibration and adjustment functions are available and not locked.
<b>LEVEL</b>	Only when the balance has an electronic level indicator.
	Only when a weight value larger than zero is the value saved in the memory, if the value can be saved (e.g., value larger than SQmin).
<b>START</b>	Only when an application can be started (i.e., only when larger than zero and "Start" is permitted).

### 11.2 Application Error Messages

"Value is too small!"	When an entered value is too low for the parameter.
"Value is too large!"	When an entered value is too high for the parameter.
"Incorrect license code!"	When password protection is enabled and the code was entered incorrectly.
"Not able to increase identifier."	When the sample ID could not be assigned a number in ascending order automatically (as described in Chapter "Individual Identifiers").
"Not able to decrease identifier."	When the sample ID could not be assigned a number in descending order automatically (as described in Chapter "Individual Identifiers").

**Calibration/Adjustment Error Messages**

"The balance needs to be adjusted."	When isoCAL is required.
"The balance needs to be leveled."	When leveling is required.
"Weight is too light!"	When a weight that is too light is placed on the balance during external calibration.
"Weight is too heavy!"	When a weight that is too heavy is placed on the balance during external calibration.

**Leveling Error Messages**

"Level"	The balance must be leveled (for balances with electronic level indicators only).
---------	---

**Balance Maintenance Error Messages**

"Maintenance interval ended"	When the maintenance date set by Service has passed.
------------------------------	--

**Calibration Report Error Messages**

"Cal. data not saved"	When the 99 data records per day limit has been reached.
"Unable to read file"	When an error occurred when the file was being read.

**USB Device Error Message**

"The attached USB device is not supported."	When a USB device (printer) not made by Sartorius is connected.
---	---

## 12. Transporting the Balance

Please use the original packaging for shipping.  
Packaging can be ordered through the Sartorius Service Center if required.



Avoid glass breakage, shocks and vibrations:  
Never lift or carry the balance by its draft shield!



Prior to shipping, switch the balance to standby mode (see page 94) and then pull the power plug.

### 12.1 Detaching the Draft Shield/Weighing Pan

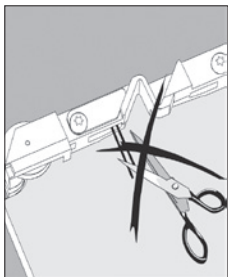

Danger of damage to the side panels!  
The guide carriages of the side panels are provided with fine steel filaments. Removal of these steel filaments or carrying out any other modifications to the guide carriages is forbidden.

- ▶ Press against the front of the cover from both sides and fold it upwards.
- ▶ Push the upper panel forwards and pull it out of the draft shield.
- ▶ Push the side panels slightly backwards and remove them from the draft shield.
- ▶ Pull the front panel over the groove of the draft shield and remove the panel.
- ▶ Pull the weighing pan out of the collection container.

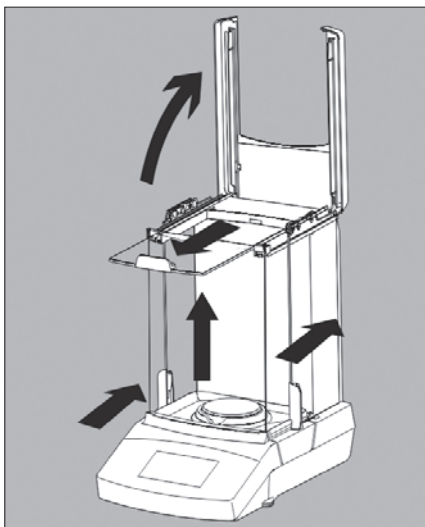

#### Secura® 26:

- ▶ Pull the weighing pan out of the collection container.
- ▶ Take the shield disk off the collection container.
- ▶ Remove the collection container.

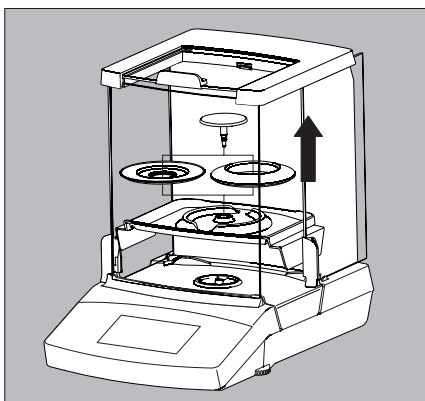

## 12.2 Packing the Balance

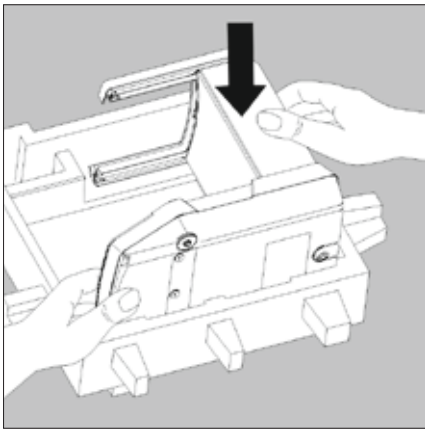

- ▶ Place the balance in the bottom part of the packaging.

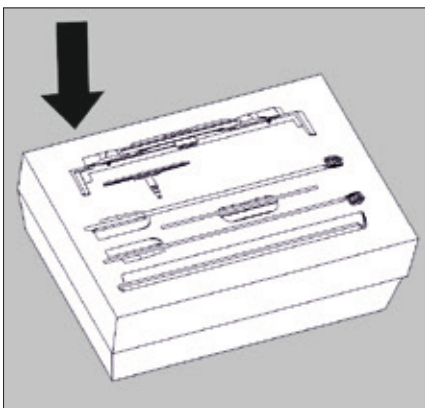

- ▶ Place the remaining components of the balance into the recesses provided in the packaging part:

- Collection container
- Weighing pan
- Right and left side panels
- Top panel
- Front panel
- Shield disks (Secura® 26 only)

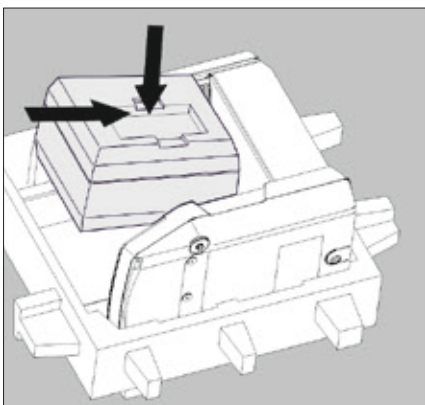

- ▶ Seal the packaging part with the components and place in the recess provided.

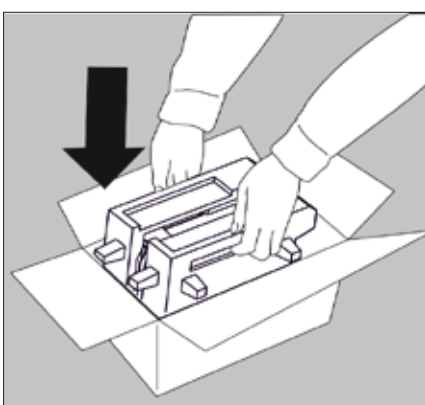

- ▶ Put the top part of the packaging over the device parts.
- ▶ Next, put the packaged balance into the cardboard box and seal the box.

## 13. Care and Maintenance

### 13.1 Service

To ensure the continued accuracy of your balance, we recommend scheduling regular servicing at least once a year. The Sartorius Service Center offers different service contracts for this purpose, which can be individually adapted to suit your needs (see also [www.sartorius.com/service](http://www.sartorius.com/service)). A calibration certificate should always be issued as part of every maintenance session. Safety inspections of the AC adaptor and its connections must be performed at appropriate intervals by a qualified electrician (e.g., every 2 years).



#### Repairs

Repair work must only be carried out by trained service technicians. The device must be unplugged during repair work. Unplug from the mains power. In addition, the measurement accuracy of your balance may be affected and serious risks to the user may occur. Contact Sartorius Service or a Sartorius dealer for proper repairs.

### 13.2 Cleaning the Balance

#### Cleaning the Control Panel

Switch the display to standby mode to avoid modifying the settings for operation during cleaning.



- ▶ Select the menu key to switch to the application selection.



- ▶ If you then select , the display is switched off.



- ▶ To switch the display back on: Select  at the bottom left of the display. The balance starts in the application most recently used before the it was last switched off.

## Cleaning the Balance Housing



### Contaminated Equipment:

- Health risk from product contamination due to product deposits and the collection of residue with microbial contamination.
- Health risk from biological or microbiological substances.
- Observe cleaning specifications.
- Examine the cleaning results closely.



- ▶ Disconnect the equipment from the AC power: Disconnect the AC adapter from the power supply.  
Disconnect any data cable connected to the balance.



Never open the balance or the AC adapter.  
The parts contained in these cannot be cleaned, repaired or replaced by the operator.

- Make sure that no liquid or dust gets into the balance or the AC adapter.
- Never use cleaning agents that contain solvents or abrasive ingredients, which can ultimately damage the equipment.  
Secura® and Quintix® models:



Do not clean the following parts with acetone or aggressive cleaning agents:  
Control panel, mains plug, data interface, labels, verified seal and all other plastic parts.

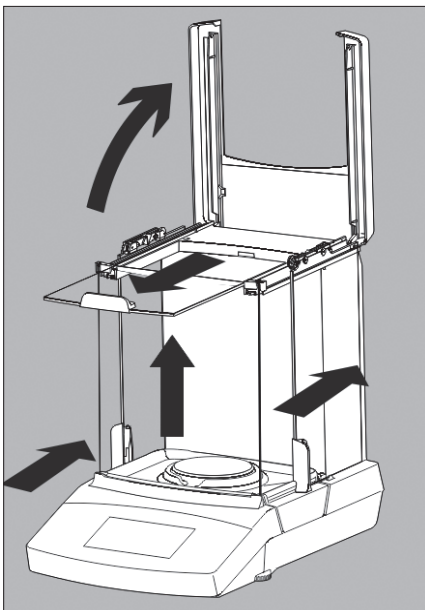

- ▶ Press against the front of the cover from both sides and fold it upwards.
- ▶ Push the upper panel forwards and pull it out of the draft shield.
- ▶ Push the side panels slightly backwards and remove them from the draft shield.
- ▶ Pull the front panel over the groove on the bottom of the draft shield and remove the panel.

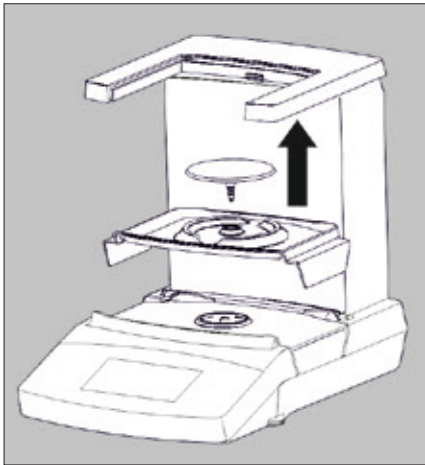

- ▶ Pull the weighing pan out of the collection container.
- ▶ Remove the collection container.

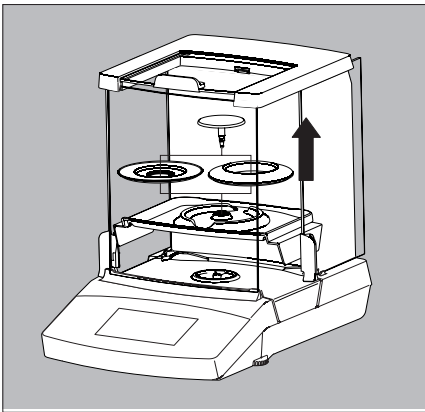

**Secura® 26**

- ▶ Pull the weighing pan out of the collection container.
- ▶ Take the shield disk off the collection container.
- ▶ Remove the collection container.



You can also remove the collection container without taking out the panels. To do so, open the side panels, tilt the collection container, and carefully pull it out through the open side panels.



If required, remove the rear panel for cleaning.

- ▶ Press the locking mechanism above the rear panel upwards and remove the rear panel.
- ▶ Clean the housing/panels and then dry the balance with a soft cloth.
- ▶ After cleaning put together the components in reverse order:
  - Reinsert the rear panel. Ensure that this engages in the locking mechanism above the rear panel.
  - Follow the instructions in Chapter "Installing the Balance" on page 10.



## 14. Disposal



The packaging is made from environmentally-friendly materials that can be used as secondary raw materials. Packaging that is no longer needed can be disposed of in Germany free of charge via the VfW Dual System (contract number D-59101-2009-1129). Otherwise, dispose of the material at your local waste management facility according to the applicable regulations. The device, including accessories and batteries, must not be disposed of in general household waste and must be recycled similar to electrical and electronic devices. For disposal or recycling, please contact our service staff on-site. In addition, the partners listed on the following website are available within the EU:

- 1) Select <http://www.sartorius.com>.
- 2) Select the "Services" tab.
- 3) Then select "Disposal Information."
- 4) Addresses for the local Sartorius disposal contacts can be found in the PDF files available for download on this page.



Sartorius will not take back equipment contaminated with hazardous materials (ABC contamination) – either for repair or disposal.

### **Service Address for Disposal:**

Detailed information, including service addresses for returning your device for repair or disposal, can be found on our website ([www.sartorius.com](http://www.sartorius.com)) or requested from a Sartorius Service Center.

# 15. Specifications

## 15.1 General Data

Specification	Unit	Value
<b>AC adapter</b>		
Sartorius AC Adapter		YEPS01-PS4 or YEPS01-PS5 with replaceable country-specific power plug adapters
Primary		100 – 240 V~, ± 10 %. 50 – 60 Hz ± 5 %, 0.2 A
Secondary		15 V <sub>DC</sub> , ± 5%, 530 mA (max.) / 8 Watt (max.): 0°C to +40°C 15 V <sub>DC</sub> , ± 5%, 330 mA (max.) / 5 Watt (max.): +40°C to +50°C
Further details		Protection class II in accordance with EN/IEC 60950-1   up to 3000 m above sea level IP40 in accordance with EN 60529/IEC 60529
<b>Balance</b>		
Supply voltage		Only via Sartorius AC adapter YEPS01-PS4 or YEPS01-PS5 with replaceable country-specific power plug adapters
Power consumption	W	4.5 (typically)
Further details		IP43 in accordance with EN 60529/IEC 60529
<b>Ambient conditions</b>		
The technical data apply under the following ambient conditions:		
Environment		For indoor use only
Ambient temperature*	°C	+10 to +30
Operational capability	°C	Guaranteed between +5 and +45.
Storage and shipping	°C	-10 to +60
Height above sea level (NN)	m	Up to 3000
Relative humidity**		15 – 80% for temperatures up to 31°C non-condensing, decreasing linearly up to 50% relative humidity at 40°C and 20% at 50°C.
<b>Safety of Electrical Equipment</b>		In accordance with EN 61010-1/IEC 61010-1 Safety requirements for electrical equipment for measurement, control and laboratory use – Part 1: General requirements
<b>Electromagnetic Compatibility</b>		In accordance with EN 61326-1/IEC 61326-1 Electrical equipment for measurement, control and laboratory use – EMC requirements – Part 1: General requirements
Interference resistance		Suitable for use in industrial areas
Transient emissions		Class B Suitable for use in residential areas and areas that are connected to a low voltage network that also supplies residential buildings.
<b>Standard Equipment</b>		
Selectable weight units <sup>1</sup>		Gram, kilogram, carat, pound, ounce, troy ounce, Hong Kong tael, Singapore tael, Taiwanese tael, grain, pennyweight, milligram, parts per pound, Chinese tael, momme, Austrian carat, tola, baht, mesghal and Newton
Available application programs		<b>Secura® models:</b> Counting, percentage, density determination, peak hold, unstable condition, checkweighing, mixing, components (totalizing), statistics, conversion, SQmin, and identifiers <b>Quintix® models:</b> Counting, percentage, density determination, peak hold, unstable condition, checkweighing, mixing, components (totalizing), statistics, conversion

**M** Verified balances in accordance with EU requirements comply with the requirements of Council Directive 2009/23/EC with EN 45501:1992 and OIML R76:2006.

\* For verified balances in accordance with EU requirements, refer to the information on the balance.

\*\* For verified balances in accordance with EU requirements, the legal regulations apply.

<sup>1</sup> Depending on the country-specific model version, not all weight units listed may be available.

## FCC Rules

### Safety Precautions:

NOTE: This equipment has been tested and found to comply with the limits for a Class B digital device, pursuant to part 15 of the FCC Rules. These limits are designed to provide reasonable protection against harmful interference in a residential installation. This equipment generates, uses and can radiate radio frequency energy and, if not installed and used in accordance with the instructions, may cause harmful interference to radio communications. However, there is no guarantee that interference will not occur in a particular installation. If this equipment does cause harmful interference to radio or television reception, which can be determined by turning the equipment off and on, the user is encouraged to try to correct the interference by one or more of the following measures:

- Reorient or relocate the receiving antenna.
- Increase the separation between the equipment and receiver.
- Connect the equipment into an outlet on a circuit different from that to which the receiver
- Consult the dealer or an experienced radio/TV technician for help.

### Shielded Cables:

Connections between the devices and peripherals must be made using shielded cables in order to maintain compliance with FCC radio frequency emission limits.

### Modifications:

Any modifications made to this devices that are not approved by Sartorius Lab Instruments GmbH & Co. KG may void the authority granted to the user by the FCC to operate this equipment.

## 15.2 Model-specific Data

		Secura®			
Model		26-1x <sup>1)</sup>	225D-1x <sup>1)</sup>	125-1x <sup>1)</sup>	324-1x <sup>1)</sup>
Weighing capacity	g	21	60 / 120 / 220	60 / 120	320
Readability	mg	0.002	0.01 / 0.01 / 0.1	0.01 / 0.01	0.1
Repeatability (standard deviation)	mg	0.004	0.03 / 0.04 / 0.07	0.03 / 0.04	0.1
Repeatability (standard deviation), typical	mg	0.003	0.02 / 0.04 / 0.07	0.02 / 0.04	0.1
Linearity deviation	mg	0.01	0.1 / 0.1 / 0.2	0.1 / 0.1	0.3
Min. initial weight according to USP, typical	mg	4	40	40	160
Sensitivity drift between +10 to +30°C	± ppm/K	1	1	1	1
Typical stabilization time	s	8	6 / 6 / 2	6	2
isoCAL:					
- Temperature change	K	1.5	1.5	1.5	1.5
- Time interval	h	4	4	4	4
Display result (depending on the set filter level)	s	0.2 / 0.4	0.2 / 0.4	0.2 / 0.4	0.2 / 0.2
Weighing pan size	mm	∅ 50	∅ 80 (∅ 90 optional)	∅ 80 (∅ 90 optional)	∅ 90
Weighing chamber height*	mm	218	218	218	218
Net weight, approx.	kg	8.0	7.8	7.8	7.9

		Quintix®		
Model		125D-1x <sup>1)</sup>	65-1x <sup>1)</sup>	35-1x <sup>1)</sup>
Weighing capacity	g	40 / 60 / 120	40 / 60	30
Readability	mg	0.01 / 0.01 / 0.1	0.01 / 0.01	0.01
Repeatability (standard deviation)	mg	0.03 / 0.04 / 0.07	0.03 / 0.04	0.03
Repeatability (standard deviation), typical	mg	0.02 / 0.04 / 0.07	0.02 / 0.04	0.03
Linearity deviation	mg	0.1 / 0.1 / 0.2	0.1 / 0.1	0.1
Sensitivity drift between +10 to +30°C	± ppm/K	1	1	1
Typical stabilization time	s	6 / 6 / 2	6	6
isoCAL:				
- Temperature change	K	1.5	1.5	1.5
- Time interval	h	4	4	4
Display result (depending on the set filter level)	s	0.2 / 0.4	0.2 / 0.4	0.2 / 0.4
Weighing pan size	mm	∅ 80 (∅ 90 optional)	∅ 80 (∅ 90 optional)	∅ 80 (∅ 90 optional)
Weighing chamber height*	mm	218	218	218
Net weight, approx.	kg	7.8	7.8	7.8

\* Upper edge of the weighing pan to the lower edge of the upper draft shield panel

<sup>1)</sup> Possible terms for country-specific models:

x = S: Standard balances without country-specific additions

x = SAR: Standard balances with country-specific additions for Argentina

x = SJP: Standard balances with country-specific additions for Japan

x = SKR: Standard balances with country-specific additions for South Korea

## 15.3 Verified Models with Country-specific Type Approval Certificate

		Secura®			
Model		26-1x <sup>1)</sup>	225D-1x <sup>1)</sup>	125-1x <sup>1)</sup>	324-1x <sup>1)</sup>
Accuracy class		Ⓢ	Ⓢ	Ⓢ	Ⓢ
Type <sup>2)</sup>		SQP-H	SQP-F	SQP-F	SQP-G
Max	g	21	120 / 220	120	320
Scale interval d	g	0.000002	0.00001 / 0.0001	0.00001	0.0001
Verification scale interval e	g	0.001	0.001	0.001	0.001
Min	g	0.001	0.001	0.001	0.01
Min (only for Models ...-10IN)	g	-	0.1	0.1	0.1
Tare equalization range (subtractive)		< 100% from max. weighing capacity			
Min. initial weight according to USP, typical	mg	4	40	40	160
Typical stabilization time	s	8	6 / 2	6	2
isoCAL:					
- Temperature change	K	1.5	1.5	1.5	1.5
- Time interval	h	4	4	4	4
Display result (depending on the set filter level)	s	0.2 / 0.4	0.2 / 0.4	0.2 / 0.4	0.2 / 0.2
Weighing pan size	mm	∅ 50	∅ 80 (optional d 90)	∅ 80 (optional d 90)	∅ 90
Weighing chamber height*	mm	218	218	218	218
Net weight, approx.	kg	8.0	7.8	7.8	7.9

<sup>1)</sup> Possible terms for country-specific models:

x = CEU: Verified balances with EC Type Approval Certificate D12-09-014 without country-specific additions

x = CFR: Verified balances with EC Type Approval Certificate D12-09-014 for France only

x = CIT: Verified balances with EC Type Approval Certificate D12-09-014 for Italy only

x = CCH: Verified balances with EC Type Approval Certificate D12-09-014 for Switzerland only

x = CN: CMC Type Approval Certificate for China

x = OJP: Balance with Type Approval Certificate for Japan

x = OBR: Balance with Type Approval Certificate for Brazil

x = ORU: Balance with Type Approval Certificate for Russia

x = OIN: Balance with Type Approval Certificate for India

<sup>2)</sup> all Models ...CN: Type "SQP"

\* Upper edge of the weighing pan to the lower edge of the upper draft shield panel

		Quintix®		
Model		125D-1x <sup>1)</sup>	65-1x <sup>1)</sup>	35-1x <sup>1)</sup>
Accuracy class		Ⓢ	Ⓢ	Ⓢ
Type <sup>2)</sup>		SQP-F	SQP-F	SQP-F
Max	g	60 / 120	60	30
Scale interval d	g	0.00001 / 0.0001	0.00001	0.00001
Verification scale interval e	g	0.001	0.001	0.001
Min	g	0.001	0.001	0.001
Min (only for Models ...-10IN)	g	0.1	0.1	0.1
Tare equalization range (subtractive)		< 100% from max. weighing capacity		
Typical stabilization time	s	6 / 2	6	6
isoCAL:				
- Temperature change	K	1.5	1.5	1.5
- Time interval	h	4	4	4
Display result (depending on the set filter level)	s	0.2 / 0.4	0.2 / 0.4	0.2 / 0.4
Weighing pan size	mm	∅ 80 (optional ∅ 90)	∅ 80 (optional ∅ 90)	∅ 80 (optional ∅ 90)
Weighing chamber height*	mm	218	218	218
Net weight, approx.	kg	7.8	7.8	7.8

1) Possible terms for country-specific models:

x = CEU: Verified balances with EC Type Approval Certificate D12-09-014 without country-specific additions

x = CFR: Verified balances with EC Type Approval Certificate D12-09-014 for France only

x = CIT: Verified balances with EC Type Approval Certificate D12-09-014 for Italy only

x = CCH: Verified balances with EC Type Approval Certificate D12-09-014 for Switzerland only

x = CN: CMC Type Approval Certificate for China

x = OJP: Balance with Type Approval Certificate for Japan

x = OBR: Balance with Type Approval Certificate for Brazil

x = ORU: Balance with Type Approval Certificate for Russia

x = OIN: Balance with Type Approval Certificate for India

2) all Models ...CN: Type "SQP"

\* Upper edge of the weighing pan to the lower edge of the upper draft shield panel

## 15.4 Accessories

### General Information

Set of rechargeable batteries for standard laboratory balances	YRB11Z
In-use dust cover	6960MA03
Dust cover	6960SE04
Weighing pan 80 mm, slotted	YSP01SQP
Weighing pan 90 mm, incl. retrofitting kit	YWP01SQP
Filter weighing pan 130 mm	YFW01SQP
Round glass draft shield	YHK01SQP
USP Minimum sample weight certificate	84CGNA

### Printers and Communication

Premium GLP Laboratory Printer	YDP30
– Printer paper for GLP lab printer	69Y03285
– Continuous labels GLP lab printer	69Y03286
Standard lab printer	YDP40
– Printer paper for lab printer	69Y03287
Data cable for Mini USB/USB A	YCC04-D09
Data cable for Mini USB/9-pin RS-232	YCC03-D09
Data cable for Mini USB/25-pin RS-232	YCC03-D25

### Density Determination

Density determination kit	YDK05, available upon request
---------------------------	-------------------------------------

### Calibration Weights

Calibration weight for lab balance type 26 Proof Line knob weight 20 g, OIML Class E2, with DAkkS certificate	YCW422-AC-02
Calibration weight for lab balance type 225 / 324 Proof Line knob weight 200 g, OIML Class E2, with DAkkS certificate	YCW522-AC-02
Calibration weight for lab balance type 125 Proof Line knob weight 100 g, OIML Class E2, with DAkkS certificate	YCW512-AC-02
Calibration weight for lab balance type 65 Proof Line knob weight 50 g, OIML Class E2, with DAkkS certificate	YCW452-AC-02
Calibration weight for lab balance type 35 Proof Line knob weight 20 g, OIML Class E2, with DAkkS certificate	YCW422-AC-02

## 15.5 Balance Dimensions

### 15.5.1 Secura®, Quintix®

35, 65, 125, 125D, 225D, 324

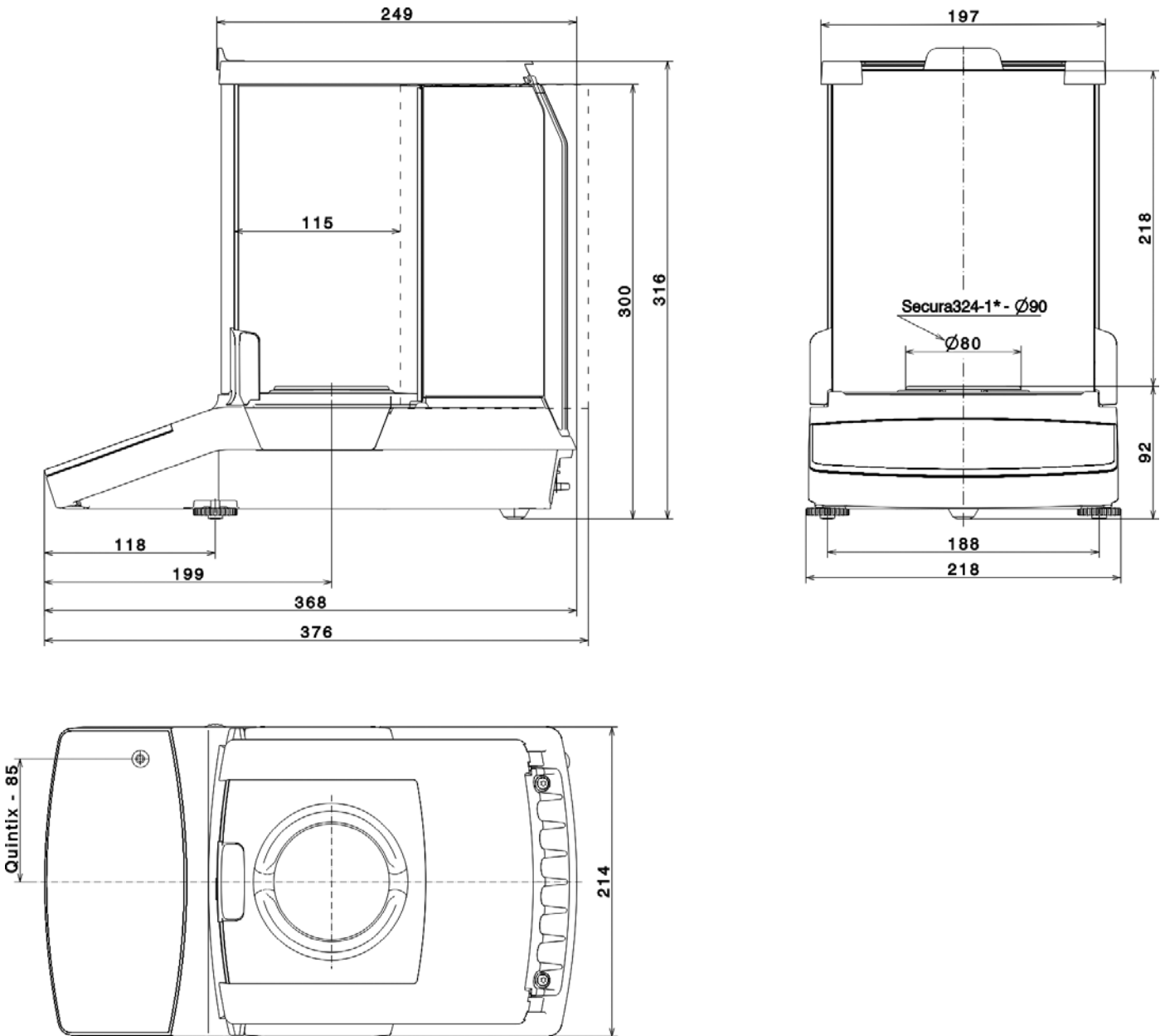

All dimensions are given in millimeters



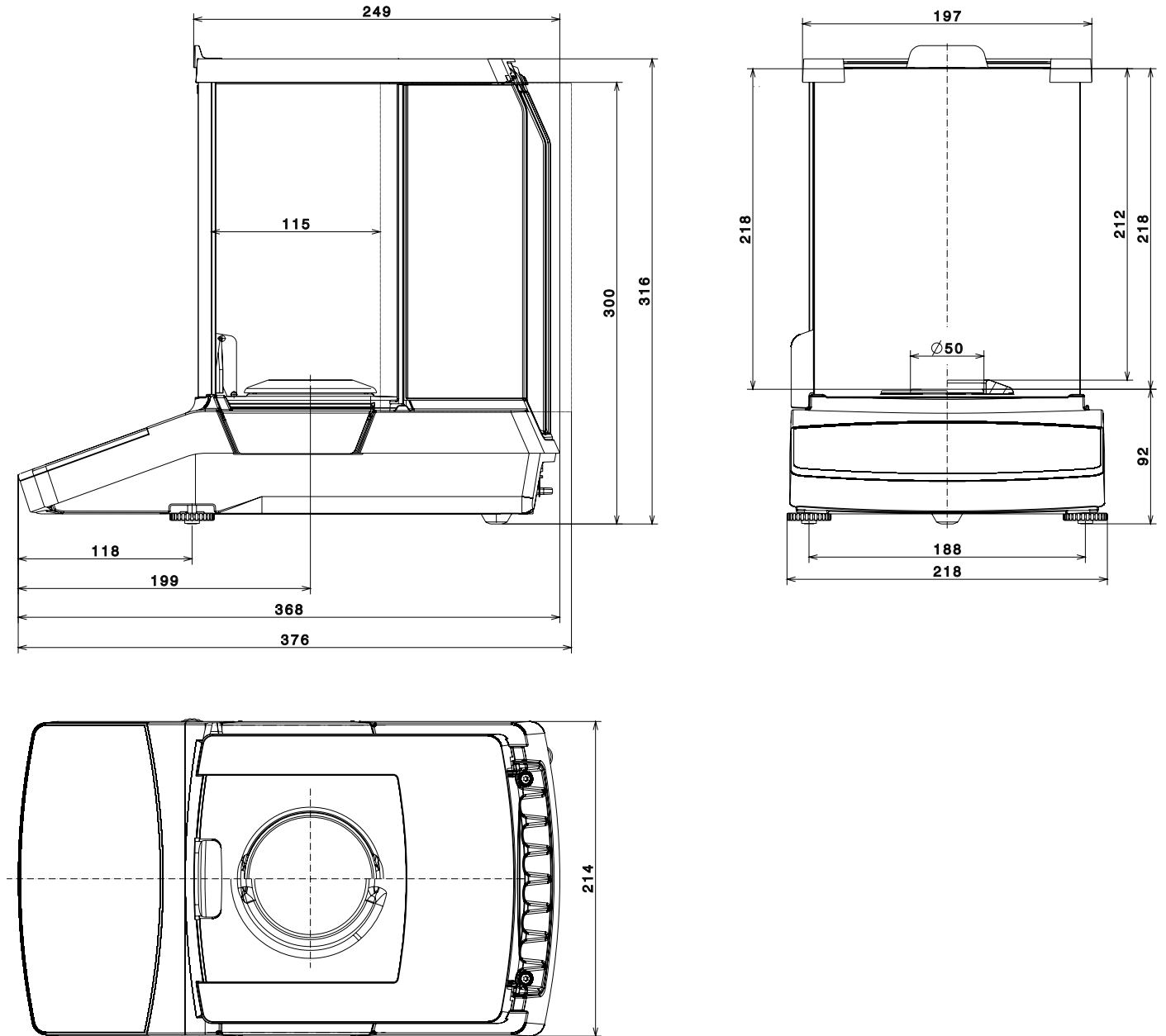

## 15.5.2 Secura® 26



All dimensions are given in millimeters

## Appendix

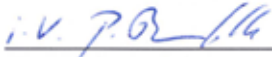
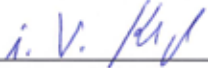
Original		
		
<b>EG-/EU-Konformitätserklärung</b> <b>EC / EU Declaration of Conformity</b>		
<b>Hersteller</b> <i>Manufacturer</i>	Sartorius Lab Instruments GmbH & Co. KG 37070 Goettingen, Germany	
	erklärt in alleiniger Verantwortung, dass das Betriebsmittel <i>declares under sole responsibility that the equipment</i>	
<b>Geräteart</b> <i>Device type</i>	Elektronische Laborwaage <i>Electronically laboratory balance</i>	
<b>Baureihe</b> <i>Type series</i>	SECURAx-1yz, QUINTIXx-1yz, PRACTUMx-1yz, PRACTUMx-1X01 x = 26, 35, 64, 65, 124, 125, 125D, 213, 224, 225D, 313, 324, 412, 513, 612, 613, 1102, 1103, 2101, 2102, 3101, 3102, 5100, 5101, 5102, 6100, 6101, 6102; y = C, N, O, S; z = AR, AU, BR, CA, CN, IN, JP, KR, N, RU, US oder leer   <i>or blank</i>	
	in der von uns in Verkehr gebrachten Ausführung allen einschlägigen Bestimmungen der folgenden Europäischen Richtlinien - einschließlich deren zum Zeitpunkt der Erklärung geltenden Änderungen - entspricht und die anwendbaren Anforderungen folgender harmonisierter Europäischer Normen erfüllt: <i>in the form as delivered fulfils all the relevant provisions of the following European Directives - including any amendments valid at the time this declaration was signed - and meets the applicable requirements of the harmonized European Standards listed below:</i>	
2014/30/EU	Elektromagnetische Verträglichkeit   <i>Electromagnetic compatibility</i> EN 61326-1:2013	
2011/65/EU	Beschränkung der Verwendung bestimmter gefährlicher Stoffe in Elektro- und Elektronikgeräten (RoHS) <i>Restriction of the use of certain hazardous substances in electrical and electronic equipment (RoHS)</i> EN 50581:2012	
2014/35/EU	Elektrische Betriebsmittel zur Verwendung innerhalb bestimmter Spannungsgrenzen <i>Electrical equipment designed for use within certain voltage limits</i> EN 61010-1:2010 Statt 2014/35/EU für   <i>instead of 2014/35/EU for</i> SECURAx-1yz, QUINTIXx-1yz, PRACTUMx-1CN, PRACTUMx-1OBR, PRACTUMx-1OIN, PRACTUMx-1ORU:	
2006/42/EG 2006/42/EC	Maschinen <i>Machines</i> EN ISO 12100:2010, EN 61010-1:2010 Die Person, die bevollmächtigt ist, die technischen Unterlagen zusammenzustellen: <i>The person authorised to compile the technical file:</i> Sartorius Lab Instruments GmbH & Co. KG International Certification Management 37070 Goettingen, Germany	
	Jahreszahl der CE-Kennzeichenvergabe   <i>Year of the CE mark assignment:</i> <b>16</b>	
	Sartorius Lab Instruments GmbH & Co. KG Goettingen, 2016-04-20	
	 Dr. Reinhard Baumfalk Vice President R&D	 Dr. Dieter Klausgrete Head of International Certification Management
	Diese Erklärung bescheinigt die Übereinstimmung mit den genannten EG- und EU-Richtlinien, ist jedoch keine Zusicherung von Eigenschaften. Bei einer mit uns nicht abgestimmten Änderung des Produktes verliert diese Erklärung ihre Gültigkeit. Die Sicherheitshinweise der zugehörigen Produktdokumentation sind zu beachten. <i>This declaration certifies conformity with the above mentioned EC and EU Directives, but does not guarantee product attributes. Unauthorised product modifications make this declaration invalid. The safety information in the associated product documentation must be observed.</i>	
	Doc: 2003687-02 SLI13CE001-02.de,en 1 / 1 PMF: 2018167 OP-113_fo1_2015.10.12	

M

The declaration of conformity supplied here is for verified balances for use in the EEA.  
Please keep it in a safe place.



**Physikalisch-Technische Bundesanstalt**  
**Braunschweig und Berlin**  
 Nationales Metrologieinstitut



## EG-Bauartzulassungsbescheinigung

*EC Type-approval Certificate*

<b>Ausgestellt für:</b> <i>Issued to:</i>	Sartorius Lab Instruments GmbH & Co. KG Weender Landstr. 94-108 37075 Göttingen	
<b>gemäß:</b> <i>In accordance with:</i>	Anhang II Nr. 1. der Richtlinie 2009/23/EG des Europäischen Parlaments und des Rates vom 23. April 2009 über nichtselbsttätige Waagen (ABl. L 122 S. 6) <i>Annex II No 1 of the Directive 2009/23/EC of the European Parliament and of the Council of 23 April 2009 on non-automatic weighing instruments (OJ L 122 p. 6)</i>	
<b>Geräteart:</b> <i>Type of instrument:</i>	Nichtselbsttätige elektromechanische Präzisionswaage <i>Non-automatic electromechanical high accuracy weighing instrument</i>	
<b>Typbezeichnung:</b> <i>Type designation:</i>	SQP-...	
<b>Nr. der Bescheinigung:</b> <i>Certificate No.:</i>	D12-09-014, Revision 3	
<b>Gültig bis:</b> <i>Valid until:</i>	30.09.2022	
<b>Anzahl der Seiten:</b> <i>Number of pages:</i>	16	
<b>Geschäftszeichen:</b> <i>Reference No.:</i>	PTB-1.12-4071367	
<b>Notifizierte Stelle:</b> <i>Notified Body:</i>	0102	
<b>Zertifizierung:</b> <i>Certification:</i>	Braunschweig, 03.02.2015	<b>Bewertung:</b> <i>Evaluation:</i>
<b>Im Auftrag</b> <i>On behalf of PTB</i>	<b>Siegel</b> <i>Seal</i>	<b>Im Auftrag</b> <i>On behalf of PTB</i>

Dr. Oliver Mack



Dr. Tobias Klein

EG-Bauartzulassungsbescheinigungen ohne Unterschrift und Siegel haben keine Gültigkeit. Diese EG-Bauartzulassungsbescheinigung darf nur unverändert weiterverbreitet werden. Auszüge bedürfen der Genehmigung der Physikalisch-Technischen Bundesanstalt.

*EC Type-approval Certificates without signature and seal are not valid. This EC Type-approval Certificate may not be reproduced other than in full. Extracts may be taken only with the permission of the Physikalisch-Technische Bundesanstalt.*



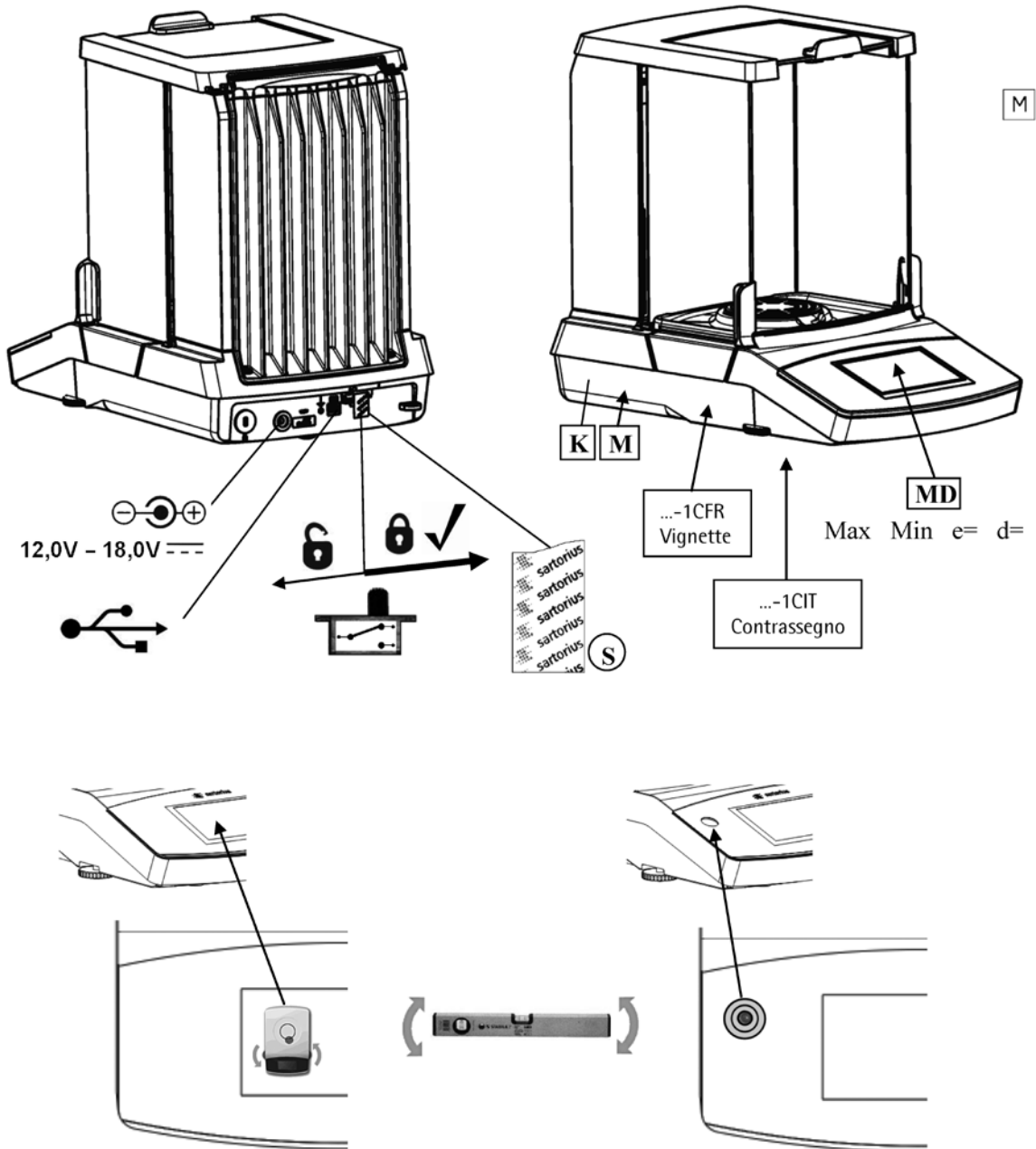

R3-0023

Schilder und Marken / Plates and Markings / Plaques et marques /  
Placas y Marcas / Etichette e Sigilli



Typ Waage / Type weighing instrument / Type d'instrument de pesage / Tipo del instrumento de pesaje / Tipo di strumento per pesare:  
SQP-F, SQP-G, SQP-H  
EG Bauartzulassung / EC type-approval certificate / Certificat d'approbation CE de type / Certificado de aprobación CE de tipo /  
Certificato di Approvazione CE del Tipo: D12-09-014

PPFG070116

- K** Kennzeichnungsschild mit CE-Zeichen / Descriptive plate with CE-sign / Plaque d'identification avec marque CE de conformité / Placa de características con la marca CE / Etichetta d'identificazione con marchio CE
- M** CE-Kennzeichnung und zusätzliche Metrologie- Kennzeichnung: M und Jahr des Konformitätsbewertungsverfahrens (Anbringung der CE-Kennzeichnung) und die Kennnummer der notifizierten Stelle / CE marking and the additional metrology marking: M and year of conformity assessment procedure (affixing of CE marking) and the identification number of the notified body / Marcado CE y marcado adicional de metrología: M y año del procedimiento de la evaluación de la conformidad (imposición de la marca CE) y el número de identificación del organismo notificado / Marquage CE et marquage métrologique supplémentaire: M et année de la procédure d'évaluation de la conformité (apposition du marquage CE) et le numéro d'identification de l'organisme notifié / Marcatura CE e marcatura metrologica supplementare: M e anno della procedura di valutazione della conformità (apposizione della marcatura CE) e il numero del organismo notificato
- S** Sicherungsstempel (selbstklebende Marke oder Plombe) / Protective mark (self-adhesive mark or seal) / Marque de protection (marque ou sceau autocollant) / Sello de seguridad (marca autoadhesiva o precinto) / Sigillo di protezione (bollino autoadesivo o piombo)
- MD** Metrologische Daten Max, Min, e und wenn vorhanden d / Metrological data Max, Min, e and if existent d / Données métrologiques : Max, Min, e et, si disponible, d / Datos metroológicos: Máx, Mín, e y d, si está disponible / Dati metrologici: Max, Min, e, e d se disponibile
-  Programmverriegelungsschalter / Menu access switch / Commutateur d'accès au menu / Interruptor de bloqueo de programa / Commutatore di accesso al menu
-  gesperrt / locked / verrouillé / bloqueado / bloccato
-  USB Schnittstelle / USB interface / Interface USB / Interfaz USB / Interfaccia USB
-  Spannungsversorgung / Power supply / Alimentation / Fuente de alimentación / Alimentazione

Beispiel für Kennzeichnungsschild der bereits geeichten Waage **K**  
Example of descriptive plate on a weighing instrument already verified  
Exemple de plaque d'identification d'une balance vérifiée  
Ejemplo de rótulo de características del instrumento de pesaje ya verificado  
Esempio di etichetta d'identificazione dello strumento per pesare già omologato

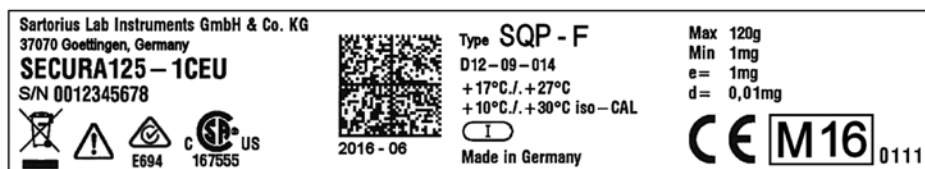

Typ Waage / Type weighing instrument / Type d'instrument de pesage / Tipo del instrumento de pesaje / Tipo di strumento per pesare:  
 SQP-F, SQP-G, SQP-H  
 EG Bauartzulassung / EC type-approval certificate / Certificat d'approbation CE de type / Certificado de aprobación CE de tipo /  
 Certificato di Approvazione CE del Tipo: D12-09-014

PPFG070116



# Certificate of Compliance

**Certificate:** 2497246 **Master Contract:** 167555 (056628\_0\_000)

**Project:** 70130821 **Date Issued:** 2017-04-28

**Issued to:** Sartorius Lab Instruments GmbH & Co. KG  
Otto-Brenner-Strasse 20  
Goettingen, 37079  
GERMANY

*The products listed below are eligible to bear the CSA Mark shown with adjacent indicators 'C' and 'US' for Canada and US or with adjacent indicator 'US' for US only or without either indicator for Canada only.*



**Issued by:** *Kim Ngan Nguyen*  
Kim Ngan Nguyen

## **PRODUCTS**

CLASS - C872105 - LABORATORY EQUIPMENT-Electrical

CLASS - C872185 - ELECTRICAL EQUIPMENT FOR LABORATORY USE-Certified to US Standards

Laboratory Scales, Practum, Quintix and Secura, Models AAAAAAABBBB-CDDD, rated: 15 Vdc, 3 W

(max.).

High Resolution Laboratory Scale Series models Quintix..... and Secura....., rated: 15 Vdc, 4.5 W (max.).

### Notes:

1. The external AC Adapter for use with the above models is considered Equipment Class II, Pollution Degree 2.
2. To be used with external AC Adapter (Sartorius part 6971790), UL approved (120 Vac) and manufactured by FRIWO GERAETEBAU GMBH (type 153779). Rated output 15 Vdc, 530 mA.  
The equipment can also be used with any other power supply approved for Canada and USA under the 60950-1 standard and which provides Reinforced insulation between mains and secondary circuits. It must be rated for 3000m and up to 50°C and must provide an output of 15Vdc with a minimum of 300mA.
3. The above Laboratory scales were evaluated for 50 C ambient, 3000 m elevation.



**Certificate:** 2497246  
**Project:** 70130821

**Master Contract:** 167555  
**Date Issued:** 2017-04-28

**APPLICABLE REQUIREMENTS**

CAN/CSA-C22.2 No. 61010-1-04

UL Std. No. 61010-1 (2nd Edition)

Safety Requirements for Electrical Equipment for Measurement,  
Control, and Laboratory Use, Part 1: General Requirements  
Safety Requirements for Electrical Equipment for Measurement,  
Control, and Laboratory Use - Part 1: General Requirements



### *Supplement to Certificate of Compliance*

**Certificate:** 2497246

**Master Contract:** 167555 (056628\_0\_000)

*The products listed, including the latest revision described below, are eligible to be marked in accordance with the referenced Certificate.*

#### **Product Certification History**

<b>Project</b>	<b>Date</b>	<b>Description</b>
70130821	2017-04-28	CSA c/us report update (2497246) for modifying the external AC Adapter detail of Laboratory Scales, Practum, Quintix and Secura, Models AAAAAAABBBB-CDDD and High Resolution Laboratory Scale Series models Quintix....-..... and Secura....-.....
2757579	2014-10-15	Update to Report to cover new models - high resolution scales Secura and Quintix, addition of Peltier element, new PCB and TFT display.
2604694	2013-02-22	Report correction - model name from Quintex to Quintix.
2497246	2012-04-13	CSA Certification (c us Mark) for Scales Secura, Quintex and Practum.



Sartorius Lab Instruments GmbH & Co. KG  
Otto-Brenner-Strasse 20  
37079 Goettingen, Germany

Phone: +49.551.308.0  
Fax: +49.551.308.3289  
www.sartorius.com

The information and figures contained in these instructions correspond to the version date specified below.

Sartorius reserves the right to make changes to the technology, features, specifications and design of the equipment without notice.

Masculine or feminine forms are used to facilitate legibility in these instructions and always simultaneously denote the other gender as well.

**Copyright notice:**

This instruction manual, including all of its components, is protected by copyright. Any use beyond the limits of the copyright law is not permitted without our approval. This applies in particular to reprinting, translation and editing irrespective of the type of media used.

© Sartorius Germany

Last updated:  
08 | 2017