

Valid for Item-No.: 651101, 651160, 651161, 651180

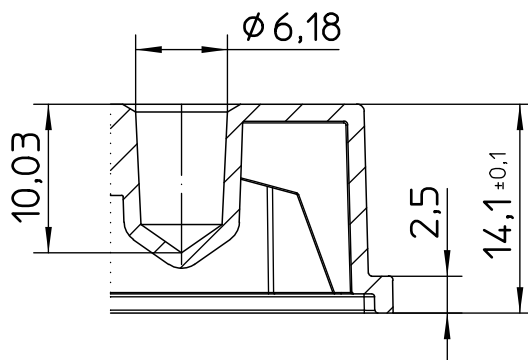

Curvature max.0,2

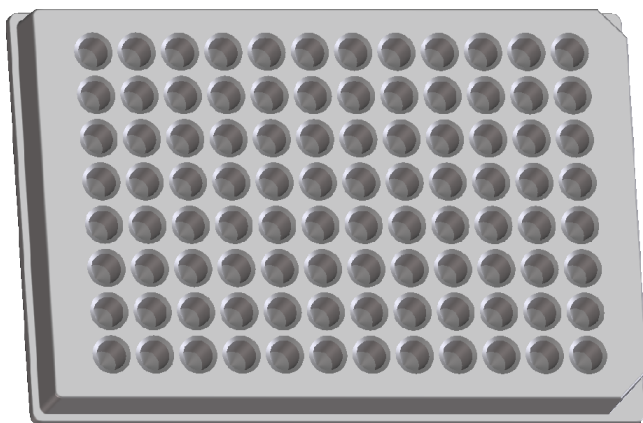
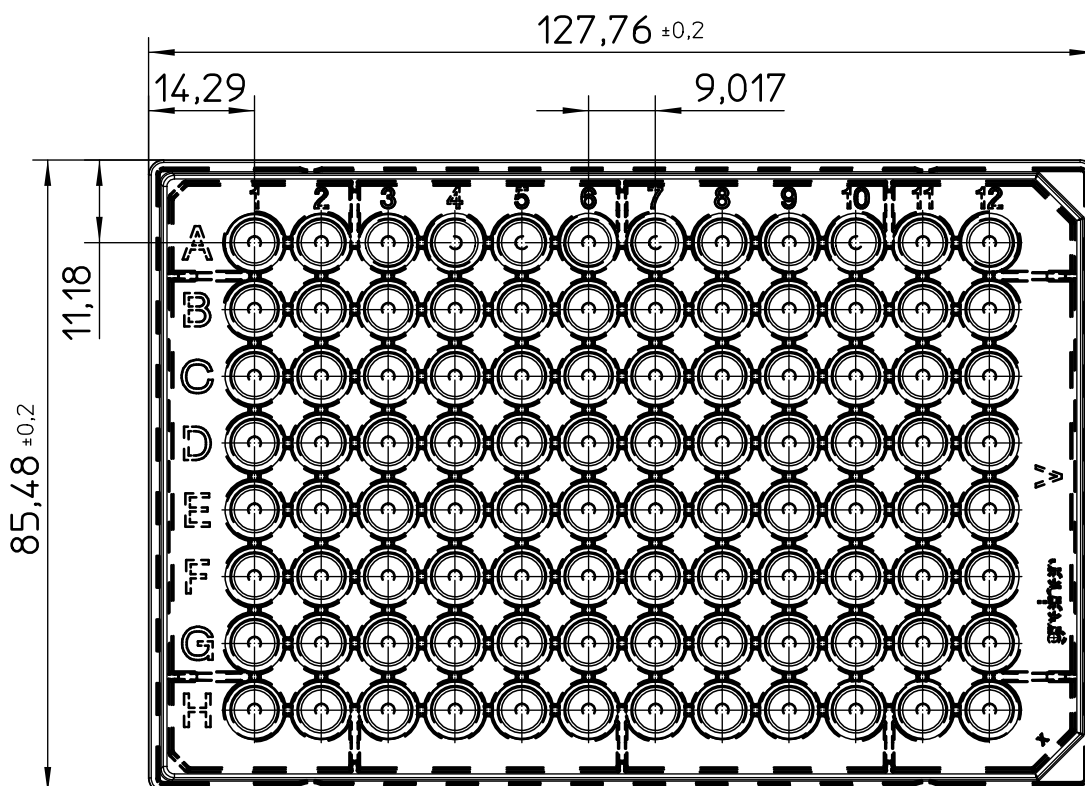
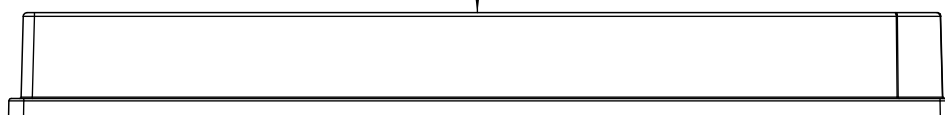

"All dimensions in mm"

Customer drawing subject to change without notice!

Uncontrolled Copy

Prior Issue	Drawn	Approved	Released	CONFIDENTIAL: Information contained in this document or drawing is confidential and proprietary to Greiner Bio-One GmbH. This document may not be reproduced for any reason without written permission from Greiner Bio-One GmbH. All rights of design, invention, and copyright are reserved.
Revision 1	Date 2015/03/16	Date 2017/02/23	Date 2017/02/23	
Date 2015/03/16	Name schwarzej	Name schwarzej	Name sonntag	

Valid for Item-No.: 651101, 651160, 651161, 651180

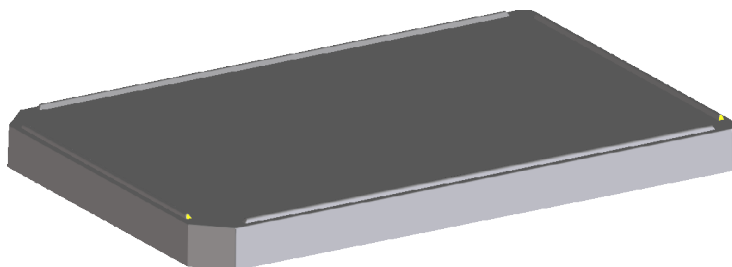

Curvature  $+0,3$   
 $-0,3$

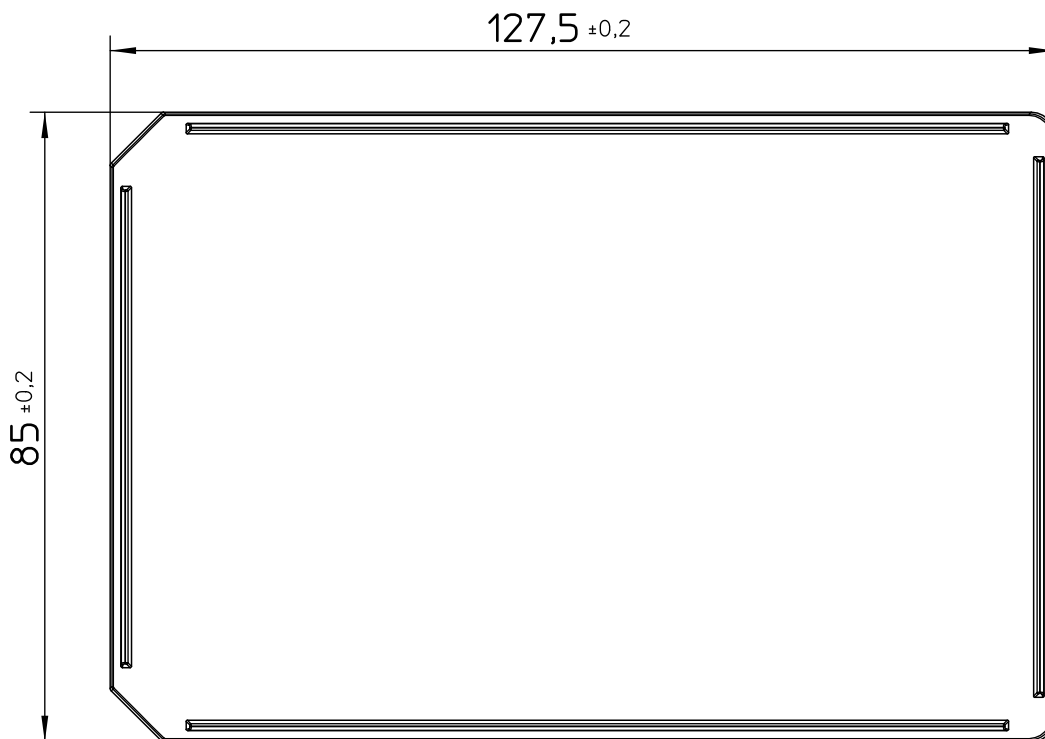
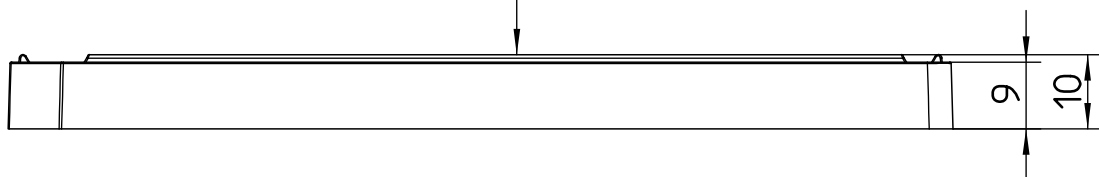

Only Part.-No. 651180 with lid

"All dimensions in mm"

Customer drawing subject to change without notice!

Uncontrolled Copy

Prior Issue	Drawn	Approved	Released	CONFIDENTIAL: Information contained in this document or drawing is confidential and proprietary to Greiner Bio-One GmbH. This document may not be reproduced for any reason without written permission from Greiner Bio-One GmbH. All rights of design, invention, and copyright are reserved.
Revision 1	Date 2015/03/16	Date 2017/02/23	Date 2017/02/23	
Date 2015/03/16	Name schwarzej	Name schwarzej	Name sonntag	

PDS No. 6511xx	<b>PRODUCT DATA SHEET</b>				Page 1 of 1
Revision 07	96 Well Microplate, PS, V-Bottom				 <b>greiner bio-one</b>
	Greiner Item-No. 6511xx				
Valid for Item-No.:	<b>651101</b>	<b>651160</b> (sterile)	<b>651161</b> (sterile)	<b>651180</b> (sterile)	

1.	Description / Specification	
1.1	Description	PS Plate, 96 well, clear, solid V-bottom, alphanumeric well coding 651101: standard 651160: physical surface treatment, sterile 651161: standard, sterile 651180: physical surface treatment, with standard lid, sterile
1.2	Dimensions	See customer drawing
1.3	Volume per well	Total volume: 234 µl (mathematically calculated) Working volume: 40 - 200 µl 651160, -180: growth area: 0,28 cm <sup>2</sup>
1.4	Material / Resin	Plate: PS (Polystyrene), free of heavy metal Lid: PS (Polystyrene), free of heavy metal
1.5	Colour	Plate: clear Lid: clear
1.6	Sterilization	651101: No 651160, -161, -180: SAL 10 <sup>-3</sup>
1.7	Quality Control	- Raw Material-Control: physical testing - Product-Control: testing of attributive and variable characteristics in accordance with the valid specification
1.8	Other Information	For single use only

2.	Features	
2.1	Basic features	All Item-No.: free of detectable DNase/RNase, human DNA and pyrogens. 651160, -180: contents non-cytotoxic
2.2	Temperature range	-20°C to +60°C
2.3	Autoclavability	No
2.4	Centrifugation, max. RCF	4800 x g: swinging-bucket rotor
2.5	Chemical Resistance	See homepage: <a href="https://www.gbo.com/en_INT/know-how-services/download-center.html">https://www.gbo.com/en_INT/know-how-services/download-center.html</a>
2.6	Shelf life	651101: N/A 651161: 5 years after month of production 651160, -180: 4 years after month of production
2.7	Other Information	-

3.	Packaging	651101	651160, -180	651161
3.1	Pieces / Bag	10	1	2
3.2	Pieces / Box	100	100	100
3.3	Lot-No.	E YY MM XXX (manufacturing facility, year, month, consecutive SAP-No.)		
3.4	Other Information	Certificate of Quality		

4.	Other Information
	-

Data Sheet subject to change without notice!

Prior Issue	Drawn	Approved	Released	<b>CONFIDENTIAL:</b> Information contained in this document or drawing is confidential and proprietary to Greiner Bio-One GmbH. This document may not be reproduced for any reason without written permission from Greiner Bio-One GmbH. All rights of design, invention, and copyright are reserved.
Revision 06	Date 19 October 2016	Date 20 October 2016	Date 20 October 2016	
Date 27.11.2014	Name S. Kaelberer	Name Dr. R. Heller	Name Dr. A. Ganser	

**DISCLAIMER:** The description of a certain product can only be considered as a guidance, because its performance ultimately depends on what the product is used for. Very often performance studies are indispensable.