

Operation Manual (EN)  
Translation of the original operation manual

## Laboratory vacuum system LVS

Types:

- ▶ LVS 105 T – 10 ef<sup>+</sup>



Manufacturer  
Gardner Denver Thomas GmbH  
Am Vogelherd 20  
98693 Ilmenau  
Germany

Tel.: +49 3677 604 0  
Fax: +49 3677 604 131  
E-mail: [welch.emea@gardnerdenver.com](mailto:welch.emea@gardnerdenver.com)  
Web: [www.gardnerdenver.com/de-de/welch](http://www.gardnerdenver.com/de-de/welch)

#### Imprint

© 2020

Reprint or duplication, also in excerpt,  
are not permitted without written ap-  
proval from Gardner Denver Thomas  
GmbH.

All rights under the copyright laws are  
expressly reserved by Gardner Den-  
ver Thomas GmbH.

We reserve the right to make changes  
and amendments.

**Contents**

<b>1</b>	<b>Important Information .....</b>	<b>6</b>
1.1	Note for the user/personnel .....	6
1.2	Depiction of warning notices and information .....	7
1.3	Explanations of safety symbols.....	7
1.4	Legend for the abbreviations .....	8
<b>2</b>	<b>Safety.....</b>	<b>10</b>
2.1	General .....	10
2.1.1	Proper use.....	10
2.1.2	Improper use.....	10
2.1.3	Foreseeable misuse.....	11
2.2	Target groups.....	11
2.2.1	Personnel qualification.....	11
2.2.2	Overview of the responsibilities .....	11
2.3	Protective measures .....	12
2.4	Special hazards .....	12
2.4.1	Hazardous materials in general .....	13
2.4.2	Explosive gases .....	14
2.4.3	Electricity.....	14
2.4.4	Mechanics .....	14
2.4.5	Vacuum .....	15
2.5	Device-specific hazards .....	15
2.5.1	Reliable operation .....	15
2.5.2	Temperatures.....	15
2.5.3	Operating fluid.....	16
2.5.4	Vacuum controller – system functions .....	16
2.5.5	Network safety .....	17
<b>3</b>	<b>Technical data.....</b>	<b>18</b>
3.1	Dimensions .....	18
3.2	Characteristic values.....	19
3.3	Supply and control connections .....	20
3.4	Application connections .....	20
3.5	Parts in contact with internal gas .....	21
<b>4</b>	<b>Description.....</b>	<b>22</b>
4.1	Field of application .....	22
4.2	Function .....	22
4.3	Set-up.....	22
4.3.1	Front of the device .....	22
4.3.2	Back of the device.....	23
4.4	Connection diagram, rotary evaporator .....	24
4.5	Attachments .....	25
4.6	Operating elements and navigation of the vacuum controller .....	26

# Contents

4.6.1	Operating elements and display .....	26
4.6.2	Navigation .....	28
4.7	Interfaces .....	28
4.8	Accessories (options) .....	29
<b>5</b>	<b>Set-up and connection .....</b>	<b>30</b>
5.1	Unpacking .....	30
5.2	Set-up .....	30
5.3	Connection .....	30
5.4	Electrical connection .....	31
5.5	Storage .....	31
<b>6</b>	<b>Operation .....</b>	<b>32</b>
6.1	Bringing into service .....	32
6.2	Operating modes and system settings .....	32
6.2.1	Operating mode 1 Manual .....	32
6.2.2	Operating mode 2 Automatic .....	33
6.2.3	Operating mode 3 Program .....	34
6.2.4	Operating mode 4 Multi-pump .....	35
6.2.5	Operating mode 5 Self-cleaning .....	36
6.2.6	System settings .....	37
6.3	Configuring the vacuum control .....	41
6.3.1	Access control .....	41
6.3.2	Log files .....	41
6.3.3	Reset to factory settings .....	42
6.4	"PC-Control 601" PC software (Option) .....	42
6.4.1	Installation .....	42
6.4.2	Connection settings .....	43
6.4.3	Main screen .....	44
6.4.4	File .....	45
6.4.5	Log files .....	46
6.4.6	Settings .....	48
6.4.7	Calibrate .....	49
6.4.8	Firmware update .....	50
6.5	Solvents table .....	51
<b>7</b>	<b>Elimination of operating faults .....</b>	<b>52</b>
<b>8</b>	<b>Maintenance .....</b>	<b>54</b>
8.1	Service and inspection .....	54
8.2	Repairs by the operator .....	55
8.2.1	Opening the device .....	55
8.2.2	Replacing the components in the pump unit .....	56
8.2.3	Installing the pump unit .....	58
8.2.4	Closing the device .....	59
8.3	Repairs by the manufacturer .....	59
8.4	Damage report .....	59

8.5	Disposal .....	59
<b>9</b>	<b>Spare parts overview.....</b>	<b>60</b>
9.1	Diaphragm pump service set .....	60
9.2	Ordering and service contact.....	60
<b>10</b>	<b>Appendix .....</b>	<b>61</b>
10.1	EU declaration of conformity.....	61
10.2	Notes.....	62

## 1 Important Information

	<b>ATTENTION</b>
	<ul style="list-style-type: none"><li>▶ Read operation manual carefully before use.</li><li>▶ Keep operation manual for later reference.</li></ul>

### 1.1 Note for the user/personnel

#### Safety

- The user/personnel must have read and understood the operation manual completely before starting work.
- The operation manual must always be kept in the place it will be used and be available to the user/personnel.
- The product may not be transferred without the operation manual.
- Safe operation can only be guaranteed with proper and correct use of the product. The safety instructions must be heeded!

#### General

- Vacuum apparatus/vacuum system generally refers a combination of components for vacuum applications, such as rotary evaporator with a vacuum control device and vacuum pump.
- The operator is responsible for the proper use of vacuum apparatuses/vacuum systems.

#### About this device



- For here on in, the laboratory vacuum system (LVS for short) will be referred to as "device".
- "Device" describes the entire system consisting of the integrated vacuum pump, vacuum controller, attachments and various other parts.
- In general, the pneumatic input (the connection to the application) is referred to as the "intake side" and the output (the connection to the exhaust) is called the "pressure side".
- The integrated "VCpro" vacuum controller is a system for controlling the vacuum system and will be referred to as the "vacuum controller" below.
  - **VCpro 601:** Vacuum pressure control via an electromagnetic vacuum control valve
  - **VCpro 602:** Vacuum pressure control via a speed-controlled vacuum pump

## 1.2 Depiction of warning notices and information

The warning notices are depicted as follows:

Additional symbols	 <b>DEGREE OF RISK</b>
	<ul style="list-style-type: none"> <li>▶ Warning about possible hazards.</li> <li>▶ Consequences if warning is not heeded.</li> <li>▶ Heed note to prevent!</li> </ul>







Degree of risk

 <b>DANGER</b>	▶ Indicates a threatening risk that results in dangerous injuries or death.
 <b>WARNING</b>	▶ Indicates a possibly hazardous situation which, if not avoided, can result in serious injuries or life-threatening consequences.
 <b>CAUTION</b>	▶ Indicates a possibly hazardous situation. If not avoided, this can result in light injury.









Depiction of information

Additional symbol	<b>SIGNAL WORD</b>
	▶ Important information for the user/operator.

## 1.3 Explanations of safety symbols

Symbol	Explanation
	▶ General warning symbol
	▶ High voltage warning
	▶ Explosive materials warning
	▶ Hot surface warning
	▶ Poisonous substances warning
	▶ Warning against low temperatures

# Important Information

Symbol	Explanation
	▶ <b>General prohibition</b>
	▶ <b>General mandatory sign</b>
	▶ <b>Disconnect from power</b>
	▶ <b>Protective clothing – gloves</b>
	▶ <b>Protective clothing – goggles</b>
	▶ <b>Heed operating instructions</b>
	▶ <b>Components endangered by electrostatic discharge (ESD)</b>
	▶ <b>General information</b>

## 1.4 Legend for the abbreviations

Abbreviation	Designation or meaning	Explanation
<b>A</b>	Ampere - current strength	Electrical unit
<b>abs</b>	absolute	Value specification
<b>AC</b>	Alternating current	Electrical unit
<b>ATM</b>	Atmosphere	Pressure specification
<b>DC</b>	Direct current	Electrical unit
<b>DN</b>	Nominal diameter – inner diameter (French: diamètre nominal)	Dimension specification
<b>EPDM</b>	Ethylene propylene diene rubber	Material
<b>EX</b>	Exhaust	Connection designation
<b>FFKM</b>	Perfluorinated rubber	Material
<b>FKM</b>	Fluorinated rubber	Material
<b>FS</b>	Full scale	Scale end value
<b>FSS</b>	Level sensor (German: Füllstandssensor)	Component
<b>hh:mm:ss</b>	hour / minute / second	Time specification
<b>hPa</b>	Hektopascal (1 hPa = 1 mbar = 0.75 Torr)	Pressure unit



Abbreviation	Designation or meaning	Explanation
<b>Hz</b>	Hertz - frequency	Electrical unit
<b>IN</b>	Intake	Connection designation
<b>LVS</b>	Labor-vacuum-system	Device model
<b>max.</b>	Maximum	Value specification
<b>mbar</b>	Millibar (1 mbar = 1 hPa = 0.75 Torr)	Pressure unit
<b>min.</b>	Minimum	Value specification
<b>mm</b>	Millimeter	Dimension specification
<b>MPC</b>	Diaphragm pump, chemically resistant (German: Membran Pumpe)	Device model
<b>pneum.</b>	pneumatic	Connection designation
<b>PP</b>	Polypropylene	Material
<b>PTFE</b>	Polytetrafluorethylene	Material
<b>PVDF</b>	Polyvinylidene fluoride	Material
<b>r.F.</b>	Relative humidity in % (German: relative Feuchte)	Environmental condition
<b>Torr</b>	Torr (1 Torr = 1.33 mbar = 1.33 hPa)	Pressure unit
<b>V</b>	Volt - voltage	Electrical unit
<b>VCpro 601</b>	Vacuum controller - vacuum control valve	Device variant
<b>VCpro 602</b>	Vacuum controller - motor speed control	Device variant
<b>W</b>	Watt – power	Electrical unit
<b>WV</b>	Water valve	Component

## 2 Safety

### 2.1 General

- Anyone who plans to use the device must have read and understood the following safety and warning notices.
- Activities may only be performed by trained personnel who are familiar with the special hazards and heed them and who have understood how the device functions and the operation manual.
- The device may only be used if it is in technically perfect condition.

#### 2.1.1 Proper use

The device is intended for indoor use. The environment must be non-explosive. Operation of the device is only permissible under the conditions named

- in section 3 Technical data,
- on the type plate,
- and in the technical specification for the order in question.

**Furthermore, proper use includes:**

- Heeding the operation manual
  - Heeding the warning/safety measures in this operation manual and of the connected devices
  - Adherence to the operation manuals for connected vacuum pumps and vacuum control devices from Gardner Denver Thomas GmbH
  - Use of approved spare parts and accessories from Gardner Denver Thomas GmbH
- ▶ **Any other use will be regarded as improper!**

#### 2.1.2 Improper use

	<b>! CAUTION</b>
	<p>▶ <b>With proper use, personal injury or property damage can occur.</b></p> <p>▶ <b>The operator must ensure proper operation!</b></p>

**The following is regarded as improper use:**

- Use that does not correspond to the proper use
- Use outside of the specifications of the technical data, the type plate or the conditions named in the delivery contract
- Operation in less-than-perfect technical condition
- Operation with missing or defective protective equipment
- Operation outdoors

	<b>ATTENTION</b>
	<p>▶ <b>Uses that are improper must be prevented by the operator or measures must be taken that ensure proper operation!</b></p>

## 2.1.3 Foreseeable misuse

	<b>ATTENTION</b>
	▶ <b>Misuse is generally FORBIDDEN. It also counts as improper!</b>

Regarded as foreseeable misuse are the following:

- Operation in explosive environments (see section 2.4.2 *Explosive gases*)
- Conveying of critical media (outside of the specifications in section 6.5 Solvents table)
- Manipulation of the software and hardware, such as impermissible attachments and modifications
- Leaving critical applications unsupervised
- Operation of the device with tools or other impermissible objects

## 2.2 Target groups

	<b>ATTENTION</b>
	▶ <b>There can be misuse due to use by untrained personnel.</b> ▶ <b>The operator must ensure that the personnel is trained properly and all necessary safety measures are adhered to!</b>

### 2.2.1 Personnel qualification

Target group	Area of activity
<b>User</b>	Laboratory personnel, e.g. chemists
<b>Specialized personnel</b>	Person with professional qualifications, e.g. mechanic, electrician, laboratory director, etc.
<b>Manufacturer</b>	Service and maintenance/repair may only be performed by the manufacturer or authorized service providers

### 2.2.2 Overview of the responsibilities

Activity	User	Specialized personnel	Manufacturer
Setup/connection	x	x	x
Bringing into service	x	x	x
Network integration		x	x
Operation	x	x	x
System settings	(1)	x	x
Sensor calibration	x	x	x
Factory settings	(1)	x	x
Troubleshooting	x	x	x
Firmware update	x	x	x
Analysis of operating fault	x	x	x
Elimination of operating fault	(2)	x	x
Maintenance/inspection, external	x	x	x
Maintenance/inspection, internal	(2)	x	x

Activity	User	Specialized personnel	Manufacturer
Self-cleaning	x	x	
Repairs by operator	(2)	x	
Damage report	x	x	
Decontamination			(3)
Disposal		x	x

(1) Access can be blocked by the user (see section 6.3.1 Access control).



(2) Performed by specially trained users

(3) Performed by qualified and authorized service providers only

## 2.3 Protective measures

All protective measures must be the highest priority in order to protect the life and health of personnel. In case of potential safety hazards, these must be assessed and measures taken to avoid hazards. Uses that endanger health and life are not permitted.

Applicable operating instructions from the operator and the national regulations for accident prevention, safety and occupational safety must be heeded.



 	<b>PROTECTIVE CLOTHING</b>
	<ul style="list-style-type: none"> <li>▶ For applications that require protective clothing, this clothing must be worn for personal safety.</li> <li>▶ The operator must specify the type and manner of protective clothing!</li> </ul>

## 2.4 Special hazards

	<b>EMERGENCY OFF</b>
	<ul style="list-style-type: none"> <li>▶ In dangerous situations, de-energize the device by pressing the power switch or disconnecting the power plug.</li> </ul>

	<b>DE-ENERGIZED STATE</b>
	<ul style="list-style-type: none"> <li>▶ When the device is de-energized, all valves are closed and the motor stops.</li> </ul>

## 2.4.1 Hazardous materials in general

	 <b>WARNING</b>
	<ul style="list-style-type: none"> <li>▶ Hazardous materials in the medium to be conveyed can cause personal injuries and property damage.</li> <li>▶ Heed the warning and safety instructions for handling hazardous materials!</li> </ul>

	<b>HAZARDOUS MATERIALS</b>
	<ul style="list-style-type: none"> <li>▶ For applications with materials with H and P classes, measures must be taken to protect the health of people and the environment.</li> <li>▶ The operator must – taking into account the applicable regulations – assess the possible hazards in order to prevent personal injuries and damage to the environment and property. The operator bears responsibility for this!</li> </ul>

**For applications with hazardous materials, the following must be heeded:**

- Adhere to the requirements of the manufacturer's safety data sheets for hazardous materials.
- Prevent the escape of poisonous and environmentally-damaging substances from the apparatus.
- To protect the environment and the apparatus, use a separator (e.g. condenser).
- Check the strength and leak tightness of the connecting lines.
- Check the proper installation of the sensor in the vacuum apparatus.

	<b>MATERIAL RESISTANCE</b>
	<ul style="list-style-type: none"> <li>▶ In case of applications with aggressive media, the resistance of device parts that come into contact with the media must be evaluated by the user (see section 3.5 <i>Parts in contact with internal gas</i>).</li> </ul>

	<b>SERVICE / REPAIR</b>
	<ul style="list-style-type: none"> <li>▶ Service and repair by the manufacturer or in authorized facilities only with transfer of the completely filled-out damage report with decontamination declaration.</li> </ul>



The damage report form is available for download from our website [www.gardnerdenver.com/de-de/welch](http://www.gardnerdenver.com/de-de/welch) on the "Service" menu → „Damage reports“.

## 2.4.2 Explosive gases



The device is not suited for operation in areas subject to explosion or for conveying media that can form explosive mixtures.

The device is not certified as per ATEX Directive 2014/34/EU.

When using the device in areas subject to explosion, the system operator is obligated to adhere to the ATEX 137 Directive 1999/92/EC.

  	 <b>DANGER</b>
	<ul style="list-style-type: none"> <li>▶ <b>Caution, risk of explosion due to critical applications.</b></li> <li>▶ <b>With use of the device in an atmosphere subject to explosion or in applications where explosive mixtures can form, there is danger to life.</b></li> <li>▶ <b>The operator must ensure that the application and the area are not potentially explosive.</b></li> </ul>

## 2.4.3 Electricity

  	 <b>DANGER</b>
	<ul style="list-style-type: none"> <li>▶ <b>There is danger to life when opening the device. Touching exposed electrical conductors can cause immediate death.</b></li> <li>▶ <b>Opening the device is generally forbidden; this may only be done by specialists.</b></li> <li>▶ <b>Before opening the device, disconnect the power plug!</b></li> </ul>

**Heed the following instructions:**

- Operating the device without the housing is forbidden.
- Only the manufacturer, authorized workshops or trained personnel may change the power supply, display or printed circuit board.
- If the device is defective, switch it off and disconnect the power plug.
- Only use the supplied standardized power plug.
- The power plug and cable must be in perfect condition.
- The electrical network must have protective conductors in accordance with IEC 60364-4-41. The protective conductor may not be interrupted.
- Note that the device must be regarded as a portable tool.

## 2.4.4 Mechanics



	<b>NOTE</b>
	<ul style="list-style-type: none"> <li>▶ <b>In case of improper use or manipulation of the device, there can be property damage to the connected vacuum pump or vacuum apparatus!</b></li> </ul>

Operate the device only according to this operation manual and the instructions in the operation manuals for the connected devices.

This device is not permitted to be operated with overpressure.

Solid and liquid materials in the gas being conveyed can compromise the function of the sensor and valves. Prevent the penetration of solid particles into the vacuum apparatus.

## 2.4.5 Vacuum

	 <b>WARNING</b>
	<ul style="list-style-type: none"> <li>▶ Hazard due to sudden ventilation of the vacuum apparatus.</li> <li>▶ Due to sudden ventilation, the vacuum apparatus can explode.</li> <li>▶ Prevent sudden ventilation. Check the pressure in the vacuum apparatus before you disconnect the pneumatic connections. A vacuum can also exist in the vacuum apparatus when the device is switched off.</li> </ul>

	<b>GLASS APPARATUS</b>
	<ul style="list-style-type: none"> <li>▶ Glass apparatus is especially endangered. Make sure that the glass apparatus is vacuum-proof and non-breakable.</li> </ul>

## 2.5 Device-specific hazards

### 2.5.1 Reliable operation

	<b>CONVEYING VAPORS</b>
	<ul style="list-style-type: none"> <li>▶ When conveying vapors, condensation may form inside the vacuum pump. This can (greatly) reduce the service life of the components.</li> <li>▶ The device must be at operating temperature before applications are started. This will reduce condensation formation in the vacuum pump.</li> </ul>



Do not operate the device without a separator or emission condenser. The separator can only be emptied after the vacuum system has been ventilated. The condensate must then be disposed of in accordance with legal requirements.

Note possible hazards caused by the required substances (see section 2.4.1 *Hazardous materials* in general)!

**In addition, note the following:**

- It is not permissible to use the device to convey liquid materials.
- The exhaust line must be freely and sufficiently sized.
- The exhaust line must be routed in such a way that the condensate can drain.
- Check the glass apparatuses for damage before use.

### 2.5.2 Temperatures

  	<b>MEDIA/OPERATING TEMPERATURE</b>
	<ul style="list-style-type: none"> <li>▶ The permissible media temperature must not be exceeded.</li> <li>▶ Ensure that the maximum ambient temperature is not exceeded. Sufficient ventilation around the device must be ensured.</li> <li>▶ Values for permissible operation: see section 3.2 <i>Characteristic values</i>.</li> </ul>

## 2.5.3 Operating fluid

	<b>! CAUTION</b>
	<ul style="list-style-type: none"> <li>▶ Risk of injury from contact with cold surfaces!</li> <li>▶ When using very cold coolants, surfaces such as those on the emission condenser can become dangerously low.</li> <li>▶ The operator must ensure safe operation and take measures to protect the user if necessary (see sections 2.3 <i>Protective measures</i> and 6.3.1 <i>Access control</i>).</li> </ul>

## 2.5.4 Vacuum controller – system functions

The following settings for the "control systems" must be assessed separately for particular vacuum applications (see section 6.2.6 *System settings*).

### "Allow ventilation"

- When this function is activated, the application can be manually (see section 4.6.1 *Operating elements and display*) or automatically ventilated via the pressure control.
- Through activation of the function, media, which may be harmful, can escape from the application and enter into the environment.

	<b>ATTENTION</b>
	<ul style="list-style-type: none"> <li>▶ If the function is activated, there is a possibility that the ambient air will enter into the applications. This can result in uncontrolled reactions in the application.</li> <li>▶ Note that an inert gas may need to be connected to the ventilation valve (see sections 3.4 <i>Application connections</i> and 4.3.2 <i>Back of the device</i>).</li> </ul>

### "Auto Start"

- If the "Auto Start" function is activated, the device starts automatically after a power failure or after the power switch was pressed. This can cause undesired after-effects in your application.
- An automatic start only occurs if an operating mode was started previously.
- Make sure that critical applications are not unsupervised!

	<b>! WARNING</b>
	<ul style="list-style-type: none"> <li>▶ Activating the "Auto start" parameter in the system setting can result in hazards for the user and his environment.</li> <li>▶ Check system settings with automatic start-up function and assess possible hazards for your application!</li> </ul>

Both system settings are not activated in the factory setting. Before you activate the functions, make sure that there is no hazard with your application. The operator must assess possible hazards in order to guarantee the safety of users!

Unauthorized activation of the functions can be prevented with an ADMIN password (see section 6.3.1 *Access control*).



## 2.5.5 Network safety

**NOTE**

- ▶ The vacuum controller of the device is network-capable via the LAN connection. This introduces the possibility of external access to the vacuum controller (or the device). Unauthorized access can cause manipulation of the applications.  
The operator must guarantee network security in order to prevent undesired access to the vacuum controller (or the device).

## 3 Technical data

### 3.1 Dimensions

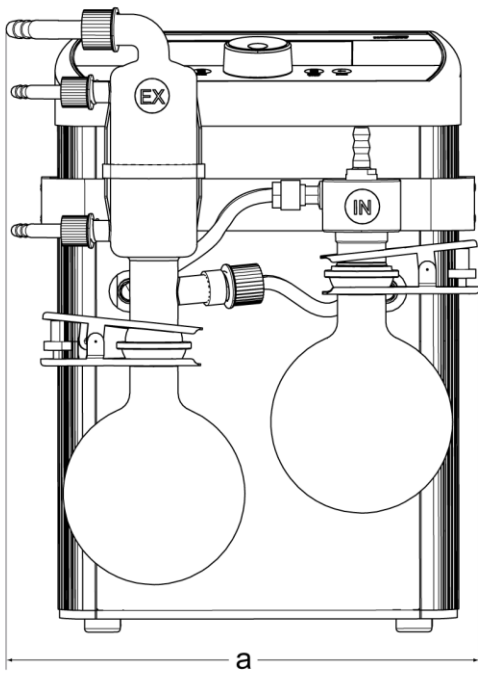

Fig. 3.1 – View of device, front

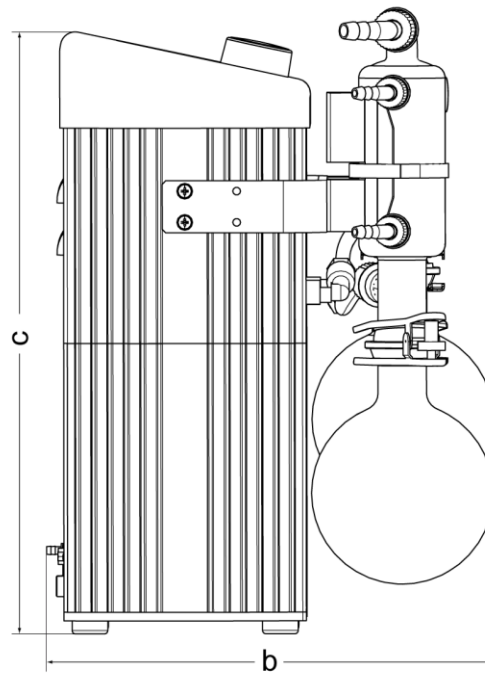

Fig. 3.2 – View of device, left

Pos.	Dimensions
a	Width: 250 mm
b	Depth: 260 mm
c	Height: 435 mm

**3.2 Characteristic values**

Parameter	Data	Unit
Designation	LVS 105 T – 10 ef +	
Item number	124184	

<b>Whole device</b>		
Pumping speed ISO 21360-1	1,1	mbar
	18	l/min
Ultimate pressure (basic pressure) ISO 21360-1	≤2	mbar
Max. input/output pressure	1	bar
Degree of protection	IP 20	-
Rated voltage	115 ... 240	V AC
Rated power	130	W
Rated frequency	50 / 60	Hz
Device fuse	T 6,3	A
Sound pressure level	≤44	dB (A)
Dimensions (W/D/H)	250 / 260 / 435	mm
Weight	9,5	kg
Operating temperature	+ 15 ... + 40	°C
Media temperature	Max. +40	°C
Storage temperature	+ 10 ... + 40	°C
Storage humidity	max. 90 %	r.F.

<b>Vacuum controller (internal)</b>		
Switching/regulation precision	± 1	digit
- Frequency inverter Voltage / resolution	0 – 10 / 8	V / bits
- Pressure sensor Voltage / resolution	5 / 12	V / bits
- Ventilation valve Voltage / power / resolution	24 / 2 / 1	V / W / bits
- Water valve Voltage / power / resolution	24 / max. 4 / 1	V / W / bits
- Level sensor Voltage / resolution	24 / 1	V / bits

## Technical data

Parameter	Data	Unit
<b>Pressure sensor (internal)</b>		
Sensor type	capacitive	-
Measurement range	1 - 1100	mbar
Precision in total linearity, hysteresis and reproducibility	< ± 0.3 % FS	-

### 3.3 Supply and control connections

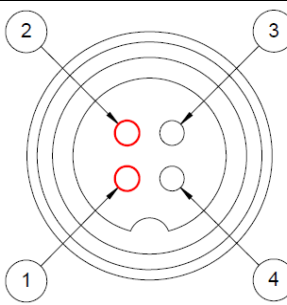
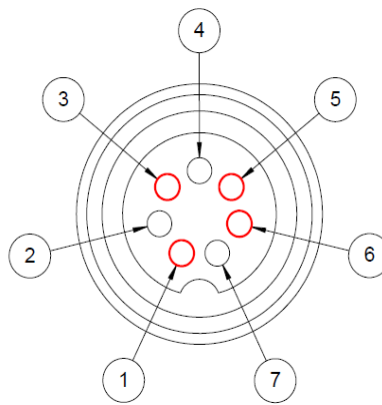
Connection type		Action	Pin assignment
IN	Power connection	IEC 60320 C14	-
IN/OUT:	Serial	RS 232, 9-pin D-Sub plug	
IN/OUT:	LAN	RJ 45, min. CAT 6	
OUT:	Water valve	Binder outlet 4-pin	 <p> <b>1</b> +24 V  <b>2</b> GND  <b>3</b> N/A  <b>4</b> n/A         </p>
OUT:	Level sensor (German: Füllstandsensoren)	Binder outlet 7-pin	 <p> <b>1</b> Signal sensor  <b>2</b> N/A  <b>3</b> GND (L-)  <b>4</b> N/A  <b>5</b> +24 V (L+)  <b>6</b> Teach  <b>7</b> N/A         </p>

### 3.4 Application connections

Connection type		Action
pneumatic	Inert gas (ventilation valve)	Hose nozzle DN 4
pneumatic	Vacuum apparatus	Hose nozzle DN 8
pneumatic	Exhaust	Hose nozzle GL 18
Operating fluid	Coolant inlet	Hose nozzle GL 14

### 3.5 Parts in contact with internal gas

Components	Material
Vacuum pump - Connection heads - Diaphragms - Valves - Seals	- PTFE - PTFE coating on elastomer - PEEK - EPDM
Pneumatic connections - Hosing - Threaded fittings - Connection fittings - O-ring seals	- PTFE - PVDF - PP - EPDM
Ventilation valve (internal) - Housing, blind plugs - Hose shaft, inert gas - Pneum. connection	FKM - PP - Stainless steel - Silicone hose
Pressure sensor incl. seal (internal)	Aluminum oxide ceramic, EPDM
Separator/emission condenser - Hose nozzle - Connection block incl. hose nozzle	Glass (vacuum-insulated) - PFTE - PP

	<b>ATTENTION</b>
	<p>▶ <b>The user must ensure that the application is uncritical in associated with the installed materials. Heed the safety instructions (see section 2.4.1 Hazardous materials in general)!</b></p>

## 4 Description

### 4.1 Field of application

The device is designed for vacuum control in the rough vacuum range in laboratories and in industry during the conveyance of gaseous media. In particular, the device is suitable for rotary evaporators of all kinds.

### 4.2 Function

The device consists of a **vacuum controller** (measurement/control device) and an **integrated membrane vacuum pump** for vacuum processes. The control is done by inputting parameters for "setpoints" and the querying of the "actual values". This enables the control and monitoring of the vacuum processes in various operating modes:

- Vacuum pressure control for the rough vacuum range - pressure range of **1100 mbar to 2 mbar**
- Vacuum pressure generation via the speed-controlled vacuum pump
- Adjustment of the pump speed via the speed control of the vacuum pump drive
- Ventilation of the unit via the integrated **ventilation valve**, if necessary with inert gas (see section 3.4 *Application connections*)
- Protection against penetration by fluids by means of an intake separator on the suction side
- Filtering and capturing of residual gases by means of the pressure-side emission condenser

### 4.3 Set-up

The vacuum controller with the operation and display elements is located at the top of the device (see section 4.6.1 *Operating elements and display*).

#### 4.3.1 Front of the device

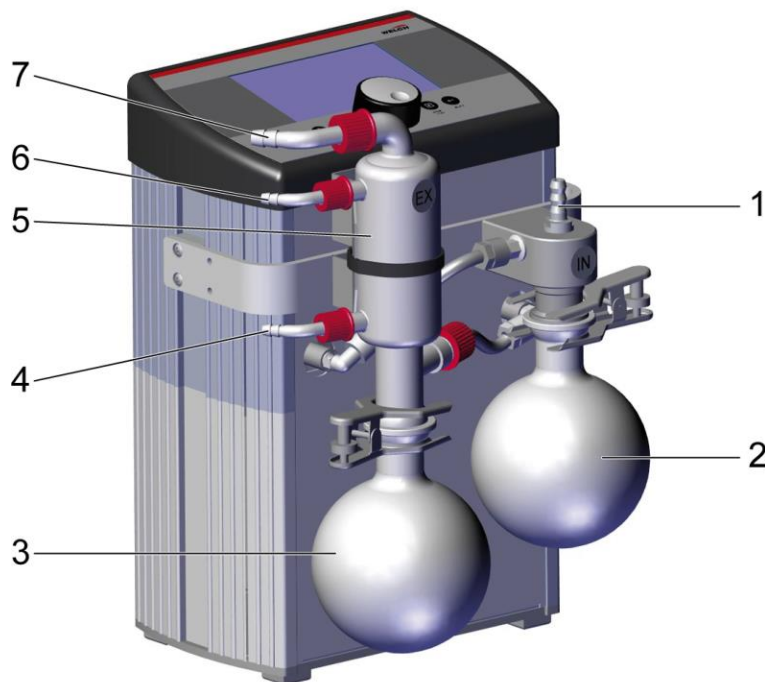

Fig. 4.1 – Front of the device: glass apparatuses and connections for the pneumatics and operating fluids

Pos.	Description
1	Pneumatic input "intake side" IN
2	Separator "intake side"
3	Separator "pressure side"
4	Coolant output
5	Emission condenser
6	Coolant input
7	Pneumatic output "pressure side" EX

### 4.3.2 Back of the device

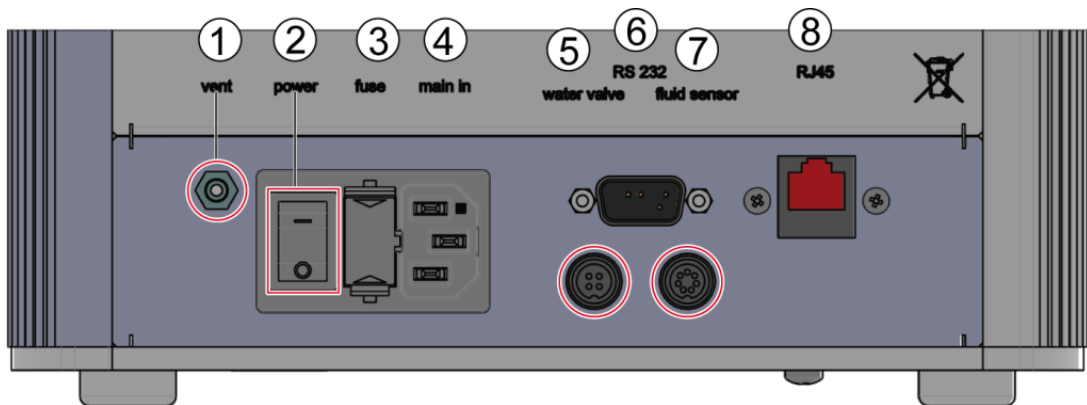

Fig. 4.2 – Back of the device: connections

Pos.	Symbol	Description
1	vent	Ventilation valve (inert gas connection)
2	power	Main power switch I/O (on/off)
3	fuse	Fuse
4	main in	Power supply connection/power cable
5	water valve	Water valve connection
6	RS 232	Serial connection (PC connection)
7	fluid sensor	Level sensor (German: Füllstandssensor)
8	RJ45	LAN connection

Detailed descriptions can be found in the following sections:

Section 3.4 *Application connections*

Section 3.3 *Supply and control connections*

Section 4.8 *Accessories (options)*

- Water valves WV
- Level sensor FSS

## 4.4 Connection diagram, rotary evaporator

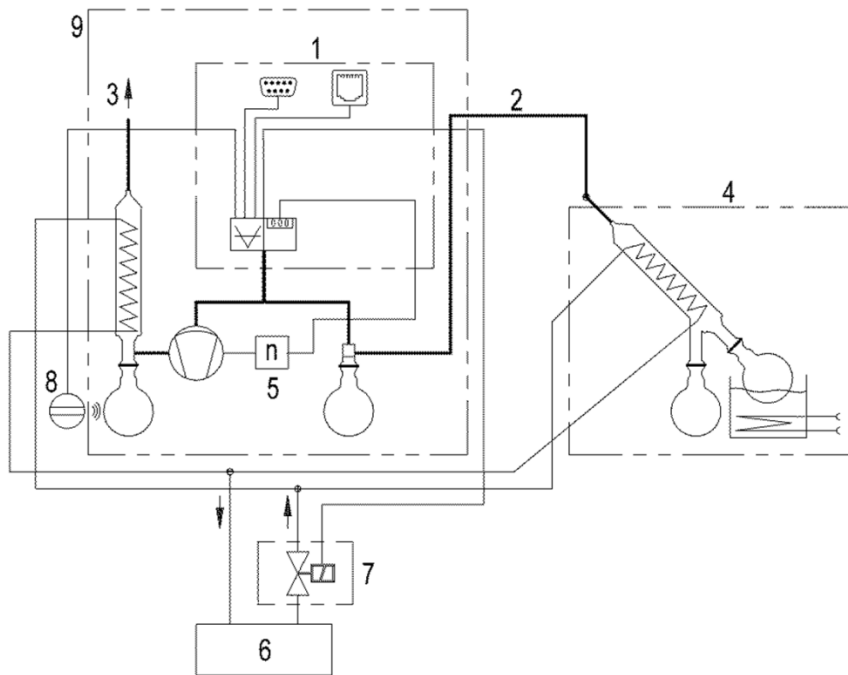

Fig. 4.3 – Connection diagram of rotary evaporator

Pos.	Description
1	Vacuum controller with communication interfaces
2	Intake line <sup>1)</sup>
3	Exhaust
4	Rotary evaporator <sup>1)</sup>
5	Speed-controlled vacuum pump
6	Coolant system, pressureless return <sup>1)</sup>
7	Water valve WV <sup>1) 2)</sup>
8	Level sensor FFS <sup>1) 2)</sup>
9	Scope of delivery of device

<sup>1)</sup> Not included in scope of delivery

<sup>2)</sup> See section 4.8 Accessories (options)



## 4.5 Attachments

### Glass apparatuses - separator

	<b>SEPARATOR</b>
	<ul style="list-style-type: none"> <li>▶ The fill level of the separator must be monitored.</li> <li>▶ The separator must be emptied at regular intervals (see section 2.5.1 <i>Reliable operation</i>).</li> </ul>

### Intake separator

The intake separator protects the diaphragm pump. Condensate and liquid media are captured in the collector.

	<b>SEPARATOR</b>
	<ul style="list-style-type: none"> <li>▶ The separator must always be used to ensure safe operation.</li> </ul>

### Emission condenser

The emission condenser is used to filter and capture residual vapors in the conveyed media.

	<b>ATTENTION</b>
	<ul style="list-style-type: none"> <li>▶ When connecting different vacuum application to the device, the captured media can mix safely. The media mixtures must not endanger persons, the environment and/or devices.</li> <li>▶ A safety valve is located at the gas inlet. Check the valve seals at regular intervals and replace them as necessary.</li> <li>▶ The exhaust connection must not have more than atmospheric pressure.</li> <li>▶ Condensate in the pneumatic connections must always be able to drain into the separators.</li> </ul>

# Description











## 4.6 Operating elements and navigation of the vacuum controller

### 4.6.1 Operating elements and display



Fig. 4.4 – View of display and control panel

Pos.	Symbol	Designation / function	Explanation
<b>1</b>	<b>Toolbar</b>		
		Vacuum control valve	Lights up when the valve is open. <b>NOTE</b> Only in device variant VCpro 601.
		Ventilation valve	Lights up when the valve is open.
		Motor	The relative motor speed is displayed in percent on the motor symbol. <b>NOTE</b> Only in device variant VCpro 602.
		Cooling water valve	Lights up when the valve is open.
		Fluid catchpot	Lights up when the level sensor (optional) is triggered.
		Serial interface	Lights up when the device is connected to the PC software via the RS 232 serial interface.
		LAN interface	Lights up when the device is connected to the PC software via the LAN interface.
		Warning	When maintenance is due
<b>2</b>	<b>Display - display field</b>		
	<b>▼ 0</b>	Pressure – setpoint	Depiction in real time (top left)
	<b>44.0</b>	Pressure – actual value	Depiction in real time (central)
	<b>≤ / ≥</b>	Less than-equal to Greater than-equal to	Actual value is outside of the range depicted (bottom left)
	<b>00:00</b>	Time	hh:mm (top middle)

Pos.	Symbol	Designation / function	Explanation
<b>3</b>	<b>Navigation bar</b>		
		Manual	See Chapter 6.2 <i>Operating modes and system settings</i>
		Automatic	
		Program	
		Multi-pump	
		Self-cleaning	
		System settings	
<b>4</b>	<b>Button bar</b>		
		<b>VENT</b>	<p>Ventilation of the application:</p> <ul style="list-style-type: none"> <li>➤ Switches on the ventilation valve</li> <li>➤ The ventilation valve stays open for as long as the button is pressed</li> <li>➤ Ventilation is possible in the activated and inactive operating mode.</li> </ul> <p><b>NOTE</b> See section 2.5.4 <i>Vacuum controller – system functions!</i></p>
		<b>PMIN</b>	<p><i>Primary function:</i> Maximum pressure reduction with max. motor speed (100%).</p> <p><i>Secondary function:</i> Pressure input: table with solvents appears on the screen.</p> <p><b>NOTE</b> See Chapter 6.5 <i>Solvents table</i></p>
		<b>START / STOP</b>	Start and stop the active operating mode selected.
		<b>BACK</b>	<p><i>Primary function:</i> Input: back Navigation: one level up</p> <p><i>Secondary function:</i> Change between numeric and graphic display in active operating mode.</p>
<b>5</b>	<b>Rotary encoder</b>		
		<b>Turn</b>	<p><i>Primary function:</i></p> <ul style="list-style-type: none"> <li>➤ Selection of operating mode</li> <li>➤ Selection of line/column in the parameter table</li> </ul> <p><i>Secondary function:</i></p> <ul style="list-style-type: none"> <li>➤ Adjust parameter value</li> <li>➤ Change pressure setpoint in active operating mode manual</li> </ul>

## Description

Pos.	Symbol	Designation / function	Explanation
		Push	<i>Primary function:</i> <ul style="list-style-type: none"> <li>➤ Activate selected operating mode</li> <li>➤ Selection of parameter value</li> </ul>
			<i>Secondary function:</i> <ul style="list-style-type: none"> <li>➤ Confirmation of set parameter value</li> <li>➤ Confirmation &lt;OK&gt; dialog field</li> <li>➤ Change pressure setpoint in active operating mode manual</li> </ul>

### 4.6.2 Navigation

The user interface for the vacuum controller features three levels:

Level	Description
A	Start window
B	Parameter for the operating mode/system settings
C	Active operating mode

In the start window (level A), the operating mode or system setting is selected by turning the rotary encoder.

- The parameter table of the operating mode or the system setting (level B) is opened by pressing the rotary encoder. To adjust the parameters, see section 6.2 *Operating modes and system settings*.
- Use the **START / STOP** button to change to the active operating mode (level C). If an operating mode is selected on the start window (level A) and the **START / STOP** button is pressed, then the selected operating mode is activated directly (level C).
- In active operating mode, the display can be changed between *numeric* and *graphic* display by pressing the **BACK** button. The display type can be changed at any time during operation.

## 4.7 Interfaces



The following functions are available via the interface of the device:

- Installation of the firmware on the device using the **WELCH-Control 601** PC software
- Control of the vacuum controller via the **WELCH-Control 601** PC software on interfaces **RJ45 LAN** and **RS 232**
- Measurement/control connection for optional units **water valve** and **level sensor**

<b>INFORMATION</b>	
	<ul style="list-style-type: none"> <li>▶ <b>The WELCH vacuum controller is compatible with all WELCH laboratory vacuum systems and WELCH diaphragm pump types. It is not blocked by any device-specific BUS system.</b></li> </ul>

#### 4.8 Accessories (options)

**NOTE** The optional units are controlled via the vacuum controller.

Figure	Designation	Order no.
	<p><b>Water valve WV 1</b></p> <p>Connection: 2 x G 3/4" external thread</p> <p>Cable length: 1 m</p>	<b>700300</b>
	<p><b>Water valve WV 2</b></p> <p>Connection: G 3/4" union DN 8 hose nozzle</p> <p>Cable length: 1 m</p>	<b>700300-02</b>
	<p><b>Level sensor FSS</b></p> <p>Cable length: 2 m</p>	<b>700380</b>
<p><a href="http://www.gardnerdenver.com/de-de/welch">www.gardnerdenver.com/de-de/welch</a> "Service" menu → download area</p>	<p><b>Operating software</b> <b>"PC-Control 601"</b> <b>Firmware</b></p>	-



#### INFORMATION

► The scope of delivery is determined by the delivery contract!

## 5 Set-up and connection

### 5.1 Unpacking

<b>ATTENTION</b>	
	<ul style="list-style-type: none"><li>▶ <b>The General Terms and Conditions of the manufacturer apply.</b></li><li>▶ <b>The scope of delivery is determined by the delivery contract!</b></li><li>▶ <b>Keep the packaging in case the device needs to be sent back to the manufacturer's factory or an authorized workshop for repair.</b></li></ul>

Unpack the device carefully. Check for:

- Transport damage
- Matching with the specifications of the delivery contract
- Completeness of the delivery

Inform us immediately if there are differences from the contractually agreed-upon scope of delivery or damage!

### 5.2 Set-up

<b>ATTENTION</b>	
	<ul style="list-style-type: none"><li>▶ <b>Heed the safety instructions.</b></li><li>▶ <b>When setting up the device, make sure that the distance to adjacent surfaces is at least 5 cm.</b></li><li>▶ <b>Provide for adequate ventilation.</b></li></ul>

Place the device on a flat and horizontal surface.

### 5.3 Connection

<b>ATTENTION</b>	
	<ul style="list-style-type: none"><li>▶ <b>Heed the safety instructions.</b></li><li>▶ <b>Use only pre-assembled lines from the manufacturer. This prevents incorrect connections.</b></li><li>▶ <b>Route all vacuum connecting lines with short distances and a large nominal width to prevent pumping speed losses. Avoid rigid connections.</b></li><li>▶ <b>Mount the vacuum connecting lines carefully to achieve a low leakage rate.</b></li><li>▶ <b>Check the vacuum lines and vacuum connections of the entire system for any leakage before beginning work.</b></li></ul>

#### Procedure

(See section 4.3 *Set-up*)

1. Remove the protective caps on the connectors.
2. Connect the intake connector of the device with your vacuum application via a vacuum hose DN 8.
3. Connect the cooling water line to the emission condenser.
4. Connect the cooling water outlet without pressure.
5. Connect the exhaust with the central exhaust system.

6. Connect the data connection for communication with the device (see section 3.3 *Supply and control* connections):
  - For communication with the device via LAN (RJ45), connect a connection cable with at least CAT-6.
  - For the serial connection (RS 232), a standardized cable can be used.
7. Connect the device with the power grid (see section 5.4. *Electrical connection*).
8. Check that the connections are all properly seated.



## ATTENTION

- ▶ **Switch the device off before connecting or disconnecting the communication interfaces.**

## 5.4 Electrical connection

The electrical connection is established using a standardized, insulated device connection cable as per IEC 60320-C13 (see section 3.3 *Supply and control* connections).

The power connection, power switch and device fuse are located on the back of the device (see section 4.3.2 *Back of the device*).

## 5.5 Storage

The device must be stored in a dust-free interior space. The storage conditions must be adhered to (see section 3.2 *Characteristic values*).



## ATTENTION

- ▶ **For storage, all connections must be sealed with the appropriate included protective caps.**
- ▶ **Another equivalent protective cap can also be used for storage.**

## 6 Operation

### 6.1 Bringing into service

	<b>ATTENTION</b>
▶ <b>Before starting up the device, read the safety instruction; see section 2 Safety.</b>	

1. Connect the device as specified and shown in the figures; see sections 3.3 *Supply and control connections*, 3.4 *Application connections* and 4.3 *Set-up*.
2. Switch on the device at the main power switch I/O on the back. After a brief initialization routine, during which STARTING is shown, the device is ready for operation.

### 6.2 Operating modes and system settings

#### 6.2.1 Operating mode 1 Manual

In the manual operating mode, the setpoint of the pressure is readjusted by the system.

PARAMETER	VALUE	Unit
Set Pressure	1000	mbar
Auto Stop Time	00:00:00	hh:mm:ss
Vent at Finish	Yes / No	
		

Parameter	Values from/to	Resoluti- on	Default	Unit
Set Pressure	0...1100	1	1000	mbar
Auto Stop Time	00:00:00...23:59:59	01:01:01	00:00:00	hh:mm:ss
Vent at Finish	Yes / No		No	

The pressure setpoint can be specified as a parameter or adjusted in real time while the operating mode is active using the operating elements; see section 4.6.1 *Operating elements and display*. Both the regulated pressure drop as well as the pressure increase are possible. The pressure increase requires, depending on the application, a ventilation of the system. The latter must be released in the vacuum controller's system settings (see section 6.2.6 System settings).



## 6.2.2 Operating mode 2 Automatic

In the **automatic operating mode**, a material separation of a mixture with up to four components can be performed.

PARAMETER	VALUE	Unit
Detection Gradient	0	mbar / min
$\Delta p$ Distillation Ramp	0	mbar
$\Delta t$ Distillation Ramp	00:00:00	hh:mm:ss
Number of Cycles	1	#

Parameter	Values from/to	Resolution	Default	Unit
Detection Gradient	-200...200	1	0	mbar/min
$\Delta p$ Distillation Ramp	-1000...0	1	0	mbar
$\Delta t$ Distillation Ramp	01:00:00...23:59:59	01:01:01	1:00:00	hh:mm:ss
Number of Cycles	1...4	1	1	
Vent at Finish	Yes / No		No	
Maximum RPM Speed	10...100	1	50	%

The separation of the material mixture is done by searching for the boiling point of the respective component via the detection gradient.

- If the pressure gradient changes with a sudden increase or drop when a component begins to boil, then this pressure value will be assumed as start setpoint.
- The distillation of the components is then done by running the distillation ramp.
- The user must specify the detection gradient for boiling and the distillation ramp for the component separation.

# Operation

## 6.2.3 Operating mode 3 Program

In the **program operating mode**, any pressure profile between 1100 mbar and 0 mbar can be programmed and up to 100 cycles can be run.

PARAMETER	VALUE	Unit
Adjust Pressure Table	1	Line(s)
Number of Cycles	1	#
Vent at Finish	No	

Parameter	Values from/to	Resolution	Default	Unit
Pressure Table	1...20	1	1	Line(s)
Number of Cycles	1...100	1	1	#
Vent at Finish	Yes / No		No	

A program includes a maximum of 20 setpoints. There is linear interpolation between the setpoints. The input of the setpoints  $p$  and the adjustment time  $\Delta t$  are specified in tabular form.

$\Delta t$ [hh:mm:ss]	$p$ [mbar]
00:00:00	0
10:30:00	200

Parameter	Values from/to	Resolution	Default	Unit
$\Delta t$	00:00:00...23:59:59	01:01:01	00:00:00	hh:mm:ss
$p$	1...1100	1	0	mbar

The set pressure setpoint  $p$  is reached in a defined timespan "setting time"  $\Delta t$ . In the process, depending on the previous actual value, the pressure is reduced to the setpoint, held or increased. Linear interpolation is applied between the pressure setpoints.

## Adding and deleting a line

Action	Activity
<b>Addition</b>	Select "Add new line" using the rotary encoder. A new line is added by pressing the rotary encoder.
<b>Deletion</b>	Select the line to be deleted (column $\Delta t$ or $p$ ) using the rotary encoder. Press the rotary encoder for approx. 2 s. The line is deleted.

## Graphic example for a series of pressure setpoints $p$ and the associated setting times $\Delta t$

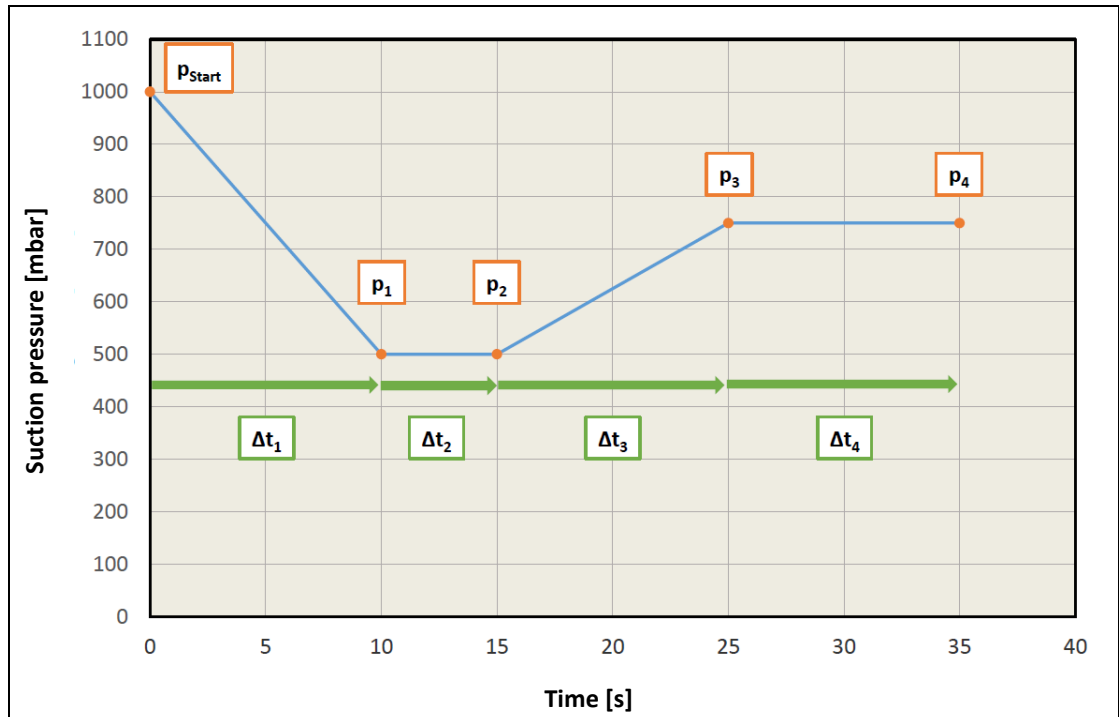

### 6.2.4 Operating mode 4 Multi-pump

**NOTE** The multi-pump operating mode cannot be used for LVS devices.

## 6.2.5 Operating mode 5 Self-cleaning

The **self-cleaning operating mode** handles the purging and drying of the pump and the pneumatic supply lines.

PARAMETER	VALUE	Unit
Cleaning Time	120	s

  

Parameter	Values from/to	Resolution	Default	Unit
Cleaning Time	1...600	1	120	s

The ventilation valve is opened and, due to the flow rate generated by the vacuum pump, the pump and the pneumatic supply lines are purged in the specified time. The integrated vacuum pump operates at the maximum rotational speed.

<b>ATTENTION</b>	
	<ul style="list-style-type: none"> <li>▶ The application is ventilated by the self-cleaning procedure.</li> <li>▶ If no other gas type is connected to the inert gas connector of the ventilation valve, cleaning is done with air.</li> </ul>

## 6.2.6 System settings

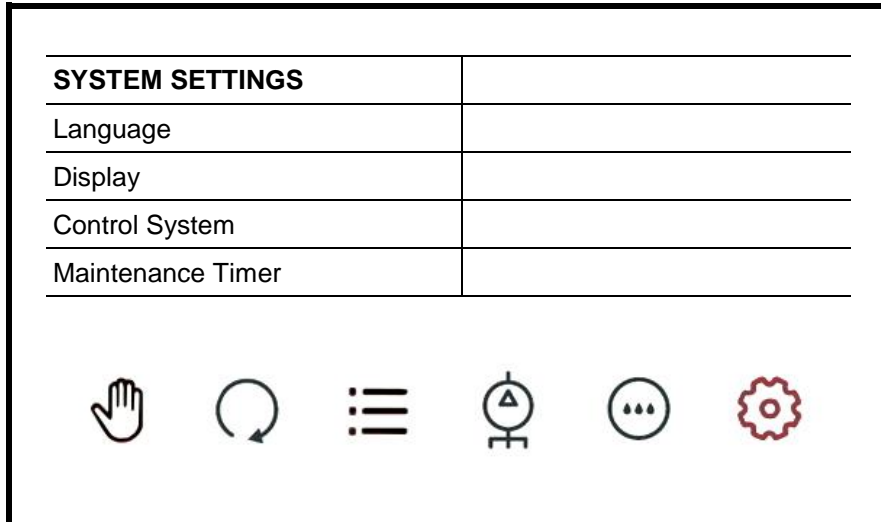

Parameter	Values from/to	Resolution	Default	Unit
<b>1 – Language</b>				
	English German French Spanish Russian Chinese		English	
<b>NOTE</b> If you have inadvertently selected the wrong language and you therefore can no longer navigate, the following process will help:				
1. Reset to factory setting (last option under system settings)				
2. Do you really want to reset? = Yes The language is reset to English.				
<b>2 – Display</b>				
<b>Brightness</b>	0...100	1	70	%
<b>Color scheme</b>	Light Dark		Light	
<b>Pressure unit</b>	mbar kPa torr Psi		mbar	
<b>Pressure scale</b>	Logarithmic Linear		Logarithmic	
<b>NOTE</b> Logarithmic and linear output of the pressure range for both numerical and graphic display.				
<b>Pressure range</b>				
Maximum pressure pMax	0...1000	1	1000	mbar
Minimum pressure pMin	0...1000	1	1	mbar
<b>NOTE</b> For a logarithmic pressure scale, pMin = 1 mbar is used automatically.				

Parameter	Values from/to	Resolution	Default	Unit
<b>Time range graph</b>	0..1200	1	60	sec
<b>NOTE</b> Defines the time range for the graphic display.				
<b>Graph display mode</b>	Static Dynamic		Static	
Static: Pressure profile is updated from left to right on the display. Dynamic: Pressure profile runs in real time from right to left via the time axis.				
<b>3 – Control system</b>				
<b>Calibration</b>				
<b>NOTE</b> Requires a calibrated sensor for the calibration! The vacuum controller uses a linear calibration of the sensor. The support points for the calibration are the atmospheric pressure and the ultimate pressure "low pressure" of the system.				
Atmospheric pressure	500...1500	1	1000	mbar
<ul style="list-style-type: none"> <li>➤ Ventilation valve open.</li> <li>➤ The pump is switched off.</li> <li>➤ The sensor is subjected directly to the ambient pressure.</li> </ul>				
Low pressure	1...200	1	1	mbar
<ul style="list-style-type: none"> <li>➤ Ventilation pressure closed.</li> <li>➤ The pump runs at a rotation of 100%.</li> <li>➤ The sensor is subjected directly to the ultimate pressure.</li> </ul>				
<b>NOTE</b> The system must be at equilibrium when the pressure is input. à The pressure value must be constant.				
<b>Hysteresis</b>	1...200	1	10	mbar
Hysteresis is a range of tolerance around the pressure setpoint.				
<b>NOTE</b> A hysteresis value that is too small can cause frequent switching of the vacuum control valve and reduce the service life of the vacuum control valves!				
<b>Auto start</b>	No / Yes		No	
In case of power failure, the last active operating mode is started again.				
<b>NOTE</b> An automatic start-up can cause undesired reactions. Heed the safety instructions (see section 2.5.4 <i>Vacuum controller – system functions</i> )!				
<b>Cooling water</b>	Always Only during operation Run-on after end: 0...60	1	Always	min
<b>Allow ventilation</b>	No / Yes		No	
<b>NOTE</b> Heed the safety instructions (see section 2.5.4 <i>Vacuum controller – system functions</i> )! Setting this option disables all other ventilation settings in the individual modes. Enabling ventilation can be protected with an ADMIN password if necessary. The devices have a connection for inert gas DN4.				

Parameter	Values from/to	Resolution	Default	Unit
<b>Set the lock timer</b>	0...60	1	0	min
<p><b>NOTE</b> The function can only be activated if a USER password is set.</p> <p>The device is locked if not being operated. The device is unlocked by entering the USER password. If the device is locked, the selected operating mode remains active.</p> <p><b>NOTE</b> The device can be deactivated in hazardous situations. Please note 2.4 Special hazards EMERGENCY OFF!</p>				
<b>4 – Maintenance timer</b>				
<b>Reset</b>	No / Yes			
<p>The maintenance timer serves to assist the user with the maintenance program of the connected pump. When pump maintenance is due, the user is informed of this when restarting the system/vacuum controller. The time monitoring can be set back to zero after maintenance is performed by the user or WELCH Service.</p>				
<b>5 – Access control</b>				
<b>Set the USER password</b>	0-9	1 1 1 1	Not set	
<b>Set the ADMIN password</b>	0-9	1 1 1 1	Not set	
<b>Passwords Reset</b>	No / Yes			
<p><b>NOTE</b> See section 6.3.1 Access control.</p>				
<b>6 – Log files</b>				
<b>Display log files</b>	No / Yes			
<b>Log frequency</b>	1...600	1	10	sec
<b>Display log files</b>				
<p><b>NOTE</b> See section 6.3.2 Log files.</p>				
<b>7 – Network</b>				
<b>DHCP</b>	Dynamic Static		Dynamic	
<b>IP address</b>				
<b>Subnet mask</b>	0.0.0.0 - 255.255.255.255	1.1.1.1	0.0.0.0	
<b>Gateway</b>				
<b>Status (info view)</b>				
<p>The vacuum controller is network-capable. Using an Ethernet connection, the vacuum controller can be connected to the LAN and controlled using PC software. Firmware updates can also be performed via LAN.</p> <p>The network status is monitored in real time and can be used by the user at any time to verify access to the local network.</p> <p><b>NOTE</b> See section 6.4 "PC-Control 601" PC software (Option).</p>				

# Operation

Parameter	Values from/to	Resolution	Default	Unit
<b>8 – Time and date</b>				
Set time	00:00:00 - 23:59:59	01:01:01		hh:mm:ss
Set date	01.01.2018 - 31.12.2099	01.01.2001		DD.MM.YYYY
Time and date are reset with factory setting.				
<b>9 – System information</b>				
Hardware version				
Software version				
Total operating time				
Maintenance Timer				
<b>NOTE</b> The maintenance timer displays the operating time since the last system reset and can be reset to zero (see section 4 – Maintenance timer).				
<b>10 – Reset to factory settings</b>				
Reset	No / Yes			
<b>NOTE</b> See section 6.3.3 Reset to factory settings.				



## 6.3 Configuring the vacuum control

### 6.3.1 Access control

The vacuum controller offers the opportunity to grant access rights using two profiles.

- **USER password:** protects the vacuum controller's operating area. The password is also required on restart or to unlock the device.
- **ADMIN password:** additionally protects the device's system settings and can also be used for unlocking.

If passwords are used on the end device, these passwords are also required for access via PC.

**NOTE** You must set the ADMIN password before you can set the USER password.

#### Set ADMIN password

1. Select the "System settings" menu option.
2. Select the "Access control" menu option.
3. Select the "Set ADMIN password" menu option.
4. Select 4 digits between 0 and 9.
5. Confirm by entering the 4 digits again.
6. Confirm your selection with "OK."

#### Set USER password

1. Select the "System settings" menu option.
2. Select the "Access control" menu option.
3. Select the "Set USER password" menu option.
4. Select 4 digits between 0 and 9.
5. Confirm by entering the 4 digits again.
6. Confirm your selection with "OK."

#### Reset passwords

1. Select the "System settings" menu option.
2. Select the "Access control" menu option.
3. Select the "Reset passwords" menu option.
4. Confirm your selection with "Yes."

### 6.3.2 Log files

#### Create log files

1. Select the "System settings" menu option.
2. Select the "Log files" menu option.
3. Select the "Create log files" menu option.
4. Confirm your selection with "Yes."

#### Log frequency

1. Select the "System settings" menu option.
2. Select the "Log files" menu option.
3. Select the "Log frequency" menu option.
4. Select a setting between 1 s and 600 s.
5. Confirm your entry.

## Display log files

1. Select the "System settings" menu option.
2. Select the "Log files" menu option.
3. Select the "Display log files" menu option.
4. Select a log file.
5. Confirm your entry.

## Delete log files

1. Select the "System settings" menu option.
2. Select the "Log files" menu option.
3. Select the "Display log files" menu option.
4. Press the rotary encoder for 2 s.
5. You will see "Do you really want to delete log files?"
6. Confirm your selection with "Yes."

### 6.3.3 Reset to factory settings

1. Select the "System settings" menu option.
2. Select the "Reset to factory settings" menu option.
3. Confirm your selection with "Yes."

**NOTE** After selecting "Yes" (with check mark), the language is set back to the factory setting (English). All values are also reset to the factory settings.

## 6.4 "PC-Control 601" PC software (Option)

The **PC-Control 601** PC software is used for the remote control of the vacuum controller of the device. In general, the PC software offers the same control options as found in the end device. In addition, the following operations are possible with the PC software:

- Firmware updates
- Transfer time and date from the PC
- Factory settings and factory calibration (not public)

### 6.4.1 Installation

**NOTE** The PC software can be downloaded as installer package. The file "setup.exe" installs the PC software and the required CVI Runtime Environment.

1. Select the "PC-Control 601" PC software. It is available as freeware from [www.gardnerdenver.com/de-de/welch](http://www.gardnerdenver.com/de-de/welch) in the "Service" menu à download area.
2. Call up the PC software with "VC601\_XXX.exe" in the installation directory.

**NOTE** XXX describes the sequential version number of the PC software.

## 6.4.2 Connection settings

The vacuum controller can be addressed via RS 232 or LAN. Using the menu bar (see section 6.4.3 *Main screen*), it is possible to establish the connection under [Communication settings].

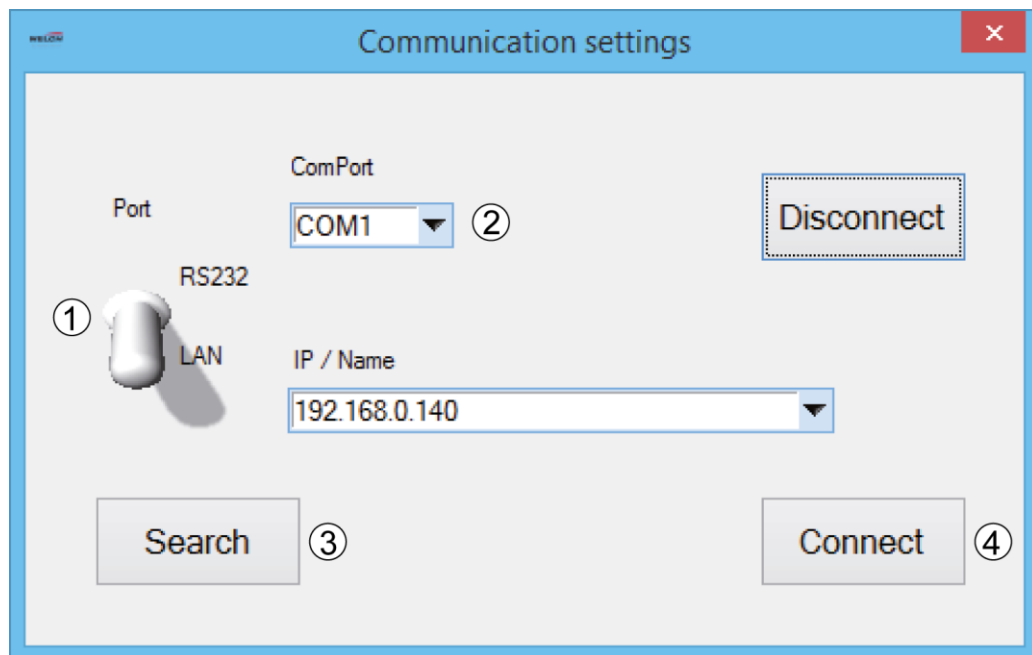

- (1) The port rocker switch can be set either to RS 232 oder LAN.
- (2) For ComPort, all ComPorts found on the PC are listed. Select the port used.
- (3) The **Search** button activates the search for the vacuum controllers in the **LAN network**, in the LAN mode:
  - The list of vacuum controllers connected to the network is updated.
  - You can select a vacuum controller unit via the **IP/Name** list.
  - The selected vacuum controller is recognized on a pre-defined UDP port via broadcast key.
- (4) The **Connect** button is used to establish the connection.

**NOTE** Only one connection is permitted per vacuum controller!

	<b>DEVICE NAME</b>
	<p>▶ The name is the 6-digit serial number of the device (see type label) and is displayed after the IP address as SNXXXXXX.</p> <div style="border: 1px solid #ccc; padding: 2px; margin-top: 5px;"> <p>IP / Name</p> <p>192.168.9.20: SN185006</p> </div>

	<b>NOTE</b>
	<p>▶ If the device is locked, either the user password or the admin password is requested in order to unlock the end device and thus to transfer the commands to the end device via the PC software.</p> <p>▶ The exception is the first press of the STOP button, which can be pressed without a password, also on the end device, for safety reasons in order to switch off the function of the end device.</p>

# Operation

## 6.4.3 Main screen

When starting the PC software and by pressing the **Measure** (A) button, you open the main screen.

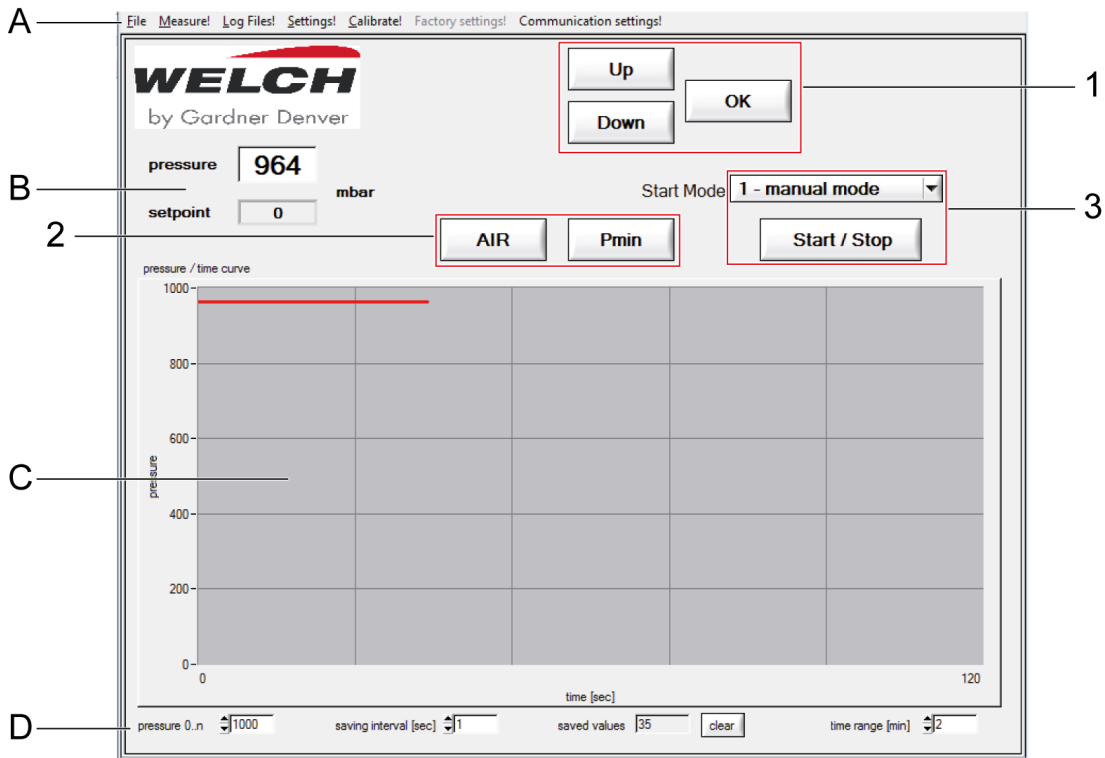

The graphic shows the pressure profile (C). Here, both the time and the pressure display area can be set using the parameter field (D). The keys correspond largely to the keys on the vacuum controller. The buttons are operated with the left mouse button.

Pos.	Element	Function
A	<Menu bar>	Selection of the function areas of the PC software
B	<Display field>	Numeric specification: <ul style="list-style-type: none"> <li>➤ Pressure actual value <b>pressure</b></li> <li>➤ Pressure setpoint <b>setpoint</b></li> </ul>
C	<Display field>	Display of pressure actual value (red line) over time for the connected device
D	<Parameter field>	Setting of the diagram axes: <ul style="list-style-type: none"> <li>➤ Pressure <b>pressure 0...n</b> (10 to 1600 mbar)</li> <li>➤ Time <b>time range [min]</b> (1...83 min)</li> </ul> and pressure data recording: <ul style="list-style-type: none"> <li>➤ Storage interval <b>saving interval [s]</b> (1 to 60•s)</li> <li>➤ Measurement points <b>saved values</b> (info display)</li> </ul>

Pos.	Element	Function
1	<OK>	Sets the current pressure as the setpoint, only possible with active operating mode
	<Down>	Decrease setpoint with active operating mode > by 1 mbar when pressed once > continuously when pressed and held
	<Up>	Increases the temporary setpoint when the operating mode is active > by 1 mbar when pressed once > continuously in 1 mbar steps when pressed and held
2	<Pmin>	Starts maximum pressure reduction
	<Air>	Opens the ventilation valve when pressed and closes it when released
3	<Start Mode>	Selection of the operating mode that should be started
	<Start / Stop>	Starts or stops the active operating mode

#### 6.4.4 File

File	
<b>Save settings</b>	Save settings of the Settings dialog in a file
<b>Load settings</b>	Load settings of the Settings dialog from a file
<b>Save memory</b>	Save the pressure data in a file
<b>Load memory</b>	Load the pressure data from a file
<b>Print curve</b>	Print the current pressure curve on the default printer
<b>Password</b>	The password protects the factory settings of the vacuum controller. WELCH service can use the password to change the controller's factory settings.
<b>Info</b>	Information about the software version
<b>Firmware update</b>	Install the selected firmware file on the end device
<b>Exit &lt;ESC&gt;</b>	Exit PC software

## 6.4.5 Log files

In the **Log Files** menu, you can display the data stored in the vacuum controller, store it on the PC and delete it.

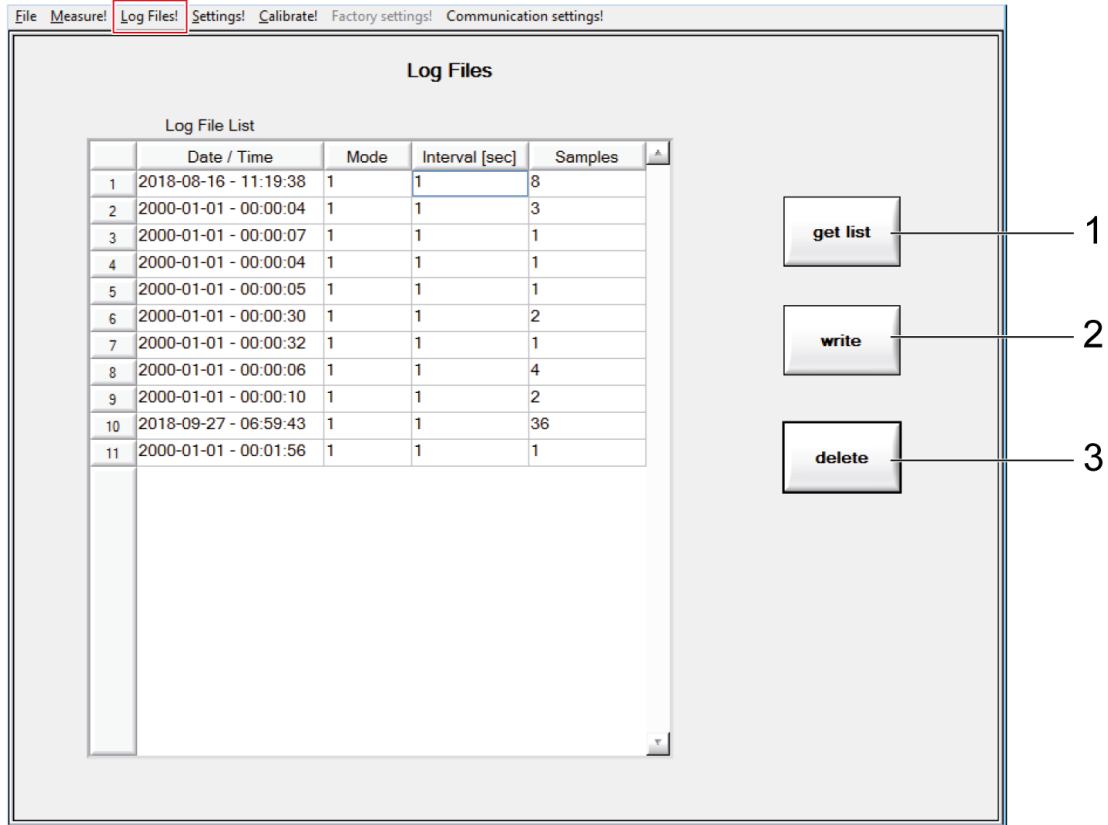

Display the log files with **get list** (1). Use **write** (2) to save log files. Use **delete** (3) to delete log files.

```

VC601 log file from 2018-11-21 - 08:35:24
Mode 1
Intervall: 1 sec
Samples: 45
Pressure [mbar] setpoint [mbar] Speed [%] IO-State
936.4 1000.0 0 0x0B
936.1 1000.0 0 0x0F
937.0 1021.0 0 0x0F
937.9 994.0 0 0x0F
937.3 941.0 0 0x0B
934.6 872.0 76 0x0B
929.2 808.0 100 0x0B
931.3 738.0 100 0x0B
930.7 0.0 100 0x0B
    
```

The ASCII file is saved in the \*.vcl format and can be opened with a text editor (as pictured above). The first three columns display the actual pressure **Pressure [mbar]**, the setpoint **Setpoint [mbar]** and the motor speed **Speed [%]**. The current state **IO-State** of the actuators and sensors is output in hexadecimal format.

The hexadecimal formulation (the last two characters of the **IO-State** output) can be transformed into a 6-digit binary sequence, see example below. The status of the actuator or sensor in question is arranged from right to left in the 6-digit binary sequence.

**Bit status: actuator / sensor**

- 1 = active / open
- 0 = inactive / closed.

The following bit assignment is used for the logging:

Binary Pos.	Actuator / sensor
1	Relay output
2	Vacuum control valve output
3	Ventilation valve output
4	Cooling water valve output
5	Adjust level sensor
6	Level sensor input

**Example:** 0X0B = 001011 → 0XHex = binary

Binary	Actuator / sensor
1	Relay output
1	Vacuum control valve output
0	Ventilation valve output
1	Cooling water valve output
0	Adjust level sensor
0	Level sensor input

Thus the vacuum control valve and the water valve are open and the ventilation valve is closed.

## 6.4.6 Settings

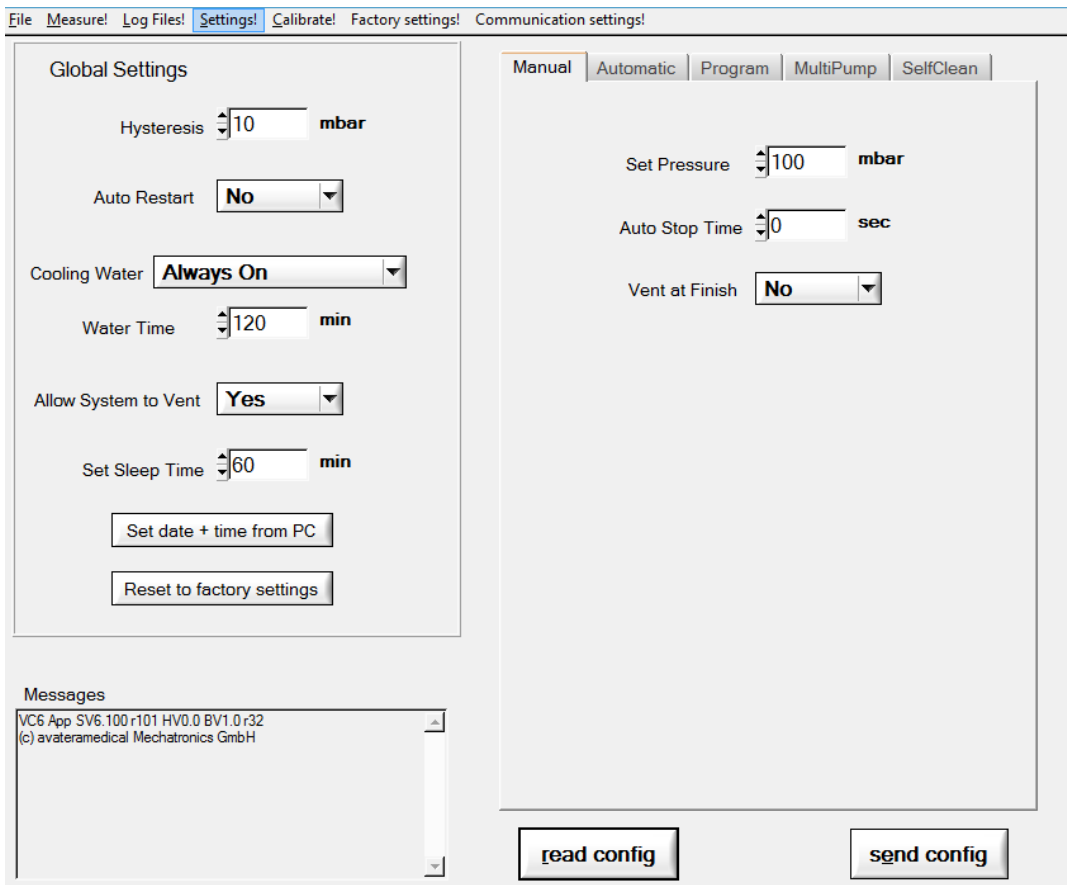

Left side of the screen:	Right side of the screen:
System settings for the control system	Settings of the values for the individual operating modes via the tabs: <ul style="list-style-type: none"> <li>- Manual</li> <li>- Automatic</li> <li>- Program</li> <li>- MultiPump</li> <li>- SelfClean</li> </ul>

For detailed information, see section 6.2 Operating modes and system settings.



## 6.4.7 Calibrate

The calibration can be done here just like on the end device. A two-point calibration with comparison measurement device can be performed.

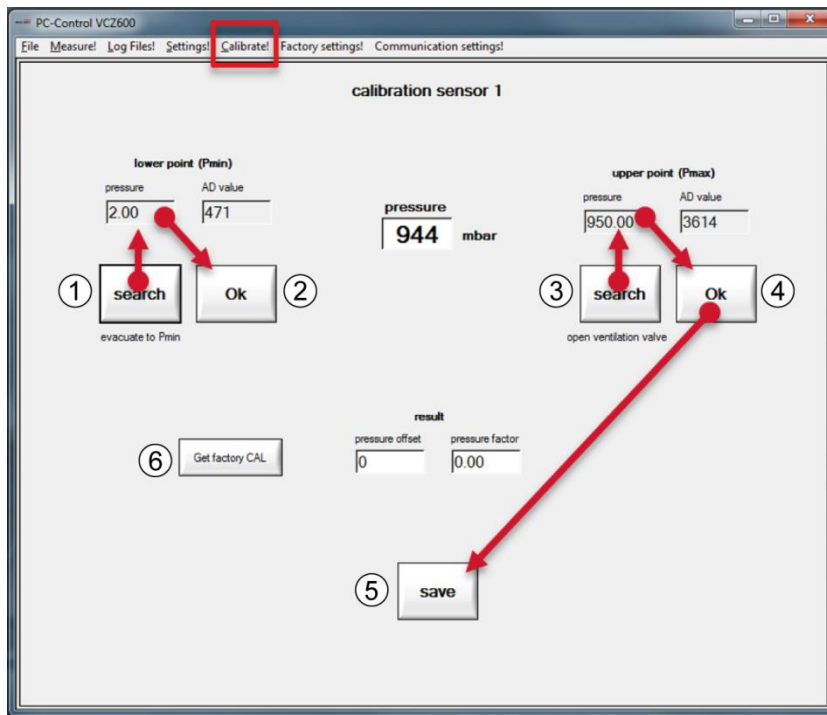

### Procedure

1. Evacuate the system for the lower point using the **search** lower point (Pmin) (1).
2. Take over the value with **Ok** (2) when the pressure stops dropping.
3. Ventilate the system for the upper point using the **search** upper point (Pmax) (3).
4. Take over the value with **Ok** (4) when the pressure stops rising.
5. Take over the settings with **save** (5). The calculated calibration coefficients are displayed.

Calibration with atmospheric pressure:	Calibration with low pressure (ultimate pressure):
The diaphragm pump is switched off	The diaphragm pump is switched on
The ventilation valve is open	The ventilation valve is closing
The vacuum control valve is closed	The vacuum control valve is opening
Sensor exposed to the ambient pressure	Sensor exposed to the ultimate pressure

## Operation

With **Get factory CAL** (6), the factory calibration can be loaded. The factory calibration cannot be changed by the user.

CALIBRATION	
	<ul style="list-style-type: none"><li>▶ Within the vacuum controller, one pair of variables (private and public) for the calibration of the pressure sensor are saved.</li><li>▶ The private variables correspond to the factory settings and can only be set by WELCH Quality or WELCH Service.</li><li>▶ The public variables can be set by the user and</li><li>▶ override the factory calibration.</li><li>▶ The "Reset to factory settings" function</li><li>▶ (see section 6.3.3 <i>Reset to factory settings</i>) is used to reset the factory calibration.</li></ul>

### 6.4.8 Firmware update

You will find the Firmware update function under the menu element File. The current version of the firmware is available on [www.gardnerdenver.com/de-de/welch](http://www.gardnerdenver.com/de-de/welch) in the "Service" menu → download area.

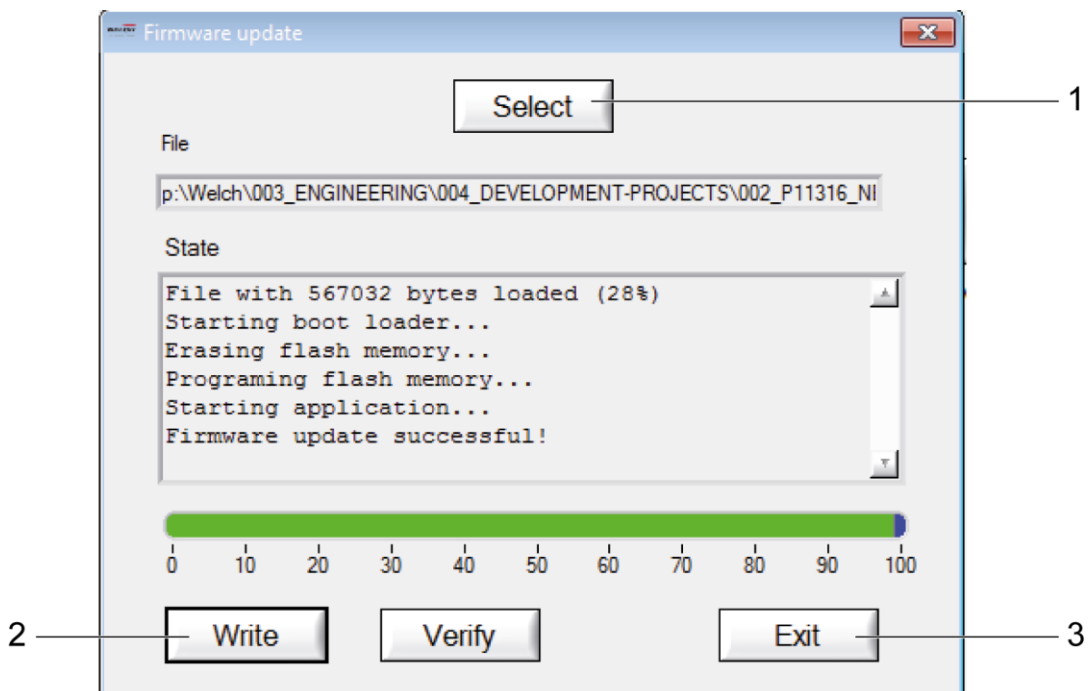

#### Procedure

1. Select the firmware file \*.hex with **Select** (1).
2. Perform the update with **Write** (2). After a successful upload, you will see the message "**Firmware update successful**".
3. Exit the menu with **Exit** (3).



## 6.5 Solvents table

	<b>OPERATING MODE</b>
	▶ <b>The selection of the pressure parameter via the solvents table is only performed in the Manual and Program operating modes.</b>

1. On the navigation bar, select the operating mode using the rotary encoder.
2. In the selected operating mode, select the "Set pressure" parameter.
3. In the button bar, press the PMIN button. The table for selecting the pressure parameters appears:

Name	CAS no.	Vapor pressure/p [mbar] at 40 °C
1,1,2,2,-TeCA	630-20-6	35
1,2,-Dichlorethan	107-06-2	210
1,2,-Dichlorethylen (c)	156-59-2	479
1,2,-Dichlorethylen (t)	156-60-5	751
2-Methyl-2-Propanol	75-65-0	130
3-Methyl-1-Butanol	123-51-3	14
Aceton	67-64-1	556
Benzol	71-43-2	236
Chlorbenzol	108-90-7	36
Chloroform	67-66-3	474
Cyclohexan	110-82-7	235
Diisopropylether	108-20-3	375
Dioxan	123-91-1	107
DMF	68-12-2	11
Ethanol	64-17-5	175
Ethylacetat	141-78-6	240
Ethylmethylketon	78-93-3	243
Heptan	142-82-5	120
Hexan	110-54-3	335
Isopropylalkohol	67-63-0	137
Methanol	67-56-1	337
Methylchloroform	71-55-6	300
n-Butanol	71-36-3	25
n-Pentanol	71-41-0	11
n-Propylalkohol	71-23-8	67
Pentachlorethan	76-01-7	13
p-Xylol	106-42-3	25
Tetrachlorethylen	127-18-4	53
Tetrachlormethan	56-23-5	271
Tetrahydrofuran	109-99-9	402
Toluol	108-88-3	77
Trichlorethylen	79-01-6	183
Wasser	7732-18-5	72

## 7 Elimination of operating faults

 <b>OPERATING FAULTS IN DEVICE</b>	
	<ul style="list-style-type: none"> <li>▶ <b>Adhere to the instructions and notes in section 8 Maintenance!</b></li> <li>▶ <b>To eliminate the operating faults within the device, the instructions and notes in section 8 Maintenance and section Fehler! Verweisquelle konnte nicht gefunden werden. Fehler! Verweisquelle konnte nicht gefunden werden. must be adhered to.</b></li> </ul>

### Authorization to eliminate operating faults

See section 2.2.2 *Overview of the responsibilities.*

1: User/(1): specially trained users only

2: Specialized personnel

3: Manufacturer



Type of error	Cause	Measure	Authorized
<b>No display</b>	There is no power	Check the correct connection of the power cable (external), fuse	<b>1</b>
		Internal check of electrical components (e.g. power supply unit)	<b>2, 3</b>
	Faulty display/control electronics	Replacement	<b>3</b>
<b>Vacuum pump does not start up</b>	There is no power.	Check the correct connection of the power cable (external), fuse	<b>1</b>
	Motor defective	Replacement	<b>3</b>
	Faulty pump unit	Repair or replace	<b>2,3</b>
<b>Pressure set-point is not reached or not reached sufficiently fast (vacuum pump turns continuously with maximum rotational speed)</b>	Pneum. connectors/connections or glass apparatuses are leaky	Identify leaks and seal them; replace damaged components where necessary	<b>1</b>
	Internal pneum. connections are leaky	Check the hose connections between the pump heads; replace the hoses and screw fittings where necessary	<b>2, 3</b>
	Contamination of the internal components of the vacuum pump, e.g. valves	Clean with the self-cleaning operating mode; see section 6.2.5 <i>Operating mode 5 Self-cleaning</i>	<b>1</b>
	Faulty diaphragms or valves	Replace the diaphragms/valves; see section 8.3 <i>Repairs by the manufacturer</i>	<b>2, 3</b>
	Vacuum application too large or vacuum pump capacity too small	Adapt the vacuum application to the characteristic data of the device	<b>2</b>
	Evaporation rate too high	Reduce evaporation rate	<b>1</b>

## Elimination of operating faults

Type of error	Cause	Measure	Authorized
<b>Water valve does not switch despite display</b>	Faulty valve (mechanical/electrical)	Exchange the water valve; see section 4.8 <i>Accessories (options)</i>	<b>1</b>
<b>It is not possible to set the parameter</b>	Firmware error	Upload the current firmware	<b>1</b>
	Faulty electronics	Repair the device	<b>3</b>
<b>Vacuum controller cannot be set or programmed</b>	Faulty electronics/display	Repair or replace	<b>3</b>
<b>Incorrect language</b>	System setting set incorrectly	Set the language: first option under system settings; see section 6.2.6 <i>System settings</i>	<b>1</b>
		Reset the device; see section 6.2.6 <i>System settings</i> ; 10 – <i>Reset to factory settings</i>	<b>1</b>
<b>Access locked ADMIN or USER</b>	ADMIN or possibly USER password is set	Have unlocked by authorized person; see sections 6.2.6 <i>System settings</i> and 6.3.1 <i>Access control</i>	<b>(1), 2</b>
<b>No access to vacuum controller via PC</b>	No connection to PC	Check cable connection of the data connection and check connection status under <b>System setting → Network → Status "connected"</b>	<b>1</b>
	IP addressing not correct	Check the IP address; if necessary, set DHCP to "dynamic", see section 6.2.6 <i>System settings</i> ; 7 – <i>Network</i>	<b>1</b>
<b>Incorrect actual value of pressure</b>	Wrong calibration	Recalibrate the pressure sensor; see section 6.2.6 <i>System settings</i> ; 3 – <i>Control systems/calibration</i>	<b>1</b>
		Reset the device; see section 6.2.6 <i>System settings</i> ; 10 – <i>Reset to factory settings</i>	<b>1</b>

	<b>REPAIR</b>
	<p>► Repairs may only be performed by specialists or by the manufacturer; see section 8 <i>Maintenance</i>.</p>

## 8 Maintenance

 	 <b>WARNING</b>
	<ul style="list-style-type: none"> <li>▶ Health hazard from hazardous materials!</li> <li>▶ Components in contact with media may be contaminated in applications using hazardous materials.</li> <li>▶ Affected components must be decontaminated prior to maintenance (service, inspection, repair); further protection measures may need to be taken if necessary.</li> <li>▶ The operator must ensure that decontamination and protection measures are performed (see sections 2.3 <i>Protective measures</i> and 2.4.1 <i>Hazardous materials</i> in general).</li> </ul>

### 8.1 Service and inspection

	<b>SERVICE/INSPECTION</b>
	<ul style="list-style-type: none"> <li>▶ In applications using media that shorten the service life of materials, the device must be serviced regularly.</li> <li>▶ For safe operation of the device, the operator must create an application-specific service/inspection plan.</li> </ul>

#### General

- Check the tightness of the system regularly
- If necessary, replace seals, e.g. safety valve of the emission condenser
- Check that all connections are firmly seated
- Check that the glass apparatuses are undamaged
- Check that the vacuum pump is functional, e.g. abnormal operating noises
- Clean the components in contact with media (connections, valves, sensors), as needed, with a suitable solvent (e.g. acetone)
- Empty the glass fluid catchpot in time. Adhere to the disposal regulations for hazardous materials.

#### Service by cleaning

	<b>SELF-CLEANING</b>
	<ul style="list-style-type: none"> <li>▶ The device features an operating mode for self-cleaning of the device; see section 6.2.5 <i>Operating mode 5 Self-cleaning</i>.</li> </ul>

Depending on contamination, components in contact with media (connections, valves, sensors) must be cleaned at regular intervals with a suitable solvent (e.g. acetone).

## 8.2 Repairs by the operator

	<b>AUTHORIZATION</b>
	<ul style="list-style-type: none"> <li>▶ Repair work may only be performed by specialists or specially trained users.</li> <li>▶ The operator is responsible for performing the repairs properly.</li> <li>▶ Heed the safety instructions; see section 2.2.2 <i>Overview of the responsibilities!</i></li> </ul>

### 8.2.1 Opening the device

	<b>SEPARATOR</b>
	<ul style="list-style-type: none"> <li>▶ The separators must be removed before the retainer bracket is removed; see section 4.3.1 <i>Front of the device</i> Fig. 4.1.</li> <li>▶ Note the fill level of the separator.</li> </ul>

	<b>PULL THE POWER PLUG</b>
	<ul style="list-style-type: none"> <li>▶ All work on the open device must be performed with the device de-energized.</li> <li>▶ Pull the power plug before opening the device.</li> <li>▶ Heed the safety instructions; see section 2.4.3 <i>Electricity!</i></li> </ul>

	<b>ATTENTION</b>
	<ul style="list-style-type: none"> <li>▶ The printed circuit board and display can be destroyed by electrostatic discharge when the device is opened.</li> </ul>

#### Instructions for opening the device

1. Release the pneum. connections on the intake and pressure sides (Fig. 8.1).
2. Release and remove the glass apparatuses.
3. Release the retainer bracket fasteners on the right and left (Fig. 8.2).
4. Remove the retainer bracket.
5. Unscrew the angle fittings and extensions (Fig. 8.3).
6. Release the 4 x M4 cross recessed screws on the underside (Fig. 8.4).
7. Pull the housing hood up, noting the cable routing.

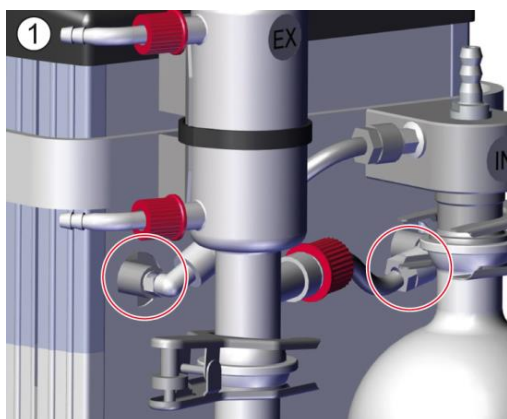

Fig. 8.1 – Glass apparatuses with pneum. connection on intake and pressure sides (front)

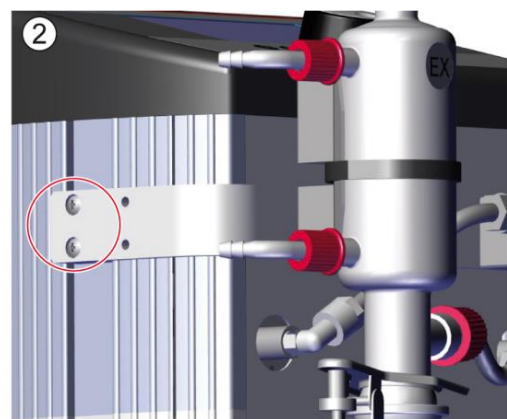

Fig. 8.2 – Retainer bracket fastener (left side)

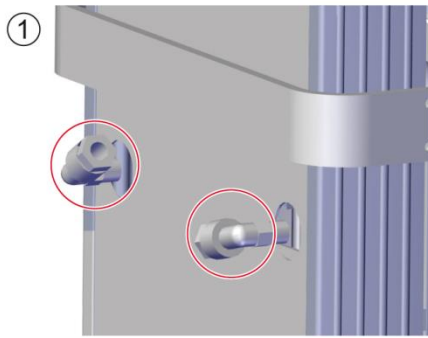

Fig. 8.3 – Angle fittings on intake/pressure sides

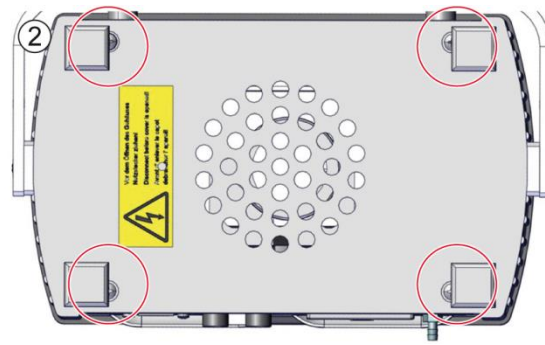

Fig. 8.4 – Housing shell fasteners

## 8.2.2 Replacing the components in the pump unit



### ORDER OPTION

► The replacement components for the pump unit can be ordered as a service set; see section 9.1 *Diaphragm pump service set*.

#### Instruction for disassembling the pump unit

See Fig. 8.5 and Fig. 8.6.

1. Release the clamps of the angle fittings (E).
2. Release the cross recessed screws (H).
3. Remove the pressure plates (G).
4. Remove the connection head (F).
5. Remove the O-rings (C) and the valves (D).
6. Remove the pump head (B).

**NOTE:** Only necessary for inspection/service of the diaphragms

7. Release the diaphragms (A) by turning counterclockwise.

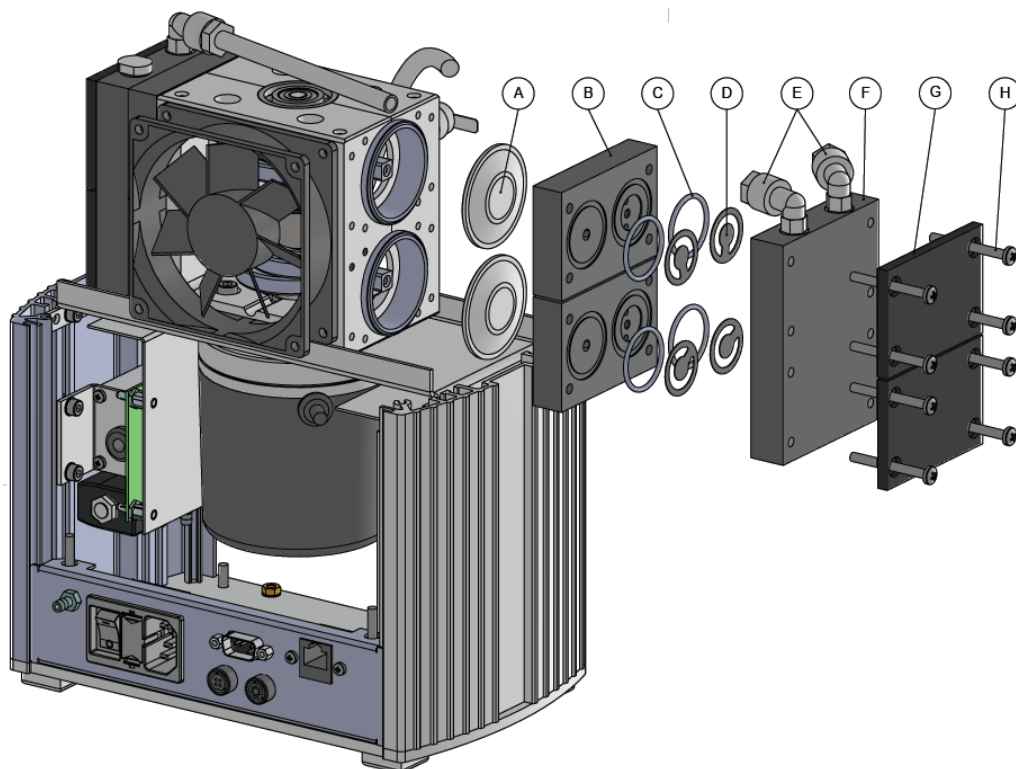
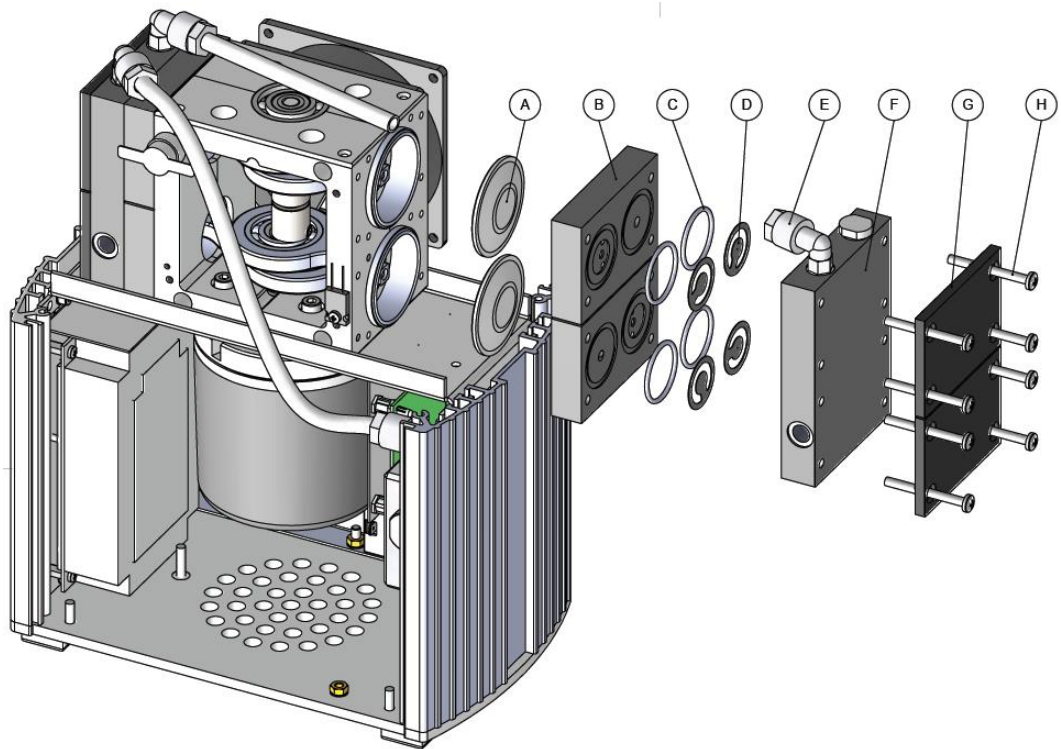

Fig. 8.5 – Exploded view of pump unit, 1st stage (view from rear left)





**Fig. 8.6 – Exploded view of pump unit, 2nd/3rd stage (view from front right)**

Pos.	Description
A	Diaphragms
B	Pump head
C	O-rings
D	Valves
E	Angle fittings
F	Connection head
G	Pressure plates
H	Cross recessed screws

## 8.2.3 Installing the pump unit

The pump unit is assembled in the reverse order of disassembly; see the section on replacing components in the pump unit 8.2.2 *Replacing the components in the pump unit*.



### PUMP UNIT INSTALLATION

► Align the pump unit (diaphragm) horizontally.

#### Remarks

See figures 8.3 and 8.4.

- Press the diaphragms (A) toward the inside so they are concave.
- Insert the O-rings (C) into the circular grooves of the pump head (B).
- Center the valves (D) in the O-rings (C). The smooth sides of the valves must face the sealing surface in the connection/pump head.
- Note the valve arrangement; see figure 8.7
- Tighten the cross recessed screws with a torque of 3 Nm to 4 Nm.
- Seal the angle fittings again if necessary.
- Connect the hoses with a compression fitting.

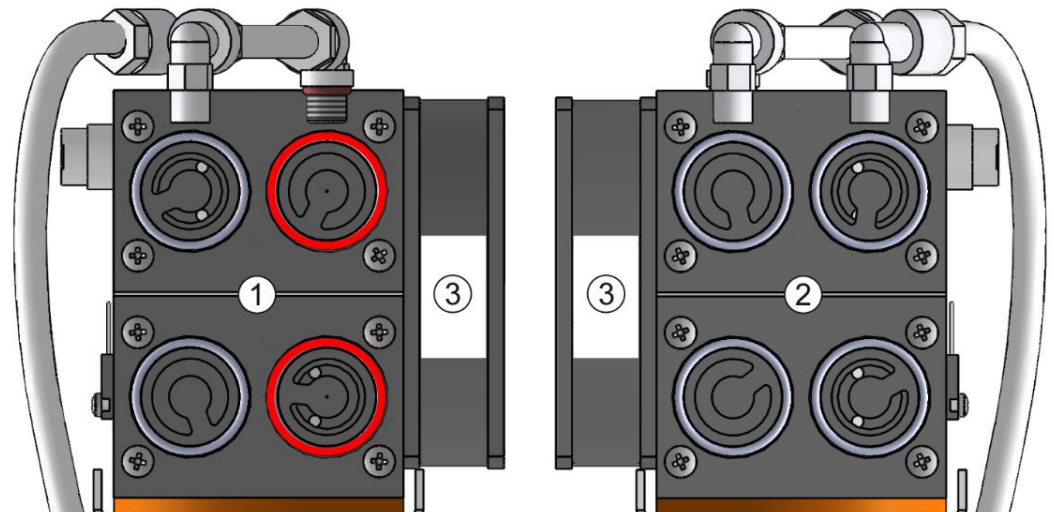



Fig. 8.7 – Valve arrangement: 1st stage (view from left), 2nd/3rd stage (view from right)

Pos.	Description
1	Valve arrangement 2nd/3rd stage 2 x valves, order no. 400656 2 x valves with drilled hole 400656-4 (red marking)
2	Valve arrangement 1st stage 4 x valves, order no. 4006564
3	Fan

## 8.2.4 Closing the device

Close the device in the reverse order of opening it; see section 8.2.1 *Opening the device*.

	<b>CABLE ROUTING</b>
	<ul style="list-style-type: none"> <li>▶ When closing the device, watch out for the cable routing. Cables must not become pinched or damaged when closing the device.</li> <li>▶ Devices with damaged cables are not permitted to be started up.</li> </ul>

## 8.3 Repairs by the manufacturer



	<b>SERVICE / REPAIR</b>
	<ul style="list-style-type: none"> <li>▶ The repair is only performed if there is a completely filled-out damage report; see section 8.4 <i>Damage report</i>.</li> <li>▶ The specification of the contamination or the complete cleaning is a legal component of the contract.</li> </ul>

Transfer a faulty device to the manufacturer, see section 9.2 *Ordering and service contact*.

## 8.4 Damage report

The damage report form is available for download on our website [www.gardnerdenver.com/de-de/welch](http://www.gardnerdenver.com/de-de/welch) in the "Service" menu → "Damage reports".

If you do not have access to the Internet, you can request the form from us, tel.: +49 3677 604 0.

  	<b>! WARNING</b>
	<ul style="list-style-type: none"> <li>▶ Incompletely or incorrectly filled-out damage reports can endanger the service personnel!</li> <li>▶ Make complete statements in the damage report, especially with regard to a possible contamination of the components in contact with media.</li> </ul>

## 8.5 Disposal

	<b>NOTE</b>
	<ul style="list-style-type: none"> <li>▶ Incorrect disposal can cause environmental damage.</li> <li>▶ The device must be disposed of in accordance with legal regulations as per Directive 2012/19/EU.</li> <li>▶ Contaminated devices must be decontaminated according to the legal regulations.</li> </ul>

## 9 Spare parts overview

The spare parts list includes all spare parts with the required order information.  
When placing your order, specify the name, quantity, serial number and order number!

	<b>LIABILITY</b>
	▶ <b>We are not liable for damage due to the installation of other parts than those provided by the manufacturer, Gardner Denver Thomas GmbH.</b>

### 9.1 Diaphragm pump service set

Designation	Order numbers
<b>Complete service set</b>	<b>402044</b>
O-rings, valves, diaphragms, see section 8.2.2 <i>Replacing the components in the pump unit</i>	
<b>Emission condenser</b>	<b>700183-11</b>
<b>Separator</b>	
Spherical joint clip, stainless steel, for KS 35	828857-35
Round-bottom flask 500 ml KS 35	828845
<b>Attachments</b>	
PTFE tube 8 x 1 mm	828331
Hose nozzle PP, DN8-G1/4"	710798-06
Straight fitting PVDF 8-1/8"	829919
Angle fitting	829936-1
O-ring EPDM, Ø 8 x 2	829210-3

### 9.2 Ordering and service contact

**Manufacturer:**

Gardner Denver Thomas GmbH  
Am Vogelherd 20  
98693 Ilmenau  
Germany

Tel.: +49 3677 604 0

Fax: +49 3677 604 131

E-mail: [welch.emea@gardnerdenver.com](mailto:welch.emea@gardnerdenver.com)

Web: [www.gardnerdenver.com/de-de/welch](http://www.gardnerdenver.com/de-de/welch)

Customer support +49 3677 604 0

## 10 Appendix

### 10.1 EU declaration of conformity

EU declaration of conformity  
Translation of the original declaration (EN)

Gardner Denver Thomas GmbH  
Am Vogelherd 20  
98693 Ilmenau  
Germany



We hereby declare under our own responsibility that the following product, based on its design and construction and on the documents we have put into circulation corresponds to the EC directives and standards listed below. In case of a change to the product not agreed upon with us, this declaration is no longer valid.

Product description	
Type	Labor-vacuum-system
Designation	LVS 105 T – 10 ef +
Item no.	124184

This product meets the following directives and standards	
2006/42/EC	Machinery directive
2014/30/EU	Directive relating to electromagnetic compatibility (EMC)
2011/65/EU	Directive on the restriction of the use of certain hazardous substances in electrical and electronic equipment (RoHS)

Applicable harmonized standards	
EN ISO 12100:2010	Safety of machines - General principles for design - risk assessment and risk reduction
EN 61010-1:2010	Safety requirements for electrical measurement, control and laboratory use - Part 1: General requirements
EN 1012-2:1996	Compressors and vacuum pumps - Safety requirements - Part 2: Vacuum pumps
EN 61326-1:2013	Electrical measurement, control and laboratory use - EMC requirements - Part 1: General requirements
EN IEC 63000:2018	Technical documentation for assessment of electrical and electronic devices with regard to the limitation of hazardous materials

Authorized representative headquartered in the European Community and person who is authorized to create the technical documents.

Place, date: Ilmenau, 11.07.2019

**Robert Götz**  
(Plant manager)

**Gardner Denver Thomas GmbH**  
**Am Vogelherd 20**  
**98693 Ilmenau / Germany**

Tel.: +49 3677 604 0

Fax: +49 3677 604 131

E-mail: [welch.emea@gardnerdenver.com](mailto:welch.emea@gardnerdenver.com)

Web: [www.gardnerdenver.com/de-de/welch](http://www.gardnerdenver.com/de-de/welch)

## 10.2 Notes



**Gardner Denver Thomas GmbH**  
Am Vogelherd 20  
98693 Ilmenau  
Germany



# Revisionsübersicht

Interne Dokumentation → NICHT Übersetzten → NICHT als PDF Kompilieren

Rev	Editor	Date	S. / Kap.	Description	Freigabe Dat.	Freigabe durch
00	RLe	11-07-19		Initial creation	12-02-2020	RLe
01						
...						

Last back-up	Storage location
13.03.2020 Grimbs Manfred	W:\0300-0699\332_Gardner Denver Thomas\332_20001_Ü_LVS105\3_ÜM\von_Ü\124184_BA_LVS105T_Rev00_2020-02-13.doc